



Online Continuing Education for Professional Engineers
Since 2009

In-Situ Geotechnical Tests

PDH Credits:

4 PDH

Course No.:

IGT101

Publication Source:

US DOT: FHWA

**"Subsurface Investigations - Geotechnical Site
Characterization Reference Manual: CH. 5, In-situ
Geotechnical Tests"**

Pub. # FHWA NHI-01-031

Release Date:

May 2002

DISCLAIMER:

All course materials available on this website are not to be construed as a representation or warranty on the part of Online-PDH, or other persons and/or organizations named herein. All course literature is for reference purposes only, and should not be used as a substitute for competent, professional engineering council. Use or application of any information herein, should be done so at the discretion of a licensed professional engineer in that given field of expertise. Any person(s) making use of this information, herein, does so at their own risk and assumes any and all liabilities arising therefrom.

CHAPTER 5.0

IN-SITU GEOTECHNICAL TESTS

Several in-situ tests define the geostatigraphy and obtain direct measurements of soil properties and geotechnical parameters. The common tests include: standard penetration (SPT), cone penetration test (CPT), piezocone (CPTu), flat dilatometer (DMT), pressuremeter (PMT), and vane shear (VST). Each test applies different loading schemes to measure the corresponding soil response in an attempt to evaluate material characteristics, such as strength and/or stiffness. Figure 5-1 depicts these various devices and simplified procedures in graphical form. Details on these tests will be given in the subsequent sections.

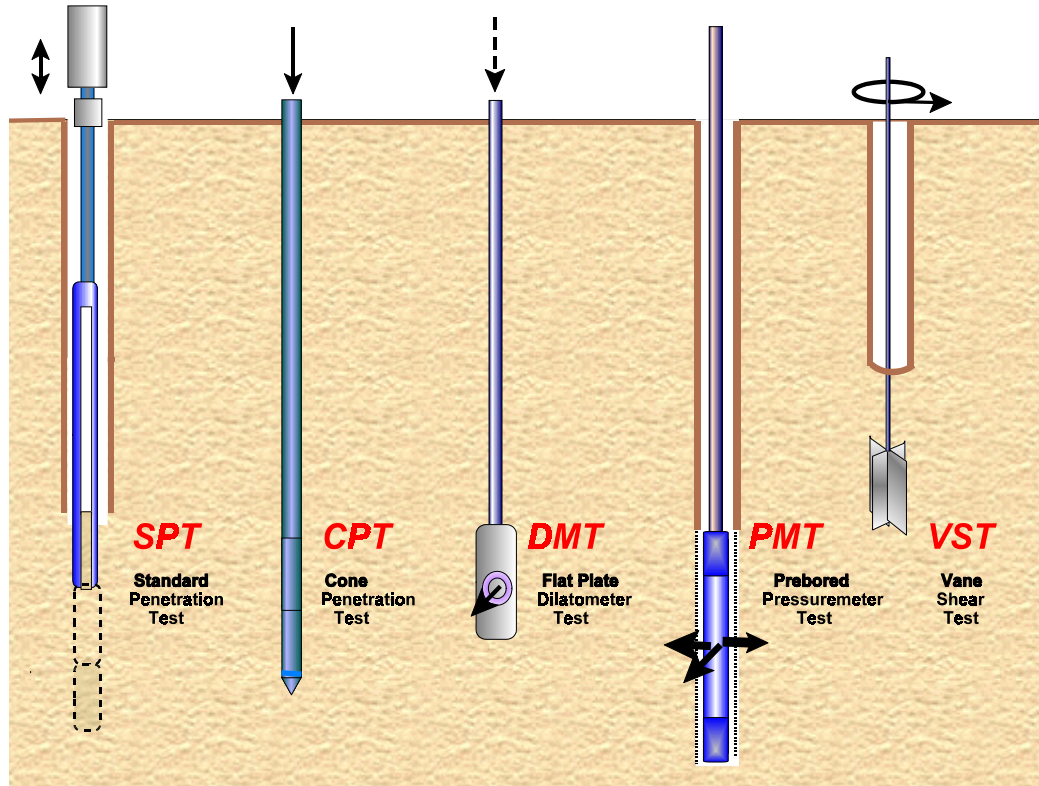

Figure 5-1. Common In-Situ Tests for Geotechnical Site Characterization of Soils.

Boreholes are required for conducting the SPT and normal versions of the PMT and VST. A rotary drilling rig and crew are essential for these tests. In the case of the CPT, CPTU, and DMT, no boreholes are needed, thus termed “direct-push” technologies. Specialized versions of the PMT (i.e., full-displacement type) and VST can be conducted without boreholes. As such, these may be conducted using either standard drill rigs or mobile hydraulic systems (cone trucks) in order to directly push the probes to the required test depths. Figure 5-2 shows examples of the truck-mounted and track-mounted systems used for production penetration testing. The enclosed cabins permit the on-time scheduling of in-situ testing during any type of weather. A disadvantage of direct-push methods is that hard cemented layers and bedrock will prevent further penetration. In such cases, borehole methods prevail as they may advance by coring or noncoring techniques. An advantage of direct-push soundings is that no cuttings or spoil are generated.



Figure 5-2. Direct-Push Technology: (a) Truck-Mounted and (b) Track-Mounted Cone Rigs.

5.1 STANDARD PENETRATION TEST

The standard penetration test (SPT) is performed during the advancement of a soil boring to obtain an approximate measure of the dynamic soil resistance, as well as a disturbed drive sample (split barrel type). The test was introduced by the Raymond Pile Company in 1902 and remains today as the most common in-situ test worldwide. The procedures for the SPT are detailed in ASTM D 1586 and AASHTO T-206.

The SPT involves the driving of a hollow thick-walled tube into the ground and measuring the number of blows to advance the split-barrel sampler a vertical distance of 300 mm (1 foot). A drop weight system is used for the pounding where a 63.5-kg (140-lb) hammer repeatedly falls from 0.76 m (30 inches) to achieve three successive increments of 150-mm (6-inches) each. The first increment is recorded as a “seating”, while the number of blows to advance the second and third increments are summed to give the N-value (“blow count”) or SPT-resistance (reported in blows/0.3 m or blows per foot). If the sampler cannot be driven 450 mm, the number of blows per each 150-mm increment and per each partial increment is recorded on the boring log. For partial increments, the depth of penetration is recorded in addition to the number of blows. The test can be performed in a wide variety of soil types, as well as weak rocks, yet is not particularly useful in the characterization of gravel deposits nor soft clays. The fact that the test provides both a sample and a number is useful, yet problematic, as one cannot do two things well at the same time.

ADVANTAGES

- Obtain both a sample & a number
- Simple & Rugged
- Suitable in many soil types
- Can perform in weak rocks
- Available throughout the U.S.

DISADVANTAGES

- Obtain both a sample & a number*
- Disturbed sample (index tests only)
- Crude number for analysis
- Not applicable in soft clays & silts
- High variability and uncertainty

Note: *Collection simultaneously results in poor quality for both the sample and the number.

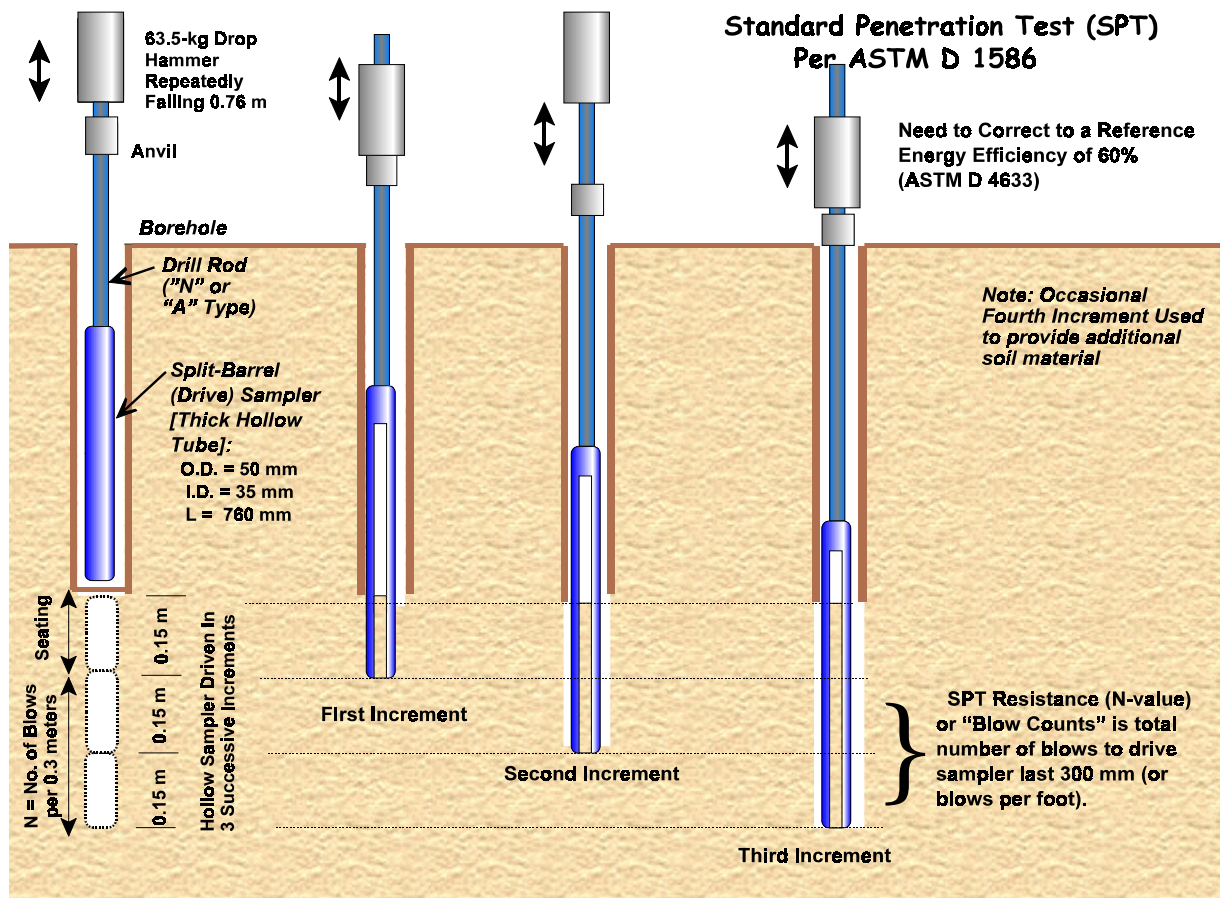

Figure 5-3. Sequence of Driving Split-Barrel Sampler During the Standard Penetration Test.

The SPT is conducted at the bottom of a soil boring that has been prepared using either flight augers or rotary wash drilling methods. At regular depth intervals, the drilling process is interrupted to perform the SPT. Generally, tests are taken every 0.76 m (2.5 feet) at depths shallower than 3 meters (10 feet) and at intervals of 1.5 m (5.0 feet) thereafter. The head of water in the borehole must be maintained at or above the ambient groundwater level to avoid inflow of water and borehole instability.

In current U.S. practice, three types of drop hammers (donut, safety, and automatic) and four types of drill rods (N, NW, A, and AW) are used in the conduct of the SPT. The test in fact is highly-dependent upon the equipment used and operator performing the test. Most important factor is the energy efficiency of the system. The theoretical energy of a free-fall system with the specified mass and drop height is 48 kg-m (350 ft-lb), but the actual energy is less due to frictional losses and eccentric loading. A rotating cathead and rope system is commonly used and their efficiency depends on numerous factors well-discussed in the open literature (e.g., Skempton, 1986), including: type of hammer, number of rope turns, conditions of the sheaves and rotating cathead (e.g., lubricated, rusted, bent, new, old), age of the rope, actual drop height, vertical plumbness, weather and moisture conditions (e.g., wet, dry, freezing), and other variables. Trends in recent times are towards the use of automated systems for lifting and dropping the mass in order to minimize these factors.

A calibration of energy efficiency for a specific drill rig & operator is recommended by ASTM D-4633 using instrumented strain gages and accelerometer measurements in order to better standardize the energy levels. Standards of practice varies from about 35% to 85% with cathead systems using donut or safety hammers, but averages about 60% in the United States. The newer automatic trip-hammers can deliver between 80 to 100% efficiency, but specifically depends on the type of commercial system. If the efficiency is measured (E_f), then the energy-corrected N-value (adjusted to 60% efficiency) is designated N_{60} and given by:

$$N_{60} = (E_f/60) N_{meas} \quad (5-1)$$

The measured N-values should be corrected to N_{60} for all soils, if possible. The relative magnitudes of corrections for energy efficiency, sampler lining, rod lengths, and borehole diameter are given by Skempton (1986) and Kulhawy & Mayne (1990), but only as a general guide. It is mandatory to measure E_f to get the proper correction to N_{60} .

The efficiency may be obtained by comparing either the work done ($W = F \cdot \Delta =$ force times displacement) or the kinetic energy ($KE = \frac{1}{2}mv^2$) with the potential energy of the system ($PE = mgh$), where $m =$ mass, $v =$ impact velocity, $g = 9.8 \text{ m/s}^2 = 32.2 \text{ ft/s}^2 =$ gravitational constant, and $h =$ drop height. Thus, the energy ratio (ER) is defined as the ratio of $ER = W/PE$ or $ER = KE/PE$. It is important to note that geotechnical foundation practice and engineering usage based on SPT correlations have been developed on the basis of the standard-of-practice, corresponding to an average ER . 60 percent.

Figure 5-4 exemplifies the need for correcting N-values to a reference energy level where the successive SPTs were conducted by alternating use of donut and safety hammers in the same borehole. The energy ratios were measured for each test and gave $34 < ER < 56$ for the donut hammer (average = 45%) and ranged $55 < ER < 69$ for the safety hammer (average = 60%) at this site. The individual trends for the measured N-values from donut and safety hammers are quite apparent in Figure 5-4a, whereas a consistent profile is obtained in Figure 5-4b once the data have been corrected to $ER = 60\%$.

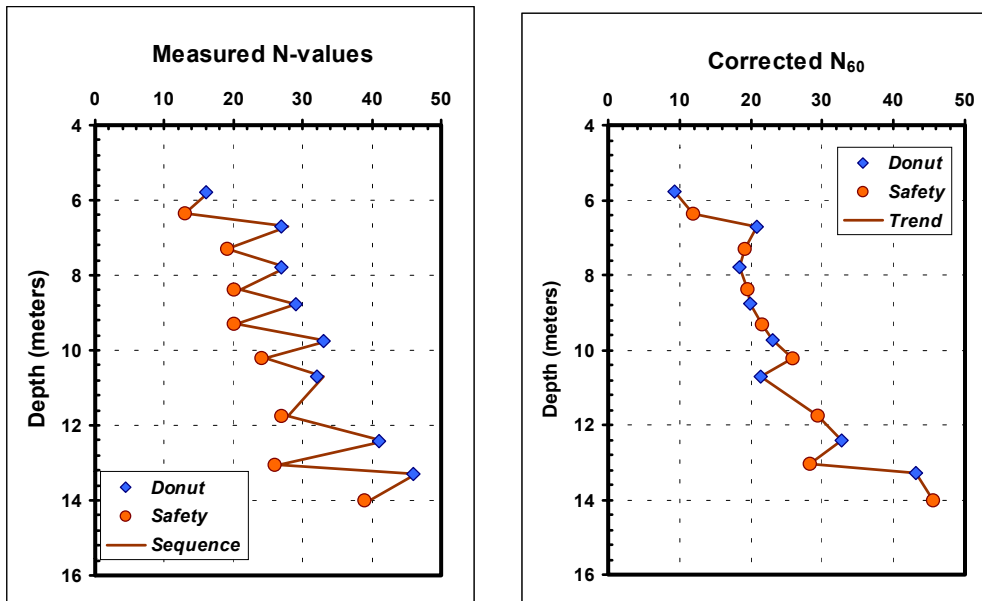

Figure 5-4. SPT-N values from (a) Uncorrected Data and (b) Corrected to 60% Efficiency. (Data modified after Robertson, et al. 1983)

In some correlative relationships, the energy-corrected N_{60} value is further normalized for the effects of overburden stress, designated $(N_1)_{60}$, as described in Sections 9.3 and 9.4. The $(N_1)_{60}$ involves evaluations in clean sands for interpretations of relative density, friction angle, and liquefaction potential.

The SPT can be halted when 100 blows has been achieved or if the number of blows exceeds 50 in any given 150-mm increment, or if the sampler fails to advance during 10 consecutive blows. SPT refusal is defined by penetration resistances exceeding 100 blows per 51 mm (100/2"), although ASTM D 1586 has re-defined this limit at 50 blows per 25 mm (50/1"). If bedrock, or an obstacle such as a boulder, is encountered, the boring may be further advanced using diamond core drilling or noncore rotary methods (ASTM D 2113; AASHTO T 225) per the discretion of the geotechnical engineer. In certain cases, this SPT criterion may be utilized to define the top of bedrock within a particular geologic setting where boulders are not of concern or not of great impact on the project requirements.

5.2 CONE PENETRATION TESTING (CPT)

The cone penetration test is quickly becoming the most popular type of in-situ test because it is fast, economical, and provides continuous profiling of geostratigraphy and soil properties evaluation. The test is performed according to ASTM D-3441 (mechanical systems) and ASTM D 5778 (electric and electronic systems) and consists of pushing a cylindrical steel probe into the ground at a constant rate of 20 mm/s and measuring the resistance to penetration. The standard penetrometer has a conical tip with 60° angle apex, 35.7-mm diameter body (10-cm² projected area), and 150-cm² friction sleeve. The measured point or tip resistance is designated q_c and the measured side or sleeve resistance is f_s . The ASTM standard also permits a larger 43.7-mm diameter shell (15-cm² tip and 200-cm² sleeve).

The CPT can be used in very soft clays to dense sands, yet is not particularly appropriate for gravels or rocky terrain. The pros and cons are listed below. As the test provides more accurate and reliable numbers for analysis, yet no soil sampling, it provides an excellent complement to the more conventional soil test boring with SPT measurements.

ADVANTAGES of CPT

- Fast and continuous profiling
- Economical and productive
- Results not operator-dependent
- Strong theoretical basis in interpretation
- Particularly suitable for soft soils

DISADVANTAGES of CPT

- High capital investment
- Requires skilled operator to run
- Electronic drift, noise, and calibration.
- No soil samples are obtained.
- Unsuitable for gravel or boulder deposits*

*Note: Except where special rigs are provided and/or additional drilling support is available.

The history of field cone penetrometers began with a design by the Netherlands Department of Public Works in 1930. This "Dutch" penetrometer was a mechanical operation using a manometer to read loads and paired sets of inner & outer rods pushed in 20-cm intervals. In 1948, electric cones permitted continuous measurements to be taken downhole. In 1965, the addition of sleeve friction measurements allowed an indirect means for classifying soil types. Later, in 1974, the electric cone was combined with a piezoprobe to form the first piezocone penetrometer. Most recently, additional sensors have been added to form specialized devices such as the resistivity cone, acoustic cone, seismic cone, vibrocone, cone pressuremeter, and lateral stress cone. Also, signal conditioning, filtering, amplification, and digitization have been incorporated within the probe itself, thus making electronic cones (Mayne, et al. 1995).

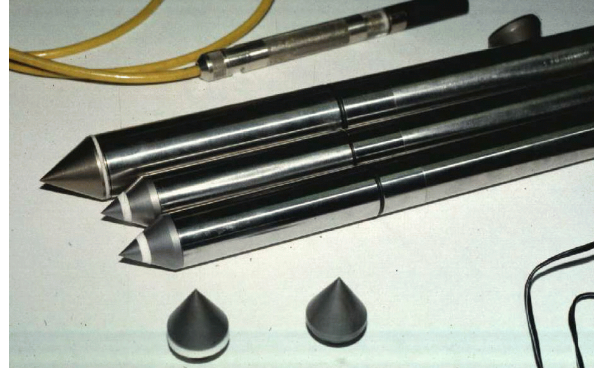

Figure 5-5. Various Cone Penetrometers Including Electric Friction and Piezocone Types.

Most electric/electronic cones require a cable that is threaded through the rods to connect with the power supply and data acquisition system at the surface. An analog-digital converter and pentium notebook are sufficient for collecting data at approximate 1-sec intervals. Depths are monitored using either a potentiometer (wire-spoiled LVDT), depth wheel that the cable passes through, or ultrasonics sensor. Systems can be powered by voltage using either generator (AC) or battery (DC), or alternatively run on current. New developments include: (1) the use of audio signals to transmit digital data up the rods without a cable and (2) memocone systems where a computer chip in the penetrometer stores the data throughout the sounding.

Piezocone Penetration Testing (PCPT or CPTu)

Piezocones are cone penetrometers with added transducers to measure penetration porewater pressures during the advancement of the probe. In clean sands, the measured penetration pore pressures are nearly hydrostatic ($u_{meas} \approx u_o$) because the high permeability of the sand permits immediate dissipation. In clays, however, the undrained penetration results in the development of high excess porewater pressures above hydrostatic. These excess u can be either positive or negative, depending upon the specific location of the porous element (filter stone) along the cone probe. If the penetration is arrested, the decay of porewater pressures can be monitored with time and used to infer the rate of consolidation and soil permeability.

The measurement of porewater pressures requires careful preparation of the porous elements and cone cavities to ensure saturation and reliable measurements of u during testing. Porous filter stones can be made of stone, ceramics, sintered steel or brass or copper, and plastic. Polypropylene is economical for replacement and discard for each sounding, particularly important if clogging or smearing is considered problematic. However, in certain soil types, the compressibility of the filter material can affect the measured results (Campanella & Robertson 1988). Although water can be used for saturation, glycerin or silicon offer a better means of penetrating through unsaturated zones to avoid losing cone saturation before encountering the groundwater table.

Commercial penetrometers have the porous element either midface (designated u_1 or u_1), or at the shoulder, just behind the cone tip (designated u_2 or u_2), as depicted in Figure 5-6. As a rule, measured porewater pressures are such that $u_1 > u_2$. For Type 1 piezocones, the measured porewater pressures are always positive. For Type 2 cones, however, measured u_2 are positive in soft to stiff clays, but are zero or negative in fissured overconsolidated clays and dense dilatant sands. The "standard" piezocone penetrometer has a shoulder position (u_2) because of a necessary correction for the measured tip stress q_c .

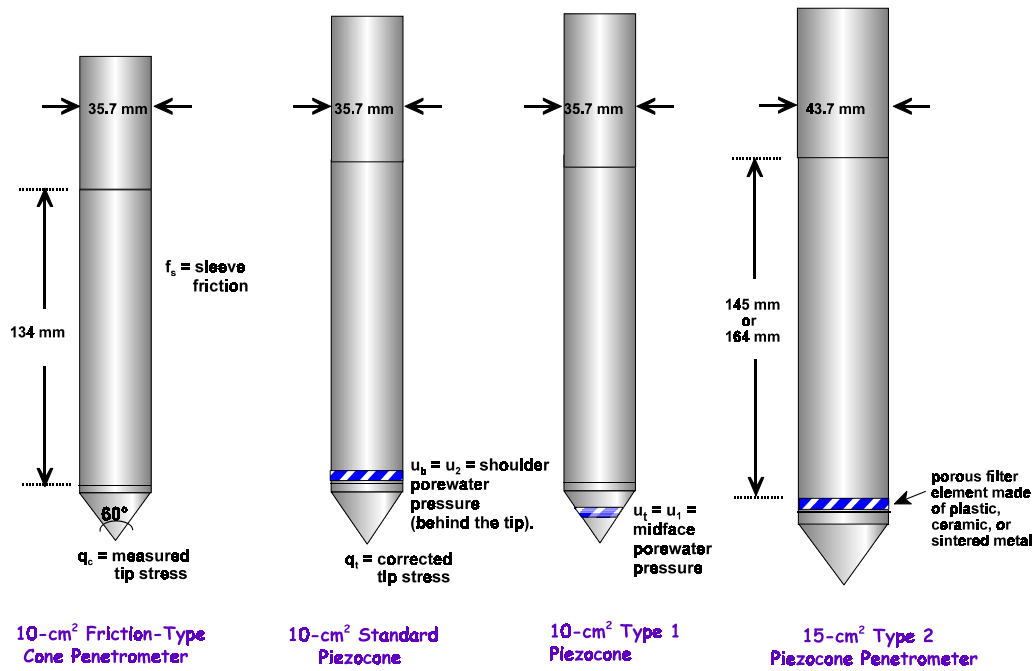

Figure 5-6. Geometry and Measurements Taken by Cone and Piezocone Penetrometers.

The measured cone resistance (q_c) must be corrected for porewater pressures acting on unequal areas of the cone tip. This correction is most important for soft to firm to stiff clays and silts and for very deep soundings where high hydrostatic pressures exist. Usually in sands, the correction is minimal because $q_c \gg u_2$. The corrected resistance is given by (Lunne, et al. 1997):

$$q_T = q_c + (1-a_n)u_2 \quad (5-2)$$

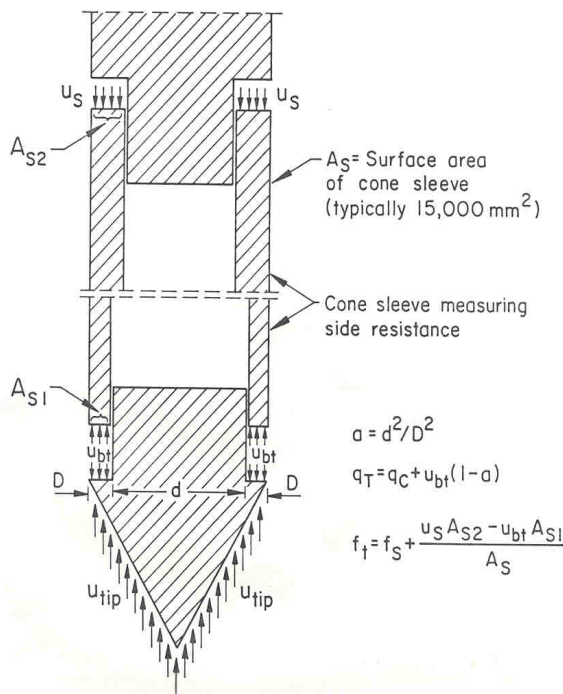

Figure 5-7. Correction Detail for Porewater Pressures Acting on Cone Tip Resistance.

where a_n = net area ratio determined from calibration of the cone in a triaxial chamber. Penetrometers with values of $a_n \leq 0.8$ are desired in order to minimize the corrections, yet provide sufficient steel wall thickness of the cylinder against buckling. Most 10-cm² commercial penetrometers have $0.75 < a_n \leq 0.82$ and many 15-cm² cones show $0.65 < a_n < 0.8$, yet several older models indicate values as low as $a_n = 0.35$. The value of a_n should be provided by the manufacturer. For a type 1 cone, the correction cannot be made reliably because an assumed conversion from u_1 to u_2 pressures must be made, but this depends on stress history, sensitivity, cementation, fissuring, and other effects (Mayne et al., 1990). In soils where the measured $u_2 \leq 0$ (or slightly negative), the use of a type 1 piezocone is warranted because the correction is negligible and better stratigraphic detailing of the subsurface profile is obtained.

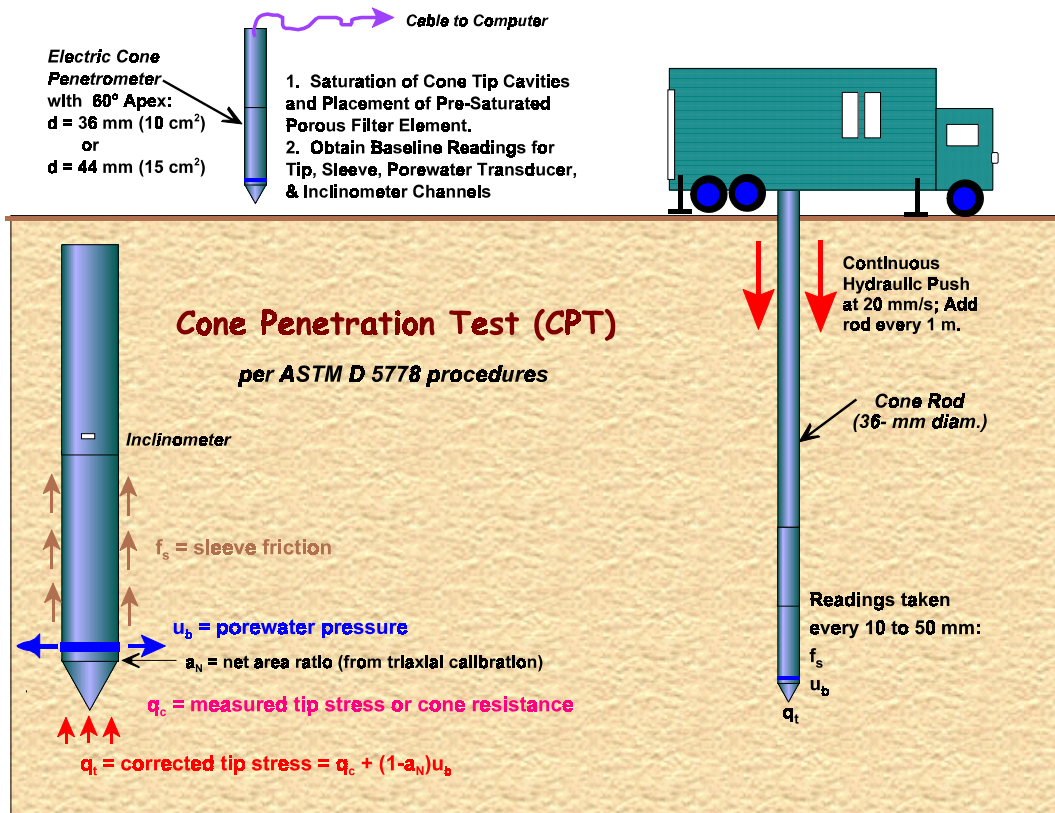

Figure 5-8. Procedures and Components of the Cone Penetration Test.

Baseline Readings

Prior to and after the conduct of an electric CPT sounding, it is very important to take initial baseline readings (“zeros”) of the separate channels before advancing the penetrometer. All commercial and research CPT systems require a baseline set of readings. These baselines represent the relative conditions when there are no forces on the load cells and transducers. The electrical signals values may shift before or during a sounding due to thermal effects (air, water, humidity, barometric pressures, ground temperatures, or frictional heat), as well as power interruptions or electromagnetic interference. Therefore, careful monitoring and recording of the baseline readings should be taken by the operator. This may necessitate use of a zero-offset of a particular channel accordingly.

Routine CPTu Operations

The field testing engineer or technician should maintain a log of the calibration, maintenance, and routine operation of the cone penetrometer system. Each penetrometer should have a unique identification number. The field book should list the recorded calibration values of the load cells for tip and sleeve readings, porewater transducer, inclinometer, and any other sensors or channels. The net area ratio (a_n) should be listed for the particular cone. A clean filter element should be properly saturated (preferably with glycerine) at least one day prior to the sounding. The cone ports & filter should be carefully assembled and filled with glycerine (or alternate acceptable fluid) just before the test.

Prior to (and after) each sounding, a stable set of baseline readings should be taken and recorded in the field book. The computer operation & data collection depend often on the particular commercial system that is utilized. The sounding should only commence once all channels are stable in their initial values (Reasonable ranges of initial values are often provided by the manufacturer). After the sounding is completed and the cone removed from the ground, the initial & final baselines should be compared to verify that they are similar, otherwise adjustments may be necessary to the recorded data.

The equipment should be maintained in proper condition in order to collect quality and reliable data. Thus, the field engineer or technician should inspect the penetrometer system for obvious defects, wear, and omissions prior to usage. Detailed recommendations are given in ASTM D 5778 and Lunne, et al. (1997). Briefly, these may include periodic cleaning of the penetrometer and rods, replacement of worn tips & sleeves, inspection of the electronic cables and power connections, removal of bent rods, and other maintenance issues.

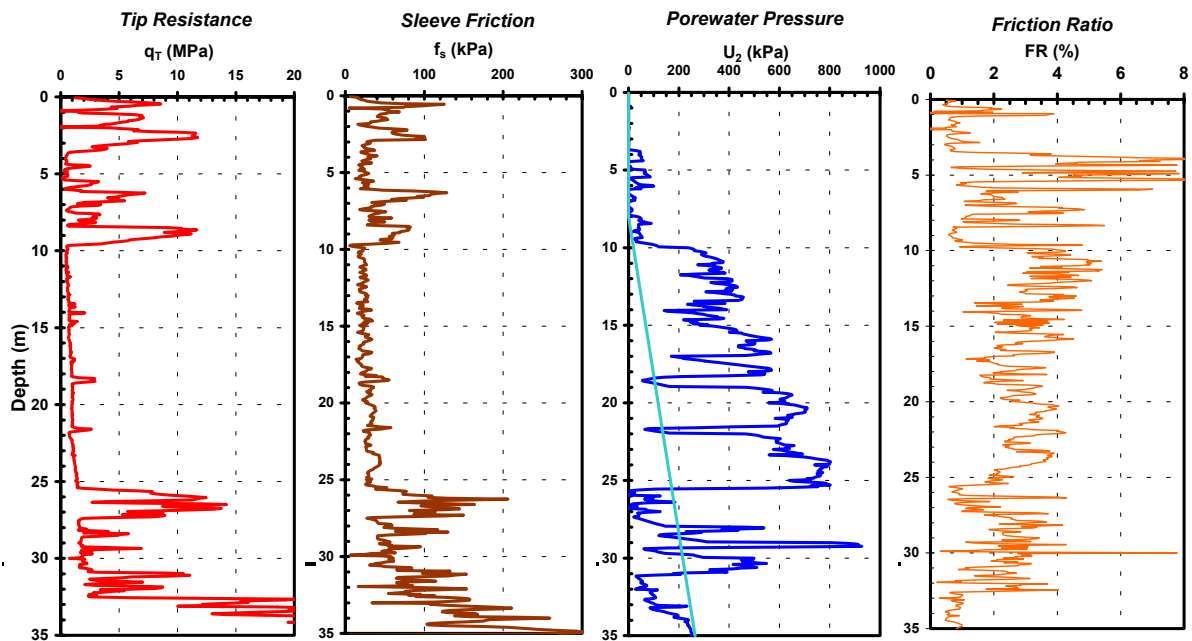

Figure 5-9. Piezocone Results next to Mississippi River, Memphis, TN.

CPT Profiles

The results of the individual channels of a piezocone penetration test are plotted with depth, as illustrated in Figure 5-8. With the continuous records and three independent channels, it is easy to discern detailed changes in strata and the inclusion of seams and lenses with the subsurface profile.

Since soil samples are not obtained with the CPT, an indirect assessment of soil behavioral type is inferred by an examination of the readings. The numbers can be processed for use in empirical chart classification systems (as given in Chapter 9), or the raw readings easily interpreted by eye for soil strata changes. For example, clean sands are generally evidenced by $q_T > 5$ MPa (50 tsf), while soft to stiff clays & silts evidence $q_T < 2$ MPa (20 tsf). Generally, penetration porewater pressures in loose sands exhibit $u_b \approx u_o$, whereas dense sands show $u_b < u_o$. In soft to stiff intact clays, penetration porewater pressures are several times hydrostatic ($u_b \gg u_o$). Notably, negative porewater pressures are observed in fissured

overconsolidated materials. The sleeve friction, often expressed in terms of a friction ratio $FR = f_s/q_T$, also is a general indicator of soil type. In sands, usually $0.5\% < FR < 1.5\%$; and in clays, normally $3\% < FR < 10\%$. A notable exception is that in sensitive and quick clays, a low FR is observed. In fact, an approximate estimate of the clay sensitivity is suggested as $10/FR$ (Robertson & Campanella, 1983).

In the above sounding (Figure 5-8), a variable interlayered sandy stratum with clay and silt lenses occurs from the ground surface to a depth of 10 meters. This is underlain by a thick layer of silty clay to depths of 25 meters, as evidenced by the low q_t and high u_b readings (well above hydrostatic), as well as the FR values from 3.5 up to 4.0%. Beneath this layer, a sandy silt layer is noted to 33 m that is underlain by dense sand within the termination depth of the sounding. Additional details and information on soil behavioral classification by CPT is given in Section 9.2.

5.3 VANE SHEAR TEST (VST)

The vane shear test (VST), or field vane (FV), is used to evaluate the in-place undrained shear strength (s_{uv}) of soft to stiff clays & silts at regular depth intervals of 1 meter (3.28 feet). The test consists of inserting a four-bladed vane into the clay and rotating the device about a vertical axis, per ASTM D 2573 guidelines. Limit equilibrium analysis is used to relate the measured peak torque to the calculated value of s_{uv} . Both the peak and remolded strengths can be measured; their ratio is termed the sensitivity, S_t . A selection of vanes is available in terms of size, shape, and configuration, depending upon the consistency and strength characteristics of the soil. The standard vane has a rectangular geometry with a blade diameter $D = 65$ mm, height $H = 130$ mm ($H/D = 2$), and blade thickness $e = 2$ mm.

The test is best performed when the vane is pushed beneath the bottom of a pre-drilled borehole. For a borehole of diameter B , the top of the vane should be pushed to a depth of insertion of at least $df = 4B$. Within 5 minutes after insertion, rotation should be made at a constant rate of $6^\circ/\text{minute}$ ($0.1^\circ/\text{s}$) with measurements of torque taken frequently. Figure 5-9 illustrates the general VST procedures. In very soft clays, a special protective housing that encases the vane is also available where no borehole is required and the vane can be installed by pushing the encasement to the desired test depth to deploy the vane. An alternative approach is to push two side-by-side soundings (one with the vane, the other with rods only). Then, the latter rod friction results are subtracted from the former to obtain the vane readings. This alternate should be discouraged as the rod friction readings are variable, depend upon inclination and verticality of the rods, number of rotations, and thus produce unreliable and questionable data.

ADVANTAGES of VST

- Assessment of undrained strength, s_{uv}
- Simple test and equipment
- Measure in-situ clay sensitivity (S_t)
- Long history of use in practice

DISADVANTAGES of VST

- Limited application to soft to stiff clays
- Slow and time-consuming
- Raw s_{uv} needs (empirical) correction
- Can be affected by sand lenses and seams

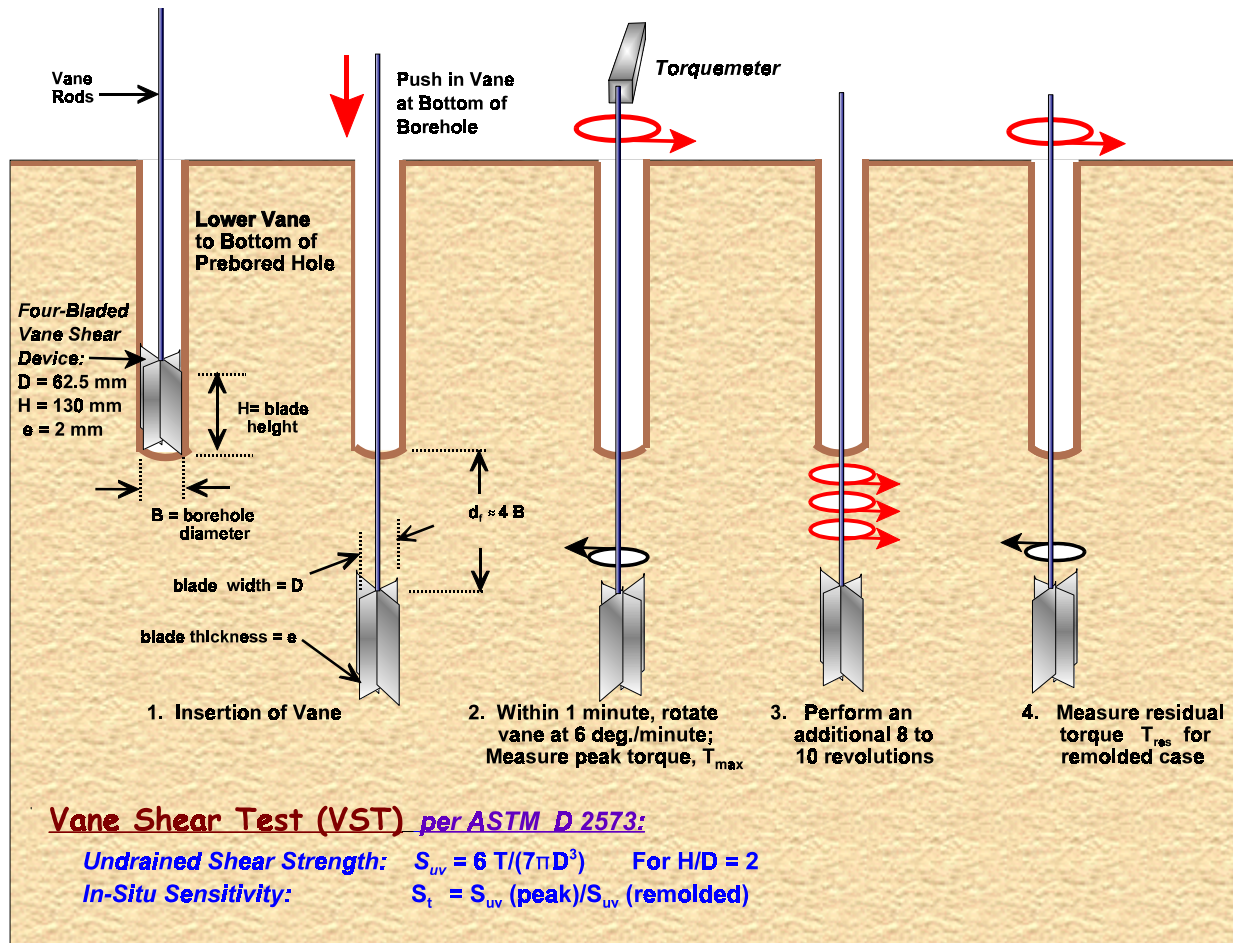

Figure 5-10. General Test Procedures for the Field Vane in Fine-Grained Soils. (Note: Interpretation of undrained strength shown is specifically for standard rectangular vane with $H/D = 2$).

Undrained Strength and Sensitivity

The conventional interpretation for obtaining the undrained shear strength from the recorded maximum torque (T) assumes a uniform distribution of shear stresses both top and bottom along the blades and a vane with height-to-width ratio $H/D = 2$ (Chandler, 1988):

$$s_{uv} = \frac{6T_{\max}}{7\pi D^3} \quad (5-3)$$

regardless of units so long as torque T and width D are in consistent units (e.g., kN-m and meters, respectively, to provide vane strength s_{uv} in kN/m²). The test is normally reserved for soft to stiff materials with $s_{uv} < 200 \text{ kPa}$. (2 tsf). After the peak s_{uv} is obtained, the vane is rotated quickly through 10 complete revolutions and the remolded (or "residual") value is recorded. The in-situ sensitivity of the soil is defined by:

$$S_t = s_u(\text{peak}) / s_u(\text{remolded}) \quad (5-4)$$

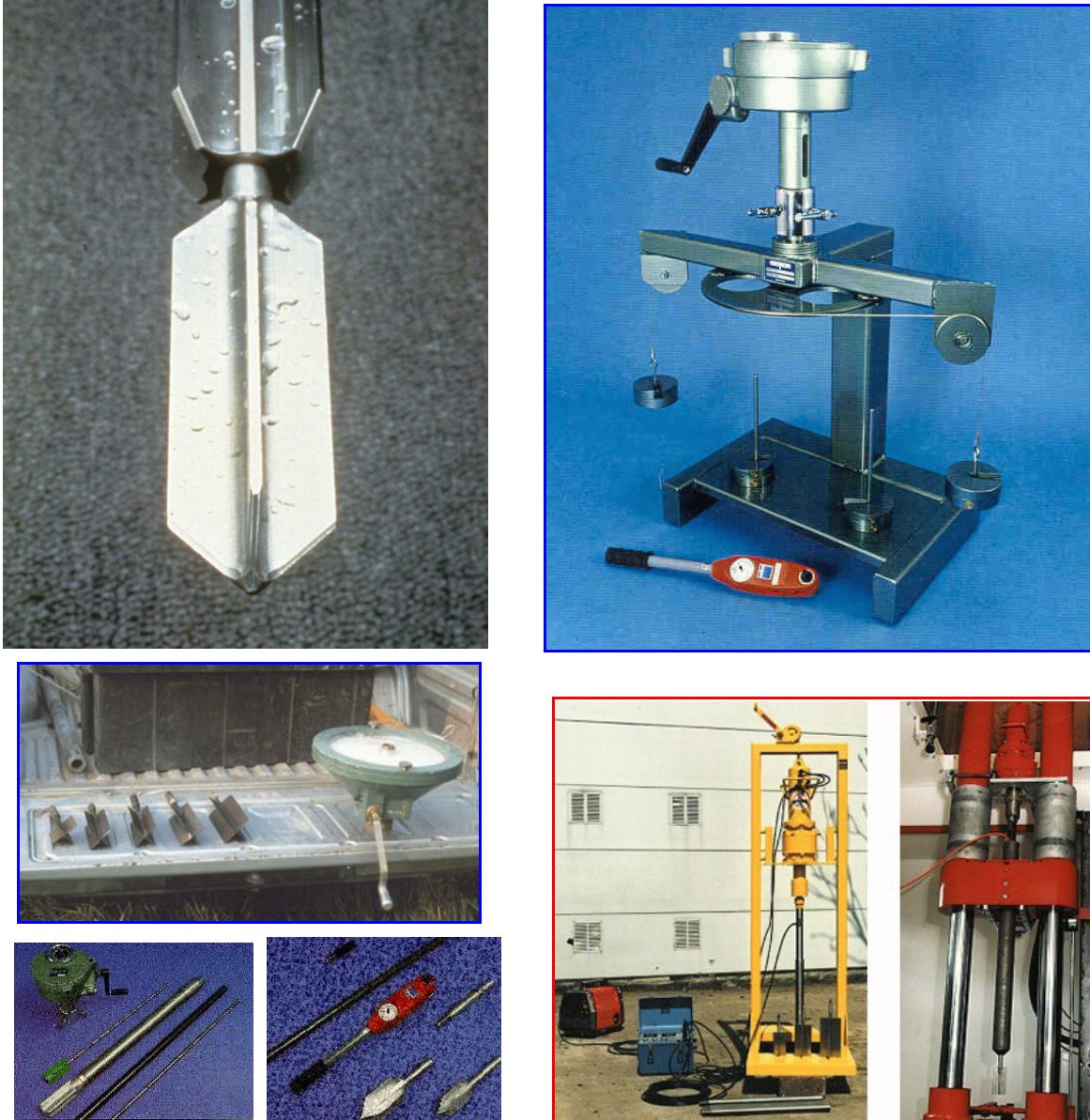

Figure 5-11. Selection of Vane Shear Blades, Pushing Frames, and Torquemeter Devices.

The general expression for all types of vanes including standard rectangular (Chandler, 1988), both ends tapered (Geonor in Norway), bottom taper only (Nilcon in Sweden), as well as rhomboidal shaped vanes for any end angles is given by:

$$s_{uv} = \frac{12T}{\pi D^2 \left[\left(\frac{D}{\cos i_T} \right) + \left(\frac{D}{\cos i_B} \right) + 6H \right]} \quad (5-5)$$

where i_T = angle of taper at top (with respect to horizontal) and i_B = angle of bottom taper, as defined in Figure 5-11.

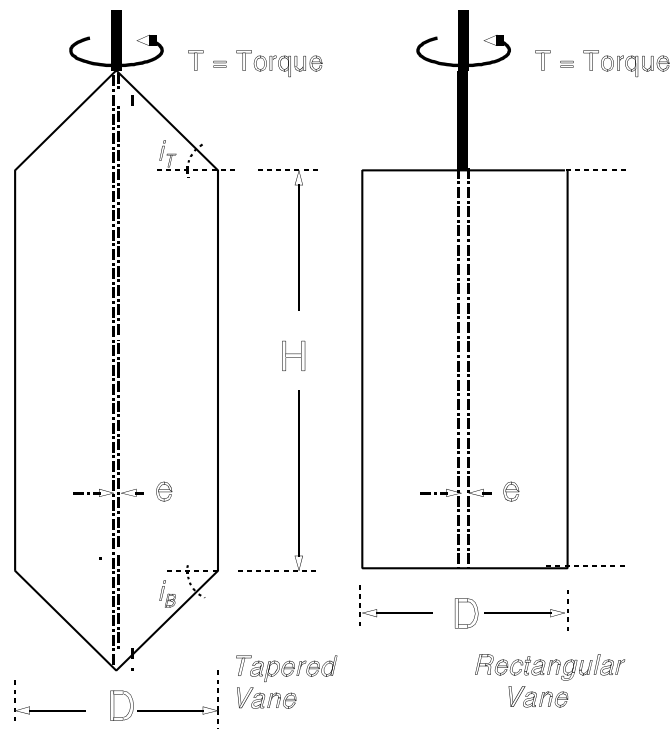

Figure 5-12. Definitions of Vane Geometries for Tapered & Rectangular Blades.

For the commercial vanes in common use, equation (5-5) reduces to the following expressions for vanes with blade heights that are twice their widths ($H/D = 2$):

$$\text{Rectangular } (i_T = 0^\circ \text{ and } i_B = 0^\circ): \quad s_{uv} = 0.273 T_{\max}/D^3 \quad (5-5a)$$

$$\text{Nilcon } (i_T = 0^\circ \text{ and } i_B = 45^\circ): \quad s_{uv} = 0.265 T_{\max}/D^3 \quad (5-5b)$$

$$\text{Geonor } (i_T = 45^\circ \text{ and } i_B = 45^\circ): \quad s_{uv} = 0.257 T_{\max}/D^3 \quad (5-5c)$$

Note that equation (5-5a) is identical to (5-3) for the rectangular vane.

Vane Results

A representative set of shear strength profiles in San Francisco Bay Mud derived from vane shear tests for the MUNI Metro Station Project are shown in Figure 5-12a. Peak strengths increase from $s_{uv} = 20$ kPa to 60 kPa with depth. The derived profile of sensitivity (ratio of peak to remolded strengths) is presented in Figure 5-12b and indicates $3 < S_t < 4$.

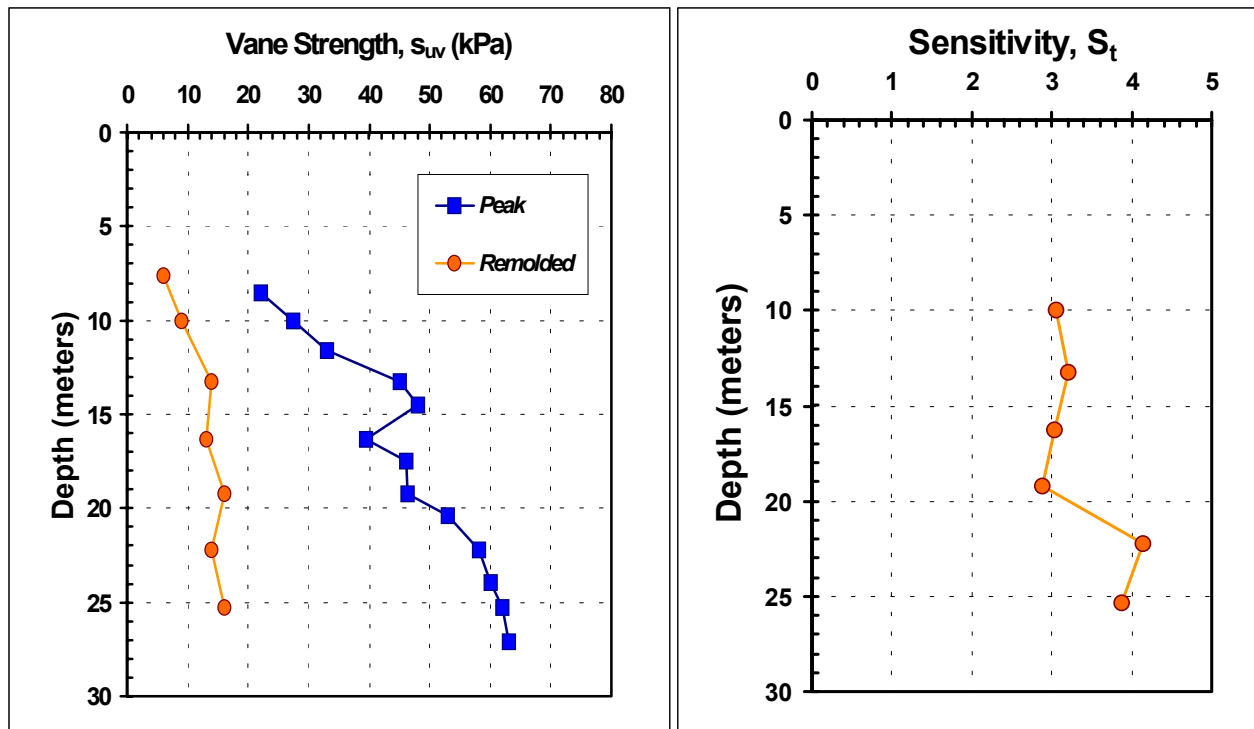

Figure 5-13. Illustrative Results from VSTs Conducted in San Francisco Bay Mud showing Profiles of (a) Peak and Remolded Vane Strengths, and (b) derived Clay Sensitivity.

Vane Correction Factor

It is very important that the measured vane strength be corrected prior to use in stability analyses involving embankments on soft ground, bearing capacity, and excavations in soft clays. The mobilized shear strength is given by:

$$J_{\text{mobilized}} = \alpha_R s_{uv} \quad (5-6)$$

where α_R = empirical correction factor that has been related to plasticity index (PI) and/or liquid limit (LL) based on backcalculation from failure case history records of full-scale projects. An extensive review of the factors and relationships affecting vane measurements in clays and silts with $PI > 5\%$ recommends the following expression (Chandler, 1988):

$$\alpha_R = 1.05 - b (PI)^{0.5} \quad (5-7)$$

where the parameter b is a rate factor that depends upon the time-to-failure (t_f in minutes) and given by:

$$b = 0.015 + 0.0075 \log t_f \quad (5-8)$$

The combined relationships are shown in Figure 5.13. For guidance, embankments on soft ground are normally associated with t_f on the order of 10^4 minutes because of the time involved in construction using large equipment.

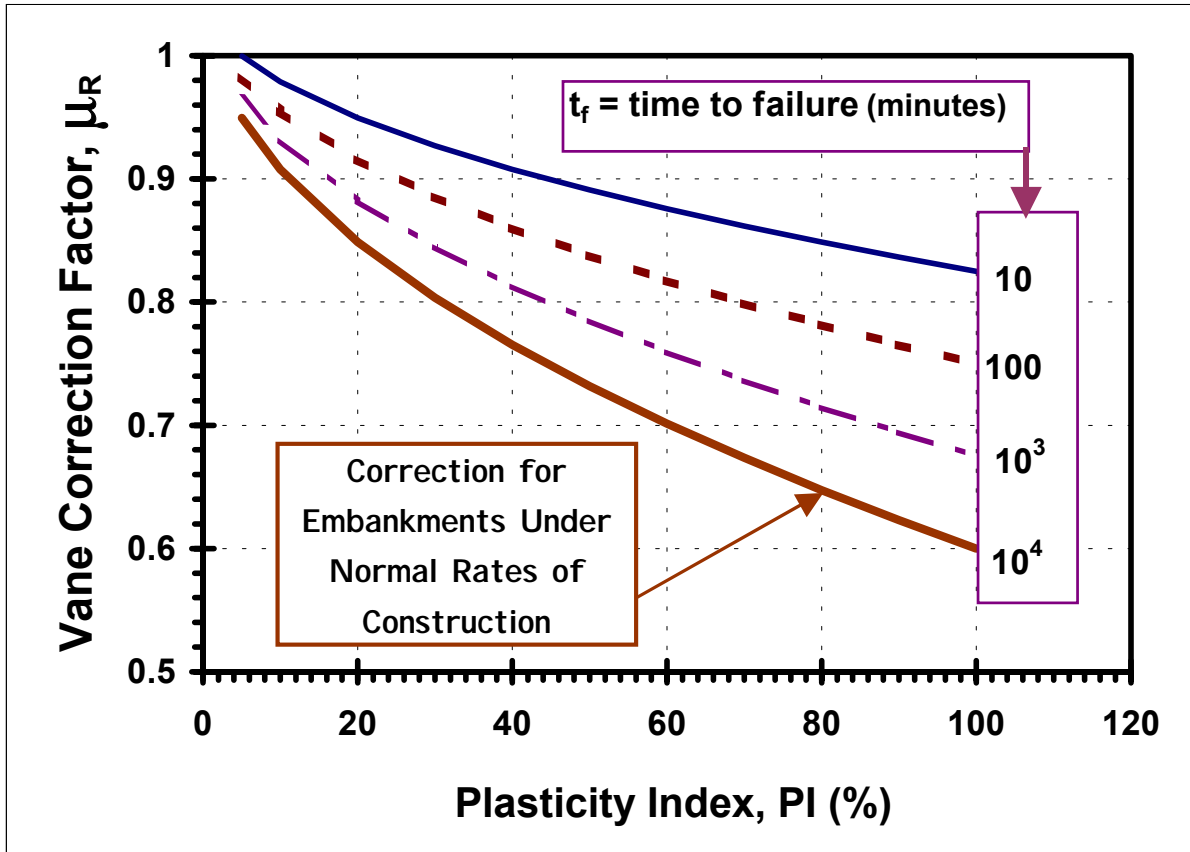

Figure 5-14. Vane Correction Factor (μ_R) Expressed in Terms of Plasticity Index and Time to Failure. (Adapted from Chandler, 1988). Note: For stability analyses involving normal rates of embankment construction, the correction factor is taken at the curve corresponding to $t_f = 10,000$ minutes.

A common means of comparing vane measurements in different clays and silts is via the normalized undrained shear strength to effective overburden stress ratio ($s_{uv}/F_{vo}r$), formerly termed the c/p ratio in older textbooks. Interestingly, the ($s_{uv}/F_{vo}r$) for normally-consolidated clays obtained from raw vane strength measurements has long been observed to increase with plasticity index (e.g., Kulhawy & Mayne, 1990). A common expression cited is: $(s_{uv}/F_{vo}r)_{uncorrected} = 0.11 + 0.0037 PI$, where PI = clay plasticity index. Yet, the vane correction factor (μ_R) decreases with PI , as shown by Figure 5-13. The net effect is that the mobilized undrained shear strength backcalculated from failure case histories involving embankments, foundations, and excavations in soft clays is essentially independent of plasticity index (Terzaghi, et al. 1996). For further information, a detailed review of the device, the procedures, and methods of interpretation for the VST are given by Chandler (1988).

5.4 FLAT PLATE DILATOMETER TEST (DMT)

The flat dilatometer test (DMT) uses pressure readings from an inserted plate to obtain stratigraphy and estimates of at-rest lateral stresses, elastic modulus, and shear strength of sands, silts, and clays. The device consists of a tapered stainless steel blade with 18° wedge tip that is pushed vertically into the ground at 200 mm depth intervals (or alternative 300-mm intervals) at a rate of 20 mm/s. The blade (approximately 240 mm long, 95 mm wide, and 15 mm thick) is connected to a readout pressure gauge at the ground surface via a special wire-tubing through drill rods or cone rods. A 60-mm diameter flexible steel membrane located on one side of the blade is inflated pneumatically to give two pressures: “A-reading” that is a lift-off or contact pressure where the membrane becomes flush with the blade face ($s^* = 0$); and “B-reading” that is an expansion pressure corresponding to $s^* = 1.1$ mm outward deflection at center of membrane. A tiny spring-loaded pin at the membrane center detects the movement and relays to a buzzer/galvanometer at the readout gauge. Normally, nitrogen gas is used for the test because of the low moisture content, although carbon dioxide or air can also be used. Reading “A” is obtained about 15 seconds after insertion and “B” is taken within 15 to 30 seconds later. Upon reaching “B”, the membrane is quickly deflated and the blade is pushed to the next test depth. If the device cannot be pushed because of limited hydraulic pressure (such as dense sands), then it can be driven in place, but this is not normally recommended.

ADVANTAGES OF DMT

- Simple and Robust
- Repeatable & Operator-Independent
- Quick and economical

DISADVANTAGES OF DMT

- Difficult to push in dense and hard materials.
- Primarily relies on correlative relationships.
- Need calibrations for local geologies.

Procedures for the test are given by ASTM D 6635 and Schmertmann (1986) and Figure 5-14 provides an overview of the device and its operation sequence. Two calibrations are taken before the sounding to obtain corrections for the membrane stiffness in air. These corrected “A” and “B” pressures are respectively notated as p_0 and p_1 with the original calculations given by (Marchetti 1980):

$$p_0 = A +) A \quad (5-9)$$

$$p_1 = B -) B \quad (5-10)$$

where) A and) B are calibration factors for the membrane stiffness in air. The) A calibration is obtained by applying suction to the membrane and) B obtained by pressurizing the membrane in air (Note: both are recorded as positive values). In stiff soils, equations (5-9) and (5-10) will normally suffice for calculating the contact pressure p_0 and expansion pressure p_1 . However, in soft clays & silts, a more accurate correction procedure is given by (Schmertmann 1986):

$$p_0 = 1.05(A +) A - z_m - 0.05(B -) B - z_m \quad (5-11)$$

$$p_1 = B -) B - z_m \quad (5-12)$$

where z_m = pressure gage offset (i.e., zero reading of gage). Normally for a new gage, $z_m = 0$. Equations (5-11) and (5-12) are to be preferred in general over the earlier equations (5-9) and (5-10).

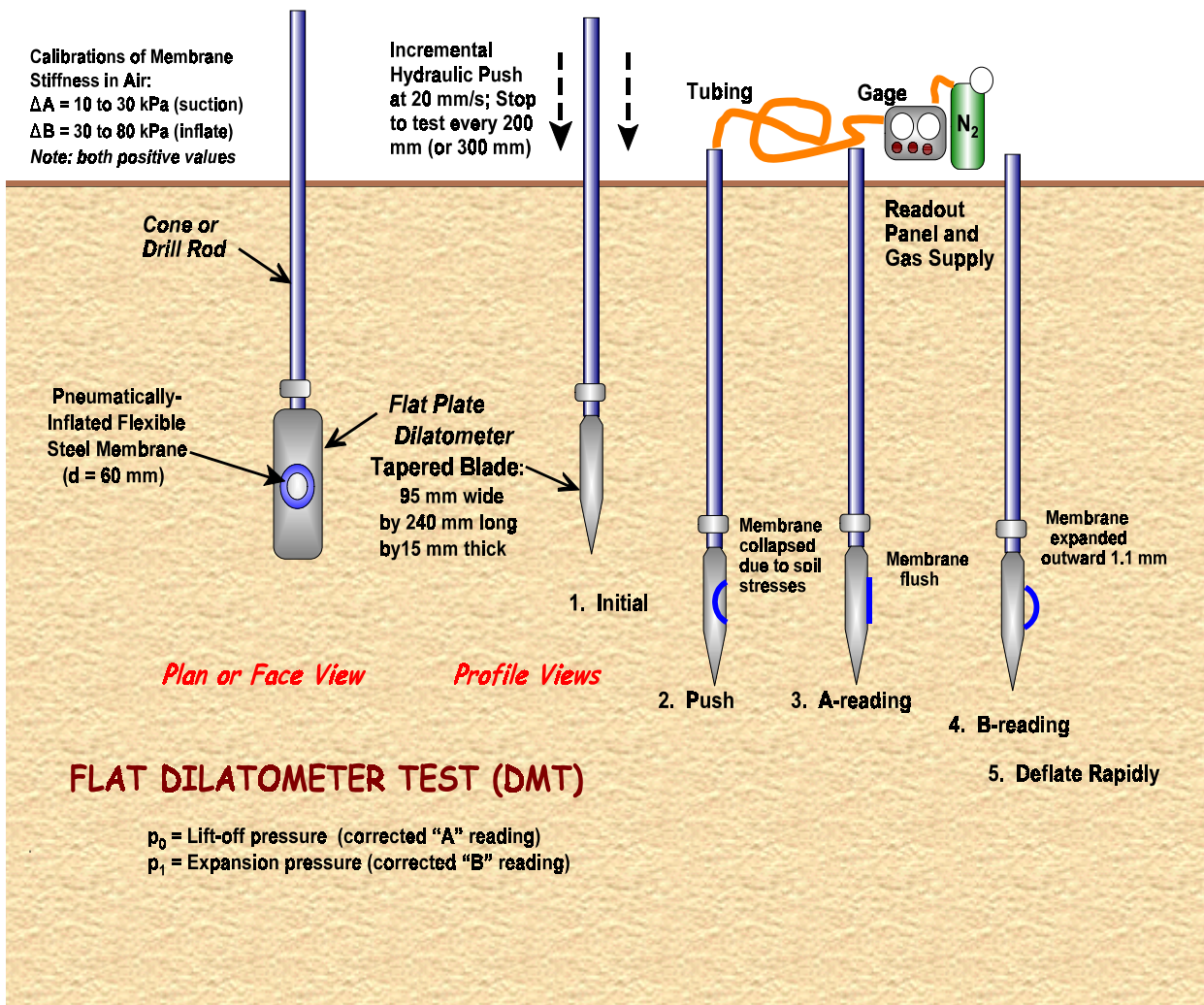

Figure 5-15. Setup and Sequence of Procedures for the Flat Plate Dilatometer Test.

The two DMT readings (p_0 and p_1) are utilized to provide three indices that can provide information on the stratigraphy, soil types, and the evaluation of soil parameters:

● *Material Index:*
$$I_D = (p_1 - p_0)/(p_0 - u_0) \quad (5-13)$$

● *Dilatometer Modulus:*
$$E_D = 34.7(p_1 - p_0) \quad (5-14)$$

● *Horizontal Stress Index:*
$$K_D = (p_0 - u_0)/F_{v0}N \quad (5-15)$$

where u_0 = hydrostatic porewater pressure and $F_{v0}N$ = effective vertical overburden stress. For soil behavioral classification, layers are interpreted as clay when $I_D < 0.6$, silts within the range of $0.6 < I_D < 1.8$, and sands when $I_D > 1.8$.



Figure 5-16. Flat Plate Dilatometer Equipment: (a) Modern Dual-Element Gauge System; (b) Early Single-Gauge Readout; (c) Computerized Data Acquisition Model.

Example results from a DMT conducted in Piedmont residual soils are presented in Figure 5-16, including the measured lift-off (p_0) and expansion (p_1) pressures, material index (I_D), dilatometer modulus (E_D), and horizontal stress index (K_D) versus depth. The soils are fine sandy clays and sandy silts derived from the in-place weathering of schistose and gneissic bedrock.

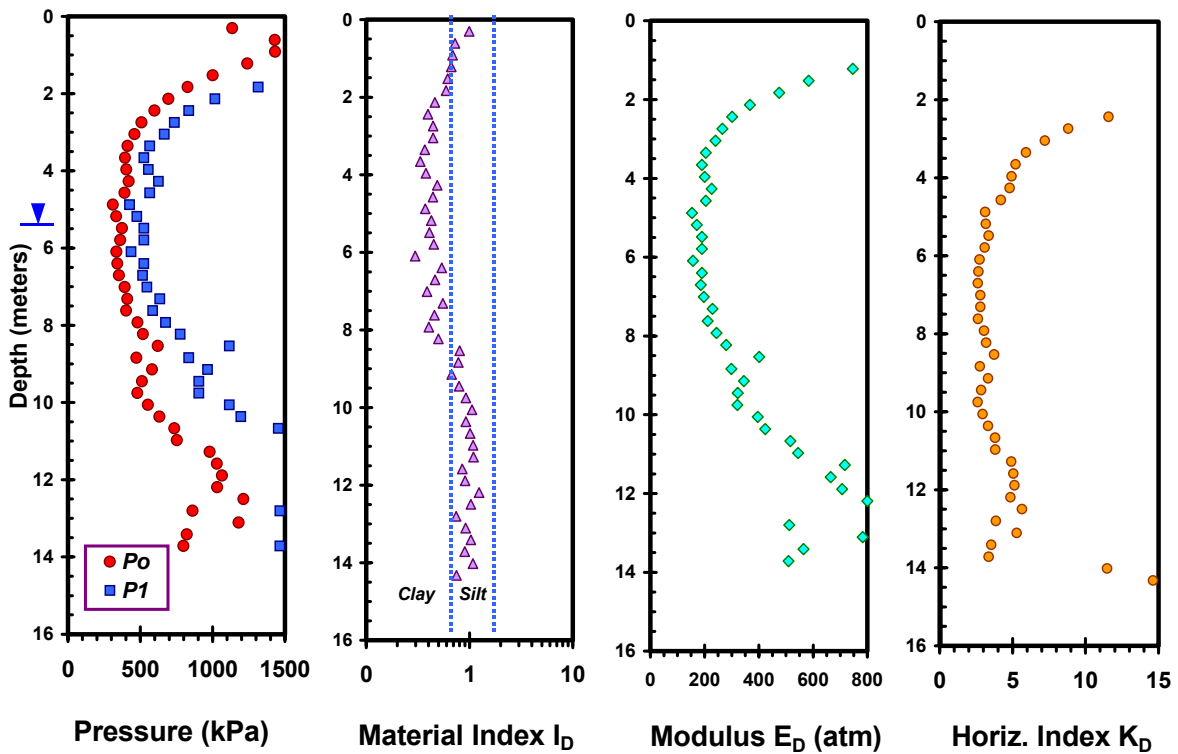

Figure 5-17. Example DMT Sounding in Piedmont residual soils (CL to ML) in Charlotte, NC.

The total soil unit weight (γ_T) can be evaluated from the material index and dilatometer modulus. For spreadsheet use, the approximate expression is:

$$\gamma_T = 1.12 \left(\gamma_w (E_D/F_{atm})^{0.1} (I_D)^{-0.05} \right) \quad (5-16)$$

where γ_w = unit weight of water and F_{atm} = atmospheric pressure. For each successive layer, the cumulative total overburden stress (F_{vo}) can be calculated, as this is needed for the determination of the effective vertical overburden stress ($F_{vo} \gamma = F_{vo} - u_o$) and the evaluation of the K_D parameter.

Modifications to the basic DMT test include: (1) a “C-reading” (or p_2) that corresponds to the A-position during deflating of the membrane; (2) the measurement of thrust force during successive test intervals; (3) dissipation readings with time; and (4) addition of a geophone to permit downhole shear wave velocity measurements. General interpretation methods for soil parameters from the DMT are given in Chapter 9.

5.5 PRESSUREMETER TEST (PMT)

The pressuremeter test consists of a long cylindrical probe that is expanded radially into the surrounding ground. By tracking the amount of volume of fluid and pressure used in inflating the probe, the data can be interpreted to give a complete stress-strain-strength curve. In soils, the fluid medium is usually water (or gas), while in weathered and fractured rocks, hydraulic oil is used.

The original “pressiometer” was introduced by the French engineer Louis Menard in 1955. This prototype had a complex arrangement of water and air tubing and plumbing with pressure gauges and valves for testing. More recently, monocell designs facilitate the simple use of pressurized water using a screw pump. Procedures and calibrations are given by ASTM D 4719 with Figure 5-17 giving a brief synopsis. Standard probes range from 35 to 73 mm in diameter with length-to-diameter ratios varying from $L/d = 4$ to 6 depending upon the manufacturer.

ADVANTAGES OF PMT

- Theoretically sound in determination of soil parameters;
- Tests larger zone of soil mass than other in-situ tests;
- Develop complete F - ϵ , σ - ϵ curve.

DISADVANTAGES OF PMT

- Complicated procedures; requires high level of expertise in the field;
- Time consuming and expensive (good day gives 6 to 8 complete tests);
- Delicate, easily damaged.

There are four basic types of pressuremeter devices:

1. *Prebored (Menard) type* pressuremeter (MPMT) is conducted in a borehole, usually after pushing and removing a thin-walled (Shelby) tube. The MPMT is depicted in Figure 5-17. The initial response reflects a recompression region as probe inflates to meet walls of boring and contact with soil.

2. *Self-boring pressuremeter* (SBP) is a probe placed at the bottom of borehole and literally eats its way into the soil to minimize disturbance and preserve the K_o state of stress in the ground. Either cutter teeth or water jetting is used to advance the probe and cuttings are transmitted through its hollow center. The probe has three internal radial arms to directly measure cavity strain, $\epsilon_c = dr/r_o$, where r_o = initial probe radius and dr = radial change. Assuming the probe expands radially as a cylinder, volumetric strain is related to cavity strain by the expansion: $(V/V_o) = 1 - (1 + \epsilon_c)^2$

3. *Push-in pressuremeter* (PIP) consists of a hollow thick walled probe having an area ratio of about 40 percent. Faster than prebored and SBP above, but disturbance effects negate any meaningful K_o measurements.

4. *Full-displacement type* (FDP): Similar to push-in type but complete displacement effects. Often incorporated with a conical point to form a cone pressuremeter (CPMT) or pressiocone.

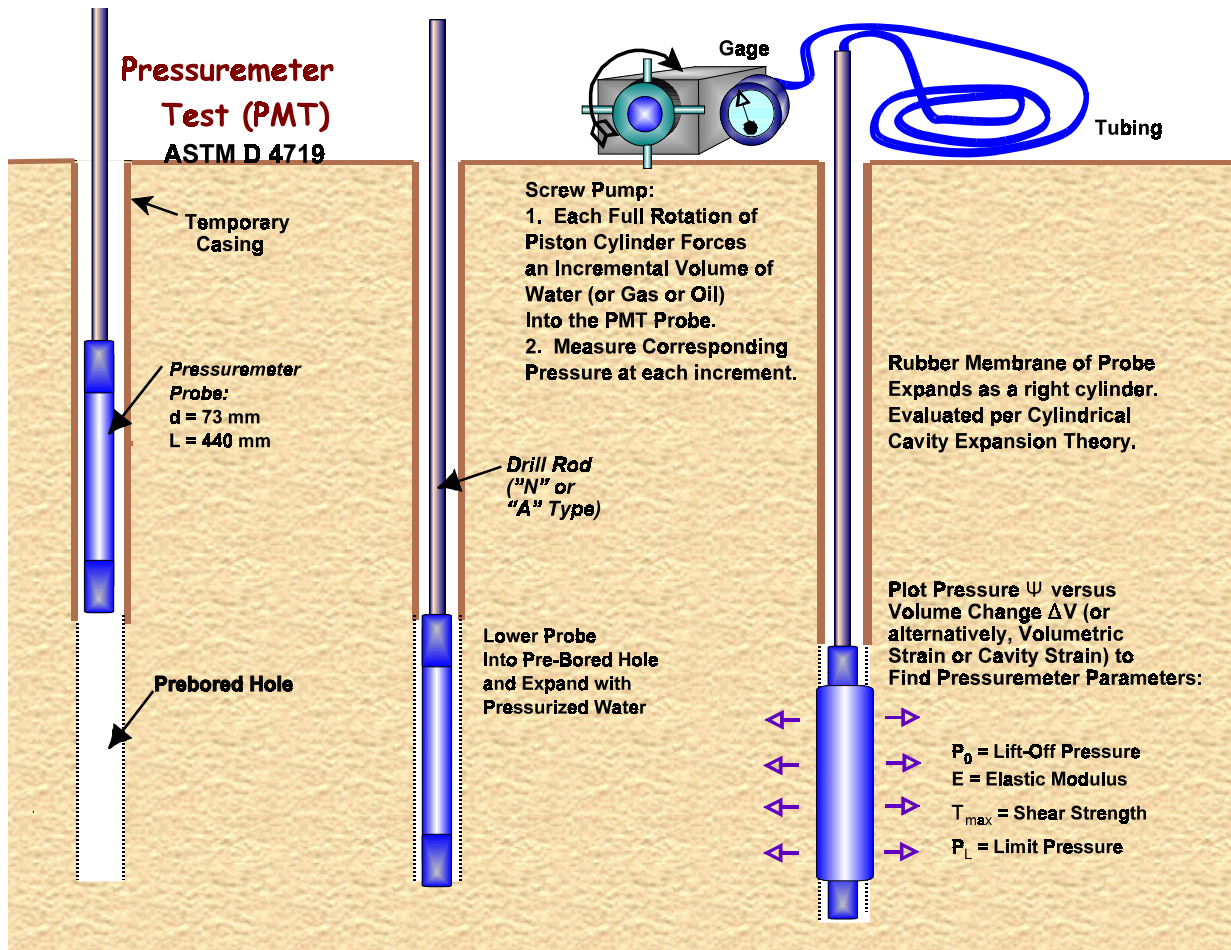

Figure 5-18. Test Procedure and Conduct of the Pre-Bored Type (Menard) Pressuremeter Test.

Procedures for the MPMT, SBP, PIP, and CPMT are similar, once the probe has been installed to the desired test depth. Often, a partial unload-reload sequence is performed during the test loading to define a pseudo-elastic response and corresponding Young's modulus (E_{ur}).

The different components of the pressuremeter equipment are shown in Figure 5-18 including: pressure gage readout panel, inflatable Menard-type probes, self-boring Cambridge probe, cutter teeth on SBP, monocell (Texam) probe, and hydraulic jack. Simple commercial systems (Texam, Oyo, and Pencil) are now available that include the a monocell probe with a displacement-type screw pump for inflation. In soil, pressurized water is used for inflating the monocell probes, whereas air pressure is often employed in computerized pressuremeter systems such as the self-boring unit and cone pressuremeter.



Figure 5-19. Photos of Pressuremeter Equipment, including Menard-type pressure panel, SBP probe, SBP cutter teeth, hydraulic jack, and monocell-type probe.

The pressuremeter provides four independent measurements with each test:

1. Lift off stress, corresponding to the total horizontal stress, $F_{ho} = P_o$;
2. An "elastic" region, interpreted in terms of an equivalent Young's modulus (E_{PMT}) during the initial loading ramp. An unload-reload cycle removes some of the disturbance effects and provides a stiffer value of E . Traditionally, the elastic modulus is calculated from:

$$E_{PMT} = 2(1+\nu) \left(\frac{V}{V_0} - 1 \right) P \quad (5-17)$$

where $V = V_0 + \Delta V$ = current volume of probe, V_0 = initial probe volume, ΔP = change in pressure in elastic region, ΔV = measured change in volume, and ν = Poisson's ratio. Alternative procedures are available to directly interpret the shear modulus (G), as given in Clark (1989).

3. A "plastic" region, corresponding to the shear strength (i.e., an undrained shear strength, s_{uPMT} for clays and silts; or an effective friction angle ϕ for sands).
4. Limit pressure, P_L (related to a measure of bearing capacity) which is an extrapolated value of pressure where the probe volume equals twice the initial volume ($V = 2V_0$). This is analogous to $\Delta V = V_0$. Several graphical methods are proposed to determine P_L from measured test data. One common extrapolation approach involves a log-log plot of pressure vs. volumetric strain ($\Delta V/V_0$) and when $\log(\Delta V/V_0) = 0$, then $P = P_L$.

Figure 5-19 shows a representative curve of pressure versus volume from a PMT in Utah. The recompression, pseudo-elastic, and plastic regions are indicated, as are the corresponding interpreted values of parameters.

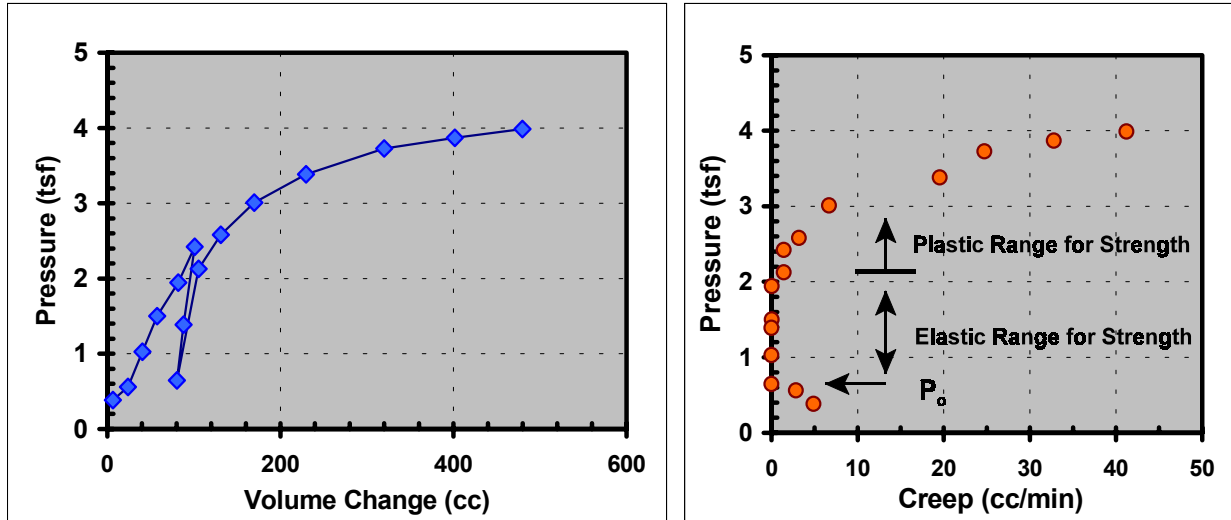

Figure 5-20. Menard-type Pressuremeter Results for Utah DOT Project.

The conduct of the test permits the direct use of cylindrical cavity expansion (CEE) theory. For the simple case of undrained loading, CCE gives:

$$P_L = P_o + s_u [\ln(G/s_u) + 1] \quad (5-18)$$

so that all four measurements are interrelated by this simple expression. Moreover, the zone of soil affected by this expansion can be related to the soil rigidity index ($I_R = G/s_u$). Here, the size of the region that is plasticized by the failure is represented by a large cylinder of radius r_p which is calculated from:

$$r_p = r_o \sqrt{I_R} \quad (5-19)$$

where r_o = initial radius of the probe. Additional details on calibration, procedures, and interpretation for the PMT are given in Baguelin, et al. (1978), Briaud (1989), and Clarke (1995).

5.6 SPECIALIZED PROBES AND IN-SITU TESTS

In addition to the common in-situ tests, there are many novel and innovative tests for special applications or needs. These are discussed elsewhere (Jamiolkowski, et al. 1985; Robertson, 1986) and include the Large Penetration Test (LPT) which is similar to the SPT, yet larger size for use in gravelly soils. The Becker Penetration Test (BPT) is essentially an instrumented steel pipe pile that is used to investigate deposits of gravels to cobbles. A number of tests attempt to directly measure the in-situ lateral stress state (i.e., K_o) including the Iowa stepped blade (ISB), push-in spade cells and total stress cells (TSC), and hydraulic fracturing method (HF) that is used extensively in rock mechanics. The borehole shear test (BST) is in essence a downhole direct shear test that applies normal stresses to platens and then measures the shearing resistance to pullout. The BST intends to determine cf and Nr in the field, although considerations of excess porewater pressures may be necessary in certain geologic formations. The plate load test (PLT) mimics a small shallow foundation while the screw plate load test (SPLT) consists of a downhole circular plate that is inserted at the bottom of a boring and loaded vertically to evaluate the stress-displacement characteristics of soil at depth.

5.7 GEOPHYSICAL METHODS

There are several kinds of geophysical tests that can be used for stratigraphic profiling and delineation of subsurface geometries. These include the measurement of mechanical waves (seismic refraction surveys, crosshole, downhole, and spectral analysis of surface wave tests), as well as electromagnetic techniques (resistivity, EM, magnetometer, and radar). Mechanical waves are additionally useful for the determination of elastic properties of subsurface media, primarily the small-strain shear modulus. Electromagnetic methods can help locate anomalous regions such as underground cavities, buried objects, and utility lines. The geophysical tests do not alter the soil conditions and therefore classify as *nondestructive*, and several are performed at the surface level (termed *non-invasive*).

ADVANTAGES OF GEOPHYSICS

- Nondestructive and/or non-invasive
- Fast and economical testing
- Theoretical basis for interpretation
- Applicable to soils and rocks

DISADVANTAGES OF GEOPHYSICS

- No samples or direct physical penetration
- Models assumed for interpretation
- Affected by cemented layers or inclusions.
- Results influenced by water, clay, & depth.

5.7.1 MECHANICAL WAVES

Geophysical mechanical wave techniques utilize the propagation of waves at their characteristic velocities for determining layering, elastic stiffnesses, and damping parameters. These tests are usually conducted at very small strain levels ($\epsilon < 10^{-3}$ percent) and thus truly contained within the elastic region of soils. There are four basic waveforms generated within a semi-infinite elastic halfspace: *compression* (or P-waves), *shear* (or S-waves), *surface* or *Rayleigh* (R-waves), and *Love* waves (L-waves). The P- and S-waves are termed body waves and the most commonly-utilized in geotechnical site characterization (Woods, 1978). The other two types are special types of hybrid compression/shear waves that occur at the free boundary of the ground surface (R) and soil layer interfaces (L). Herein, we shall discuss methods of determining the P- and S-waves.

The compression wave (V_p) is the fastest wave and moves as an expanding spherical front that emanates from the source. The amplitude of the compression wave is optimized if the source is a large impact-type (falling weight) or caused by explosive means (blasting). Magnitudes of P-waves for soils are in the typical range of 400 m/s $\#$ V_p $\#$ 2500 m/s, whereas rocks may exhibit P-waves between 2000 and 7000 m/s, depending upon the degree of weathering and fracturing. Figure 5-20 indicates representative values for different geomaterials. Since water has a compression wave velocity of about 1500 m/s, measurements of V_p for soils below the groundwater can become difficult and unreliable.

The shear wave (V_s) is the second fastest wave and expands as a cylindrical front having localized motion perpendicular to the direction of travel. Thus, one can polarize the wave as vertical (up/down) or horizontal (side to side). Since water cannot sustain shear forces, it has no shear wave and therefore does not interfere with V_s measurements in soils and rocks. S-wave velocities of soil are generally between 100 m/s $\#$ V_s $\#$ 600 m/s, although soft peats and organic clays may have lower velocities. Representative values are presented in Figure 5-21. In geomechanics, the shear wave is the most important wave-type since it relates directly to the shear modulus. Therefore, several different methods have been developed for direct measurement of V_s , as reviewed by Campanella (1994).

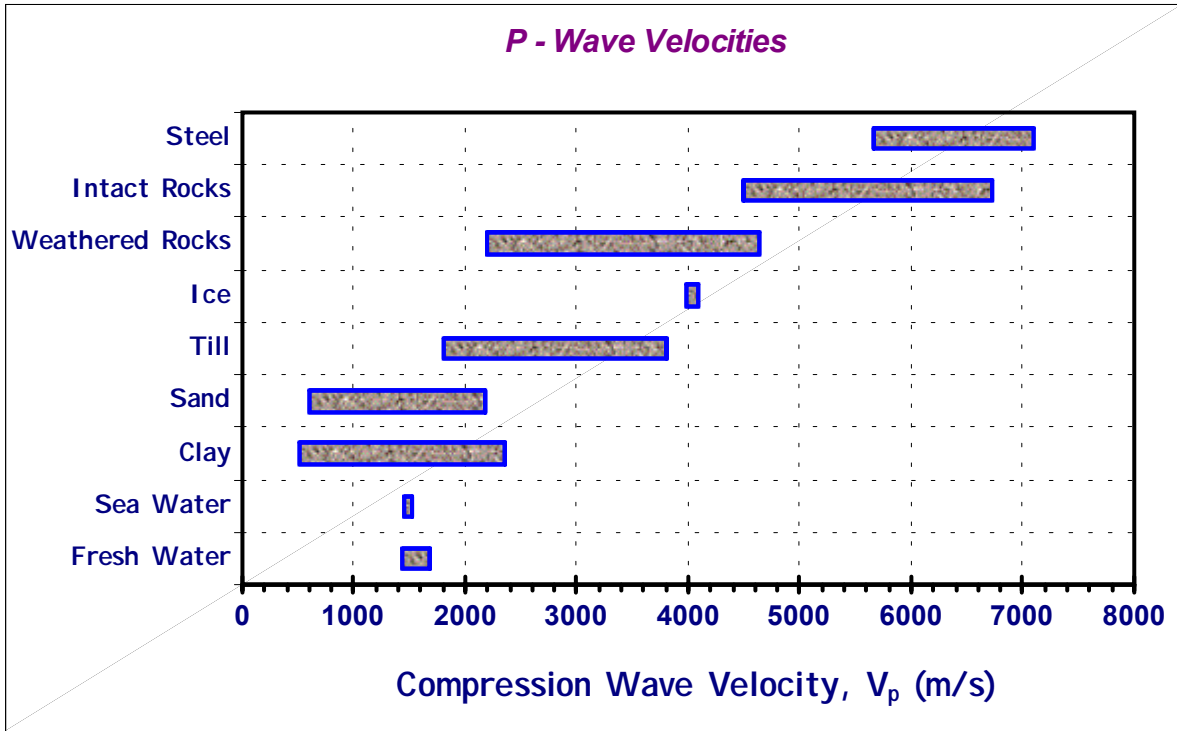

Figure 5-21. Representative Compression Wave Velocities of Various Soil and Rock Materials.

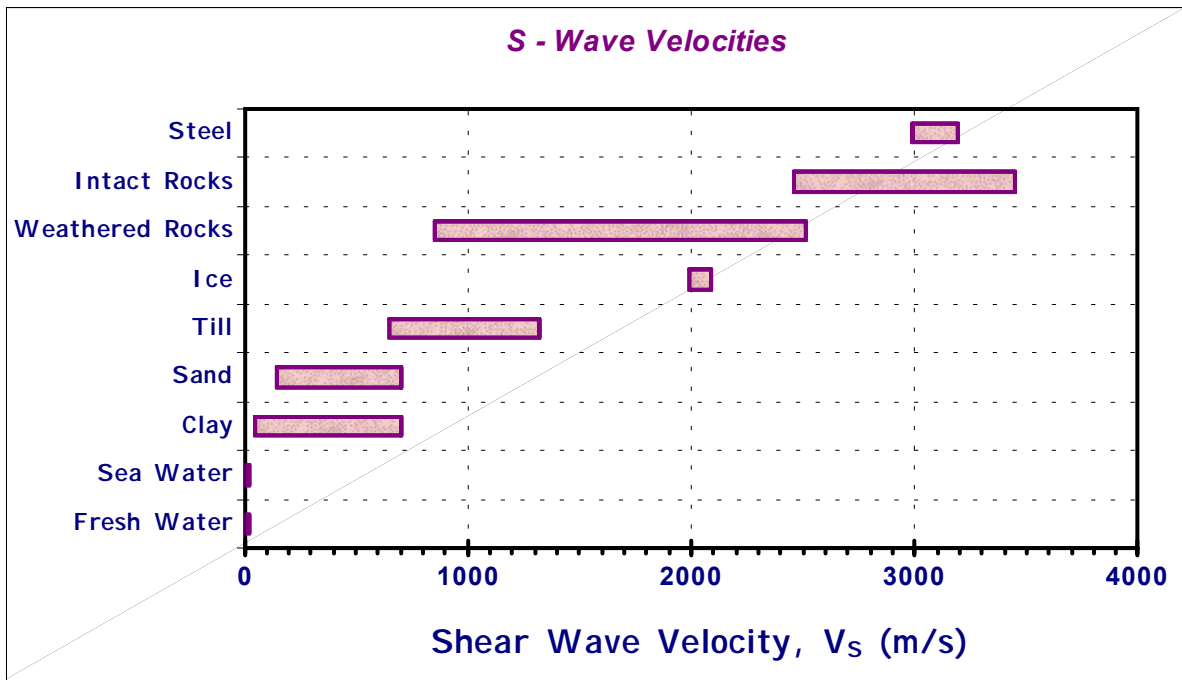

Figure 5-22. Representative Shear Wave Velocities of Various Soil and Rock Materials.

The small-strain shear modulus (G_{\max} or G_0) is evaluated from the expression:

$$G_0 = D_T V_s^2 \quad (5-20)$$

where $D_T = (\gamma_T/g =$ total mass density of the geomaterial, $(\gamma_T =$ total unit weight, and $g = 9.8 \text{ m/sec}^2 =$ gravitational acceleration constant. Note that this value of modulus applies to shear strain levels that are very small (on the order of 10^{-3} percent or less). Most foundation problems (i.e. settlements) and retaining wall situations involve strains at higher levels, on the order of 0.1 percent (Burland, 1989) and would therefore require a modulus reduction factor. In addition to static (monotonic) loading, the G_0 is useful in assessing ground motions during seismic site amplification and dynamically-loaded foundations.

5.7.2 Seismic Refraction (SR)

Seismic refraction is generally used for determining the depth to very hard layers, such as bedrock. The seismic refraction method is performed according to ASTM D 5777 procedures and involves a mapping of V_p arrivals using a linear array of geophones across the site, as illustrated in Figures 5-22 and 5-23 for a two-layer stratification. In fact, a single geophone system can be used by moving the geophone position and repeating the source event. In the SR method, the upper layer velocity must be less than the velocity of the lower layer. An impact on a metal plate serves as a source rich in P-wave energy. Initially, the P-waves travel solely through the soil to arrive at geophones located away from the source. At some critical distance from the source, the P-wave can actually travel through soil-underlying rock-soil to arrive at the geophone and make a mark on the oscilloscope. This critical distance (x_c) is used in the calculation of depth to rock. The SR data can also be useful to determine the degree of rippability of different rock materials using heavy construction equipment. Most recently, with improved electronics, the shear wave profiles may also be determined by SR.

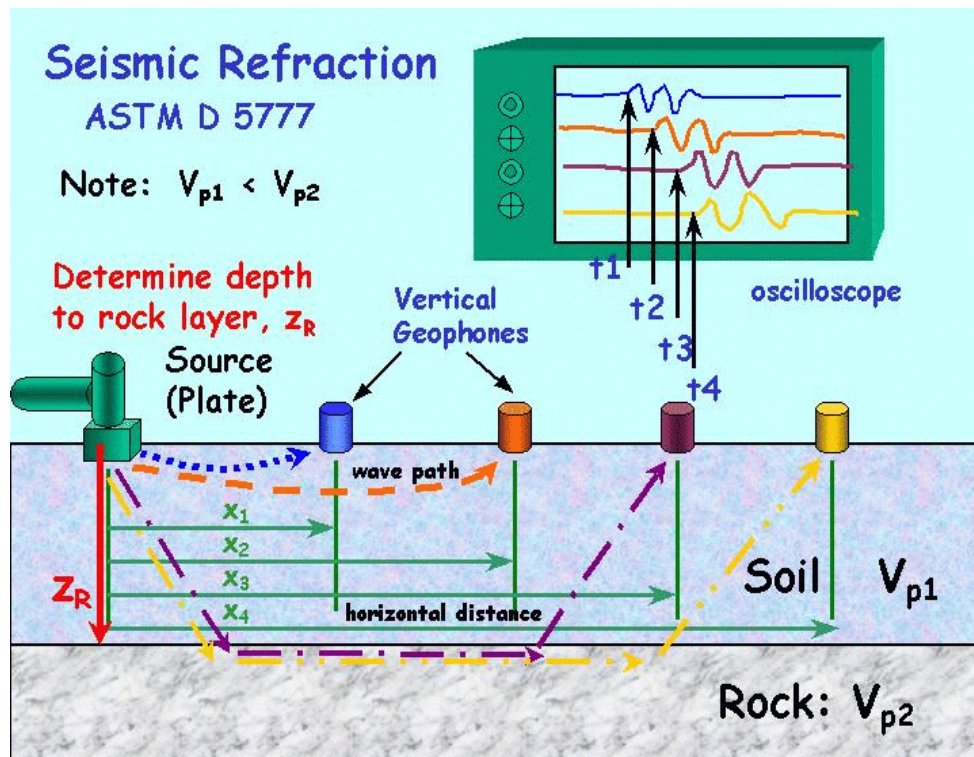

Figure 5-23. Field Setup & Procedures for Seismic Refraction Method.

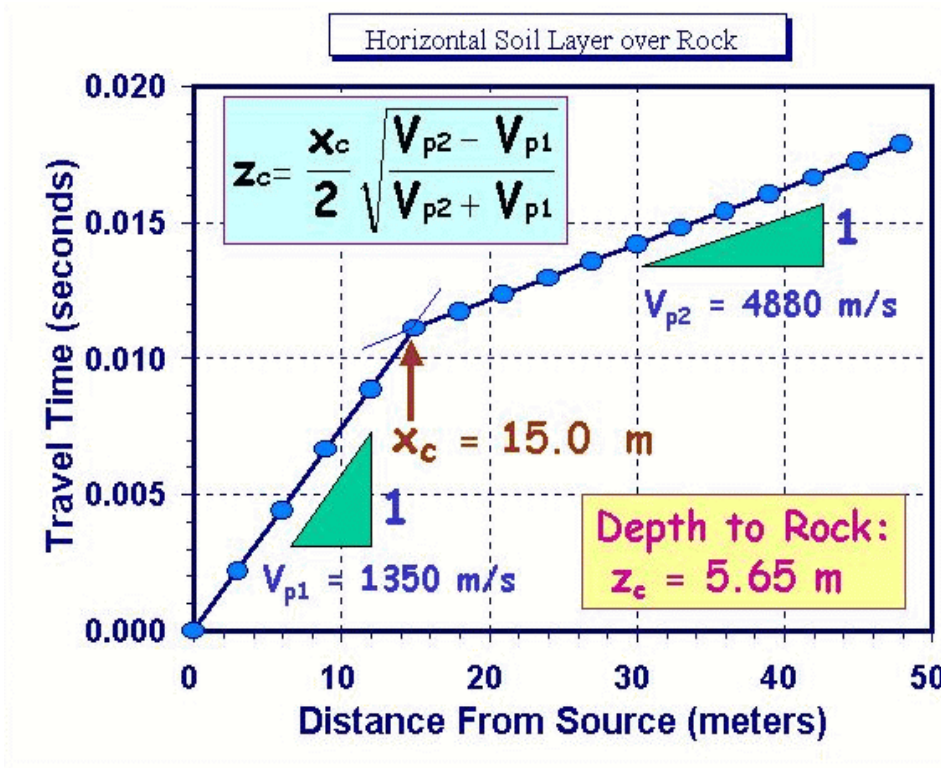

Figure 5-24. Data Reduction of SR Measurements to Determine Depth to Hard Layer.

5.7.3 Crosshole Tests (CHT)

Crosshole seismic surveys are used for determining profiles of V_p and V_s with depth per ASTM D 4428. The crosshole testing (CHT) involves the use of a downhole hammer and one or more downhole vertical geophones in an horizontal array of two or three boreholes spaced about 3 to 6 meters apart to determine the travel times of different strata (Hoar & Stokoe, 1978). A simple CHT setup using direct arrival measurements and two boreholes is depicted in Figure 5-24. The boreholes are most often cased with plastic pipe and grouted in place. After setup and curing of the grout, the borehole verticality must be checked with an inclinometer to determine changes in horizontal distances with depth, particularly if the investigations extends to depths exceeding 15 m. Special care must be exercised during testing to assure good coupling of the geophone receivers with the surrounding soil medium. Usually, inflatable packers or spring-loaded clamps are employed to couple the geophone to the sides of the plastic casing.

A special downhole hammer is preferably used to generate a vertically-polarized horizontally-propagating shear wave. An “up” strike generates a wave that is a mirror image of a “down” strike wave. The test is advantageous in that it may be conducted to great depths of up to 300 meters or more. On the other hand, there is considerable expense in pre-establishing the drilled boreholes & grouted casing, waiting for curing, inclinometer readings, and performing of the geophysical tests. A more rapid procedure is to drill the source hole to each successive test depth, insert a split spoon sampler and strike the drill rod at the surface with a trigger hammer. The disadvantage of this procedure is the absence of an “up” striking providing somewhat greater difficulty in distinguishing the initiation of each wave signal.

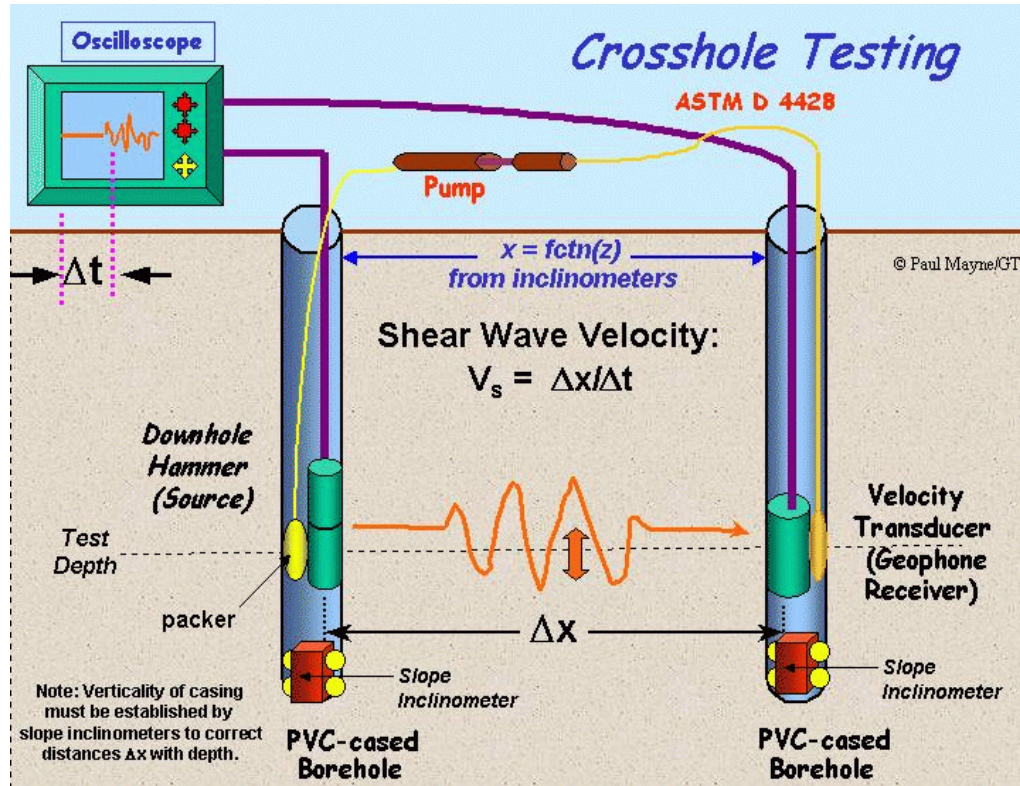

Figure 5-25. Setup and Data Reduction Procedures for Crosshole Seismic Test.

Since the P-wave arrives first, its trace is already recorded on the oscilloscope or analyzer screen. Therefore, the arrival of the S-wave is often masked because its waveform comes later. It is desirable to use a source rich in shear to increase the amplitude of the shear wave and help delineate its arrival. With reverse polarization, filtering, and signal enhancement, the S-wave signal can be easily distinguished.

5.7.4 Downhole Tests (DHT)

Downhole surveys can be performed using only one cased borehole. Here, S-waves are propagated down to the geophone from a stationary surface point. No inclinometer survey is needed as the vertical path distance (R) is calculated strongly on depth. In the DHT, a horizontal plank at the surface is statically loaded by a vehicle wheel (to increase normal stress) and struck lengthwise to provide an excellent shear wave source, as indicated in Figure 5-25. The orientation of the axis of the downhole geophone must be parallel with the horizontal plank (because shear waves are polarized and directional). The results are paired for successive events (generally at 1-m depth intervals) and the corresponding shear wave at mid-interval is calculated as $V_s = R/t$, where R = the hypotenuse distance from plank to geophone and t = arrival time of the shear wave. Added accuracy is obtained by conducting both right and left strikes for same depth and superimposing the mirrored recordings to follow the crossover (Campanella, 1994).

A recent version of the downhole method is the seismic cone penetration test (SCPT) with an accelerometer located within the penetrometer. In this manner, no borehole is needed beforehand. Figure 5-26 shows the summary of shear wave trains obtained at each 1-m intervals during downhole testing by SCPTu at Mud Island in downtown Memphis/TN.

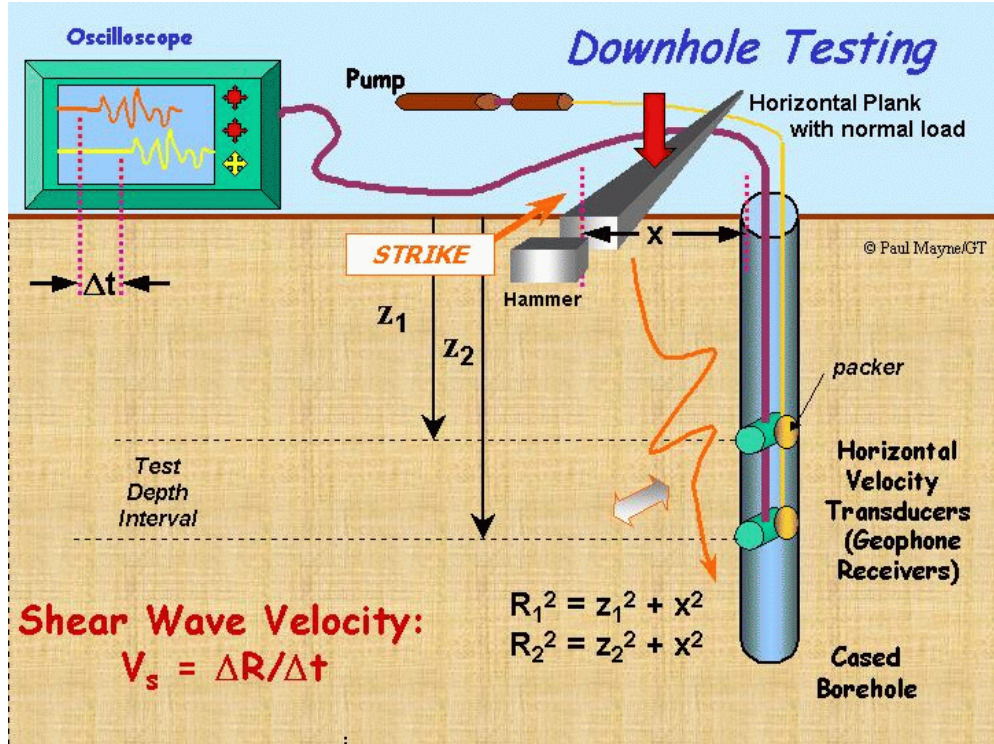

Figure 5-26. Setup and Data Reduction Procedures for Conducting a Downhole Seismic Survey.

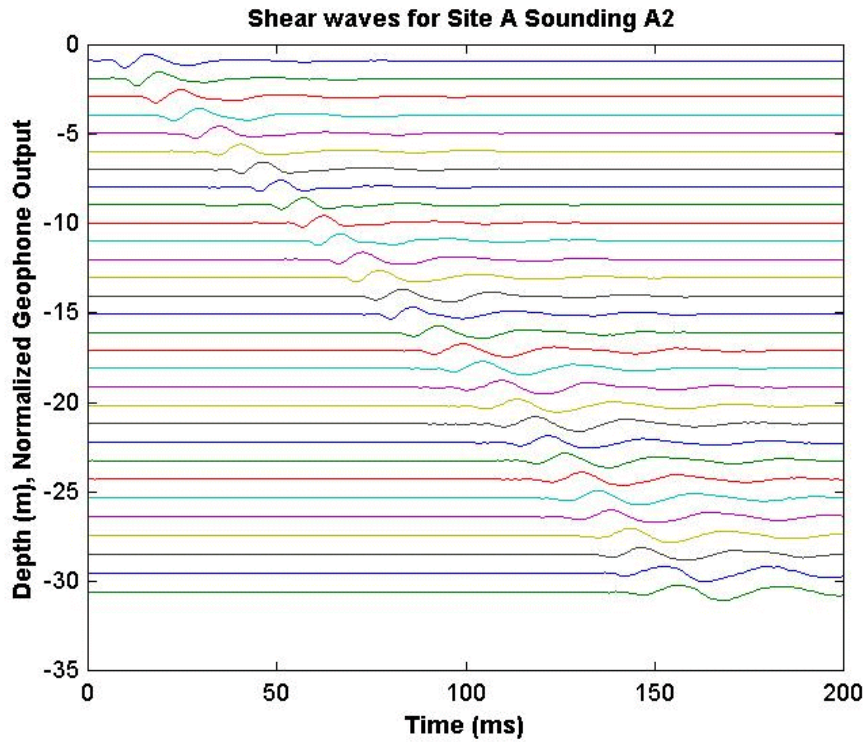

Figure 5-27. Summary Shear Wave Trains from Downhole Tests at Mud Island, Memphis, TN.

The seismic cone is a particularly versatile tool as it is a hybrid of geotechnical penetration coupled with downhole geophysical measurements (Campanella, 1994). The seismic piezocone penetration test (SCPTu) is therefore an economical and expedient means for geotechnical site characterization as it provides four independent readings with depth from a single sounding. Detailed information is obtained about the subsurface stratigraphy, soil types, and responses at complete opposite ends of the stress-strain curve. The CPT measurements are taken continuously with depth and downhole shear wave surveys are normally conducted at each rod change (generally 1-meter intervals). The penetration data (q_t , f_s , u_b) reflect failure states of stress, whereas the shear wave (V_s) provides the nondestructive response that corresponds to the small-strain stiffness. Taken together, an entire stress-strain-strength representation can be derived for all depths in the soil profile (Mayne, 2001).

Illustrative results from a SCPTu sounding in residual silts and sands of the Piedmont geology are shown in Figure 5-27. In addition to the continuous readings taken for the CPT portion, the porewater pressures were allowed to dissipate to equilibrium at each rod break. These dissipation phases provide information about the flow characteristics of the soil (namely, coefficient of consolidation and permeability), as discussed further in Chapter 6.

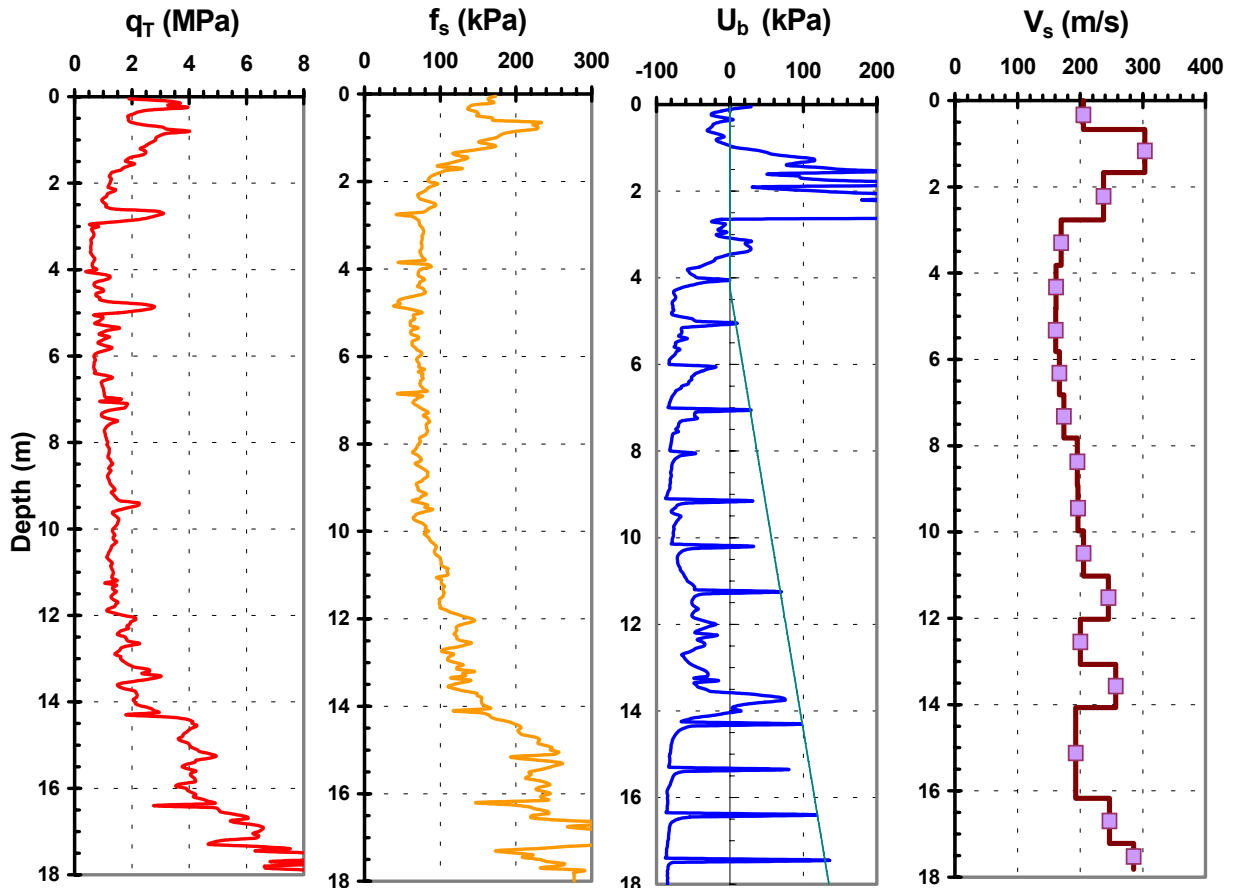

Figure 5-28. Results of Seismic Piezocone Sounding in Residual Soils in Coweta County, Georgia showing four independent readings with depth. Note: Penetration porewater pressures allowed to dissipate at each rod break.

5.7.5 Surface Waves

The *spectral analysis of surface waves* (SASW) is useful for developing profiles of shear wave velocity with depth. A pair of geophones is situated on the ground surface in linear array with a source. Either a transient force or variable vibrating mass is used to generate surface wave disturbances. The geophones are repositioned at varying distances from the source to develop a dispersion curve (see Figures 5-28 and 5-29). The SASW method utilizes the fact that surface waves (or Rayleigh waves) propagate to depths that are proportional to their wavelength. Thus, a full range of frequencies, or wavelengths, is examined to decipher the V_s profile through a complex numerical *inversion*. An advantage here is that SASW surveys require no borehole and are therefore noninvasive.

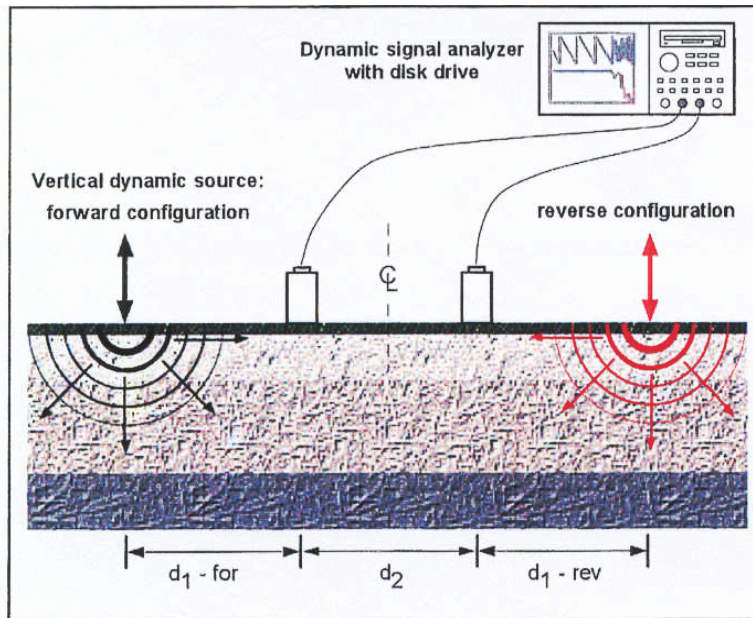

Figure 5-29. Field Setup for Conducting Spectral Analysis of Surface Waves (SASW).



Figure 5-30. Spectrum Analyzer and Data Logging Equipment for SASW.

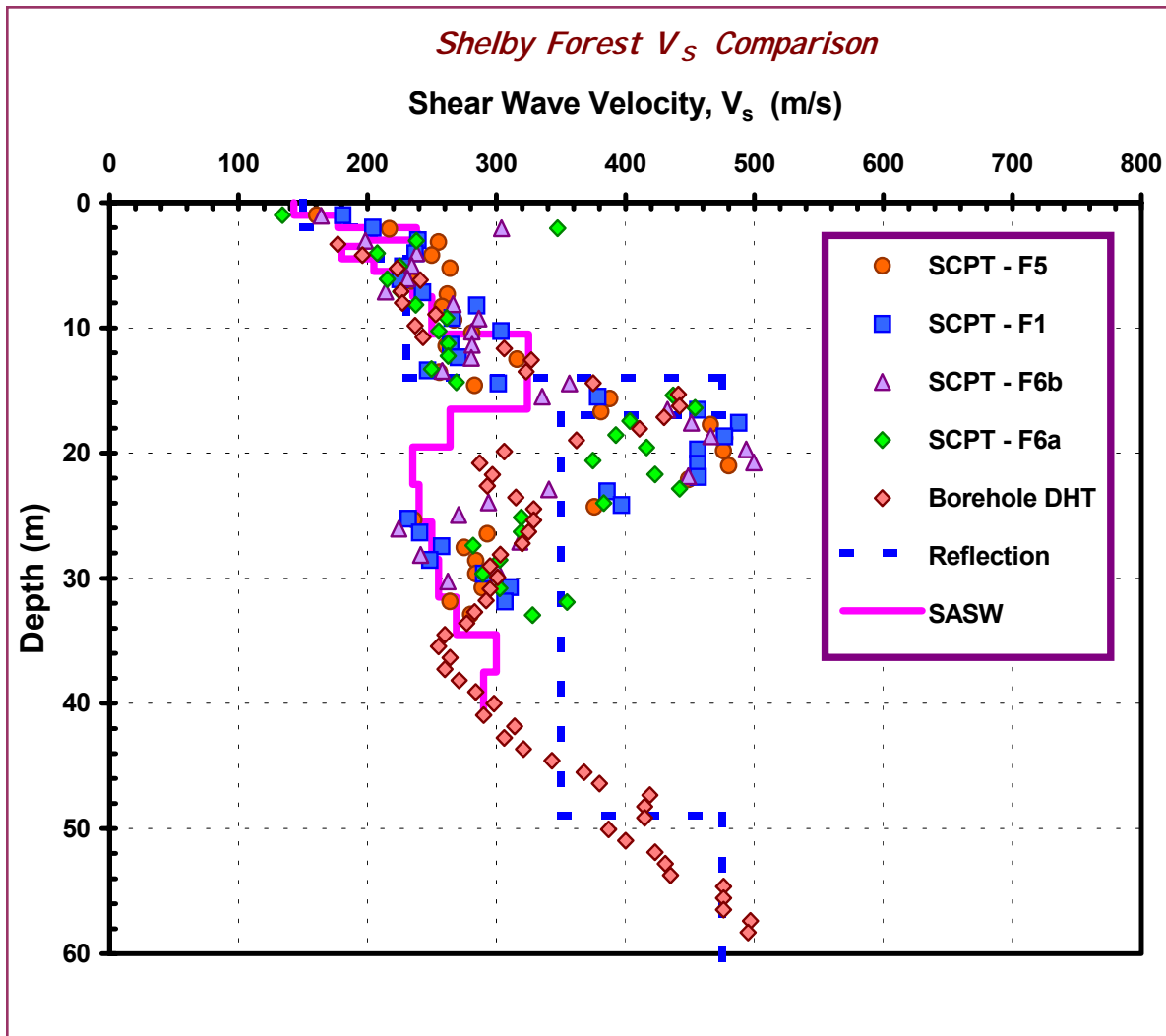

Figure 5-31. Comparison of Shear Wave Profiles from Different Geophysical Techniques.

A comparison of results of shear wave velocity measurements from different geophysical methods are presented in Figure 5-30 in aeolian and sedimentary soils at a USGS test site north of Memphis, TN. The methods include conventional downhole performed in a cased borehole (DHT), several sets of seismic piezocone soundings (SCPTu), spectral analysis of surface waves (SASW), as well as a new research method using a reflection-based evaluation. In the SASW approach, the layering profile depends on the actual penetration of the surface waves, usually assumed to be reach a depth approximately equal to one-third the wavelength and depends on the frequency components. Overall, the four methods give reasonable agreement in their V_s profiles.

In terms of practice, the downhole test (DHT) provides direct reliable measurements of V_s that are comparable to CHT results, yet at considerably less expense. For soil profiles, the DHT is facilitated by the SCPT because no site preparation of cased boreholes is needed beforehand. For S-wave profiling in weathered rocks and landfills, the SASW is advantageous, as no penetration of the medium is needed.

5.7.6 Electromagnetic Wave Methods

Electromagnetic methods include the measurement of electrical and magnetic properties of the ground, such as resistivity, conductivity (reciprocal of resistivity), magnetic fields, dielectric characteristics, and permittivity. Detailed descriptions of these properties and their measurements are provided by Santamarina, et al. (2001). The wave frequencies can be varied greatly from as low as 10 Hz to as much as 10^{22} Hz, with corresponding wavelengths ranging from 10^7 m down to 10^{-14} m. In terms of increasing frequency, the electromagnetic waveforms include: radio, microwaves, infrared, visible, ultraviolet, x-ray, and gamma rays. Surface mapping of electromagnetic waves over a gridded coverage can provide relative or absolute information about the surface conditions, as these waves penetrate the ground.

Several electromagnetic wave techniques are available commercially for noninvasive imaging and mapping of the ground. These can provide approximate locations of buried anomalies such as underground utility lines, wells, caves, sinkholes, and other features. The methods include :

- ' Ground Penetrating Radar (GPR)
- ' Electrical Resistivity Surveys (ER)
- ' Electromagnetic Conductivity (EM)
- ' Magnetometer Surveys (MS)
- ' Resistivity Piezocone (RCPTu)

With recent improvements in electronics hardware, filtering, signal processing, inversion, micro-electronics, and software, the use & interpretation of these electromechanical wave methods has become easy, fast, and economical. A brief description of these techniques is given here with illustrative examples and more detailed information can be found at the websites in Appendix B (page B-3). As the commercial equipment comes with its data-reduction software, only final results of the measurements are shown here for sake of brevity.

Ground Penetrating Radar (GPR)

Short impulses of a high-frequency electromagnetic wave are transmitted into the ground using an pair of transmitting & receiving antennae. The GPR surveys are made by gridding the site and positioning or pulling the tracking cart across the ground surface. Changes in the dielectric properties of the soil (i.e., permittivity) reflect relative changes in the subsurface environment. The EM frequency and electrical conductivity of the ground control the depth of penetration of the GPR survey. Many commercial systems come with several sets of paired antennas to allow variable depths of exploration, as well as accommodate different types of ground (Figure 5-31). A recent development (GeoRadar) uses a variably-sweeping frequency to capture data at a variety of depths and soil types.



Figure 5-32. Ground Penetrating Radar (GPR) Equipment from Xadar, GeoVision, and EKKO Sensors & Software.

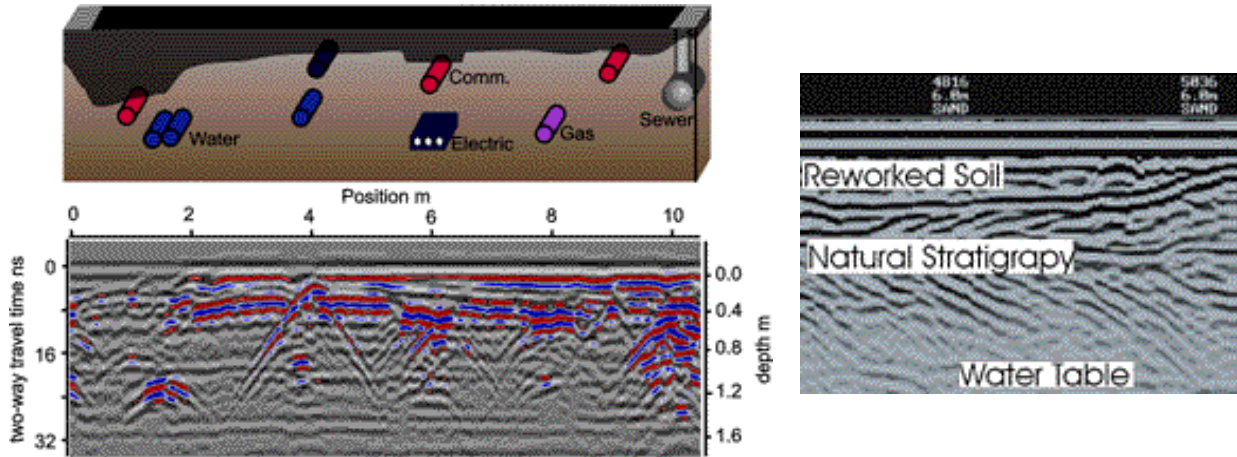

Figure 5-33. GPR Results: (a) Buried Utility Locations and (b) Soil Profile of Fill over Soil
 (from EKKO Sensors & Software: www.senssoft.on.ca)

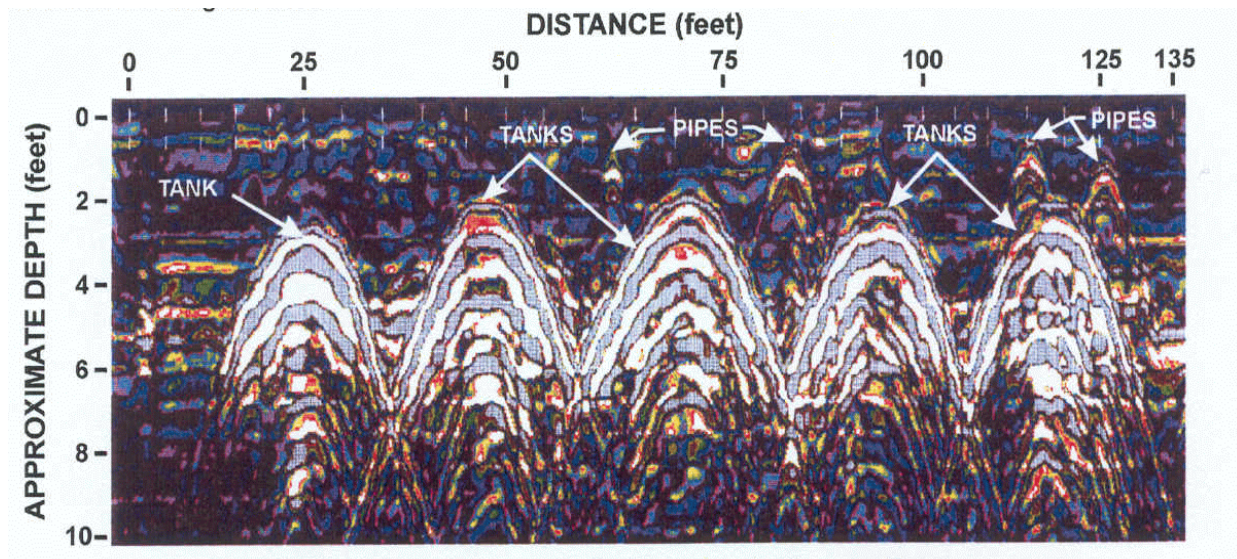

Figure 5-33 (c) GPR Locating of Underground Tanks and Pipes (GeoVision/Geometrics).

The GPR surveys provide a quick imaging of the subsurface conditions, leaving everything virtually unchanged and undisturbed. This can be a valuable tool used to define subsoil strata, underground tanks, buried pipes, cables, as well as to characterize archaeological sites before soil borings, probes, or excavation operations. It can also be utilized to map reinforcing steel in concrete decks, floors, and walls. Several illustrative examples of GPR surveys are shown in Figure 5-32. The GPR surveys are particularly successful in deposits of dry sands with depths of penetration up to 20 m or more (60 feet), whereas in wet saturated clays, GPR is limited to shallow depths of only 3 to 6 meters (10 to 20 feet).

Electrical Resistivity Survey (ER) or Surface Resistivity Method

Resistivity is a fundamental electrical property of geomaterials and can be used to evaluate soil types and variations of pore fluid and changes in subsurface media (Santamarina et al., 2001). The resistivity (D_R) is measured in ohm-meters and is the reciprocal of electrical conductivity ($k_E = 1/D_R$). Conductivity is reported in siemens per meter (S/m), where S = amps/volts. Using pairs or arrays of electrodes embedded into the surface of the ground, a surface resistivity survey can be conducted to measure the difference in electrical potential of an applied current across a site. The spacing of the electrodes governs the depth of penetration by the resistivity method and the interpretation is affected by the type of array used (Wenner, dipole-dipole, Schlumberger). The entire site is gridded and subjected to parallel arrays of SR-surveys if a complete imaging map is desired. Mapping allows for relative variations of soil types to be discerned, as well as unusual features.

In general, resistivity values increase with soil grain size. Figure 5-33 presents some illustrative values of bulk resistivity for different soil and rock types. This resistivity technique has been used to map faults, karstic features, stratigraphy, contamination plumes and buried objects, and other uses. Figure 5-34 shows the field resistivity equipment and illustrative results from an ER survey in karst to detect caves and sinkholes. Downhole resistivity surveys can also be performed using electronic probes that are lowered vertically down boreholes, or are direct-push placed. The latter can be accomplished using a resistivity module that trails a cone penetrometer, termed a resistivity piezocone (RCPTu). Downhole resistivity surveys are particularly advantageous in distinguishing the interface between upper freshwater and lower saltwater zones in coastal regions. They are also used in detecting fluid contaminants during geoenvironmental investigations.

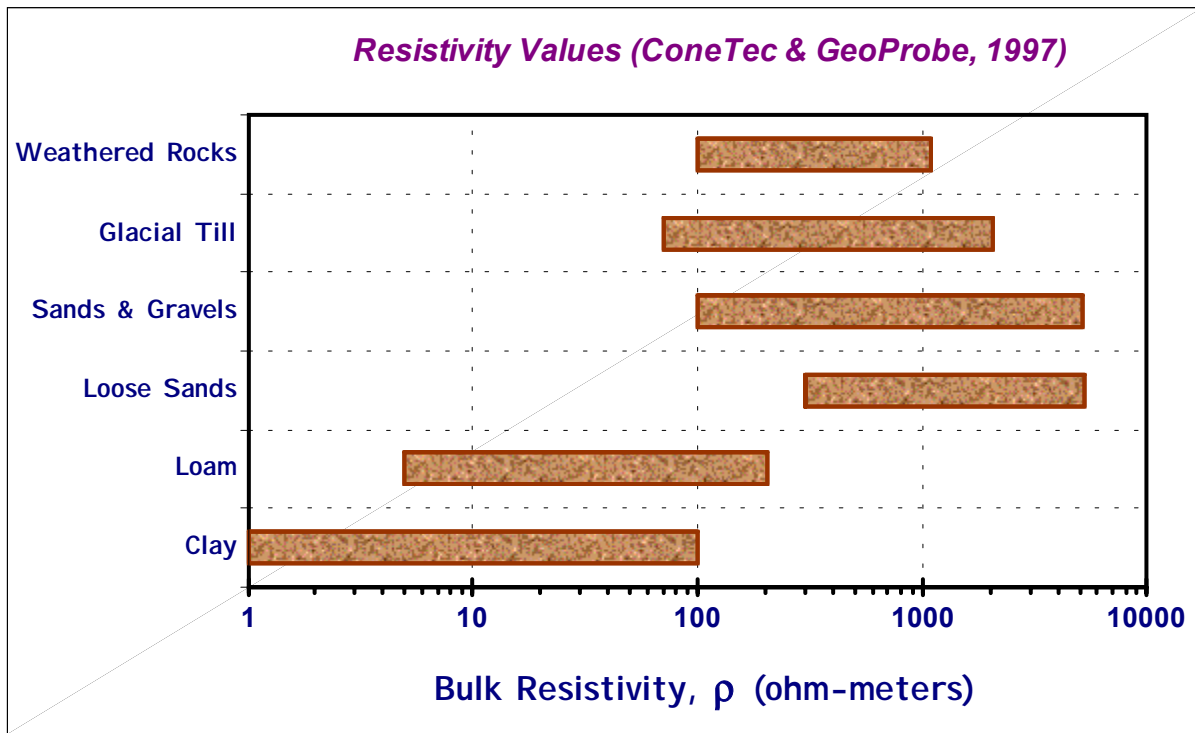
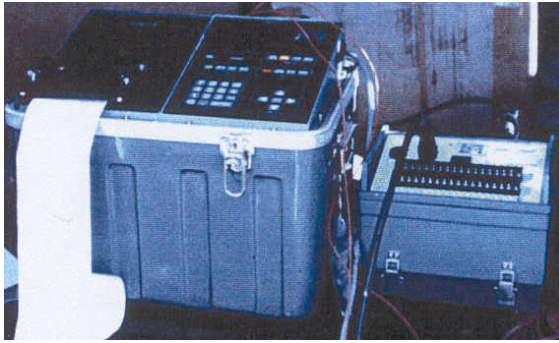
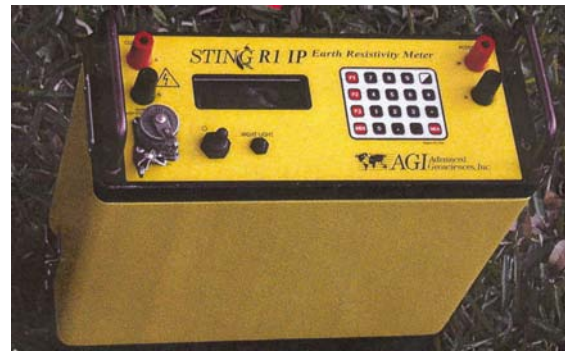

Figure 5-34. Representative Values of Resistivity for Different Geomaterials.



(a)



(b)

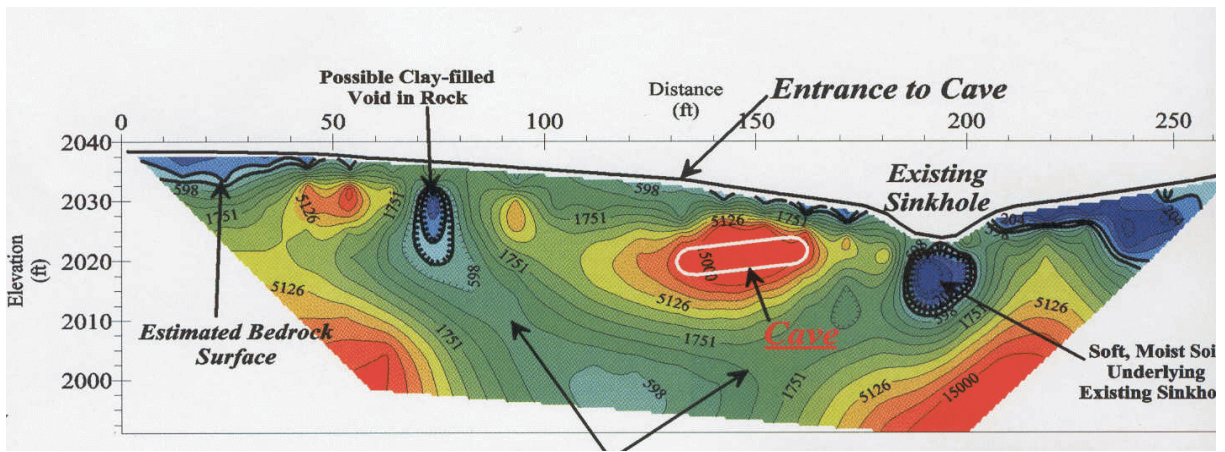

(c)

Figure 5-35. Electrical Resistivity Equipment and Results: (a) Oyo System; (b) Advanced Geosciences Inc.; (c) Two-Dimensional Cross-Section Resistivity Profile for Detection of Sinkholes and Caves in Limestone (from Schnabel Engineering Associates).

Electromagnetic Techniques

Several types of electromagnetic (EM) methods can be used to image the ground and buried features, including: induction, frequency domain, low frequency, and time domain systems. This is best handled by mapping the entire site area to show relative variations and changes. The EM methods are excellent at tracking buried metal objects and well-know in the utility locator industry. They can also be used to detect buried tanks, map geologic units, and groundwater contaminants, generally best within the upper one or two meters, yet extend to depths of 5 m or more.

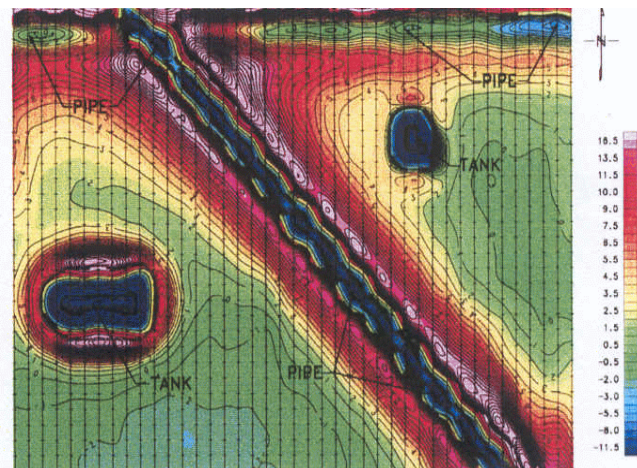

Figure 5-36. EM Survey to Detect Underground Storage Tanks (Geonics EM-31 Survey by GeoVision).

Magnetic Surveys

The earth's magnetic field, as well as local anomalies and variations within the ground, can be mapped with magnetometer equipment at the ground surface. The relative readings can be used to develop color-enhanced maps that show the changes in total magnetic field across the property. Either 2-d magnetic surveys (MS) or full areal grids can be performed to provide full coverage of buried metal objects and underground features. Figure 5-32 shows results from magnetometer surveys for locating abandoned oil wells.

Additional details on SR, EM, GPR, and MS can be found in Greenhouse, et al. (1998) and the geophysical information portion of the Geoforum website at:

<http://www.geoforum.com/info/geophysical/>

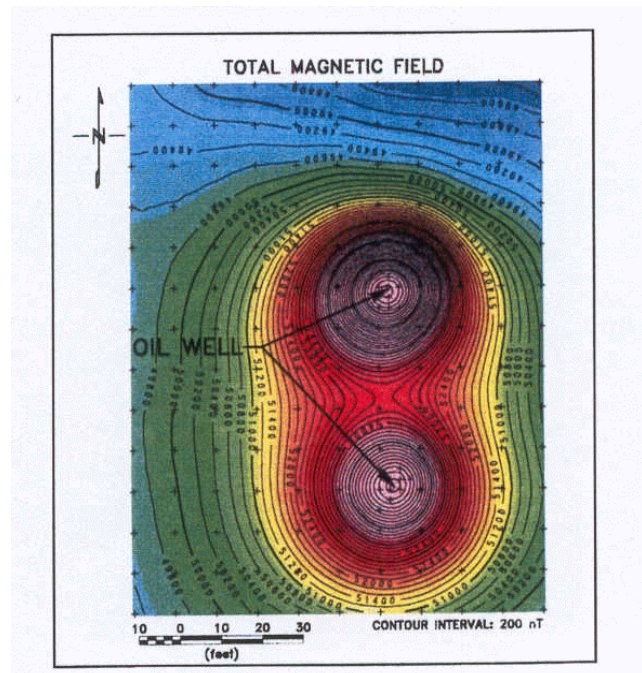

Figure 5-37. Magnetometer Survey Results (Geometrics).

5.8 SUMMARY ON IN-SITU GEOTECHNICAL & GEOPHYSICAL METHODS

In-situ physical and geophysical testing provide direct information concerning the subsurface conditions, geostatigraphy, and engineering properties prior to design, bids, and construction on the ground. The electromagnetic wave geophysics (GPR, EM, ER, MS) are non-invasive and non-destructive. By mapping the entire surface area of the site, these techniques are useful in imaging the generalized subsurface conditions and detecting utilities, hidden objects, boulders, and other anomalies. The mapping is conducted on a relative scale of measurements that reflect changes across the property. They may aid in finding underground cavities, caves, sinkholes, and erosional features in limestone and dolostone terrain. In pre-occupied land, they may be used to detect underground utility lines, buried tanks and drums, and objects of environmental concern.

Mechanical wave geophysics (CHT, DHT, SASW, SR) provide important measurements of compression (P), shear (S), and Rayleigh (R) wave velocities that determine geostrata layering and small-strain properties of soil and rock. The SR provides P-wave velocities and SASW obtains S-wave profiles and both are conducted at the surface of the ground and are therefore non-invasive as well as non-destructive. The CHT and DHT require cased boreholes, yet the seismic penetrometer (SCPT) now offers a quick and economical version of DHT for routine application. In geotechnical applications, the shear wave velocity (V_s) provides the fundamental measurement of small-strain stiffness, in terms of low-amplitude shear modulus ($G_0 = D_T V_s^2$), where D_T is the total mass density of the ground. Traditionally, the stiffness from shear wave velocity measurements has been used in site amplification analyses during seismic ground hazard studies and the evaluation of dynamically-loaded foundations supporting machinery, yet in recent findings, this stiffness has been shown of equal importance and relevance to small-strain behavior of static and monotonic loading, including deflections of pile foundations, excavations, and walls, as well as foundation settlement evaluations (Burland, 1989; Tatsuoka & Shibuya, 1992).

In soils, in-situ geotechnical tests include penetration-type (SPT, CPT, CPTu, DMT, CPMT, VST) and probing-type (PMT, SBP) methods to directly obtain the response of the geomaterials under various loading situations and drainage conditions. These tests are complementary and should be used together with geophysics to develop an understanding of the natural soil & rock formations that comprise the project site. The general applicability of the test method depends in part on the geomaterial types encountered during the site investigation, as shown by Table 5.1 below. The relevance of each test also depends on the project type and its requirements. In general, the geophysical methods can also be applied to weathered rock masses and fractured rock formations.

The evaluation of strength, deformation, flow, and time-rate behavior of soil materials can be derived from selected tests or combinations of these test methods (see Chapter 9). Together, information from these tests allow for the rational and economical selection for deciding foundation types for bridges and buildings, safe embankment construction over soft ground, cut angles for adequate slope stability, and lateral support for underground excavations. Notably, hybrids of geotechnical and geophysical devices, such as the seismic piezocone (SCPTu) and seismic dilatometer (SDMT) provide an optimization of data collection within the same sounding, as well as information at both non-destructive small-strain stiffnesses and large-strain strength regions of the material (Mayne, 2001).

TABLE 5-1.

RELEVANCE OF IN-SITU TESTS TO DIFFERENT SOIL TYPES

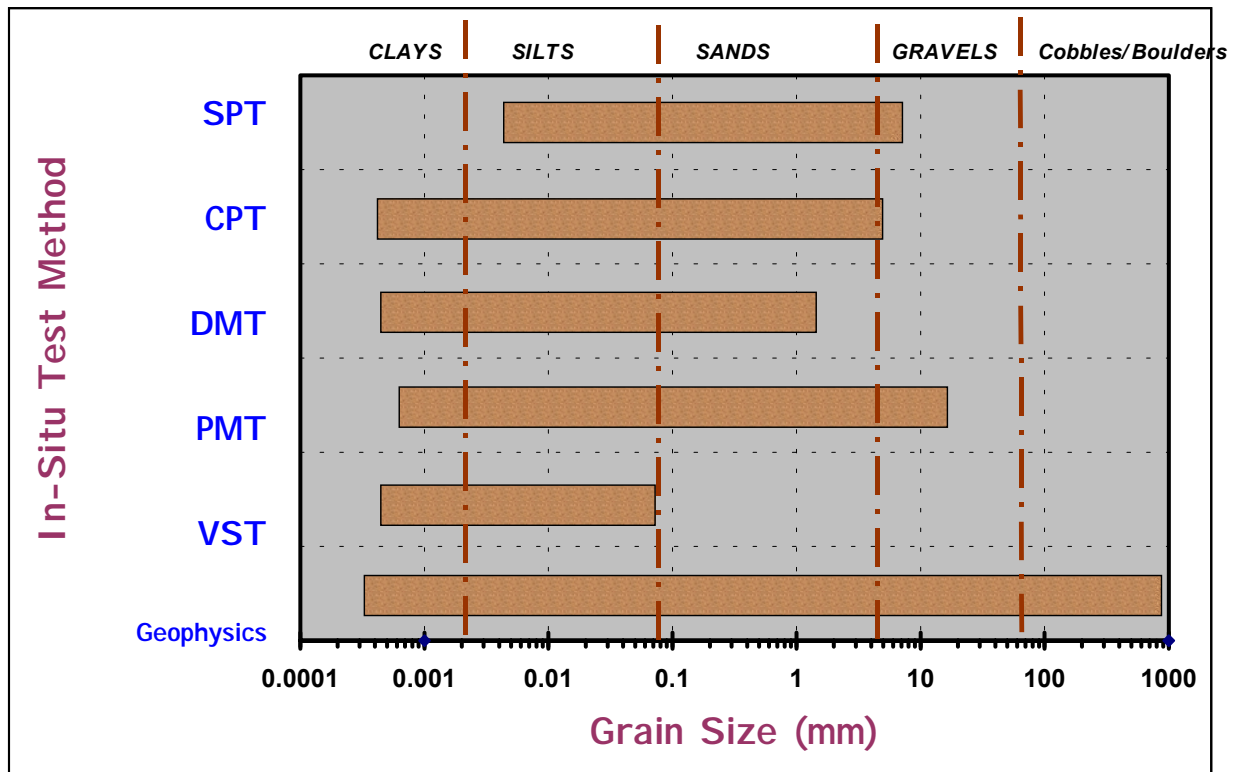

[BLANK]