



Online Continuing Education for Professional Engineers
Since 2009

Overview of Coastal Geology

PDH Credits:

15 PDH

Course No.:

COG101

Publication Source:

US Corp of Engineers

"Engineering and Design: Coastal Geology"

Pub. # EM-1110-2-1810

Release Date:

Jan. 1995

DISCLAIMER:

All course materials available on this website are not to be construed as a representation or warranty on the part of Online-PDH, or other persons and/or organizations named herein. All course literature is for reference purposes only, and should not be used as a substitute for competent, professional engineering council. Use or application of any information herein, should be done so at the discretion of a licensed professional engineer in that given field of expertise. Any person(s) making use of this information, herein, does so at their own risk and assumes any and all liabilities arising therefrom.

CECW-EG Engineer Manual 1110-2-1810	Department of the Army U.S. Army Corps of Engineers Washington, DC 20314-1000	EM 1110-2-1810 31 January 1995
	Engineering and Design COASTAL GEOLOGY	
	Distribution Restriction Statement Approved for public release; distribution is unlimited.	

**DEPARTMENT OF THE ARMY
U.S. ARMY CORPS OF ENGINEERS
Washington, DC 20314-1000**

EM 1110-2-1810

CECW-EG

Manual
No. 1110-2-1810

31 January 1995

**Engineering and Design
COASTAL GEOLOGY**

1. Purpose. This manual provides an overview of coastal geology and a discussion of data sources and field study methods applicable to coastal geological studies. This manual is intended for use by USACE engineers, geologists, and oceanographers tasked with conducting coastal geological investigations.

2. Applicability. This manual applies to all HQUSACE elements, major subordinate commands, districts, laboratories, and field operating activities having civil works responsibilities.

FOR THE COMMANDER:



R. C. JOHNS

Colonel, Corps of Engineers
Chief of Staff

CECW-EG

Manual
No. 1110-2-1810

31 January 1995

**Engineering and Design
COASTAL GEOLOGY**

Table of Contents

Subject	Paragraph	Page	Subject	Paragraph	Page
Chapter 1			Chapter 4		
Introduction			Coastal Morphodynamics		
Purpose	1-1	1-1	Introduction	4-1	4-1
Applicability	1-2	1-1	Introduction to Bed Forms	4-2	4-1
References	1-3	1-1	Deltaic Processes	4-3	4-4
Background	1-4	1-1	Inlet Processes and Dynamics	4-4	4-17
Organization of This Manual	1-5	1-2	Morphodynamics and Shoreface Processes of Clastic Sediment Shores	4-5	4-33
Proponent	1-6	1-3	Cohesive Shore Processes and Dynamics	4-6	4-55
Acknowledgment	1-7	1-4	Chapter 5		
Chapter 2			Coastal Geological Investigations		
Coastal Terminology and Geologic Environments			Introduction		
General	2-1	2-1	Sources of Existing Coastal Information	5-2	5-1
Coastal Zone Definitions and Subdivisions	2-2	2-1	Field Data Collection and Observation	5-3	5-10
Geologic Time and Definitions	2-3	2-3	Laboratory Techniques and Approaches	5-4	5-32
Water Level Datums and Definitions	2-4	2-5	Analysis and Interpretation of Coastal Data	5-5	5-40
Factors Influencing Coastal Geology	2-5	2-6	Summary	5-6	5-90
Sea Level Changes	2-6	2-20	Chapter 3		
Cultural (Man-Made) Influences on Coastal Geology	2-7	2-29	Coastal Classification and Morphology		
Chapter 3			Introduction		
Coastal Classification and Morphology			Coastal Classification		
Introduction	3-1	3-1	Drowned River Coasts- Estuaries	3-3	3-1
Coastal Classification	3-2	3-1	Drowned Glacial Erosion Coasts	3-4	3-9
Drowned River Coasts- Estuaries	3-3	3-1	River Deposition Coasts- Deltas	3-5	3-10
Drowned Glacial Erosion Coasts	3-4	3-9	Wind Deposition Coasts- Dunes	3-6	3-10
River Deposition Coasts- Deltas	3-5	3-10			
Wind Deposition Coasts- Dunes	3-6	3-10			

Subject	Paragraph	Page	Subject	Paragraph	Page
Appendix A References		A-1	Appendix G Geographic List of CERC Coastal Geologic and Monitoring Reports		G-1
Appendix B Glossary		B-1	Appendix H Field Reconnaissance for Coastal Erosion Study, Site Visit Checklist		H-1
Appendix C Acknowledgements		C-1	Appendix I General Procedures for Conducting Offshore Sand Inventory Assessment Studies		I-1
Appendix D List of Wave Information Studies (WIS) Reports		D-1			
Appendix E List of Selected Sources for Aerial Photography and Other Remote Sensing Data		E-1			
Appendix F Addresses of Government Agencies Producing Maps		F-1			

Chapter 1 Introduction

1-1. Purpose

The purpose of this manual is to provide an overview of coastal geology and a discussion of data sources and study methods applicable to coastal geological field studies. "Coastal geology" is defined as the science of landforms, structures, rocks, and sediments with particular emphasis on the coastal zone. Material in this manual has been adapted from textbooks and technical literature from the fields of geology, geomorphology, geophysics, oceanography, meteorology, and geotechnical engineering. The practicing scientist involved in coastal projects is expected to be able to obtain a general overview of most aspects of coastal geology and to be able to refer to the reference list for additional information on specific topics.

1-2. Applicability

This manual applies to all HQUSACE elements, major subordinate commands, districts, laboratories, and field operating activities having civil works responsibilities. The intended audience is engineers, geologists, and oceanographers who have had limited experience in the coastal zone and need to become more familiar with the many unique and challenging problems posed by the dynamic and intricate interplay among land, sea, and air that occur at the coast. "Coastal zone" is loosely defined as the region between the edge of the continental shelf and the landward limit of storm wave activity (to be discussed in more detail in Chapter 2). The definition is applicable to the edge of oceans, lakes, reservoirs, and estuaries - effectively any shore that is influenced by waves. For those with extensive coastal practice, we hope that this manual will provide review material and suitable references to enable them to address more challenging projects.

1-3. References

References cited in the text are listed in Appendix A. Because of the broad nature of this manual and the fact that different users have different needs, all of the references have been listed together in Appendix A, rather than dividing them into the categories of "required" and "related" publications. Certain high quality books specializing in coastal geology, such as Carter's (1988) *Coastal Environments*, Davis' (1985) *Coastal Sedimentary Environments*, and Pethick's (1984) *An Introduction to Coastal Geomorphology*, could be considered "required reading" for anyone working at the coast, but it is a gross

imposition to insist that the already busy coastal engineer read multi-hundred page texts before he is allowed to work at the shore. Therefore, it is hoped that the coastal worker will avail himself of the reference list, choosing works and reviewing appropriate sections that are most pertinent to his specific project or study area. Many of the citations are of a review nature and contain long bibliographies. A glossary of geologic terms is provided in Appendix B.

1-4. Background

a. Since man has ventured to the sea, he has been fascinated by the endless variety of geomorphic landforms and biological habitats that present themselves at the coast. With the exception of high altitude alpine, a full spectrum of environments is found around the world's coastlines. These range from icy arctic shores to rocky faulted coasts to temperate sandy barriers to tropical mangrove thickets, with a myriad of intermediate and mixed forms. Man has gone to the sea for food, for commerce, for war, and for beauty. He has built his homes and cities at the coast. He has also been hurt by the sea, terrorized by its occasional violence, and baffled by the changes that the sea has wrought on the land in remarkably short time spans. In hours, beaches disappear; in days, new inlets are cut; in a generation, cliffs crumble. His coastal works have often been buried in sand, swept away, or pounded into rubble, frustrating his most worthy engineering efforts. Why? What controls these mighty forces of change?

b. The answers have been elusive. Nevertheless, over the centuries, man has attempted to manage the power of the sea. With a disregard for the realities of nature and a surfeit of *hubris*¹, he has built ever more massive structures to protect cities placed in ever more precarious locations. Unfortunately, many of these coastal works have been constructed with little attention to the overall physical setting in which they were placed, with little respect for the delicate balances of sediment supply, water quality, and biological habitat that are intimate elements of the coastal environment.

c. In the latter part of the 20th century, it has become clear that three primary factors shape the coast: the regional *geology* which provides the setting, the

¹*Hubris*, a Greek term which cannot be fully translated, represents an attitude of overweening pride or arrogance - the end result of a search for self-assertion that challenges everything and defies everyone.

physical and *dynamic processes* which affect it, and the *ecology* and *biology* of the plants and animals that inhabit it. This manual concentrates on the first of these topics, geology. This broad subject encompasses both the geomorphology (the shape and form) of the landforms and the nature of the ancient strata that underlie or outcrop in the region. The forces that shape, and are shaped by, the coast are part of the overall picture, although here geology merges with the other earth sciences of meteorology and oceanography.

d. This volume has ambitious goals:

- To review overall geological, environmental, and climatological settings of the world's coasts.
- To describe particular shore types in detail.
- To explain how shore types are created by and interact with the forces of waves, currents, and weather (sometimes known as "morphodynamics").
- To describe field methods and data analysis procedures applicable to field studies at the coast.

e. The emphasis in this volume is on features and landforms that range in size from centimeters to kilometers and are formed or modified over time scales of minutes to millennia (Figure 1-1). Micro-scale geological interactions, such as the movement of individual grains in fluid flow or the electrochemical attraction between clay platelets in cohesive sediments, are left to specialty texts. Because of space and time limitations, it has been impossible to present more than a brief introduction to meteorology and oceanography.

f. Another subject of crucial importance to coastal researchers is biology. The biological environment is partly established by the geological setting. Conversely, biology affects coastal geology in many ways:

- Coral reefs and mangroves have created large stretches of coastline.
- Cliff erosion is accelerated by the chemical solution and mechanical abrasion caused by some organisms.
- Dunes and barriers are stabilized by plants.

- Lagoons and estuaries slowly fill with the by-products of plants and the sediment they trap, forming wetlands.

These topics are reviewed in this text, but details of the flora and fauna that inhabit the coast unfortunately cannot be covered here.

g. Geotechnical aspects of coastal geology, such as the choice and use of rock as a building material or calculation of underwater slope stability, are not covered in this manual. Eckert and Callender (1987) summarize many aspects of geotechnical engineering in the coastal zone. Use of rock in coastal and shoreline engineering is covered in Construction Industry Research and Information Association (1991) and EM 1110-2-2302.

h. This manual will have served its purpose if it convinces the reader that no coastal feature or setting exists in isolation, but rather that every part is influenced by the other, that the coast is a living entity that changes, grows, and evolves. An understanding of, and a respect for, the underlying geological setting of any particular coastal site is an absolute requirement for safe, economic, and successful coastal project planning, design, construction, maintenance, and administration.

1-5. Organization of This Manual

This manual covers three broad types of information:

- Basic background concepts related to coastal geology.
- Descriptions of specific coastal forms and environments.
- Guidance on conducting coastal geological investigations.

a. Chapter 2 provides general background information on coastal nomenclature and concepts like datums and water levels. It also discusses waves and tides and changes in sea level - processes which cause geologic change in the coastal zone. The intent is to give a reader a basic understanding of some of the processes which cause coastal change and serve as a foundation for the discussions of specific coastal features in the following chapters.

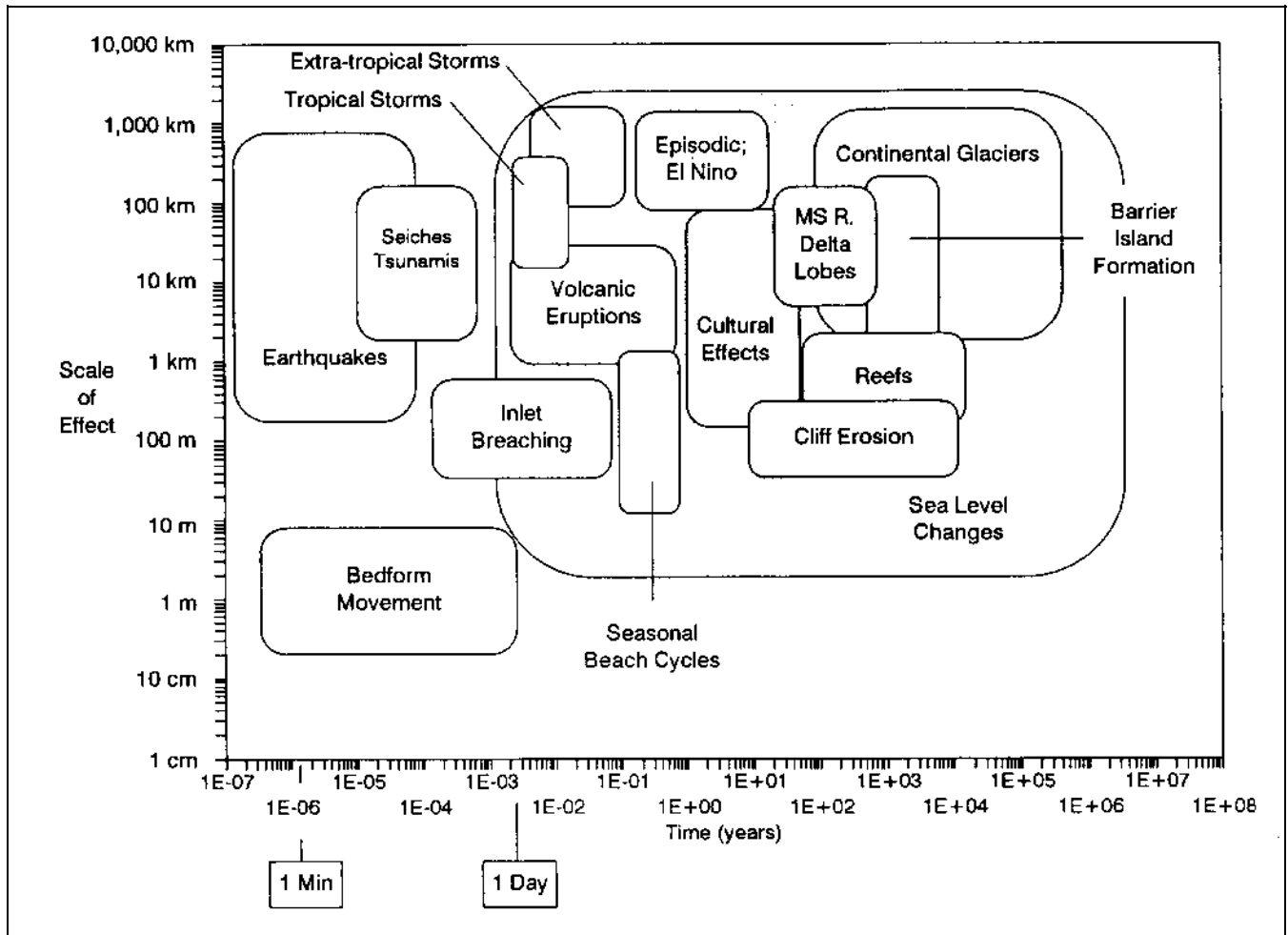

Figure 1-1. Temporal and spatial scales of phenomena addressed in this manual

b. Chapter 3 introduces the coastal classification scheme of Francis Shepard (1937; 1948; 1963; 1973) and continues with discussions and examples of specific coastlines following Shepard's outline.

c. Chapter 4 discusses morphodynamics of deltas, inlets, sandy shorefaces, and cohesive shorefaces.

d. Chapter 5 is a description of technologies for examining and assessing the geologic and geomorphic history of coasts. The chapter is not a step-by-step "how-to" manual for conducting coastal studies but rather is a description of what type of data to acquire, what types of instruments to use, how to anticipate data errors, and how to analyze data, either acquired directly from field studies or obtained from secondary sources. An

underlying assumption in this chapter is that the coastal researcher will, in many cases, have a large amount of data already available and will need to organize, examine, and use this material to the best possible advantage before conducting additional field studies. For this reason, emphasis is placed on data display and organization and error checking.

1-6. Proponent

The U.S. Army Corps of Engineers proponent for this manual is the Geotechnical and Materials Branch, Engineering Division, Directorate of Civil Works (CECW-EG). Any comments or questions regarding the content of this manual should be directed to the proponent at the following address:

EM 1110-2-1810
31 Jan 95

Headquarters, U.S. Army Corps of Engineers
Attn: CECW-EG
20 Massachusetts Ave., NW
Washington, DC 20314-1000

1-7. Acknowledgement

Authors and reviewers of this manual are listed in Appendix C.

Chapter 2 Coastal Terminology and Geologic Environments

2-1. General

Modern coastal environments are products of many complex interacting processes which are continually modifying rocks and sediments. Characterizing coastal geology is beset by difficulties in establishing precise and singular definitions of geologic features and processes. Sections 2-2 and 2-3 of this chapter describe the coastal zone and define broad terms such as “coast” and “shoreline.” Section 2-4 discusses water level datums and tide terminology. The remainder of the chapter presents an overview of the geological, oceanographic, biological, and human factors that shape and modify landforms found along the shore. A better understanding of each factor is necessary in a systematic appraisal of the geology of a given project area.

2-2. Coastal Zone Definitions and Subdivisions

a. Introduction.

(1) Many coastal zone features and subdivisions are difficult to define because temporal variability or gradational changes between features obscure precise boundaries. In addition, nomenclature is not standardized, and various authors describe the same features using different names. If the same name is used, the intended boundaries may differ greatly. This ambiguity is especially evident in the terminology and zonation of shore and littoral areas. In the absence of a widely accepted standard nomenclature, coastal researchers would do well to accompany reports and publications with diagrams and definitions to ensure that readers will fully understand the authors' use of terms.

(2) The following subparagraphs present a suggested coastal zone definition and subdivision based largely, but not exclusively, on geological criteria. It does not necessarily coincide with other geological-based zonations or those established by other disciplines. It should be borne in mind that coastal zone geology varies greatly from place to place, and the zonations discussed below do not fit all regions of the world. For example, coral atolls are without a coast, shoreface, or continental shelf in the sense defined here. The Great Lakes and other inland water bodies have coasts and shorefaces but no continental shelves. Thus, while divisions and categories are

helpful in describing coastal geology, flexibility and good descriptive text and illustrations are always necessary for adequate description of a given region or study site.

b. Coastal zone. In this manual, we suggest that *coastal zone* be defined as the transition zone where the land meets water, the region that is directly influenced by marine or lacustrine hydrodynamic processes. The coastal zone extends offshore to the continental shelf break and onshore to the first major change in topography above the reach of major storm waves. We exclude upland rivers from this discussion but do include river mouth deltas, where morphology and structure are a result of the dynamic interplay of marine and riverine forces. The coastal zone is divided into four subzones (Figure 2-1):

- Coast.
- Shore.
- Shoreface.
- Continental shelf.

c. Coast. The *coast* is a strip of land of indefinite width that extends from the coastline inland as far as the first major change in topography. Cliffs, frontal dunes, or a line of permanent vegetation usually mark this inland boundary. On barrier coasts, the distinctive back barrier lagoon/marsh/tidal creek complex is considered part of the coast. It is difficult to define the landward limit of the coast on large deltas like the Mississippi, but the area experiencing regular tidal exchange can serve as a practical limit (in this context, New Orleans would be considered “coastal”). The seaward boundary of the coast, the *coastline*, is the maximum reach of storm waves. Definition and identification of the coastline for mapping purposes are discussed in detail in Chapter 5, Section e. On shorelines with plunging cliffs, the coast and coastline are essentially one and the same. It is difficult to decide if a seawall constitutes a coast; the inland limit might better be defined at a natural topographic change.

d. Shore. The *shore* extends from the low-water line to the normal landward limit of storm wave effects, i.e., the coastline. Where beaches occur, the shore can be divided into two zones: *backshore* (or berm) and *foreshore* (or beach face). The foreshore extends from the low-water line to the limit of wave uprush at high tide. The backshore is horizontal while the foreshore slopes seaward. This distinctive change in slope, which marks the juncture of the foreshore and backshore, is called the

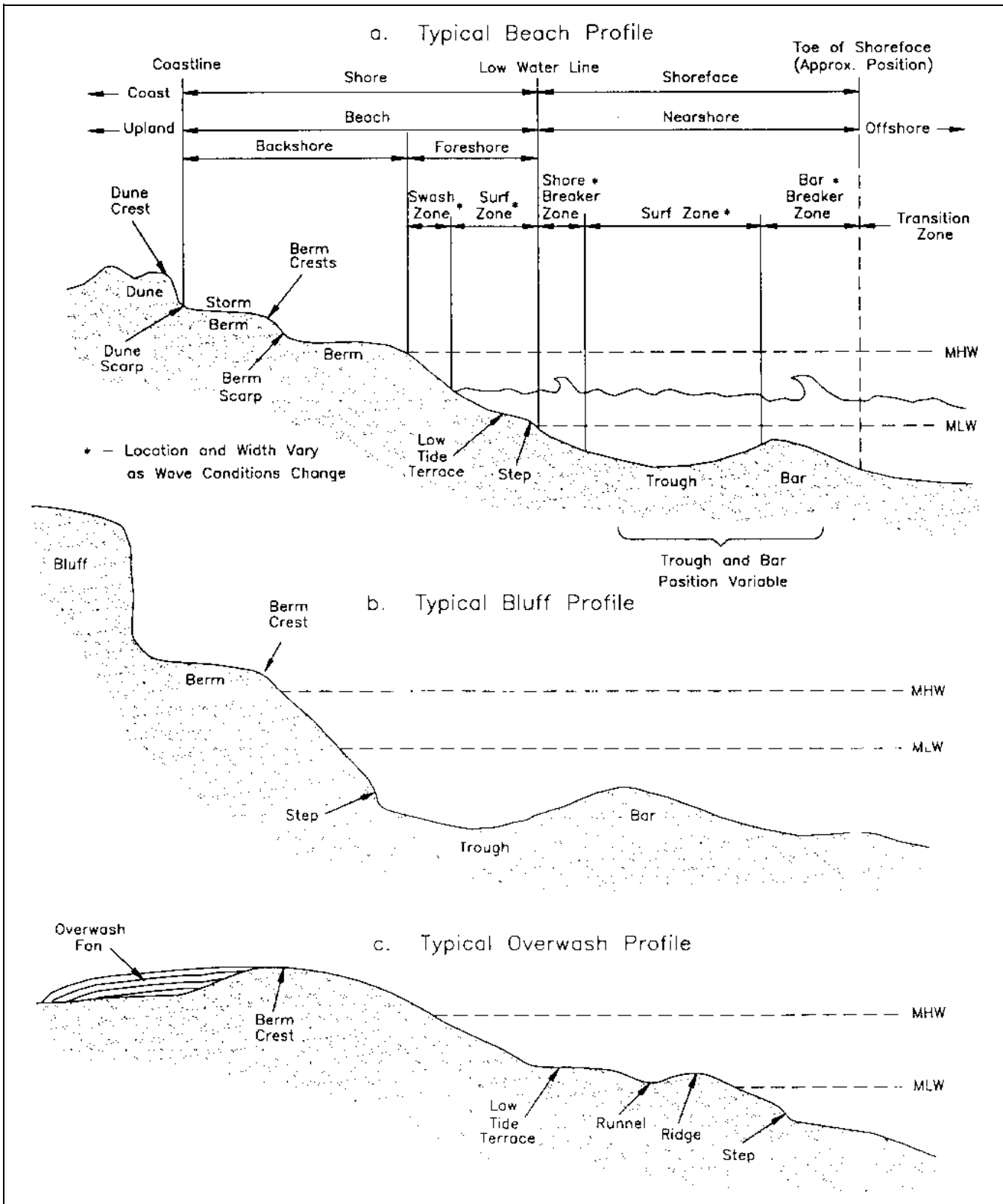

Figure 2-1. Definition of terms and features describing the coastal zone

beach or berm crest. A more detailed exposition of beach morphology and nomenclature is presented in Chapter 3.

e. Shoreface. The *shoreface* is the seaward-dipping zone that extends from the low-water line offshore to a gradual change to a flatter slope denoting the beginning of the continental shelf. The continental shelf transition is the *toe of the shoreface*. Its location can only be approximately marked due to the gradual slope change. Although the shoreface is a common feature, it is not found in all coastal zones, especially along low-energy coasts or those consisting of consolidated material. The shoreface can be delineated from survey profiles or from bathymetric charts such as the National Ocean Survey (NOS) 1:2000 series. The shoreface, especially the upper part, is the zone of most frequent and vigorous sediment transport.

f. Continental shelf. The *continental shelf* is the shallow seafloor that borders most continents (Figure 2-2). The shelf floor extends from the toe of the shoreface to the shelf break where the steeply inclined continental slope begins. It has been common practice to subdivide the shelf into inner-, mid-, and outer zones, although there are no regularly occurring geomorphic features on most shelves that suggest a basis for these subdivisions. Although the term *inner shelf* has been widely used, it is seldom qualified beyond arbitrary depth or distance boundaries. Site-specific shelf zonation can be based on project requirements and local geologic conditions. Some

coastal areas (e.g., bays and the Great Lakes) do not extend out to a continental shelf.

2-3. Geologic Time and Definitions

a. Geologic fossil record. Geologists have subdivided geologic time into *eras*, *periods*, and *epochs* (Figure 2-3). Pioneering geologists of the 1800's based the zonations on the fossil record when they discovered that fossils in various rock formations appeared and disappeared at distinct horizons, thus providing a means of comparing and correlating the relative age of rock bodies from widely separated locations. For example, the boundary between the *Mesozoic* ("interval of middle life") and the *Cenozoic* ("interval of modern life") eras is marked by the disappearance of hundreds of species, including the dinosaurs, and the appearance or sudden proliferation of many new species (Stanley 1986). The fossil time scale was relative, meaning that geologists could compare rock units but could not assign absolute ages in years. It was not until the mid-20th century that scientists could measure the absolute age of units by radiometric dating. The geologic times listed in Figure 2-3, in millions of years, are best estimates based on radiometric dates.

b. Geologic time considerations for coastal engineering. The epochs of most concern to coastal engineers and geologists are the *Pleistocene* and *Recent* (also commonly

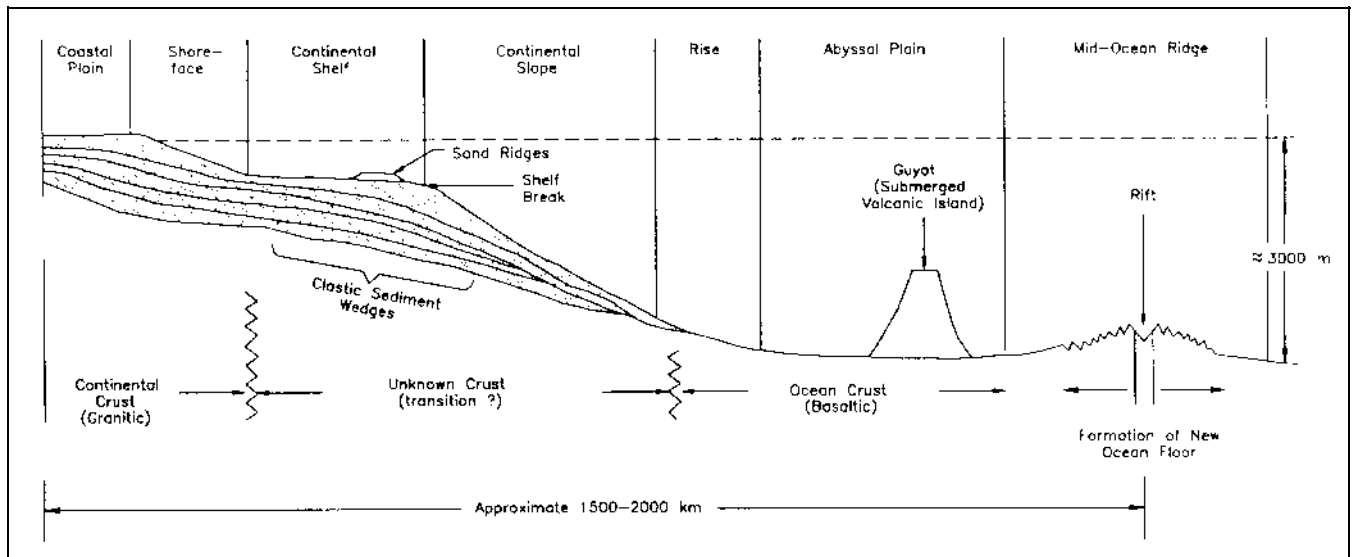

Figure 2-2. Continental shelf and ocean floor along a trailing-edge continent (i.e., representative of the U.S. Atlantic Ocean coast) (figure not to scale, great vertical exaggeration)

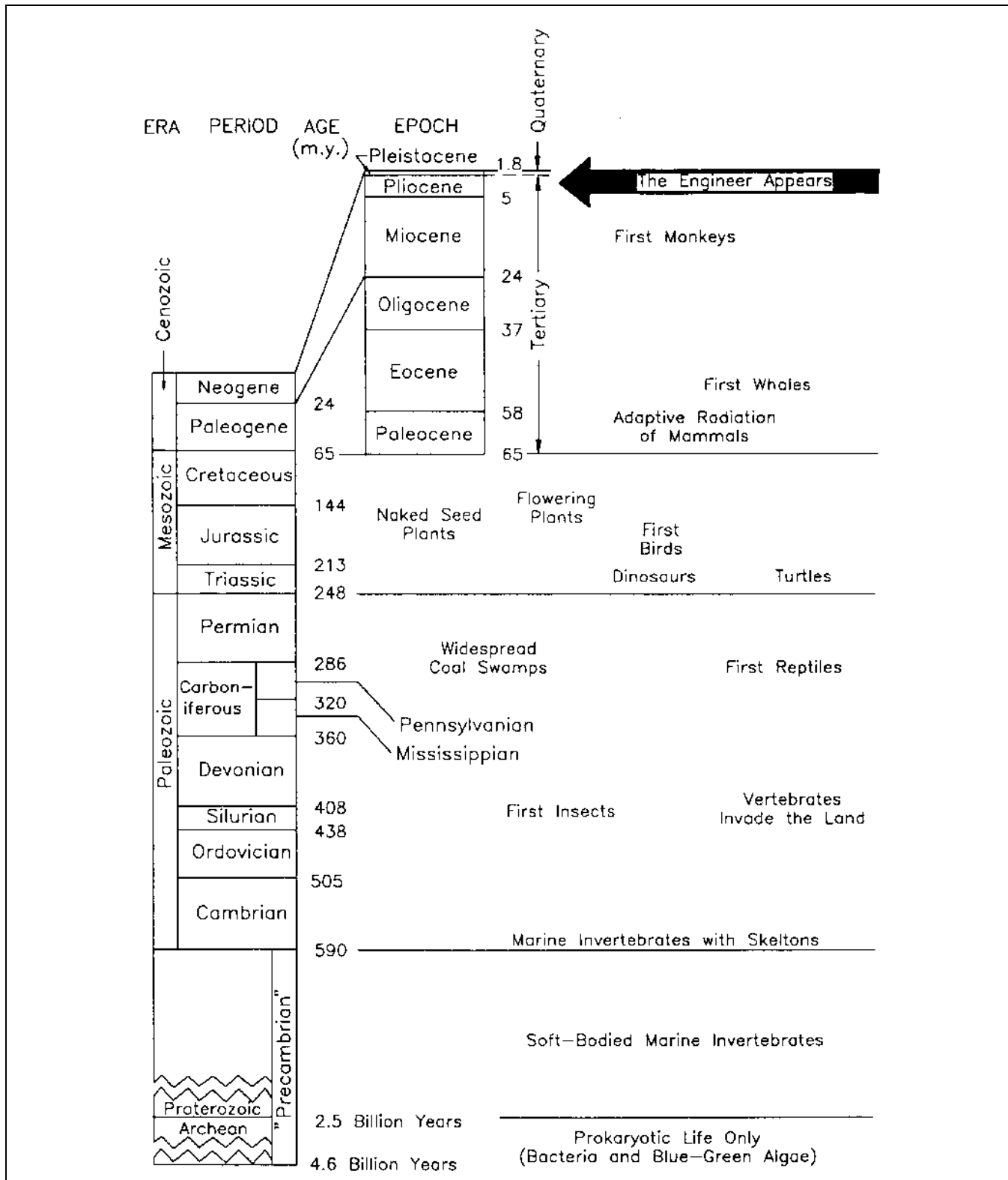

Figure 2-3. Geologic time scale. Chronological ages are based on radiometric dating methods (figure adapted from Stanley (1986))

known as the *Holocene*), extending back a total of 1.8 million years before present (my). *Quaternary* is often used to designate the period comprising the Pleistocene and Recent Epochs.

(1) The Pleistocene Epoch was marked by pronounced climatic fluctuations in the Northern Hemisphere - changes that marked the modern Ice Age. The continental glaciers that periodically covered vast areas of the northern continents during this time had profound influence on the surficial geology. Many geomorphic features in North America were shaped or deposited by the ice sheets (discussed in greater detail in Chapter 3). Flint's (1971) *Glacial and Quaternary Geology* is an exhaustive study of the effects of Pleistocene ice sheets on North American geology.

(2) The Holocene Transgression appears to have started around 15-18 thousand years ago with the beginning of global sea level rise. Presumably, a concurrent event was the waning of the continental glaciers possibly caused by warming climate around the world. Most of the dynamic, morphological features that we associate with the active coastal environment are Holocene in age, but the preexisting geology is often visible, as well. For example, the drumlins of Boston Harbor and the end moraine islands of southern New England (Long Island, Martha's Vineyard, and Block and Nantucket Islands) are deposits left by the Wisconsin stage glaciers (Woodsworth and Wigglesworth 1934), but barrier spits and beaches found along these shores are more recent (Holocene) features.

(3) North American glacial stages¹. Worldwide climatic fluctuations and multiple glacial and interglacial stages were the overwhelming Quaternary processes that shaped the surficial geomorphology and biological diversity of our world. Major fluctuations in eustatic, or worldwide, sea level accompanied the waxing and waning of the continental glaciers. Oxygen isotope analysis of deep sea sediments suggests that there were as many as nine glacial and ten interglacial events in the last 700,000 years (Kraft and Chrzastowski 1985). North American stages and approximate ages are listed in Table 2-1. The most recent glacial stage was the Wisconsin in North

¹ Stage is a time term for a major subdivision of a glacial epoch, including the glacial and interglacial events (Bates and Jackson 1984).

America and the Würm in Europe, during which sea level was more than 100 m below present. In northern latitude coasts, the coastal worker will often encounter geologic and geomorphic evidence of the Wisconsin glacial stage. Less evidence remains of the earlier North American stages except raised shore terraces along parts of the U.S. Atlantic and Gulf coasts (e.g., see Winkler 1977; Winkler and Howard 1977).

2-4. Water Level Datums and Definitions

Critical in evaluating sea level information or in constructing shoreline change maps are the level and type of datum used. Because water levels are not constant over space and time, depths and elevations must be referenced from established datums. Tides are defined as the periodic rise and fall of water in coastal areas resulting from gravitational interactions of the earth, sun, and moon. *Water levels* are defined as the height, or stage, of water in lakes and reservoirs resulting from rainfall, snow melt, and other sources of drainage or seepage (EM 1110-2-1003).

a. Open coast (ocean) tidal datums. When elevations are referred to a tidal reference plane in coastal waters, *mean lower low water* (mllw) is normally used as the vertical datum (EM 1110-2-1003). For specific project requirements, other datums are sometimes used: *mean low water* (mlw), *mean sea level* (msl), *mean tide level* (mtl), *mean high water* (mhw), *mean higher high water* (mhhw) (Figure 2-4 and Table 2-2). To establish these datums, tide heights are collected and mean values computed by the NOS and related to a specific 19-year cycle known as the National Tidal Datum Epoch. Because of varying relative sea level in many areas, tidal datums are constantly changing and require continuous monitoring and updating. Some areas of the United States have established regional datums. These are based on combinations of other datums (e.g., *mean low gulf* (mlg) for the Gulf of Mexico), or on local measurements of water level over different periods. On project maps and documentation, all tidal datums must be clearly related to the fixed national survey datums (i.e., the National Geodetic Vertical Datum, 1929 adjustment (NGVD 29) or the North American Datum of 1983 (NAD 83)). Specific definitions of various datums and their relationship with geodetic datums are listed in Harris (1981), EM 1110-2-1414, and in references from the NOS.

Table 2-1
North American Pleistocene Glacial and Interglacial Stages

Age (approx. years) ¹	Glacial and Interglacial Stages	Age (approx. years) ²
12,000-Present	Recent (Holocene)	10,000-Present
150,000-12,000	Wisconsin	100,000-10,000
350,000-150,000	Sangamon Interglacial	300,000-100,000
550,000-350,000	Illinoian	450,000-300,000
900,000-550,000	Yarmouth Interglacial	1,100,000-450,000
1,400,000-900,000	Kansan	1,300,000-1,100,000
1,750,000-1,400,000	Aftonian Interglacial	1,750,000-1,300,000
>2,000,000-1,750,000	Nebraskan	2,000,000-1,750,000
>2,000,000(?)	Older glaciations	

¹ Dates based on generalized curve of ocean-water temperatures interpreted from foraminifera in deep sea cores (curve reproduced in Strahler (1981))

² Dates from Young (1975) (original sources not listed)

b. Water level datums of the Great Lakes of North America (Lakes Superior, Huron, Michigan, Erie, and Ontario).

(1) Low water reference datums used on the Great Lakes and their connecting waterways are currently based on the International Great Lakes Datum (IGLD) 1985. This datum, established and revised by the Coordinating Committee on Great Lakes Basic Hydraulic and Hydrologic Data, replaced IGLD 1955 in January 1992. The main differences between IGLD 1955 and IGLD 1985 are corrections in the elevations assigned to water levels (Table 2-3). This is a result of benchmark elevation changes due to adjustments for crustal movements, more accurate measurement of elevation differences, a new reference zero point location, and an expanded geodetic network. The reference zero point of IGLD 1985 is at Rimouski, Québec (Figure 2-5). The new 1985 datum establishes a set of elevations consistent for surveys taken within the time span 1982-1988. IGLD 1985 is referred to the North American Vertical Datum (NAVD) 1988. Note that the IGLD's are not parallel to NGVD 29 or NAVD 1988 because the Great Lakes datums are dynamic or geopotential heights that represent the hydraulic structure of the lakes and connecting waterways (EM 1110-2-1003).

(2) On the Great Lakes, astronomic tides have little influence on water levels. Instead, atmospheric pressure changes and winds cause most of the short-term water level fluctuations. Long-term changes are caused by

regional hydrographic conditions such as precipitation, runoff, temperature and evapo-transpiration, snow melt, and ice cover (Great Lakes Commission 1986). Global climate variations, in turn, influence these factors. Crustal movements also influence levels. For example, the earth's crust at the eastern end of Lake Superior is rebounding about 25 cm/century faster than the western end, resulting in a drop of the datums (apparent higher water) at the west end at Duluth. Aquatic plant life and man-made control structures are additional factors that influence the exceedingly complex cycles of water level changes in the Great Lakes. As a result, the concept of mean water level is not applicable to these inland Great Lakes. Attempts to predict lake levels have not been entirely successful (Walton 1990).

2-5. Factors Influencing Coastal Geology

The coast is probably the most diverse and dynamic environment found anywhere on earth. Many geologic, physical, biologic, and anthropomorphic (human) factors are responsible for shaping the coast and keeping it in constant flux. Ancient geological events created, modified, and molded the rock and sediment bodies that form the foundation of the modern coastal zone. Over time, various physical processes have acted on this preexisting geology, subsequently eroding, shaping, and modifying the landscape. These processes can be divided into two broad classes: active forces, like waves and tides, which occur constantly, and long-term forces and global changes that affect the coast over time scales of years.

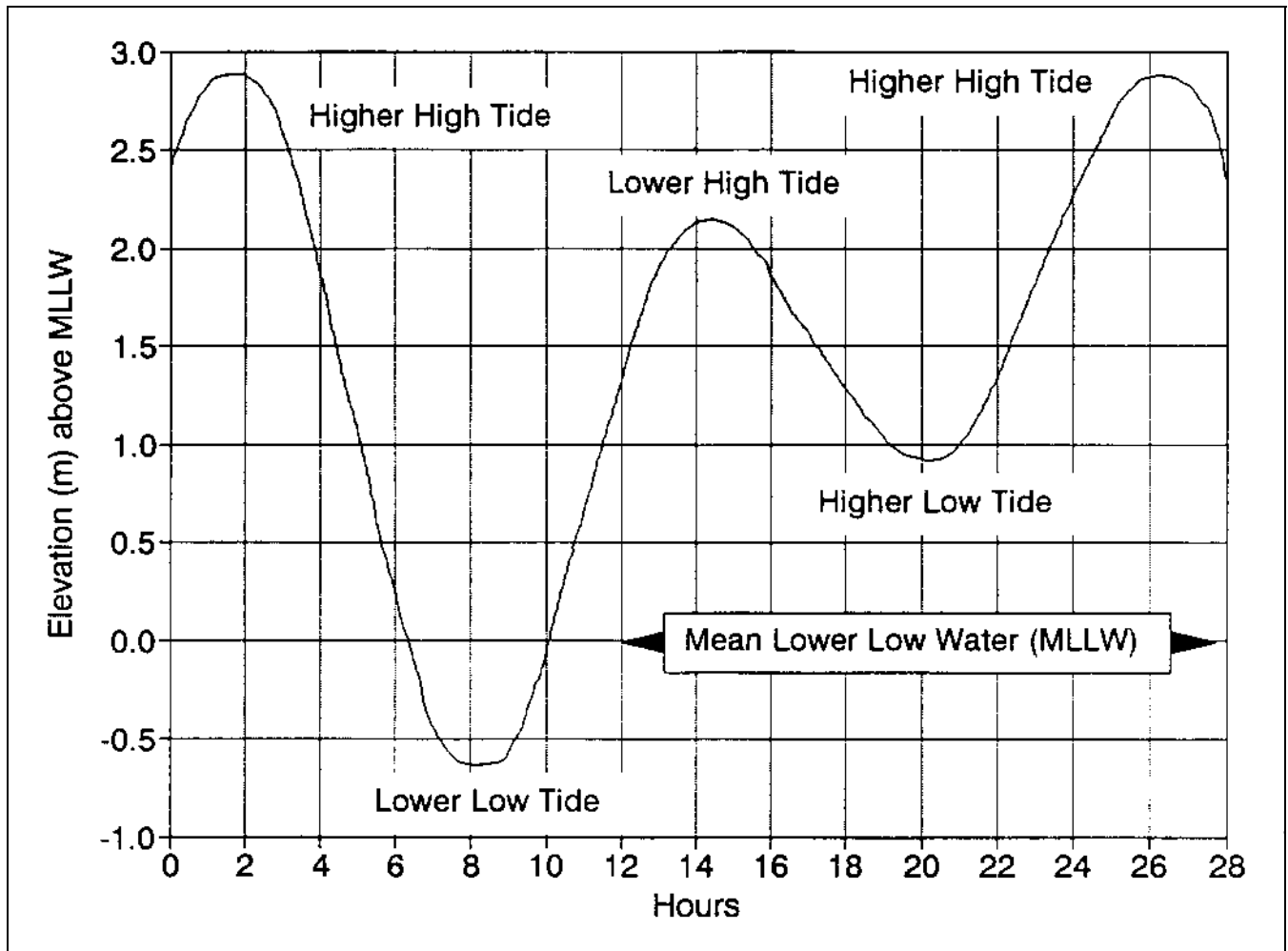

Figure 2-4. Tide curve for Yaquina Bay, Oregon (based on 6 years of observations). By definition, mean lower low water (mllw) is zero (from Oregon (1973))

a. *Underlying geology and geomorphology.*¹ The geologic setting of a coastal site controls surficial geomorphology, sediment type and availability, and overall gradient. The geology is modified by physical processes (e.g., waves and climate), biology, and man-made activities, but the overall “look” of the coast is primarily a function of the regional lithology and tectonics. These topics are discussed in the following paragraphs.

(1) *Lithology.* *Lithology* concerns the general character of rock or sediment deposits and is an important factor shaping the present coast. The most critical lithologic parameters responsible for a rock’s susceptibility to

¹ *Geomorphology* is a study of natural topographic features and patterns forming the earth’s surface, including both terrestrial and subaqueous environments.

erosion or dissolution are the mineral composition and the degree of consolidation. Striking contrasts often occur between coasts underlain by consolidated rock and those underlain by unconsolidated material. Marine processes are most effective when acting on uncemented material, which is readily sorted, redistributed, and sculpted into forms that are in a state of dynamic equilibrium with incident energy.

(a) *Consolidated coasts.* Consolidated rock consists of firm and coherent material. Coastal areas consisting of consolidated rock are typically found in hilly or mountainous terrain. Here, erosional processes are usually dominant. The degree of consolidation greatly influences the ability of a rocky coastline to resist weathering and erosion. Resistance depends on susceptibility to mechanical

Table 2-2
Tidal Datums and Definitions, Yaquina Bay, Oregon¹

Tide Staff (m)	Datum and Definition
4.42	Extreme high tide. The highest projected tide that can occur. It is the sum of the highest predicted tide and the highest recorded storm surge. Such an event would be expected to have a very long recurrence interval. In some locations, the effect of a rain-induced freshet must be considered. The extreme high tide level is used for the design of harbor structures.
3.85	Highest measured tide. The highest tide observed on the tide staff.
3.14	Highest predicted tide. Highest tide predicted by the Tide Tables.
2.55	Mean higher high water. The average height of the higher high tides observed over a specific interval. Intervals are related to the moon's many cycles, ranging from 28 days to 18.6 years. The time length chosen depends upon the refinement required. The datum plane of mhhw is used on National Ocean Survey charts to reference rocks awash and navigation clearances.
2.32	Mean high water. The average of all observed high tides. The average is of both the higher high and of the lower high tide recorded each day over a specific period. The datum of mhw is the boundary between upland and tideland. It is used on navigation charts to reference topographic features.
1.40	Mean tide level. Also called half-tide level. A level midway between mean high water and mean low water. The difference between mean tide level and local mean and sea level reflects the asymmetry between local high and low tides.
1.37	Local mean sea level. The average height of the water surface for all tide stages at a particular observation point. The level is usually determined from hourly height readings.
1.25	Mean sea level. A datum based upon observations taken over several years at various tide stations along the west coast of the United States and Canada. It is officially known as the Sea Level Datum of 1929, 1947 adj. Msl is the reference for elevations on U.S. Geological Survey Quadrangles. The difference between msl and local msl reflects many factors ranging from the location of the tide staff within an estuary to global weather patterns.
0.47	Mean low water. Average of all observed low tides. The average is of both the lower low and of the higher low tides recorded each day over a specific period. The mlw datum is the boundary line between tideland and submerged land.
0.00	Mean lower low water. Average height of the lower low tides observed over a specific interval. The datum plane is used on Pacific coast nautical charts to reference soundings.
-0.88	Lowest predicted tide. The lowest tide predicted by the Tide Tables.
-0.96	Lowest measured tide. Lowest tide actually observed on the tide staff.
-1.07	Extreme low tide. The lowest estimated tide that can occur. Used by navigation and harbor interests.

¹Based on six years of observations at Oregon State University marine science center dock.

(From Oregon (1973))

and chemical weathering, hardness and solubility of constituent minerals and cementation, nature and density of voids, and climatic conditions. Rock type, bedding, jointing, and orientation of the strata greatly influence the geomorphic variability of the shoreline (Figure 2-6). For example, large portions of the shorelines of Lakes Superior, Huron, and Ontario are rocky and prominently display the structure of the underlying geology.

- *Mechanical weathering* is the disintegration of rock without alteration of its chemical nature. Examples of mechanical weathering include fluctuations in temperature (causing repetitive thermal expansion and contraction), expansion due to crystallization from salt or ice,

wetting and drying, overburden fluctuations, and biological activity.

- *Chemical weathering* is the decomposition of rock material by changes in its chemical composition. Examples of this process include hydration and hydrolysis, oxidation and reduction, solution and carbonation, chelation, and biochemical reactions.

(b) Unconsolidated coasts. In contrast to consolidated coasts, depositional and erosional processes dominate unconsolidated coasts, which are normally found on low relief coastal plains or river deltas. Commonly,

Table 2-3
Low Water (chart) Datum for IGLD 1955 and IGLD 1985

Location	Low Water Datum in Meters	
	IGLD 1955	IGLD 1985
Lake Superior	182.9	183.2
Lake Michigan	175.8	176.0
Lake Huron	175.8	176.0
Lake St. Clair	174.2	174.4
Lake Erie	173.3	173.5
Lake Ontario	74.0	74.2
Lake St. Lawrence at Long Sault Dam, Ontario	72.4	72.5
Lake St. Francis at Summerstown, Ontario	46.1	46.2
Lake St. Louis at Pointe Claire, Québec	20.3	20.4
Montréal Harbour at Jetty Number 1	5.5	5.6

(From Coordinating Committee on Great Lakes Basic Hydraulic and Hydrologic Data (1992))

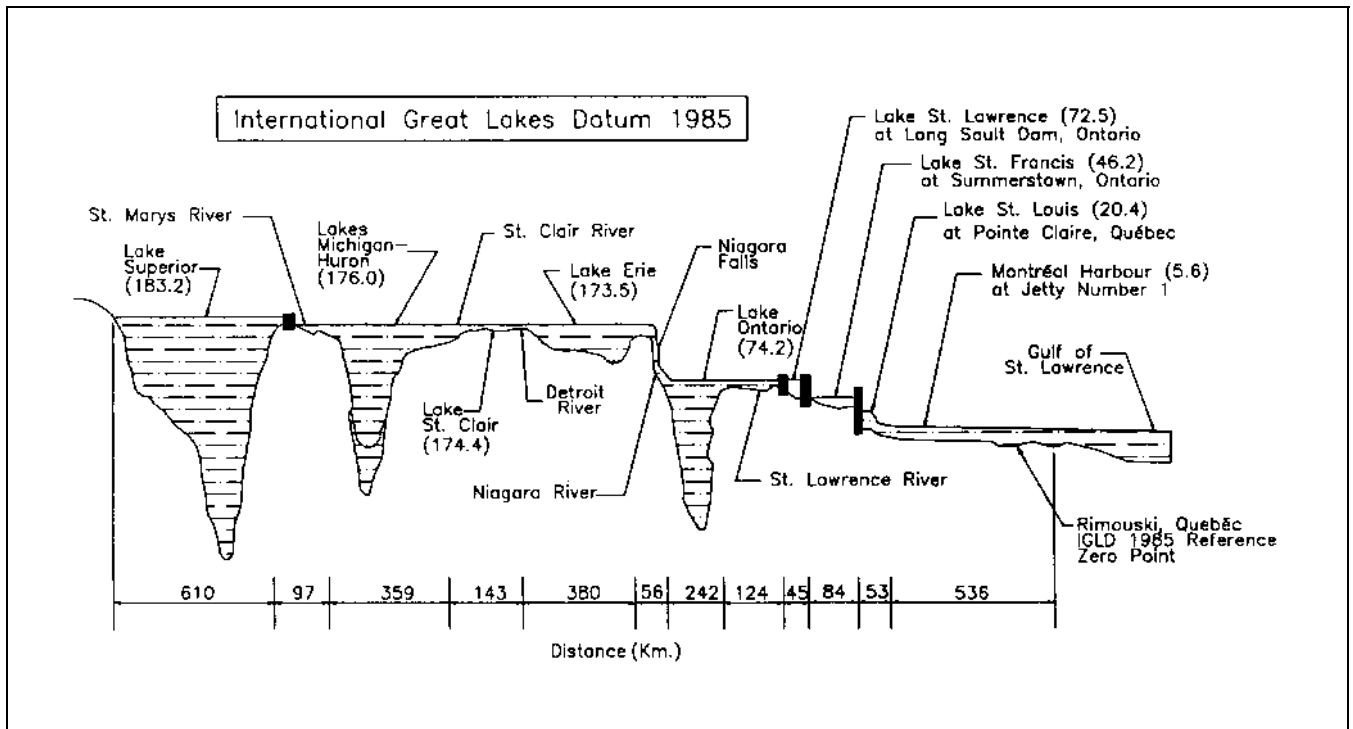

Figure 2-5. The reference zero point for IGLD 1985 at Rimouski, Quebec is shown in its vertical and horizontal relationship to the Great Lakes-St. Lawrence River System. Low water datums for the lakes in meters (from Coordinating Committee on Great Lakes Basic Hydraulic and Hydrologic Data (1992))

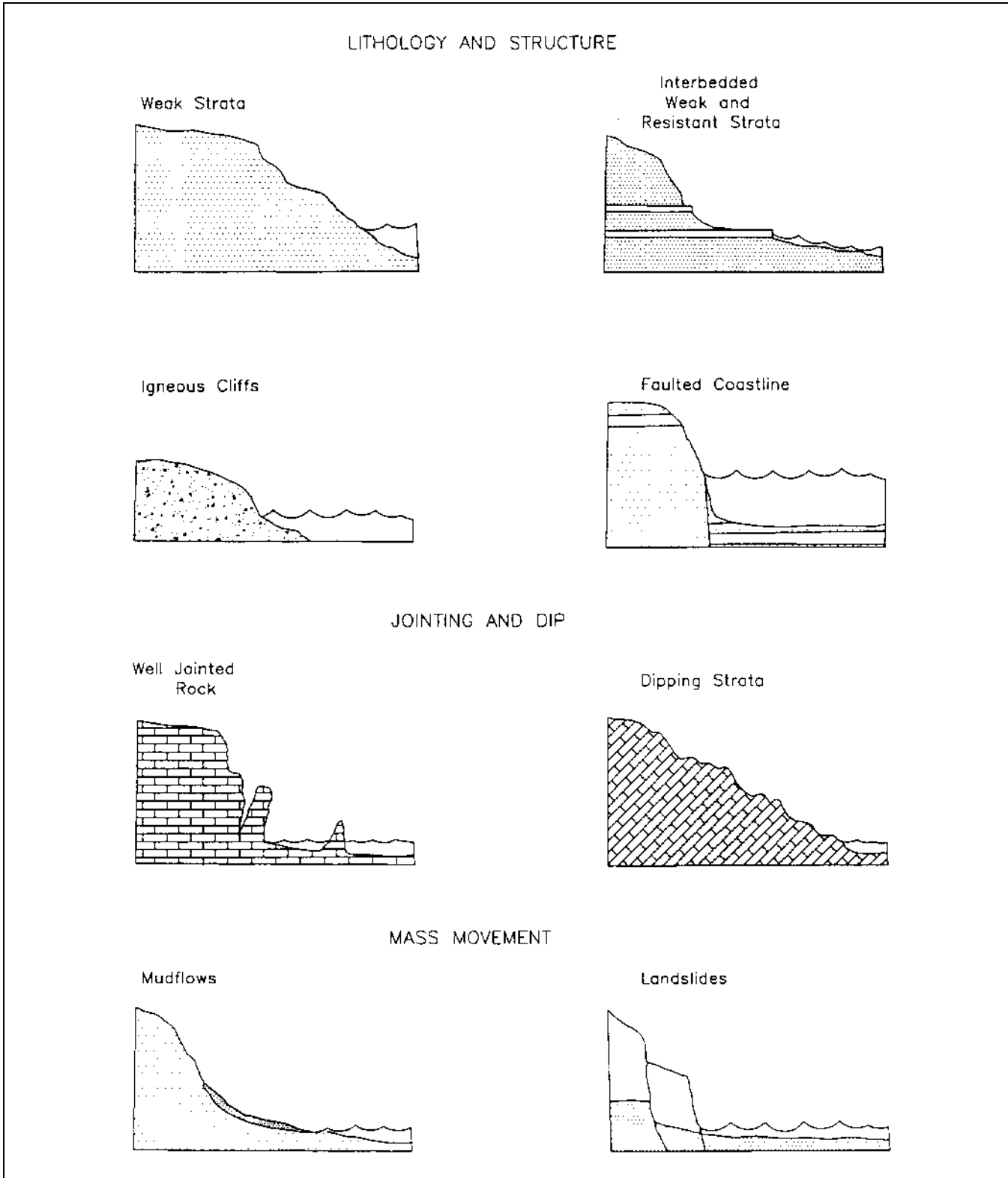

Figure 2-6. Cross-section views of aspects of geomorphic variability attributable to lithology, structure, and mass movement along semi-consolidated and consolidated coasts (from Mossa, Meisberger, and Morang 1992)

shorelines have been smoothed by erosion of protruding headlands and by the deposition of barrier islands, spits, and bay mouth barriers. Along unconsolidated coasts, large amounts of sediment are usually available, and morphological changes occur rapidly. Waves and currents readily alter relict geomorphic features in this environment. Figure 2-7 illustrates features associated with unconsolidated depositional environments. The Atlantic and Gulf of Mexico coasts of the United States are mostly unconsolidated, depositional environments (except select locations like the rocky shores in New England).

(2) Tectonics. Forces within the earth's crust and mantle deform, destroy, and create crustal material. These tectonic activities produce structural features such as faults and folds (anticlines and synclines) (Figure 2-8). Tectonic movements produce large-scale uplift and subsidence of land masses. The west coast of the United States is an example of a tectonically dominated coast, in sharp contrast to the east coast, which is mostly depositional. According to Shepard's (1973) coastal classification, a fault coast is characterized by a steep land slope that continues beneath the sea surface. The most

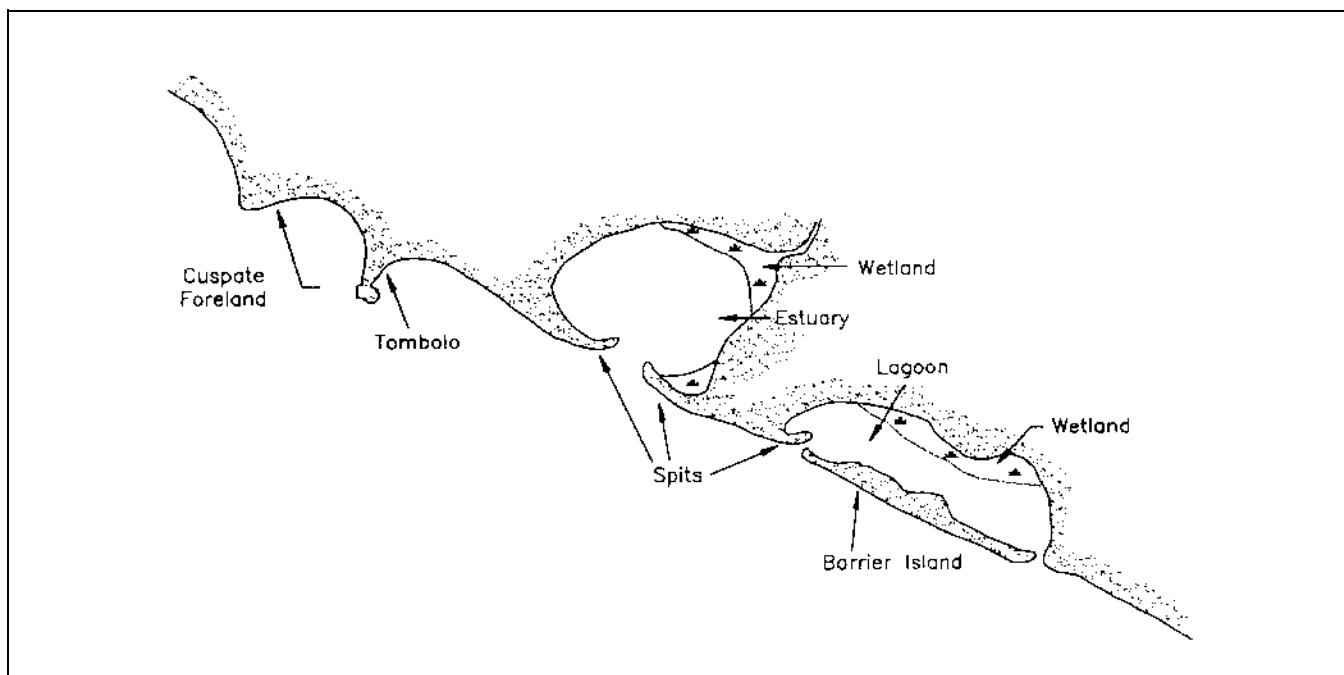

Figure 2-7. Examples of features associated with depositional coastal environments. These features consist mostly of unconsolidated sediments (after Komar (1976))

prominent feature exhibited by a fault coast is a scarp where normal faulting has recently occurred, dropping a crustal block so that it is completely submerged and leaving a higher block standing above sea level (Figure 2-9). Examples of fault-block coasts are found in California. Active faults such as the Inglewood-Rose Canyon structural zone outline the coast between Newport Bay and San Diego, and raised terraces backed by fossil cliffs attest to continuing tectonism (Orme 1985).

(3) Volcanic coasts. The eruption of lava and the growth of volcanoes may result in large masses of new crustal material. Conversely, volcanic explosions or collapses of existing volcanic cones can leave huge voids in the earth's surface known as calderas. When calderas and cones occur in coastal areas, the result is a coastline

dominated by circular convex and concave contours (Shepard 1973). Coastlines of this sort are common on volcanic islands such as the Aleutians (Figure 2-10). The morphology of volcanic shores is discussed in more detail in Chapter 3.

b. High-frequency dynamic processes. The following paragraphs discuss processes that impart energy to the coastal zone on a continuous or, as with storms, repetitive basis. Any geological or engineering investigation of the coastal zone must consider the sources of energy that cause erosion, move sediment, deposit sediment, and result in the rearrangement of the preexisting topography. These processes also result in temporary changes in water levels along the coast. Long-term sea level changes are discussed in paragraph 2-6.

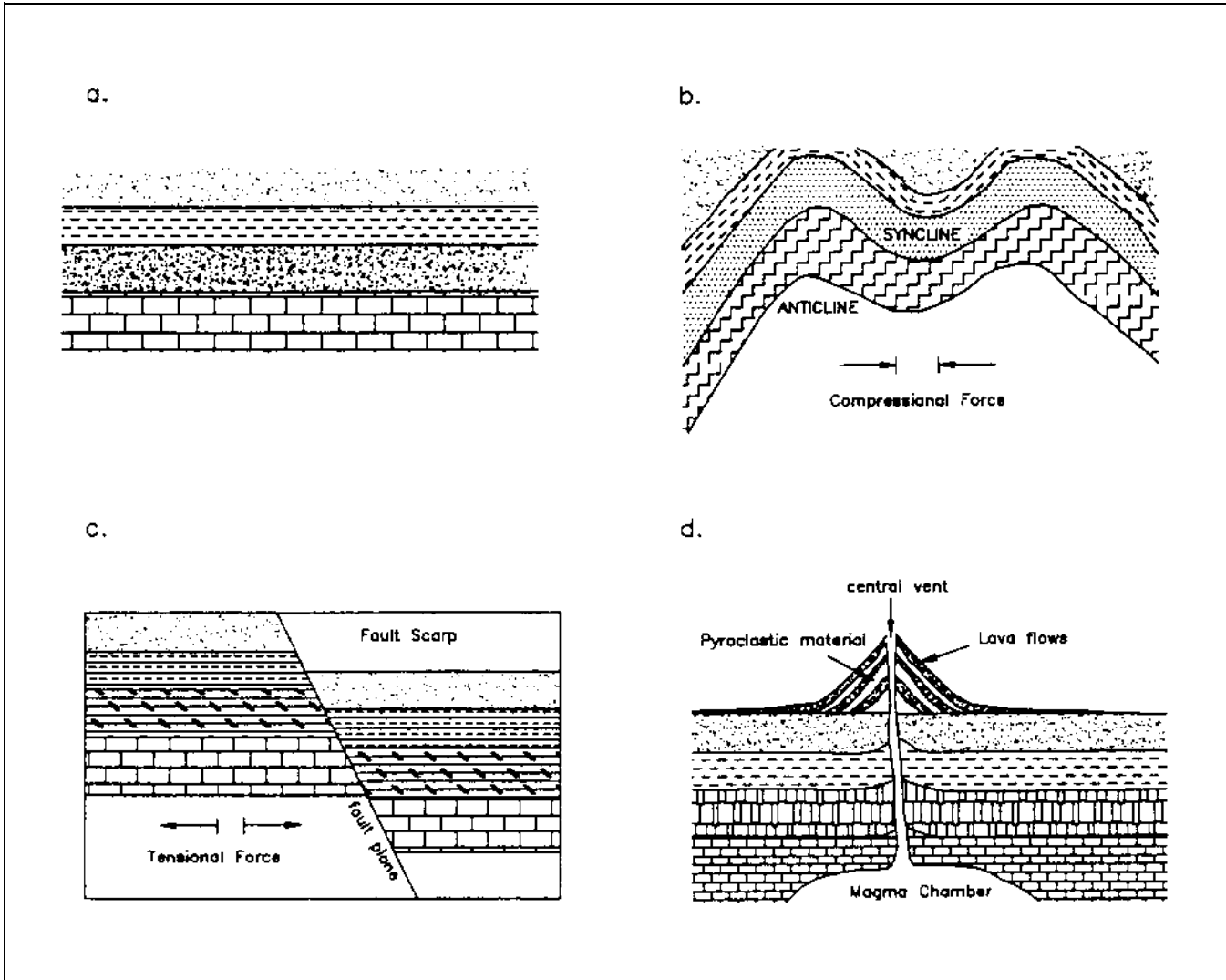

Figure 2-8. Examples of tectonically produced features: (a) stable undeformed block; (b) symmetrical folding resulting from compressional forces; (c) normal faulting resulting from tensional forces; (d) composite volcano composed of alternating layers of pyroclastic material (ash) and lava flows

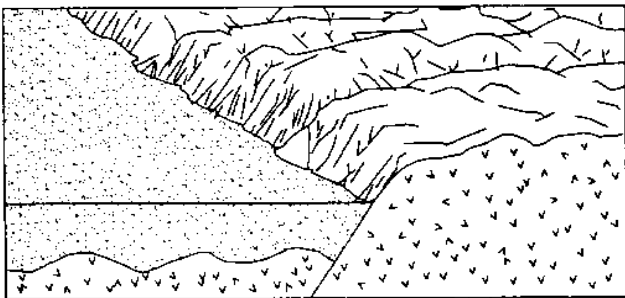

Figure 2-9. Example of a fault coast exhibiting a prominent fault scarp



Figure 2-10. Example of a volcanic coast

(1) Waves.

(a) Water waves (sometimes called *gravity waves*) are the dominant force driving littoral processes on open coasts. The following quotes from the *Shore Protection Manual* (1984) underscore the significance of waves in the coastal zone:

Waves are the major factor in determining the geometry and composition of beaches and significantly influence the planning and design of harbors, waterways, shore protection measures, coastal structures, and other coastal works. Surface waves generally derive their energy from the winds. A significant amount of this wave energy is finally dissipated in the nearshore region and on the beaches.

Waves provide an important energy source for forming beaches; sorting bottom sediments on the shoreface; transporting bottom materials onshore, offshore, and alongshore; and for causing many of the forces to which coastal structures are subjected. An adequate understanding of the fundamental physical processes in surface wave generation and propagation must precede any attempt to understand complex water motion in the nearshore areas of large bodies of water. Consequently, an understanding of the mechanics of wave motion is essential in the planning and design of coastal works.

(b) Energy in the nearshore zone occurs over a broad band of frequencies, of which gravity waves occupy the range from about 1 to 30 sec (Figure 2-11). Waves with a period shorter than 5 or 6 sec, known as seas, are usually generated by local winds; waves that have traveled out of their generating area are known as *swell*. Swell waves are more regular, and longer period and have flatter crests than local waves. Waves create currents, which move sediment both onshore and offshore as well as parallel to the coast by means of longshore currents.

(c) Wave climate generally changes seasonally, thus resulting in regular adjustment of the beach profile. Along California and other areas, the more severe wave climate of winter causes erosion of the shore. The eroded material is usually transported to the upper shoreface, where it forms submarine bars. With the return of milder conditions in the summer months, the sand usually returns to the beach (Bascom 1964).

(d) Because of space limitations, a comprehensive discussion of waves is not possible in this manual.

Bascom's (1964) *Waves and Beaches* is a readable general introduction to the subject. A concise overview of water wave mechanics is presented in EM 1110-2-1502; more detailed treatments are in Kinsman (1965), Horikawa (1988), and Le Méhauté (1976). Interpreting and applying wave and water level data are covered in EM 1110-2-1414. Quality control issues for users of wave data are discussed in Chapter 5 of this manual.

(2) Tides.

(a) The most familiar sea level changes are those produced by astronomical tides. *Tides* are a periodic rise and fall of water level caused by the gravitational interaction among the earth, moon, and sun. Because the earth is not covered by a uniform body of water, tidal ranges and periods vary from place to place and are dependent upon the natural period of oscillation for each water basin (Komar 1976). Tidal periods are characterized as diurnal (one high and one low per day), semidiurnal (two highs and two lows per day), and mixed (two highs and two lows with unequal heights) (Figure 2-12). In the coastal zone, variations in topography, depth, seafloor sediment type, and lateral boundaries also affect the tide. Tide heights can be predicted from the astronomic harmonic components. The National Ocean Survey (NOS) prints annual tide tables for the Western Hemisphere (see Appendix F for addresses of Federal agencies). Background information and theory are presented in physical oceanography textbooks (e.g., von Arx 1962; Knauss 1978). Dronkers (1964) and Godin (1972) are advanced texts on tidal analysis.

(b) The importance of tides to coastal geological processes is threefold. First, the periodic change in water level results in different parts of the foreshore being exposed to wave energy throughout the day. In regions with large tidal ranges, the water may rise and fall 10 m, and the shoreline may move laterally several kilometers between high and low water. This phenomenon is very important biologically because the ecology of tidal flats depends on their being alternately flooded and exposed. The geological significance is that various parts of the intertidal zone are exposed to erosion and deposition.

(c) Second, tidal currents themselves can erode and transport sediment. Generally, tidal currents become stronger near the coast and play an increasingly important role in local circulation (Knauss 1978). Because of the rotating nature of the tidal wave in many locations (especially inland seas and enclosed basins), ebb and flood currents follow different paths. As a result, residual motions can be highly important in terms of transport and

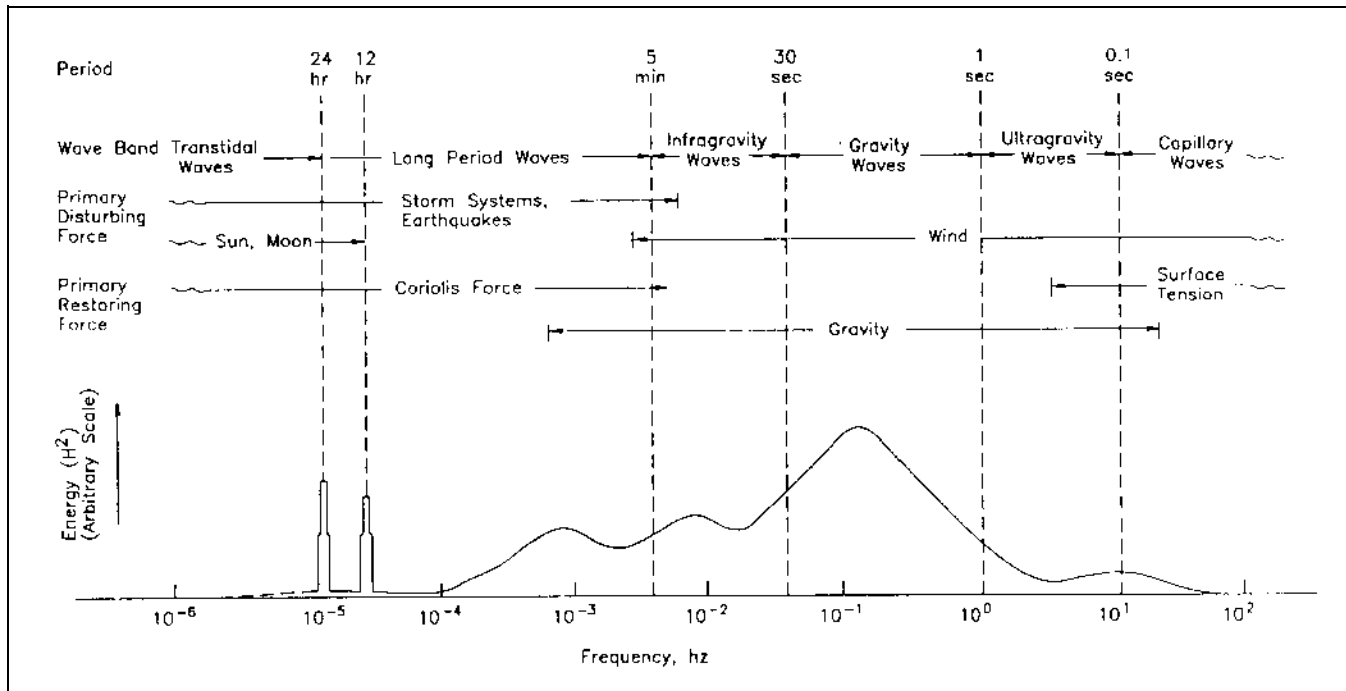

Figure 2-11. Distribution of ocean surface wave energy (after Kinsman (1965))

sedimentation (Carter 1988). In inlets and estuaries, spatially asymmetric patterns of ebb and flood may cause mass transport of both water and sediment.

(d) Third, tides cause the draining and filling of tidal bays. These bays are found even in low-tide coasts such as the Gulf of Mexico. This process is important because it is related to the cutting and migration of tidal inlets and the formation of flood- and ebb-tidal shoals in barrier coasts. The exchange of seawater in and out of tidal bays is essential to the life cycle of many marine species.

(3) Energy-based classification of shorelines.

(a) Davies (1964) applied an energy-based classification to coastal morphology by subdividing the world's shores according to tide range. Hayes (1979) expanded this classification, defining five tidal categories for coastlines:

- Microtidal, < 1 m.
- Low-mesotidal, 1-2 m.
- High-mesotidal, 2-3.5 m.
- Low-macrotidal, 3.5-5 m.

- Macrotidal, > 5 m.

The Hayes (1979) classification was based primarily on shores with low to moderate wave power and was intended to be applied to trailing edge, depositional coasts.

(b) In the attempt to incorporate wave energy as a significant factor modifying shoreline morphology, five shoreline categories were identified based on the relative influence of tide range versus mean wave height (Figure 2-13) (Nummedal and Fischer 1978; Hayes 1979; Davis and Hayes 1984):

- Tide-dominated (high).
- Tide-dominated (low).
- Mixed-energy (tide-dominated).
- Mixed energy (wave-dominated).
- Wave-dominated.

(c) The approximate limit of barrier island development is in the field labeled "mixed energy"

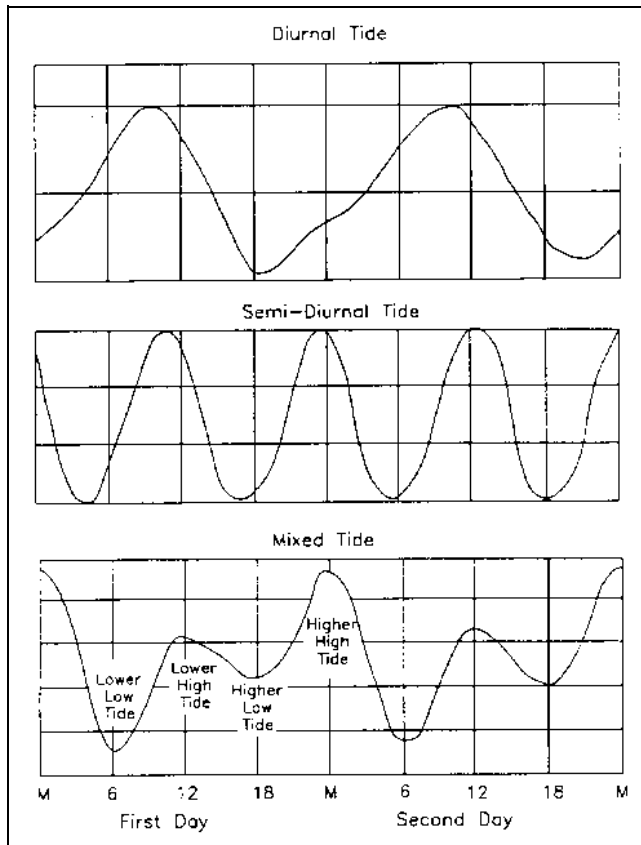

Figure 2-12. Examples of the diurnal, semidiurnal, and mixed tides

(tide-dominated).” Notice that these fields cover a range of tide and wave heights. It is the relative effects of these processes that are important, not the absolute values. Also, at the lower end of the energy scales, there is a delicate balance between the forces; tide-dominated, wave-dominated, or mixed-energy morphologies may develop with very little difference in wave or tide parameters. By extension, tidal inlets have sometimes been classified using this nomenclature.

(d) Continuing research has shown, however, that earlier approaches to classifying the coast on the basis of tidal and wave characteristics have been oversimplified because many other factors can play critical roles in determining shoreline morphology and inlet characteristics (Davis and Hayes 1984; Nummedal and Fischer 1978). Among these factors are:

- Physiographic setting and geology.
- Tidal prism.

- Sediment availability.
- Influence of riverine input.
- Bathymetry of the back-barrier bays.
- Meteorology and the influence of storm fronts.

(4) Meteorology. *Meteorology* is the study of the spatial and temporal behavior of atmospheric phenomena. *Climate* characterizes the long-term meteorologic conditions of an area, using averages and various statistics. Factors directly associated with climate such as wind, temperature, precipitation, evaporation, chemical weathering, and seawater properties all affect coastal geology. The shore is also affected by wave patterns that may be due to local winds or may have been generated by storms thousands of kilometers away. Fox and Davis (1976) is an introduction to weather patterns and coastal processes. Detailed analyses of wind fields and wave climatology have been conducted by the USACE Wave Information Studies (WIS) program (Appendix D). Hsu (1988) reviews coastal meteorology fundamentals.

(a) Wind. Wind is caused by pressure gradients, horizontal differences in pressure across an area. Wind patterns range in scale from global, which are generally persistent, to local and short duration, such as thunderstorms.

(b) Direct influence of wind. Wind has a great influence on coastline geomorphology, both directly and indirectly. The direct influence includes wind as an agent of erosion and transportation. It affects the coastal zone by eroding, transporting, and subsequently depositing sediment. Bagnold (1954) found that a proportional relationship exists between wind speed and rate of sand movement. The primary method of sediment transport by wind is through saltation, or the bouncing of sediment grains across a surface. Two coastal geomorphic features that are a direct result of wind are dunes and related blowouts (Pethick 1984). *Dunes* are depositional features whose form and size are a result of sediment type, underlying topography, wind direction, duration, and strength. *Blowouts* form when wind erodes an unvegetated area, thus removing the sand and leaving a low depression. These features are discussed in more detail in Chapter 3.

(c) Indirect effect. Wind indirectly affects coastal geomorphology as wind stress upon a water body causes the formation of waves and oceanic circulation.

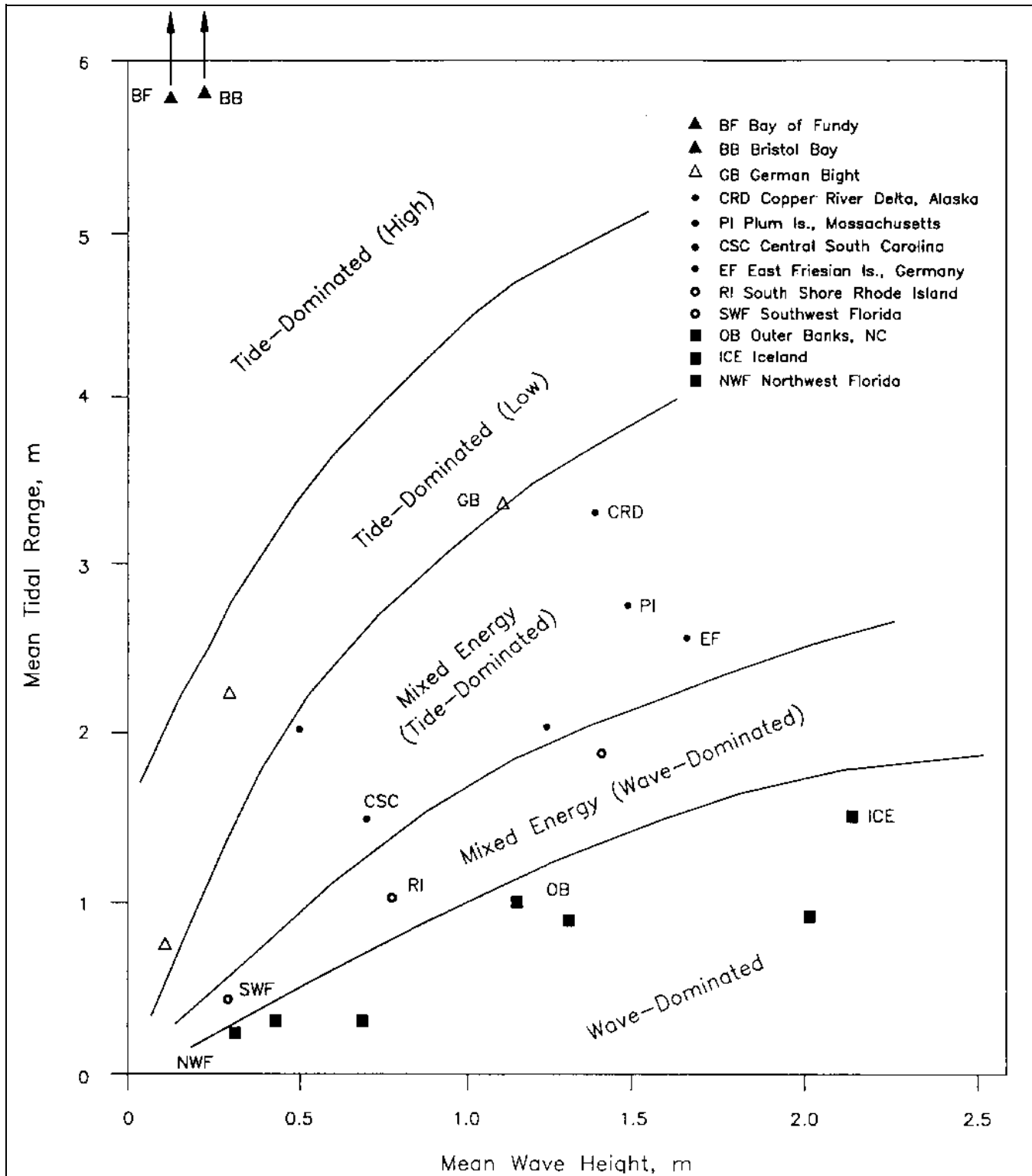

Figure 2-13. Energy-based classification of shorelines (from Hayes (1979))

(d) Land/sea breeze. Diurnal variations in the wind result from differential heating of the ocean and land surfaces. During the day, especially in summer, the heating of the land causes the air to expand and rise, thus forming an area of low pressure. The pressure gradient between the water and the land surfaces causes a landward-directed breeze. At night, the ocean cools less rapidly than does the land, thus resulting in air rising over the ocean and subsequently seaward-directed breezes. These breezes are rarely greater than 8 m/sec (15 knots) and therefore do not have a great effect upon coastline geomorphology, although there may be some offshore-onshore transport of sediment on beaches (Komar 1976).

(e) Water level setup and setdown. Onshore winds cause a landward movement of the surface layers of the water and thus a seaward movement of deeper waters. Strong onshore winds, if sustained, may also cause increased water levels or setup. The opposite occurs during offshore winds.

(f) Seiches. *Seiches* are phenomena of standing oscillation that occur in large lakes, estuaries, and small seas in response to sudden changes in barometric pressure, violent storms, and tides. This condition causes the water within the basin to oscillate much like water sloshing in a bowl.

(5) Tropical storms. A *cyclone* is a system of winds that rotates about a center of low atmospheric pressure clockwise in the Southern Hemisphere and anti-clockwise in the Northern Hemisphere (Gove 1986). *Tropical storm* is a general term for a low-pressure, synoptic-scale¹ cyclone that originates in a tropical area. At maturity, tropical cyclones are the most intense and feared storms in the world; winds exceeding 90 m/sec (175 knots or 200 mph) have been measured, accompanied by torrential rain (Huschke 1959). By convention, once winds exceed 33 m/sec (74 mph), tropical storms are known as *hurricanes* in the Atlantic and eastern Pacific, *typhoons* in the western Pacific (Philippines and China Sea), and cyclones in the Indian Ocean.

(a) Tropical storms can cause severe beach erosion and destruction of shore-front property because elevated sea level, high wind, and depressed atmospheric pressure can extend over hundreds of kilometers. Tropical storms can produce awesome property damage (Table 2-4) and move vast quantities of sediment. The great Gulf of

Mexico hurricane of 1900 inundated Galveston Island, killing 6,000 residents (NOAA 1977). The hurricane that devastated Long Island and New England in September of 1938 killed 600 people and eliminated beach-front communities along the southern Rhode Island shore (Minsinger 1988). Survivors reported 50-ft breakers sweeping over the Rhode Island barriers (Allen 1976). Hurricane Hugo hit the U.S. mainland near Charleston, SC, on September 21, 1989, causing over \$4 billion in damage, eroding the barriers, and producing other geologic changes up to 180 km north and 50 km south of Charleston (Davidson, Dean, and Edge 1990; Finkl and Pilkey 1991). Simpson and Riehl (1981) have examined the effects of hurricanes in the United States. This work and Neumann et al. (1987) list landfall probabilities for the United States coastline. Tropical storms from 1871 to 1986 are plotted in Neumann et al. (1987). Tannehill (1956) identified all known Western Hemisphere hurricanes before the 1950's. Representative tropical storm tracks are shown in Figure 2-14.

(b) The Saffir-Simpson Scale has been used for over 20 years by the U.S. National Weather Service to compare the intensity of tropical cyclones (Table 2-5). Cyclones are ranked into five categories based on maximum wind speed.

(c) During tropical storms and other weather disturbances, water level changes are caused by two factors:

- *Barometric pressure.* Barometric pressure has an inverse relationship to sea level. As atmospheric pressure increases, the sea surface is depressed so that the net pressure on the seafloor remains constant. Inversely, as atmospheric pressure decreases, surface water rises. The magnitude of the "inverse barometer effect" is about 0.01 m for every millibar of difference in pressure, and in areas affected by tropical storms or hurricanes, the potential barometric surge may be as high as 1.5 m (Carter 1988).

- *Storm surges.* In shallow water, winds can pile up water against the shore or drive it offshore. Storm surges, caused by a combination of low barometric pressure and high onshore winds, can raise sea level several meters, flooding coastal property. The Federal Emergency Management Agency (FEMA) determines base flood elevations for the coastal counties of the United States. These elevations include still-water-level flood surges that have a 100-year return interval. In light of rising sea level along most of the United States, it seems prudent that Flood Insurance Rate Maps be periodically adjusted (National Research Council 1987). Besides wind forcing,

¹ Synoptic-scale refers to large-scale weather systems as distinguished from local patterns such as thunderstorms.

Table 2-4
Biggest Payouts by Insurance Companies for U.S. Catastrophes

Date	Event (Region of Greatest Influence)	Insured loss (millions) ¹
Aug. 1992	Hurricane Andrew (Florida, Louisiana) ²	\$16,500
Sep. 1989	Hurricane Hugo (S. Carolina)	4,195
March 1993	Winter storms (24 states; coastal California)	1,750
Oct. 1991	Oakland, CA, fire	1,700
Sep. 1992	Hurricane Iniki (Hawaiian Is.)	1,600
Oct. 1989	Loma Prieta, CA, earthquake	960
Dec. 1983	Winter storms, 41 states	880
April-May 1992	Los Angeles riots	775
April 1992	Wind, hail, tornadoes, floods (Texas and Oklahoma)	760
Sep. 1979	Hurricane Frederic (Mississippi, Alabama)	753
Sep. 1938	Great New England Hurricane (Long Island, Rhode Island, Connecticut, Massachusetts)	400 ³

Notes:

1. Total damage costs exceed insurance values because municipal structures like roads are not insured.
2. Andrew caused vast property damage in south central Florida, proving that hurricanes are not merely coastal hazards.
3. Multiplying the 1938 damage value by 4 or 5 gives a crude estimate in 1990's Dollars (Data source: Minsinger 1988).

(Source: *The New York Times*, December 28, 1993, citing insurance industry and State of Florida sources)

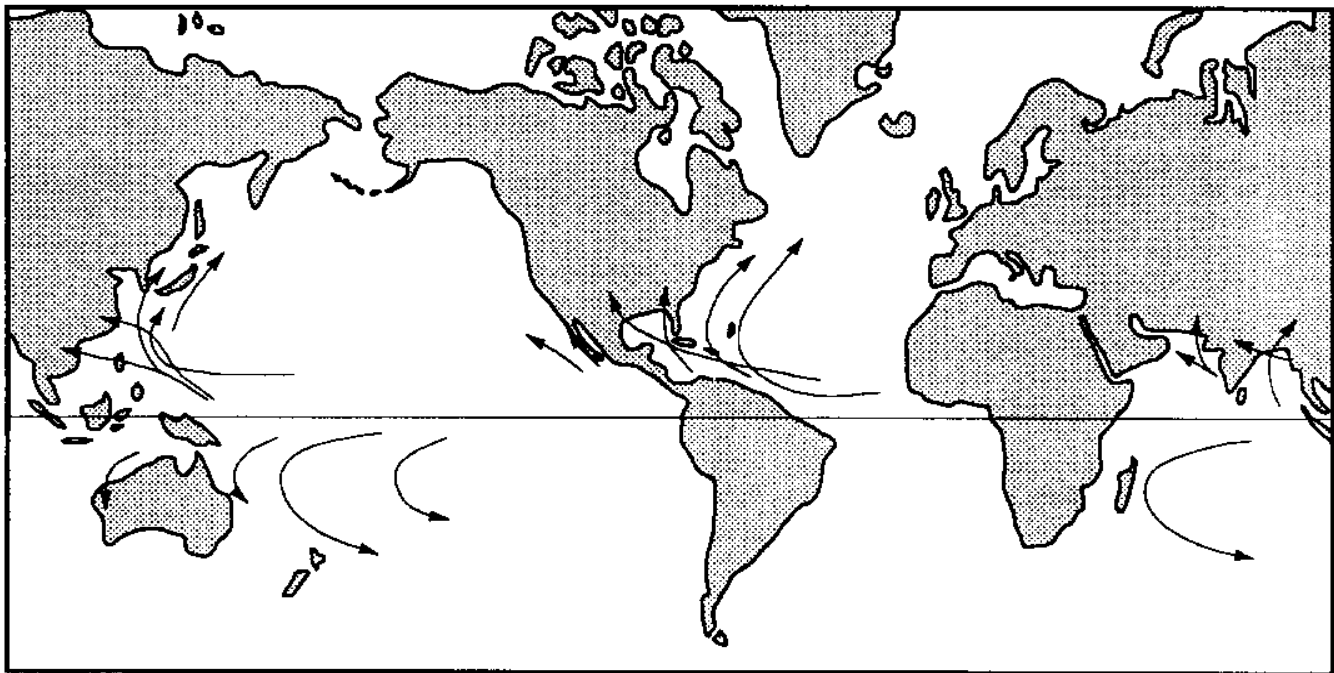

Figure 2-14. Worldwide tropical storm pathways (from Cole (1980))

Table 2-5
Saffir-Simpson Damage-Potential Scale

Scale Number (category)	Central pressure (millibars)	Wind speed (miles/hr)	Wind speed (m/sec)	Surge (ft)	Surge (m)	Damage
1	≥980	74-95	33-42	4-5	~1.5	Minimal
2	965-979	96-110	43-49	6-8	~2-2.5	Moderate
3	945-964	111-130	50-58	9-12	~2.6-3.9	Extensive
4	920-944	131-155	59-69	13-18	~4-5.5	Extreme
5	<920	>155	>69	>18	>5.5	Catastrophic

(From Hsu (1988); originally from Simpson and Riehl (1981))

ocean waves generated by storms can temporarily increase water levels tens of centimeters. Analysis procedures for predicting surge heights are detailed in EM 1110-2-1412.

(6) Extratropical storms. *Extratropical cyclones* (ET's) are cyclones associated with migratory fronts occurring in the middle and high latitudes (Hsu 1988). Although hurricanes are the most destructive storms to pass over the U.S. Atlantic coast, less powerful ET's, more commonly known as winter storms or "northeasters," have also damaged ships, eroded beaches, and taken lives. Northeasters are not as clearly defined as hurricanes and their wind speeds seldom approach hurricane strength. On the other hand, ET's usually cover broader areas than hurricanes and move more slowly; therefore, ET's can generate wave heights that exceed those produced by tropical storms (Dolan and Davis 1992).

(a) Most Atlantic northeasters occur from December through April. Dolan and Davis (1992) have tabulated historic ET's and calculated that the most severe ones are likely to strike the northeast coast in October and January.

(b) The *Halloween Storm* of October 1991 was one of the most destructive northeasters to ever strike the Atlantic coast. The system's lowest pressure dipped to 972 mb on October 30. Sustained winds about 40-60 knots persisted for 48 hr, generating immense seas and storm surges (Dolan and Davis 1992). Another famous northeaster was the *Ash Wednesday Storm* of 1962, which claimed 33 lives and caused great property damage.

(c) In early 1983, southern California was buffeted by the most severe storms in 100 years, which devastated coastal buildings and caused tremendous erosion. During

one storm in January 1983, which coincided with a very high tide, the cliffs in San Diego County retreated as much as 5 m (Kuhn and Shepard 1984). Further north, the storm was more intense and cliff retreat of almost 30 m occurred in places. Kuhn and Shepard (1984) speculated that the unusual weather was linked to the eruption of El Chichon Volcano in the Yucatan Peninsula in March 1982. They noted that the 1983 storms in California were the most intense since the storms of 1884, which followed the August 27, 1883, explosion of Krakatoa.

(d) At this time, weather forecasters still have difficulty forecasting the development and severity of ET's. Coastal planners and engineers must anticipate that powerful storms may lash their project areas and need to apply conservative engineering and prudent development practices to limit death and property destruction.

c. *Biological factors.*

Coastal areas are normally the sites of intense biological activity. This is of enormous geological importance in some areas, while being insignificant and short-lived in others. Biological activity can be constructive; e.g., the growth of massive coral reefs, or it can be destructive, as when boring organisms help undermine sea cliffs. Remains from marine organisms having hard skeletal parts, usually composed of calcium carbonate, contribute to the sediment supply almost everywhere in the coastal environment. These skeletal contributions can be locally important and may even be the dominant source of sediment. Vegetation, such as mangroves and various grasses, plays an important role in trapping and stabilizing sediments. Growth of aquatic plants in wetlands and estuaries is critical in trapping fine-grained sediments, eventually leading to infilling of these basins (if balances between sediment supply and sea level changes remain

steady). Kelp, particularly the larger species, can be an important agent of erosion and transportation of coarse detritus such as gravel and cobble. Biological coasts are discussed in greater detail in Chapter 3. Deltaic and estuarine processes, which are greatly influenced by biology, are discussed in Chapter 4.

2-6. Sea Level Changes

a. Background.

(1) General.

(a) Changes in sea level can have profound influence on the geology, natural ecology, and human habitation of coastal areas. A long-term and progressive rise in sea level has been cited as a major cause of erosion and property damage along our coastlines. Predicting and understanding this rise can guide coastal planners in developing rational plans for coastal development and the design, construction, and operation of structures and waterways.

(b) Many geomorphic features on contemporary coasts are the byproducts of the eustatic rise in sea level caused by Holocene climatic warming and melting of continental glaciers. Sea level has fluctuated throughout geologic time as the volume of ocean water has fluctuated, the shape of the ocean basins has changed, and continental masses have broken apart and re-formed.

(c) Sea level changes are the subject of active research in the scientific community and the petroleum industry. The poor worldwide distribution of tide gauges has hampered the study of recent changes (covering the past century) as most gauges were (and still are) distributed along the coasts of industrial nations in the Northern Hemisphere. Readers interested in this fascinating subject are referred to Emery and Aubrey's (1991) excellent book, *Sea Levels, Land Levels, and Tide Gauges*. This volume and Gorman (1991) contain extensive bibliographies. Tabular data and analyses of United States tide stations are printed in Lyles, Hickman, and Debaugh (1988), and worldwide Holocene sea level changes are documented in Pirazzoli (1991). Papers on sea level fluctuations and their effects on coastal evolution are presented in Nummedal, Pilkey, and Howard (1987). Engineering implications are reviewed in National Research Council (1987). Atmospheric CO₂, climate change, and sea level are explored in National Research Council (1983). Houston (1993) discusses the state of uncertainty surrounding predictions on sea level change.

(2) Definitions. Because of the complexity of this topic, it is necessary to introduce the concepts of relative and eustatic sea level:

(a) *Eustatic* sea level change is caused by change in the relative volumes of the world's ocean basins and the total amount of ocean water (Sahagian and Holland 1991). It can be measured by recording the movement in sea surface elevation compared with some universally adopted reference frame. This is a challenging problem because eustatic measurements must be obtained from the use of a reference frame that is sensitive *only* to ocean water and ocean basin volumes. For example, highly tectonic areas (west coasts of North and South America; northern Mediterranean countries) are not suitable for eustatic sea level research because of frequent vertical earth movements (Mariolakos 1990). Tide gauge records from "stable" regions throughout the world have generated estimates of the recent eustatic rise ranging from 15 cm/century (Hicks 1978) to 23 cm/century (Barnett 1984).

(b) A *relative* change in water level is, by definition, a change in the elevation of the sea surface compared with some local land surface. The land, the sea, or both may have moved in *absolute* terms with respect to the earth's geoid. It is exceptionally difficult to detect absolute sea level changes because tide stations are located on land masses that have themselves moved vertically. For example, if both land and sea are rising at the same rate, a gauge will show that relative sea level (rsl) has not changed. Other clues, such as beach ridges or exposed beach terraces, also merely reflect their movement relative to the sea.

(3) Overview of causes of sea level change.

(a) Short-term sea level changes are caused by seasonal and other periodic or semi-periodic oceanographic factors. These include astronomical tides, movements of ocean currents, runoff, melting ice, and regional atmospheric variations. Included in this category are abrupt land level changes that result from volcanic activity or earthquakes. *Short-term* is defined here as an interval during which we can directly see or measure the normal level of the ocean rising or falling (a generation or 25 years). These factors are of particular pertinence to coastal managers and engineers, who are typically concerned with projects expected to last a few decades and who need to anticipate sea level fluctuations in their planning.

(b) Slow, secular sea and land level changes, covering time spans of thousands or millions of years, have been caused by glacioeustatic, tectonic, sedimentologic, climatologic, and oceanographic factors. Sea level was about 100 to 130 m lower during the last glacial epoch (Figure 2-15), about 15,000 years before present. Ancient shorelines and deltas can be found at such depths along the edge of the continental shelf (Suter and Berryhill 1985). Changes of this magnitude have been recorded during other geological epochs (Payton 1977).

(c) Table 2-6 lists long-term and short-term factors along with estimates of their effect on sea level. The following paragraphs discuss some factors in greater detail.

b. Short-term causes of sea level change.

(1) Seasonal sea level changes.

(a) The most common of the short-term variations is the seasonal cycle, which in most areas accounts for water level changes of 10 to 30 cm (and in some unusual cases - the Bay of Bengal - as much as 100 cm) (Komar and Enfield 1987). Seasonal effects are most noticeable near river mouths and estuaries. Variations in seasonal river flow may account for up to 21 percent of annual sea level variations in coastal waters (Meade and Emery 1971). Compared to the eustatic rise of sea level, estimated to be up to 20 cm/century, the seasonal factor may be a more important cause of coastal erosion because of

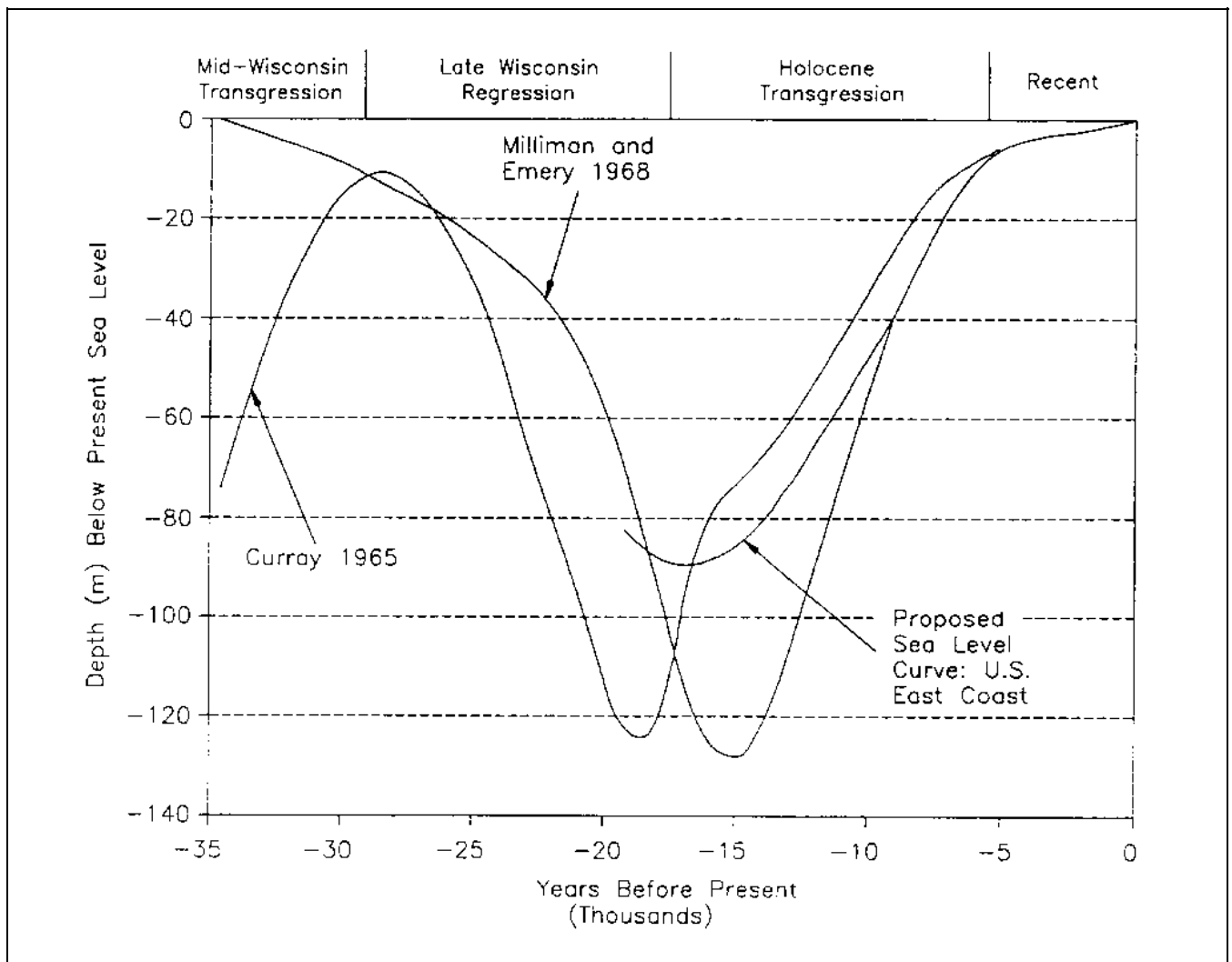

Figure 2-15. Sea level fluctuations during the Pleistocene and Holocene epochs (adapted from Nummedal (1983); data from Dillon and Oldale (1978))

Table 2-6
Sea Level Changes Along the Coastal Zone

Short-Term (Periodic) Causes	Time scale (P = period)	Vertical Effect ¹
Periodic Sea Level Changes		
Astronomical tides	6-12 hr P	0.2-10+ m
Long-period tides		
Rotational variations (Chandler effect)	14 month P	
Meteorological and Oceanographic Fluctuations		
Atmospheric pressure		
Winds (storm surges)	1-5 days	Up to 5 m
Evaporation and precipitation	Days to weeks	
Ocean surface topography (changes in water density and currents)	Days to weeks	Up to 1 m
El Niño/southern oscillation	6 mo every 5-10 yr	Up to 60 cm
Seasonal Variations		
Seasonal water balance between oceans (Atlantic, Pacific, Indian)		
Seasonal variations in slope of water surface		
River runoff/floods	2 months	1 m
Seasonal water density changes (temperature and salinity)	6 months	0.2 m
Seiches		
	Minutes-hours	Up to 2 m
Earthquakes		
Tsunamis (generate catastrophic long-period waves)	Hours	Up to 10 m
Abrupt change in land level	Minutes	Up to 10 m
Long-Term Causes		
Change in Volume of Ocean Basins		
Plate tectonics and seafloor spreading (plate divergence/convergence) and change in seafloor elevation (mid-ocean volcanism)	E	0.01 mm/yr
Marine sedimentation	E	< 0.01 mm/yr
Change in Mass of Ocean Water		
Melting or accumulation of continental ice	E	10 mm/yr
Release of water from earth's interior	E	
Release or accumulation of continental hydrologic reservoirs	E	
Uplift or Subsidence of Earth's Surface (Isostasy)		
Thermal-isostasy (temperature/density changes in earth's interior)	L	
Glacio-isostasy (loading or unloading of ice)	L	1 cm/yr
Hydro-isostasy (loading or unloading of water)	L	
Volcano-isostasy (magmatic extrusions)	L	
Sediment-isostasy (deposition and erosion of sediments)	L	< 4 mm/yr
Tectonic Uplift/Subsidence		
Vertical and horizontal motions of crust (in response to fault motions)	L	1-3 mm/yr
Sediment Compaction		
Sediment compression into denser matrix	L	
Loss of interstitial fluids (withdrawal of oil or groundwater)	L	
Earthquake-induced vibration	L	
Departure from Geoid		
Shifts in hydrosphere, aesthenosphere, core-mantle interface	L	
Shifts in earth's rotation, axis of spin, and precession of equinox	E	
External gravitational changes	E	

¹Effects on sea level are estimates only. Many processes interact or occur simultaneously, and it is not possible to isolate the precise contribution to sea level of each factor. Estimates are not available for some factors. (Sources: Emery and Aubrey (1991); Gornitz and Lebedeff (1987); Komar and Enfield (1987))

its greater year-to-year influence (Komar and Enfield 1987).

(b) Over most of the world, lowest sea level occurs in spring and highest in autumn. Separating the individual factors causing the annual cycle is difficult because most of the driving mechanisms are coherent - occurring in phase with one another. Variations in atmospheric pressure drive most of the annual sea level change (Komar and Enfield 1987).

(2) West coast of North America.

(a) The west coast is subject to extreme and complicated water level variations. Short-term fluctuations are related to oceanographic conditions like the El Niño-Southern Oscillation. This phenomenon occurs periodically when equatorial trade winds in the southern Pacific diminish, causing a seiching effect that travels eastward as a wave of warm water. This raises water levels all along the U.S. west coast. Normally, the effect is only a few centimeters, but during the 1982-83 event, sea level rose 35 cm at Newport, OR (Komar 1992). Although these factors do not necessarily cause permanent geologic changes, engineers and coastal planners must consider their potential effects.

(b) Seasonal winter storms along the Pacific Northwest can combine with astronomical tides to produce elevated water levels over 3.6 m. During the severe storms of 1983, water levels were 60 cm over the predicted level.

(3) Rapid land level changes. Earthquakes are shock waves caused by abrupt movements of blocks of the earth's crust. A notable example occurred during the Great Alaskan Earthquake of 1964, when changes in shoreline elevations ranged from a 10-m uplift to a 2-m downdrop (Hicks 1972; Plafker and Kachadoorian 1966).

(4) Ocean temperature. Changes in the water temperature of upper ocean layers cause changes in water density and volume. As surface water cools, the density of seawater increases, causing a decrease in volume, thus lowering sea level. When temperature increases, the opposite reaction occurs. Variations in water temperature are not simply due to seasonal changes in solar radiation but are primarily caused by changes in offshore wind and current patterns.

(5) Ocean currents. Because of changes in water density across currents, there is a slope of the ocean surface occurring at right angles to the direction of current flow. The result is an increase in height on the right side

of the current (when viewed in the direction of flow) in the Northern Hemisphere and to the left in the Southern Hemisphere. The elevation change across the Gulf Stream, for example, exceeds 1 m (Emery and Aubrey 1991). In addition, major currents in coastal areas can produce upwelling, a process that causes deep colder water to move upward, replacing warmer surface waters. The colder upwelled water is denser, resulting in a regional decrease in sea level.

c. Long-term causes of sea level change.

(1) Tectonic instability. Regional, slow land level changes along the U.S. western continental margin affect relative long-term sea level changes. Parts of the coast are rising and falling at different rates. In Oregon, the northern coast is falling while the southern part is rising relative to concurrent relative sea level (Komar 1992).

(2) Isostasy. *Isostatic adjustment* is the process by which the crust of the Earth attains gravitational equilibrium with respect to superimposed forces (Emery and Aubrey 1991). If a gravitational imbalance occurs, the crust rises or sinks to correct the imbalance.

(a) The most widespread geologically rapid isostatic adjustment is the depression of land masses caused by glaciers and the rebounding caused by deglaciation. In Alaska and Scandinavia, contemporary uplift follows the depression of the crust caused by the Pleistocene ice sheets. Some areas of the Alaska coast (for example, Juneau) are rising over 1 cm/year, based on tide gauge records (Figure 2-16) (Lyles, Hickman, and Debaugh 1988).

(b) Isostatic adjustments have also occurred due to changes in sediment load on continental shelves and at deltas. The amount of sediment loading on shelves is not well determined but is probably about 4 mm/yr. The effect is only likely to be important at deltas where the sedimentation rate is very high (Emery and Aubrey 1991).

(3) Sediment compaction.

(a) Compaction occurs when poorly packed sediments reorient into a more dense matrix. Compaction can occur because of vertical loading from other sediments, by draining of fluids from the sediment pore space (usually a man-made effect), by desiccation (drying), and by vibration.

(b) Groundwater and hydrocarbon withdrawal is probably the main cause of sediment compaction on a

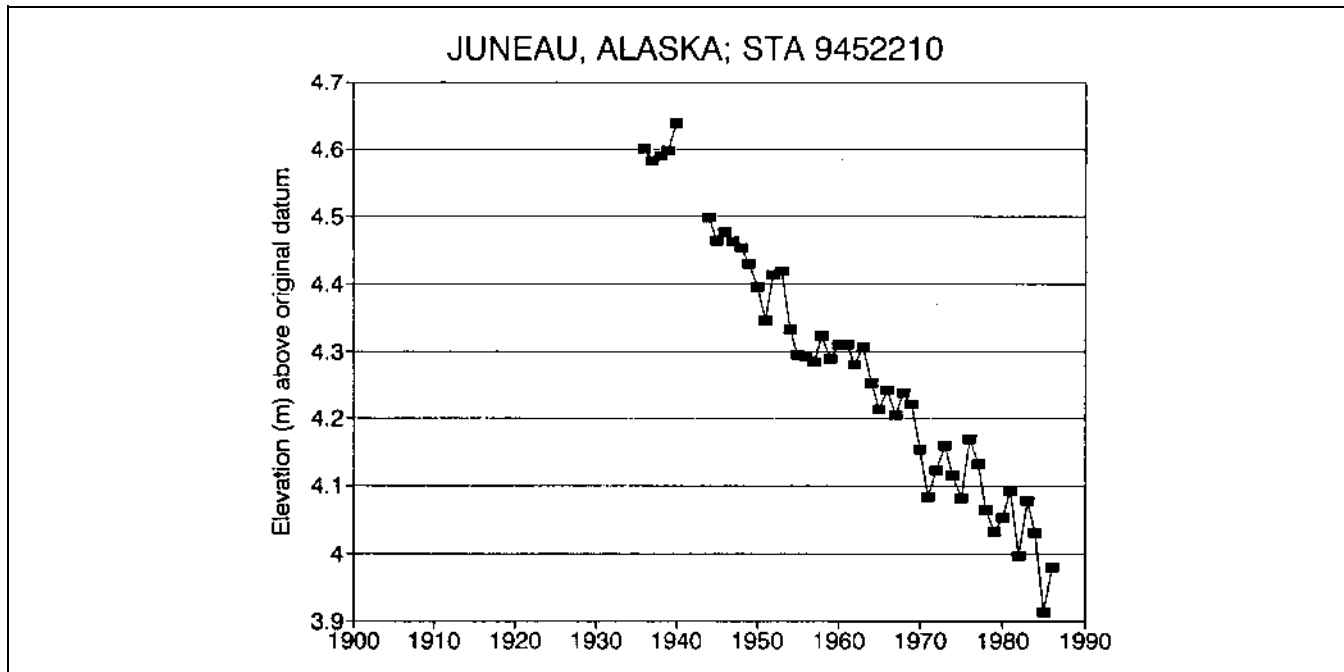

Figure 2-16. Yearly mean sea level changes at Juneau, Alaska, from 1936-1986. The fall in sea level shows the effects of isostatic rebound (data from Lyles, Hickman, and Debaugh (1988))

regional scale. Subsidence exceeding 8 m has been recorded in Long Beach, CA, and over 20 m in the Houston-Freeport area (Emery and Aubrey 1991). In Galveston, the annual sea level rise shown on tide records is 0.6 cm/yr (Figure 2-17) (Lyles, Hickman, and Debaugh 1988). Subsidence at Venice, Italy, caused by groundwater pumping, has been well-publicized because of the threat to architectural and art treasures. Fortunately, subsidence there appears to have stopped now that alternate sources of water are being tapped for industrial and urban use (Emery and Aubrey 1991).

(c) Significant subsidence occurs in and near deltas, where great masses of fine-grained sediment accumulate rapidly. Land loss in the Mississippi delta has become a critical issue in recent years because of the loss of wetlands and rapid shoreline retreat. Along with natural compaction of underconsolidated deltaic muds and silts, groundwater and hydrocarbon withdrawal and river diversion might be factors contributing to the subsidence problems experienced in southern Louisiana. Tide gauges at Eugene Island and Bayou Rigaud show that the rate of subsidence has increased since 1960 (Emery and Aubrey 1991). Change in rsl in the Mississippi Delta is about 15 mm/yr, while the rate at New Orleans is almost 20 mm/yr (data cited in Frihy (1992)).

d. *Geologic implications of sea level change.*

(1) Balance of sediment supply versus sea level change. Changes in sea level will have different effects on various portions of the world's coastlines, depending on conditions such as sediment type, sediment supply, coastal planform, and regional tectonics. The shoreline position in any one locale responds to the cumulative effects of the various sea level effects (outlined in Table 2-6). For simplicity, these factors can be subdivided into two broad categories: sediment supply and rsl change. Ultimately, shoreline position is a balance between sediment availability and the rate that sea level changes (Table 2-7). For example, at an abandoned distributary of the Mississippi River delta, rsl is rising rapidly because of compaction of deltaic sediment. Simultaneously, wave action causes rapid erosion. The net result is extra rapid shoreline retreat (the upper right box in Table 2-7). The examples in the table are broad generalizations, and some sites may not fit the model because of unique local conditions.

(2) Historical trends. Historical records show the prevalence of shore recession around the United States

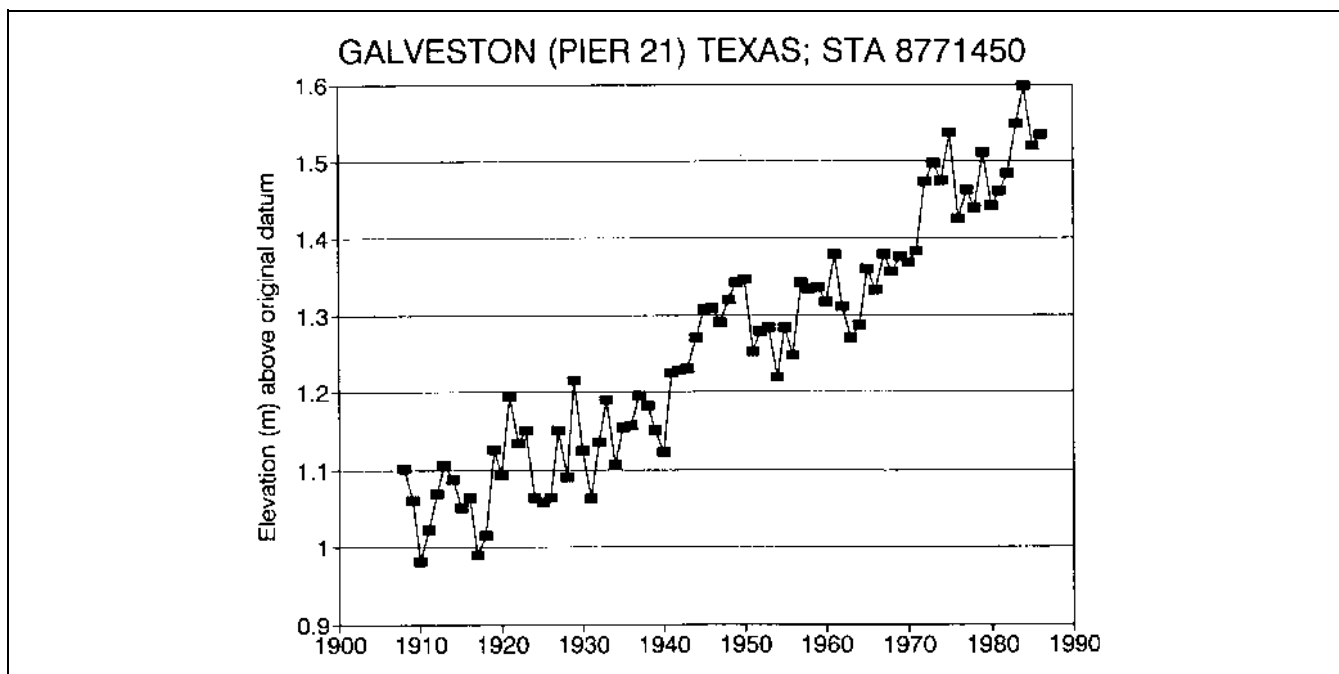

Figure 2-17. Yearly mean sea level changes at Galveston, Texas, from 1908-1986. Subsidence of the land around Galveston may be caused by groundwater withdrawal and sediment compaction (data from Lyles, Hickman, and Debaugh (1988))

during the past century (summarized by the National Research Council (1987):

- National average (unweighted) erosion rate: 0.4 m/yr.
- Atlantic Coast: 0.8 m/yr (with Virginia barrier islands exhibiting the highest erosion rates).
- Gulf Coast: 1.8 m/yr (with highest erosion rate in Louisiana, 4.2 m/yr).
- Pacific coastline: essentially stable (although more than half the shore is hard rock).

Bird (1976) claims that most sandy shorelines around the world have retreated during the past century. Prograding shores occur in areas where rivers supply excess sediment or where tectonic uplift is in progress.

(3) Specific coastal sites.

(a) Sandy (barrier) coasts. Several models predicting the effects of sea level rise on sandy coasts have been proposed. One commonly cited model is the Bruun rule. The Bruun rule and barrier migration models are discussed in Chapter 3, paragraph 3-9.

(b) Cliff retreat. Cliff retreat is a significant problem in the Great Lakes, along the Pacific coast, and in parts of New England and New York. Increases in water level are likely to accelerate the erosion rate along Great Lakes shores (as shown by Hands (1983) for eastern Lake Michigan). However, along southern California, cliff retreat may be episodic, caused by unusually severe winter storms, groundwater and surface runoff, and, possibly, faulting and earthquakes, factors not particularly influenced by sea level (Kuhn and Shepard 1984). Crystalline cliffs are essentially stable because their response time is so much slower than that of sandy shores. Mechanisms of cliff erosion are discussed in Chapter 3, paragraph 3-8.

(c) Marshes and wetlands. Marshes and mangrove forests fringe or back most of the Gulf and Atlantic coastlines. Marshes have the unique ability to grow upward in response to rising sea level. However, although marshes produce organic sediment, at high rates of rsl rise, additional sediment from outside sources is necessary to allow the marshes to keep pace with the rising sea. Salt marshes are described in detail in Chapter 3, paragraph 3-11. Paragraph 3-12 describes wetlands, coral and oyster reefs, and mangrove forest coasts. These shores have the natural ability to adjust to changing sea level as long as they are not damaged by man-made factors like urban runoff or major changes in sediment supply.

Table 2-7
Relative Effects of Sediment Supply Versus Sea Level Change on Shoreline Position

		Relative Sea Level Change				
		Falling sea level		Stable	Rising sea level	
		Rapid	Slow		Slow	Rapid
Sediment supply	Rapid net loss	Neutral	Slow retreat	Medium retreat	Rapid retreat ⁴	Extra rapid retreat ²
	Slow net loss	Slow advance	Neutral	Slow retreat	Medium retreat ⁶	Rapid retreat
	Zero net change	Medium advance	Slow advance	Neutral ⁸	Slow retreat	Medium retreat
	Low net deposition	Rapid advance	Medium advance ¹⁰	Slow advance ⁷	Neutral ^{3,5}	Slow retreat
	Rapid net deposition	Extra rapid advance	Rapid advance ⁹	Medium advance	Slow advance ¹	Neutral

Examples of long-term (years) transgression or regression:

1. Mississippi River Delta - active distributary
2. Mississippi River Delta - abandoned distributary
3. Florida Panhandle between Pensacola and Panama City
4. Sargent Beach, TX
5. Field Research Facility, Duck, NC
6. New Jersey shore
7. Island of Hawaii - volcanic and coral sediment supply
8. Hawaiian Islands without presently active volcanoes
9. Alaska river mouths
10. Great Lakes during sustained fall in water levels

(Table based on a figure in Curray (1964))

e. Engineering and social implications of sea level change.

(1) Eustatic sea level rise.

(a) Before engineering and management can be considered, a fundamental question must be asked: Is sea level still rising? During the last decade, the media has “discovered” global warming, and many politicians and members of the public are convinced that greenhouse gases are responsible for rising sea level and the increased frequency of flooding that occurs along the coast during storms. The Environmental Protection Agency created a sensation in 1983 when it published a report linking atmospheric CO₂ to a predicted sea level rise of between 0.6

and 3.5 m (Hoffman, Keyes, and Titus 1983). Since then, predictions of the eustatic rise have been falling, and some recent evidence suggests that the rate may slow or even that eustatic sea level may drop in the future (Houston 1993).

(b) Possibly more reliable information on Holocene sea level changes can be derived from archaeological sites, wave-cut terraces, or organic material. For example, Stone and Morgan (1993) calculated an average rise of 2.4 mm/year from radiocarbon-dated peat samples from Santa Rosa Island, on the tectonically stable Florida Gulf coast. However, Tanner (1989) states that difficulties arise using all of these methods, and that calculated dates and rates may not be directly comparable.

(c) Based on an exhaustive study of tide records from around the world, Emery and Aubrey (1991) have concluded that it is not possible to assess if a *eustatic* rise is continuing because, while many gauges do record a recent rise in *relative* sea level, an equal number record a fall. Emery and Aubrey state (p. ix):

In essence, we have concluded that 'noise' in the records produced by tectonic movements and both meteorological and oceanographic factors so obscures any signal of eustatic rise of sea level that the tide gauge records are more useful for learning about plate tectonics than about effects of the greenhouse heating of the atmosphere, glaciers, and ocean water.

They also state (p. 176):

This conclusion should be no surprise to geologists, but it may be unexpected by those climatologists and laymen who have been biased too strongly by the public's perception of the greenhouse effect on the environment...Most coastal instability can be attributed to tectonism and documented human activities without invoking the spectre of greenhouse-warming climate or collapse of continental ice sheets.

(d) In summary, despite the research and attention devoted to the topic, the evidence about worldwide, eustatic sea level rise is inconclusive. Estimates of the rate of rise range from 0 to 3 mm/year, but some researchers maintain that it is not possible to discover a statistically reliable rate using tide gauge records. In late Holocene time, sea level history was much more complicated than has generally been supposed (Tanner 1989), suggesting that there are many perturbations superimposed on "average" sea level curves. Regardless, the topic is sure to remain highly controversial.

(2) Relative sea level (rsl) changes.

(a) The National Research Council's Committee on Engineering Implications of Changes in Relative Sea Level (National Research Council 1987) examined the evidence on sea level changes. They concluded that rsl, on statistical average, is rising at most tide gauge stations located on continental coasts around the world. In their executive summary, they concluded (p. 123):

The risk of accelerated mean sea level rise is sufficiently established to warrant consideration in the planning and design of coastal facilities. Although

there is substantial local variability and statistical uncertainty, average relative sea level over the past century appears to have risen about 30 cm relative to the East Coast of the United States and 11 cm along the West Coast, excluding Alaska, where glacial rebound has resulted in a lowering of relative sea level. Rates of relative sea level rise along the Gulf coast are highly variable, ranging from a high of more than 100 cm/century in parts of the Mississippi delta plain to a low of less than 20 cm/century along Florida's west coast.

However, they, too, noted the impact of management practices:

Accelerated sea level rise would clearly contribute toward a tendency for exacerbated beach erosion. However, in some areas, anthropogenic effects, particularly in the form of poor sand management practices at channel entrances, constructed or modified for navigational purposes, have resulted in augmented erosion rates that are clearly much greater than would naturally occur. Thus, for some years into the future, sea level rise may play a secondary role in these areas.

(b) Figure 2-18 is a summary of estimates of local rsl changes along the U.S. coast (National Research Council 1987). Users of this map are cautioned that the figures are based on tide records only from 1940-1980 and that much regional variability is evident. The figure provides general information only; for project use, detailed data should be consulted, such as the tide gauge statistics printed in Lyles, Hickman and Debaugh (1988) (examples from two tide stations are plotted in Figures 2-16 and 2-17).

(3) Engineering response and policy.

(a) Whatever the academic arguments about eustatic sea level, engineers and planners must anticipate that changes in rsl may occur in their project areas and need to incorporate the anticipated changes in their designs and management plans.

(b) Because of the uncertainties surrounding sea level, USACE has not endorsed a particular rise (or fall) scenario. Engineer Regulation ER 1105-2-100 (28 December 1990) states the official USACE policy on sea level rise. It directs that:

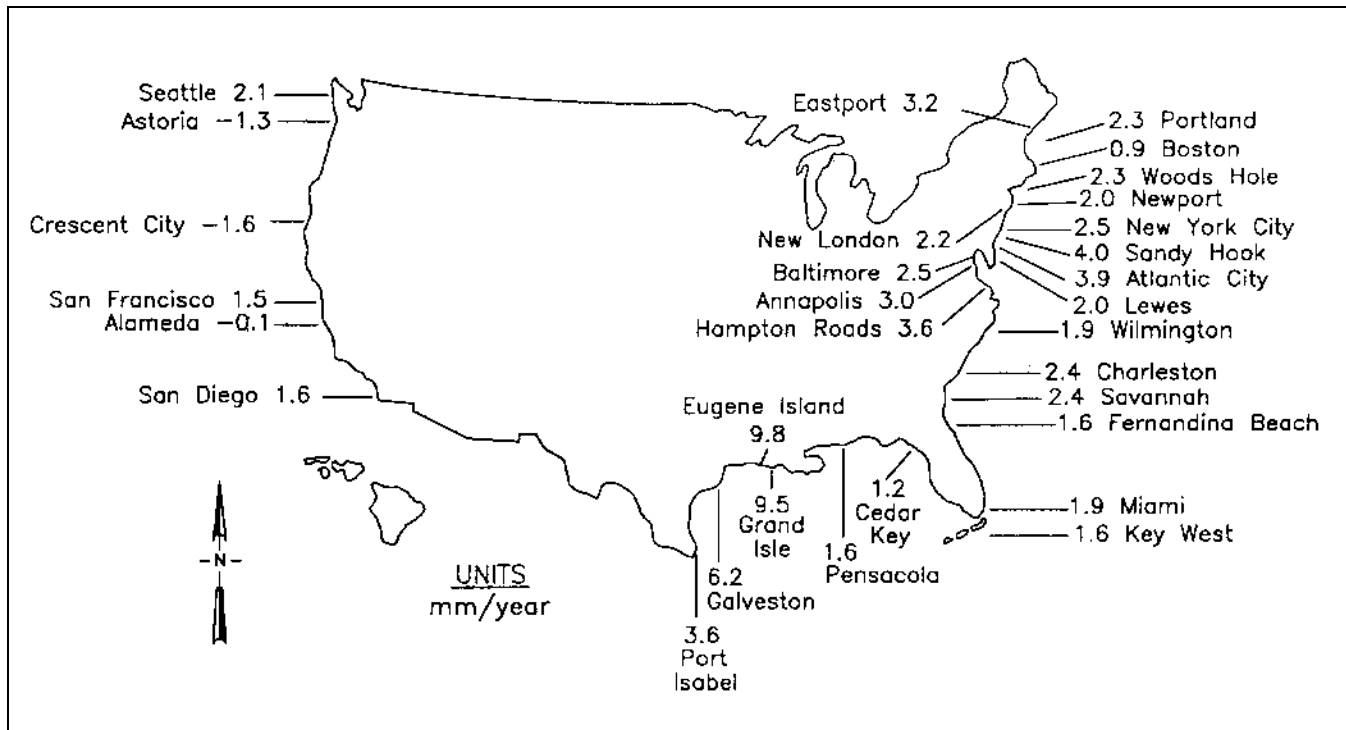

Figure 2-18. Summary of estimates of local rsl rise along the continental United States in millimeters per year. Values are based on tide gauge records during the period 1940-1980 (from National Research Council (1987))

Feasibility studies should consider which designs are most appropriate for a range of possible future rates of rise. Strategies that would be appropriate for the entire range of uncertainty should receive preference over those that would be optimal for a particular rate of rise but unsuccessful for other possible outcomes.

Potential rsl rise should be considered in every coastal and estuarine (as far inland as the new head of tide) feasibility study that USACE undertakes. Project planning should consider what impact a higher rsl rise would have on designs based on local, historical rates.

(3) Impacts of rising sea level on human populations.

(a) Rising sea level raises the spectre of inundated cities, lost wetlands, and expensive reconstruction of waterways and ports. About 50 percent of the U.S. population lives in coastal counties (1980 census data reported in Emery and Aubrey (1991)), and the number is likely to increase. There has not been a long history of understanding and planning for sea level rise in the United States, but other countries, particularly Holland and China, have coped with the problem for thousands of

years (National Research Council 1987). There are three principal ways that people could adapt to rising sea level:

- Retreat and abandonment.
- Erecting dikes and dams to keep out the sea.
- Construction on landfills and piers.

(b) Among the areas most susceptible to inundation caused by rise in rsl are deltas. Deltas are naturally sinking accumulations of sediment whose subaerial surface is a low-profile, marshy plain. Already, under present conditions, subsidence imposes especially severe hardships on the inhabitants in coastal Bangladesh (10 mm/yr) and the Nile Delta (2 mm/yr), two of the most densely populated regions on earth (Emery and Aubrey 1991). Even a slow rise in sea level could have devastating effects. How could these areas be protected? Thousands of kilometers of seawalls would be needed to protect a broad area like coastal Bangladesh from the sea and from freshwater rivers. Civil works projects on this scale seem unlikely, suggesting that retreat will be the only recourse (National Research Council 1983). Nevertheless, despite the immense cost of large-scale coastal

works, the Netherlands has reclaimed from the sea a large acreage of land, which is now used for towns and agriculture.

(c) Retreat can be either a gradual (planned or unplanned) process, or a catastrophic abandonment (National Research Council 1987). The latter has occurred in communities where buildings were not allowed to be rebuilt after they were destroyed or damaged by storms. The State of Texas followed this approach on Galveston Island after Hurricane Alicia in 1983 and the State of Rhode Island for south shore communities after the Great Hurricane of 1938. Construction setback lines represent a form of controlled retreat. Seaward of setback lines, new construction is prohibited. City managers and coastal planners often have difficulty in deciding where setback lines should be located, and their decisions are usually contested by property developers who wish to build as close to the beach as possible.

(d) Most of the world's coastal cities are subject to inundation with even a modest rise of sea level. Irresistible political pressure will surely develop to defend cities against the rising sea because of the high concentration of valuable real estate and capital assets. Defense will most probably take the form of dikes like the ones that protect large portions of Holland and areas near Tokyo and Osaka, Japan, from flooding. Dikes would be needed to protect low-lying inland cities from rivers whose lower courses would rise at the same rate as the sea. Already, New Orleans (which is below sea level), Rotterdam, and other major cities located near river mouths are kept dry by protective levees. These levees might have to be raised under the scenario of rising sea level. Storm surge barriers, like the ones at New Bedford, MA, Providence, RI, and the Thames, below London, England, might have to be rebuilt to maintain an adequate factor of safety.

(e) Landfilling has historically been a common practice, and many coastal cities are partly built on landfill. Boston's waterfront, including the airport and the Back Bay, is built on 1800's fill (Figure 2-19). Large areas around New York City, including parts of Manhattan and Brooklyn, have been filled since the 1600's (Leveson 1980). In the early 1700's, Peter the Great built his monumental new capital of Saint Petersburg on pilings and fill in the estuary of the Neva River. Artificial land, which is usually low, is particularly susceptible to rising sea level. Although dikes and levees will probably be the most common means to protect cities threatened by the rising sea, there is a U.S. precedent for raising the level of the land surface where structures already exist: Seattle's

downtown was raised about 3 m in the early 1900's to prevent tidal flooding. The elevated streets ran along the second floor of buildings, and the original sidewalks and store fronts remained one floor down at the bottom of open troughs. Eventually, the open sidewalks had to be covered or filled because too many pedestrians and horses were injured in falls.

f. Changes in sea level - summary.

(1) Changes in sea level are caused by numerous physical processes, including tectonic forces that affect land levels and seasonal oceanographic factors that influence water levels on various cycles (Table 2-5). Individual contributions of many of these factors are still unknown.

(2) Estimates of the eustatic rise in sea level range from 0 to 3 mm/year. Emery and Aubrey (1991) have strongly concluded that it is not possible to detect a statistically verifiable rate of eustatic sea level rise because of noise in the signals and because of the poor distribution of tide gauges worldwide.

(3) Arguments regarding eustatic sea level changes may be more academic than they are pertinent to specific projects. The rate of *relative* sea level change varies greatly around the United States. Coastal planners need to consult local tide gauge records to evaluate the potential movement of sea level in their project areas.

(4) In many areas, coastal management practices have the greatest influence on erosion, and sea level changes are a secondary effect (Emery and Aubrey 1991; National Research Council 1987).

(5) The USACE does not endorse a particular sea level rise (or fall) scenario. Engineer Regulation ER 1105-2-100 (28 December 1990) directs that feasibility studies must consider a range of possible future rates of sea level rise. Project planning should use local, historical rates of rsl change.

2-7. Cultural (Man-Made) Influences on Coastal Geology

a. Introduction. Man has modified many of the world's coastlines, either directly, by construction or dredging, or indirectly, as a result of environmental changes that influence sediment supply, runoff, or climate. Human activity has had the most profound effects on the coastal environment in the United States and the other

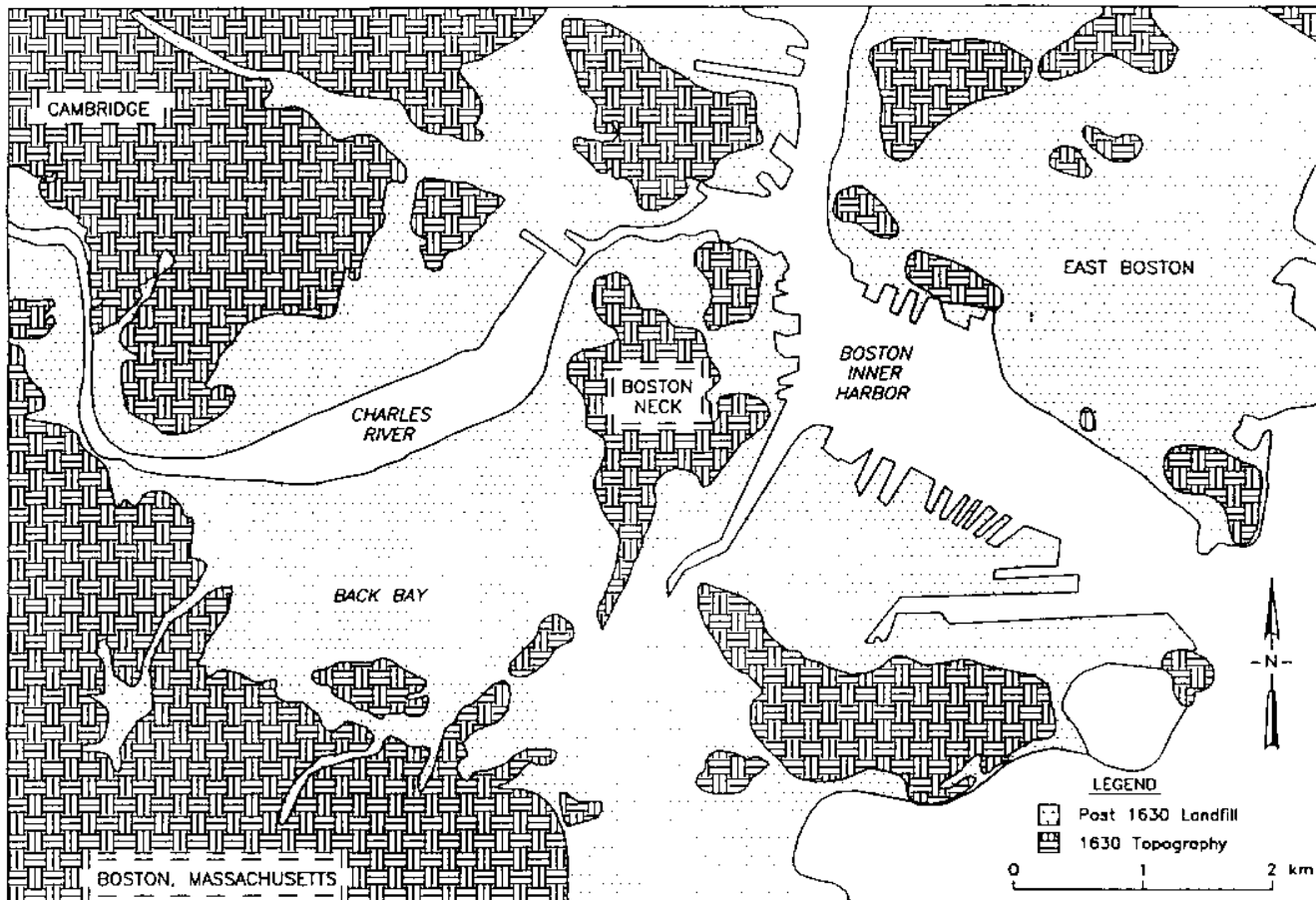

Figure 2-19. Landfilling in Boston, MA, since 1630 has more than doubled the urban area (unfortunately, at the expense of destroying what must have been highly productive wetlands) (from Rosen, Brenninkmeyer, and Maybury 1993)

industrial nations, but even shorelines in lesser-developed, agricultural countries have not been immune to problems wrought by river diversion and loss of wetlands. The most common practices that significantly alter the coastal environment are the construction of coastal works such as jetties and groins and the development of property on and immediately inland of the beach. Historically, many cities have developed on the coast. Although originally most were located in bays or other protected anchorages, many have grown and spread to the open coast. Prominent examples include New York, Boston, San Diego, and Los Angeles. Still other communities originally began as resorts on barrier islands and have since grown into full-size cities; examples include Atlantic City, Ocean City, Virginia Beach, and Miami Beach. Land use practices well inland from the coast also often have important effects on coastal sedimentation. These factors are more difficult to detect and analyze because, sometimes, the affecting region is hundreds of kilometers inland. For example, dam construction can greatly reduce the natural

supply of sediment brought to the coast by streams and rivers, while deforestation and agricultural runoff may lead to increased sediment load in rivers.

b. Dams/Reservoirs. In many coastal areas, the major source of sediment for the littoral system is from streams and rivers (*Shore Protection Manual* 1984). Dams and reservoirs obstruct the transport of sediment to the littoral system by creating sediment traps. These structures also restrict peak flows, which reduce sediment transport of material that is available downstream of the structures. The net effect is sediment starvation of coastal areas that normally receive riverine sediment. If the losses are not offset by new supplies, the results are shrinking beaches and coastal erosion (Schwartz 1982). The most prominent example is the accelerated erosion of the Nile Delta since the Aswan Low Dam (1902) and the Aswan High Dam (1964) almost totally blocked the supply of sediment to the coast (Frihy 1992). The Rosetta promontory has been eroding at an average rate of

55 m/yr between 1909 and the present. Loss of nutrient-laden silt from the Nile's annual spring floods has also had bad effects on agriculture in the Nile valley and delta and has damaged fisheries in the eastern Mediterranean. Portions of the southern California coast have also suffered this century from loss of fluvially supplied sediment (e.g., Point Arguello, cited by Bowen and Inman (1966)).

c. *Erosion control and coastal structures.* Coastal structures such as jetties, groins, seawalls, bulkheads, and revetments are probably the most dramatic cause of man-induced coastal erosion (*Shore Protection Manual* 1984). Structures are broadly subdivided into several general classes:

- Seawalls and bulkheads intended to prevent erosion along cliffs and slopes.
- Groins built perpendicular to the coast to trap littoral drift.
- Breakwaters designed to protect inlets and harbors.

The following paragraphs briefly discuss coastal geologic effects caused by these structures.

(1) Seawalls, bulkheads, and revetments. These structures have traditionally been placed along a threatened stretch of coastline to prevent erosion or reduce undercutting of cliffs. Seawalls cause a range of environmental problems. Because they are static features, they are unable to respond to dynamic beach changes and typically impede land-sea sediment interchange (Carter 1988). On the beach (seaward) side of seawalls, wave reflection tends to transport material seaward, and it is common for the beach to drop in level over time. Examples of United States seawalls where the formerly protective beaches have eroded include Revere, MA, and Galveston, TX. Problems may also occur on the landward side of seawalls if drainage of groundwater is not adequate. Increased pore pressure may lead to instability and cliff failure (Kuhn and Shepard 1984). Critical erosion problems can occur near the ends of seawalls if they are not properly tied in to the adjacent shoreline. Waves erode the unprotected shore, eventually causing an embayment to form. With time, the embayment grows, enveloping the end of the seawall and exposing the formerly protected backshore to erosion. A spectacular example of the "terminal scour" problem is at Cape May, New Jersey, where erosion has caused shoreline retreat of over 1 km and resulted in the destruction of the village of South Cape May (Carter 1988).

(2) Shore-normal structures - jetties and groins.

(a) *Groins* are usually installed to prevent or reduce the rate of erosion along a particular stretch of the shore. Their purpose is to interrupt the longshore transport of littoral material, trapping sediment that would naturally move downdrift. Unfortunately, groins typically accomplish little to cure the root causes of the erosion problem in a particular area (i.e., a lack of sediment, often made worse by updrift groin fields). Terminal groins have proven useful in stabilizing shores in specific locations, such as at inlets or the ends of littoral cells. There are many environmental disadvantages to groins, the most obvious being sediment starvation downdrift. Unfortunately, many local communities have fallen prey to exaggerated claims of the efficacy of groins in solving their erosion problems.

(b) *Jetties* are structures, generally built perpendicular to the shore, designed to direct and confine tidal or riverine flow to a selected channel to prevent or reduce shoaling of that channel. Jetties also protect inlets and harbor mouths from storm waves. There are hundreds of navigation projects in the United States protected by jetties. Jetties often cause or contribute to local geologic effects (which may not occur at all sites):

- Jetties often interrupt littoral drift, allowing sediment to accumulate updrift and causing sand starvation downdrift.
- Inlet mouths are stabilized, preventing migration.
- Tidal prisms may change because of the presence of the permanent and maintained channel. This can affect salinity, flushing, and nutrient and larval exchanges between the sea and the bay.
- Sediment flow in and out of tidal inlets may be interrupted, leading to sediment starvation in some cases and excessive shoaling in others.
- Ebb-tidal shoal growth is often enhanced after jetty construction and stabilization of the channel mouth.

Some of these effects are not caused solely by the jetties but are also a result of dredging, ship traffic, and other aspects of a maintained navigation channel. Inlets are discussed in greater detail in Chapter 4, paragraph 4-4. Design of breakwaters and jetties is covered in EM 1110-2-2904.

d. *Modification of natural protection.*

(1) Destructive effects. The destruction of dunes and beach vegetation, development of backshore areas, and construction on the back sides of barrier islands can increase the occurrence of overwash during storms. In many places, sand supply has diminished because much of the surface area of barriers has been paved or covered with buildings. The result has been backshore erosion and increased breaching of barrier islands. In most coastal areas of the United States, one need merely visit the local beaches to see examples of gross and callous coastal development where natural protection has been compromised. Carter (1988) reviews examples from the United Kingdom. Serious damage has occurred to biological shores around the world as a result of changes in runoff and sediment supply, increased pollution, and development.

(2) Constructive efforts. Sand dunes are often stabilized using vegetation and sand fences. Dunes afford protection against flooding of low-lying areas. Dunes are also stabilized to prevent sand from blowing over roads and farms. Dunes are discussed in Chapter 3, paragraph 3-6.

e. *Beach renourishment.* An alternative for restoring beaches without constructing groins or other hard structures is to bring sand to the site from offshore by dredges or from inland sources by truck. Although conceptually renourishment seems simple enough, in practice, the planning, design, application, and maintenance of beach renourishment projects are sophisticated engineering and geologic procedures. Beach fill design is not covered in this manual. For design and monitoring information, the reader is referred to the *Shore Protection Manual* (1984), Tait (1993), and Stauble and Kraus (1993). *Shore and Beach*, Vol 61, No. 1 (January 1993) is a special issue devoted to the beach renourishment project at Ocean City, MD. Stauble et al. (1993) evaluate the Ocean City project in detail. Krumbein (1957) is a classic description of sediment analysis procedures for specifying beach fills. One of the most successful U.S. renourishment projects has been at Miami Beach, FL (reviewed in Carter (1988)).

f. *Mining.*

(1) Beach mining can directly reduce the amount of sediment available to the littoral system. In many areas of the United States, beach sand can no longer be exploited for commercial purposes because sand is in short supply on many shores, and the health of dunes and biological communities depends vitally on the availability

of sand. Strip mining can indirectly affect the coast due to increased erosion, which increases sediment carried to the sea by rivers (unless the sediment is trapped behind dams).

(2) In Britain, an unusual situation developed at Horden, County Durham, where colliery waste was dumped on the shore. The waste material formed a depositional bulge in the shore. As the sediment from Horden moves downcoast, it has been sorted, with the less dense coal forming a surface placer on the beach that is commercially valuable (Carter 1988).

g. *Stream diversion.*

(1) Stream diversion, both natural and man-made, disrupts the natural sediment supply to areas that normally receive fluvial material. With diversion for agriculture or urban use, the results are similar to those produced by dams: sediment that normally would be carried to the coast remains trapped upriver. Its residence time in this artificial storage, decades or centuries, may be short on geological time scales but is long enough to leave a delta exposed to significant erosion.

(2) Natural diversion occurs when a river shifts to a new, shorter channel to the sea, abandoning its less-efficient former channel. An example of this process is the gradual occupation of the Atchafalaya watershed by the Mississippi River. If this process were to continue to its natural conclusion, the present Balize ("Birdfoot") delta would be abandoned, causing it to erode at an ever faster rate, while a new delta would form in Atchafalaya Bay (Coleman 1988). The evolution of the Mississippi River is discussed in Chapter 4, paragraph 4-3.

h. *Agriculture.* Poor farming practices lead to exposure of farmlands and increased erosion rates. Eroded soil is easily carried away by streams and rivers and is ultimately deposited in estuaries and offshore. The consequence of this process is accretion and progradation of the depositional areas.

i. *Forestry.* Deforestation is a critical problem in many developing nations, where mountainsides, stripped of their protective trees, erode rapidly. The soil is carried to the sea, where local coastlines prograde temporarily, but upland areas are left bereft of invaluable topsoil, resulting in human poverty and misery and in the loss of animal habitat. Reckless slash-and-burn practices have destroyed many formerly valuable timber resources in Central America, and some southeast Asian countries have already cut down most of these trees (Pennant-Rea

1994). Fortunately, Malaysia and Indonesia are beginning to curb illegal timber cutting and export, a trend which hopefully will spread to other countries.

Chapter 3 Coastal Classification and Morphology

3-1. Introduction

a. Since ancient times, men have gone to sea in a variety of vessels to obtain food and to transport cargo and passengers to distant ports. In order to navigate safely, sailors needed an intimate knowledge of the appearance of the coast from place to place. By the time that systematic study of coastal geology and geomorphology began, there already existed a large body of observational knowledge about seacoasts in many parts of the world and a well-developed nomenclature to portray coastal landforms. Geologists in the 19th and 20th centuries described coastal landforms, examined their origin and development as a function of geologic character, history, and dynamic processes, and devised classification schemes to organize and refine their observations.

b. The first part of this chapter discusses the coastal classification of Francis Shepard (1973). The second part describes specific coastal environments found around the United States following Shepard's outline.

3-2. Coastal Classification

By its very nature, the shoreline is an incredibly complex and diverse environment, one that may defy organization into neat compartments. Nevertheless, the quest for understanding how shorelines have formed and how human activities affect these processes has demanded that classification schemes be devised. Most attempts have grouped coastal areas into identifiable classes that have similar features as a result of having developed in similar geological, environmental, and historic settings.

a. Early classifications. Many early geologists took a genetic approach to classification and distinguished whether the coast had been primarily affected by rising sea level (submergence), falling sea level (emergence), or both (compound coasts) (Dana 1849; Davis 1896; Gulliver 1899; Johnson 1919; Suess 1888).

b. Later classifications. The best known of the modern classifications are those of Cotton (1952), Inman and Nordstrom (1971), Shepard (1937), with revisions in 1948, 1971 (with Harold Wanless), 1973, and 1976, and Valentin (1952). Except for Inman and Nordstrom (1971), the classifications emphasized onshore and shoreline morphology but did not include conditions of the offshore bottom. This may be a major omission because

the submarine shoreface and the shelf are part of the coastal zone. Surprisingly few attempts have been made to classify the continental shelf. Shepard (1948; 1977) and King (1972) discussed continental shelf types, but their classifications are not detailed and contain only a few broadly defined types.

c. Coastal classification of Francis Shepard. Possibly the most widely used coastal classification scheme is the one introduced by Shepard in 1937 and modified in later years. It divides the world's coasts into primary coasts - formed mostly by non-marine agents - and secondary coasts - shaped primarily by marine processes. Further subdivisions occur according to which specific agent, terrestrial or marine, had the greatest influence on coastal development. The advantage of Shepard's classification is that it is more detailed than others, allowing most of the world's coasts to be incorporated. Although gradational shore types exist, which are difficult to classify, most coasts show only one dominant influence as the cause of their major characteristics (Shepard 1973). Because of its overall usefulness, Shepard's 1973 classification is reproduced in Table 3-1. Specific coasts are discussed in detail in this manual, approximately following the outline of Shepard's table.

d. Classification schemes for specific environments.

(1) River systems. Coleman and Wright (1971) developed a detailed classification for rivers and deltas.

(2) Great Lakes of North America. The Great Lakes have a number of unique characteristics that set them apart from oceanic coastlines. One of the most comprehensive attempts to include these factors in a classification scheme was developed by Herdendorf (1988). It was applied to the Canadian lakes by Bowes (1989). A simpler scheme has been used by the International Joint Commission as a basis for studies of shoreline erosion (Stewart and Pope 1992).

3-3. Drowned River Coasts - Estuaries*

a. Introduction. An enormous amount of technical literature is devoted to the chemistry and biology of estuaries. In recent years, much research has been devoted to estuarine pollution and the resulting damage to fish and animal habitat. For example, the famous oyster harvesting in Chesapeake Bay has been almost ruined in

* Material in this section has been condensed from Dalrymple, Zaitlin, and Boyd (1992).

Table 3-1
Classification of Coasts (Continued)

Excerpt from SUBMARINE GEOLOGY, 3rd ed. by Francis P. Shepard. Copyright 1948, 1963, 1973 by Francis P. Shepard. Reprinted by permission of Harper Collins Publishers.	Paragraph No.
1. <i>Primary coasts</i> Configuration due to nonmarine processes.	
a <i>Land erosion coasts</i> Shaped by subaerial erosion and partly drowned by postglacial rise of sea level (with or without crustal sinking) or inundated by melting of an ice mass from a coastal valley.	
(1) <i>Ria coasts (drowned river valleys)</i> Usually recognized by the relatively shallow water of the estuaries which indent the land. Commonly have V-shaped cross section and a deepening of the axis seaward except where a barrier has built across the estuary mouth.	3-3
(a) <i>Dendritic</i> Pattern resembling an oak leaf due to river erosion in horizontal beds or homogeneous material.	
(b) <i>Trellis</i> Due to river erosion in inclined beds of unequal hardness.	
(2) <i>Drowned glacial erosion coasts</i> Recognized by being deeply indented with many islands. Charts show deep water (commonly more than 100 m) with a U-shaped cross section of the bays and with much greater depth in the inner bays than near the entrance. Hanging valleys and sides usually parallel and relatively straight, in contrast to the sinuous rias. Almost all glaciated coasts have bays with these characteristics.	3-4
(a) <i>Fjord coasts</i> Comparatively narrow inlets cutting through mountainous coasts.	
(b) <i>Glacial troughs</i> Broad indentations, like Cabot Strait and the Gulf of St. Lawrence or the Strait of Juan de Fuca.	
(3) <i>Drowned karst topography</i> Embayments with oval-shaped depressions indicative of drowned sinkholes. This uncommon type occurs locally, as along the west side of Florida north of Tarpon Springs, the east side of the Adriatic, and along the Asturias coast of North Spain.	
b <i>Subaerial deposition coasts</i>	4-3
(1) <i>River deposition coasts</i> Largely due to deposition by rivers extending the shoreline since the slowing of the postglacial sea level rise.	
(a) <i>Deltaic coasts</i>	
(i) <i>Digitate (birdfoot)</i> , the lower Mississippi Delta.	
(ii) <i>Lobate</i> , western Mississippi Delta, Rhone Delta.	
(iii) <i>Arcuate</i> , Nile Delta.	
(iv) <i>Cuspate</i> , Tiber Delta.	
(v) <i>Partly drowned deltas</i> with remnant natural levees forming islands.	
(b) <i>Compound delta coasts</i> Where a series of deltas have built forward a large segment of the coast, for example, the North Slope of Alaska extending east of Point Barrow to the Mackenzie.	
(c) <i>Compound alluvial fan coasts straightened by wave erosion</i> .	
(2) <i>Glacial deposition coasts</i>	
(a) <i>Partially submerged moraines</i> Usually difficult to recognize without a field study to indicate the glacial origin of the sediments constituting the coastal area. Usually modified by marine erosion and deposition as, for example, Long Island.	
(b) <i>Partially submerged drumlins</i> Recognized on topographic maps by the elliptical contours on land and islands with oval shorelines, for example, Boston Harbor and West Ireland (Guilcher 1965).	
(c) <i>Partially submerged drift features</i>	
(3) <i>Wind deposition coasts</i> It is usually difficult to ascertain if a coast has actually been built forward by wind deposition, but many coasts consist of dunes with only a narrow bordering sand beach.	3-6
(a) <i>Dune prograded coasts</i> Where the steep lee slope of the dune has transgressed over the beach.	
(b) <i>Dune coasts</i> Where dunes are bordered by a beach.	
(c) <i>Fossil dune coasts</i> Where consolidated dunes (eolianites) form coastal cliffs.	
(4) <i>Landslide coasts</i> Recognized by the bulging earth masses at the coast and the landslide topography on land.	
c <i>Volcanic coasts</i>	
(1) <i>Lava-flow coasts</i> Recognized on charts either by land contours showing cones, by convexities of shoreline, or by conical slopes continuing from land out under the water. Slopes of 10° to 30° common above and below sea level. Found on many oceanic islands.	3-7
(2) <i>Tephra coasts</i> Where the volcanic products are fragmental. Roughly convex but much more quickly modified by wave erosion than are lava-flow coasts.	
(3) <i>Volcanic collapse or explosion coasts</i> Recognized in aerial photos and on charts by the concavities in the sides of volcanoes.	

Table 3-1 (Concluded)	Paragraph No.
<p>D. <i>Shaped by diastrophic movements</i></p> <ol style="list-style-type: none"> 1. <i>Fault coasts</i> Recognized on charts by the continuation of relatively straight steep land slopes beneath the sea. Angular breaks at top and bottom of slope. <ol style="list-style-type: none"> (a) <i>Fault scarp coasts</i> For example, northeast side of San Clemente Island, California. (b) <i>Fault trough or rift coasts</i> For example, Gulf of California and Red Sea, both being interpreted as rifts. (c) <i>Overthrust</i> No examples recognized but probably exist. 2. <i>Fold coasts</i> Difficult to recognize on maps or charts but probably exist. 3. <i>Sedimentary extrusions</i> <ol style="list-style-type: none"> (a) <i>Salt domes</i> Infrequently emerge as oval-shaped islands. Example: in the Persian Gulf. (b) <i>Mud lumps</i> Small islands due to upthrust of mud in the vicinity of the passes of the Mississippi Delta. <p>E. <i>Ice coasts</i> Various types of glaciers form extensive coasts, especially in Antarctica.</p> <p>II. <i>Secondary coasts</i> Shaped primarily by marine agents or by marine organisms. May or may not have been primary coasts before being shaped by the sea.</p> <p>A. <i>Wave erosion coasts</i></p>	3-8
<ol style="list-style-type: none"> 1. <i>Wave-straightened cliffs</i> Bordered by a gently inclined seafloor, in contrast to the steep inclines off fault coasts. <ol style="list-style-type: none"> (a) <i>Cut in homogeneous materials.</i> (b) <i>Hogback strike coasts</i> Where hard layers of folded rocks have a strike roughly parallel to the coast so that erosion forms a straight shoreline. (c) <i>Fault-line coasts</i> Where an old eroded fault brings a hard layer to the surface, allowing wave erosion to remove the soft material from one side, leaving a straight coast. (d) <i>Elevated wave-cut bench coasts</i> Where the cliff and wave-cut bench have been somewhat elevated by recent diastrophism above the level of present-day wave erosion. (e) <i>Depressed wave-cut bench coasts</i> Where the wave-cut bench has been somewhat depressed by recent diastrophism so that it is largely below wave action and the wave-cut cliff plunges below sea level. 2. <i>Made irregular by wave erosion</i> Unlike ria coasts in that the embayments do not extend deeply into the land. <p><i>Dip coasts</i> Where alternating hard and soft layers intersect the coast at an angle; cannot always be distinguished from trellis coasts.</p> <ol style="list-style-type: none"> (a) <i>Heterogeneous formation coasts</i> Where wave erosion has cut back the weaker zones, leaving great irregularities. 	3-8
<p>B. <i>Marine deposition coasts</i> Coasts prograded by waves and currents.</p> <ol style="list-style-type: none"> 1. <i>Barrier coasts.</i> <ol style="list-style-type: none"> (a) <i>Barrier beaches</i> Single ridges. (b) <i>Barrier islands</i> Multiple ridges, dunes, and overwash flats. (c) <i>Barrier spits</i> Connected to mainland. (d) <i>Bay barriers</i> Sand spits that have completely blocked bays. (e) <i>Overwash fans</i> Lagoonward extension of barriers due to storm surges. 2. <i>Cuspate forelands</i> Large projecting points with cusp shape. Examples include Cape Hatteras and Cape Canaveral. 	3-9
<ol style="list-style-type: none"> 3. <i>Beach plains</i> Sand plains differing from barriers by having no lagoon inside. 4. <i>Mud flats or salt marshes</i> Formed along deltaic or other low coasts where gradient offshore is too small to allow breaking waves. 	3-10 3-11
<p>C. <i>Coasts built by organisms</i></p> <ol style="list-style-type: none"> 1. <i>Coral reef coasts</i> Include reefs built by coral or algae. Common in tropics. Ordinarily, reefs fringing the shore and rampart beaches are found inside piled up by the waves. <ol style="list-style-type: none"> (a) <i>Fringing reef coasts</i> Reefs that have built out the coast. (b) <i>Barrier reef coasts</i> Reefs separated from the coast by a lagoon. (c) <i>Atolls</i> Coral islands surrounding a lagoon. (d) <i>Elevated reef coasts</i> Where the reefs form steps or plateaus directly above the coast. 2. <i>Serpulid reef coasts</i> Small stretches of coast may be built out by the cementing of serpulid worm tubes onto the rocks or beaches along the shore. Also found mostly in tropics. 3. <i>Oyster reef coasts</i> Where oyster reefs have built along the shore and the shells have been thrown up by the waves as a rampart. 4. <i>Mangrove coasts</i> Where mangrove plants have rooted in the shallow water of bays, and sediments around their roots have built up to sea level, thus extending the coast. Also a tropical and subtropical development. 5. <i>Marsh grass coasts</i> In protected areas where salt marsh grass can grow out into the shallow sea and, like the mangroves, collect sediment that extends the land. Most of these coasts could also be classified as mud flats or salt marshes. 	3-12

the last 20 years because of urban runoff and industrial pollution. As a result, the unique way of life of the Chesapeake oystermen, who still use sailing vessels, may be at an end. Possibly because most attention has centered on the biological and commercial aspects of estuaries, our geological understanding of them is still rudimentary (Nichols and Biggs 1985). However, estuaries comprise a significant component of what may be termed the estuarine environment: the complex of lagoon-bay-inlet-tidal flat and marsh. These environments make up 80 to 90 percent of the U.S. Atlantic and Gulf coasts (Emery 1967), and clearly it is vital that we gain a better understanding of their sedimentary characteristics and dynamics.

b. Literature. Unfortunately, only the briefest introduction to estuarine processes and sediments can be presented in this manual. The purpose of this section is to introduce estuarine classification, regional setting, and geology. The reader is referred to Nichols and Biggs (1985) for an excellent overview of the geology and chemistry of estuaries and for an extensive bibliography. Other general works include Dyer (1979) and Nelson (1972). Cohesive sediment dynamics are covered in Metha (1986), and the physics of estuaries are covered in van de Kreeke (1986). Research from the 1950's and 1960's is covered in Lauff (1967).

c. Classification. Numerous attempts have been made to define and classify estuaries using geomorphology, hydrography, salinity, sedimentation, and ecosystem parameters (reviewed in Hume and Herdendorf (1988)). A geologically based definition, which accounts for sediment supply pathways, is used in this text.

d. Definitions. Estuaries are confined bodies of water that occupy the drowned valleys of rivers that are not currently building open-coast deltas. The most common definition of estuary describes it as a body of water where "...seawater is measurably diluted with fresh water derived from land drainage" (Pritchard 1967). Therefore, estuaries would include bodies of water where salinity ranges from 0.1 ‰ (parts per thousand) to about 35 ‰ (Figure 3-1). However, this chemical-based definition does not adequately restrict estuaries to the setting of river mouths, and allows, for example, lagoons behind barrier islands to be included. Dalrymple, Zaitlin, and Boyd (1992) felt that the interaction between river and marine processes was an attribute essential to all true estuaries. Therefore, they proposed a new geologically based definition of estuary as:

...the seaward portion of a drowned valley system which receives sediment from both fluvial and marine sources and which contains facies influenced by tide, wave, and fluvial processes. The estuary is considered to extend from the landward limit of tidal facies at its head to the seaward limit of coastal facies at its mouth.

These limits are schematically shown in Figure 3-1.

e. Time relationships and evolution.

(1) Estuaries, like other coastal systems, are ephemeral. River mouths undergo continuous geological evolution, of which estuaries represent one phase of a continuum (Figure 3-2). During a period of high sediment supply and low rate of sea level rise, an estuary is gradually filled. Three coastal forms may result, depending on the balance between riverine input and marine sediment supply. If the sediment is supplied by a river, a delta is formed, which, as it grows, progrades out into the open sea. If, instead, most sediment is delivered to the area by marine processes, a straight, prograding coast is formed. This might be in the form of beach ridges or strand plains if wave energy is dominant, or as open-coast tidal flats if tidal energy is dominant. At a later time, if sea level rises at a higher rate, then the river valley may be flooded, forming a new estuary (Figure 3-2).

(2) Under some conditions, such as when sea level rise and sediment supply are in balance, it may be difficult to distinguish whether a river mouth should be classified as an estuary or as a developing delta. Dalrymple, Zaitlin, and Boyd (1992) suggest that the direct transport of bed material may be the most fundamental difference between estuaries and deltas. They state that the presence of tight meanders in the channels suggests that bedload transport is landward in the region seaward of the meanders and, as a consequence, the system is an estuary. However, if the channels are essentially straight as far as the coast, bedload is seaward throughout the system and it can be defined as a delta.

f. Overall geomorphic characteristics. The new definition implies that sediment supply does not keep pace with the local sea level rise; as a result, estuaries become sinks for terrestrial and marine sediment. Sedimentation is the result of the interaction of wave, tide, and riverine forces. All estuaries, regardless of whether they are wave- or tide-dominated, can be divided into three zones (Figure 3-1):

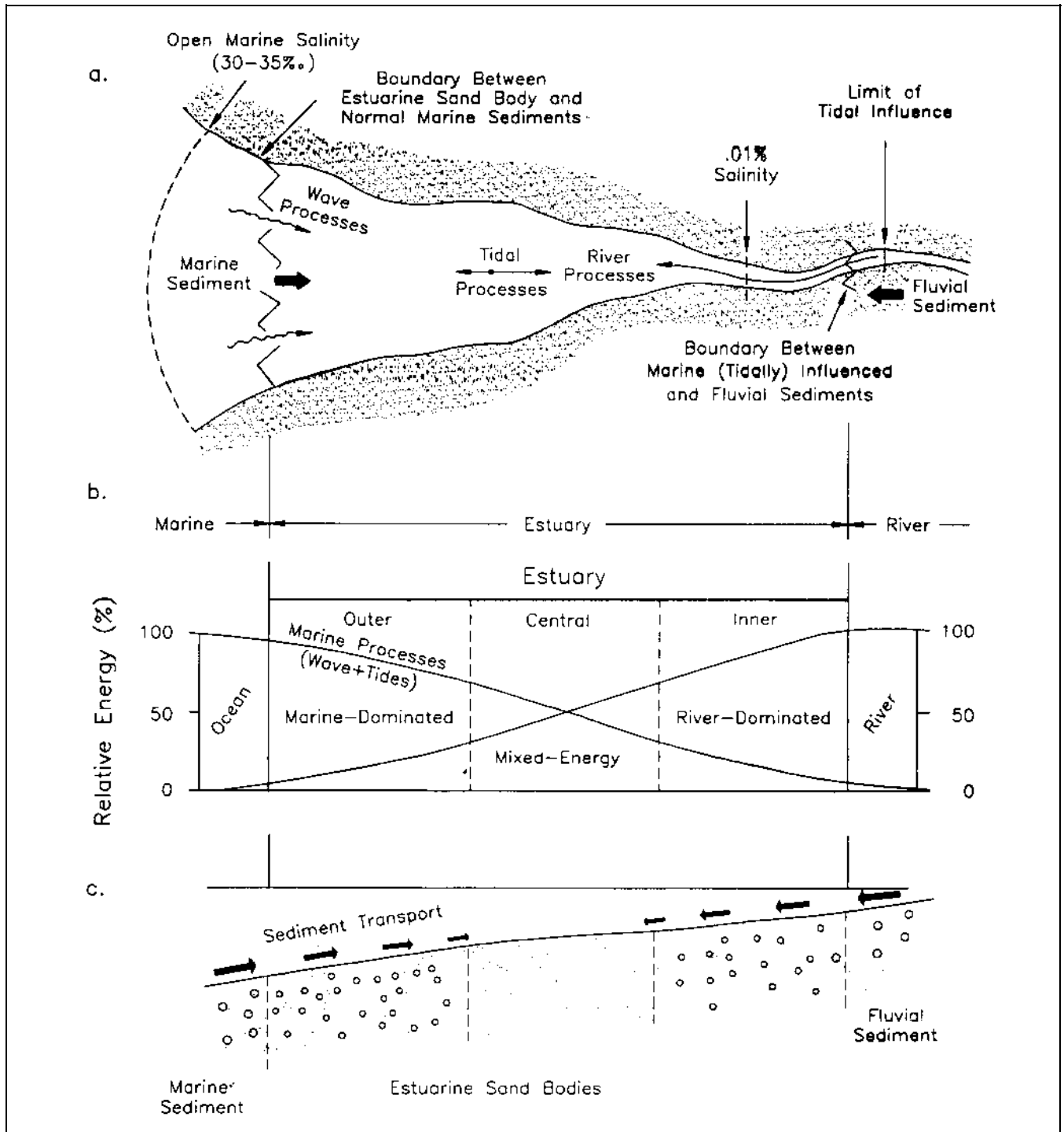

Figure 3-1. a. Plan view of distribution of energy and physical processes in estuaries; b. Schematic definition of estuary according to Dalrymple, Zaitlin, and Boyd (1992); c. Time-averaged sediment transport paths

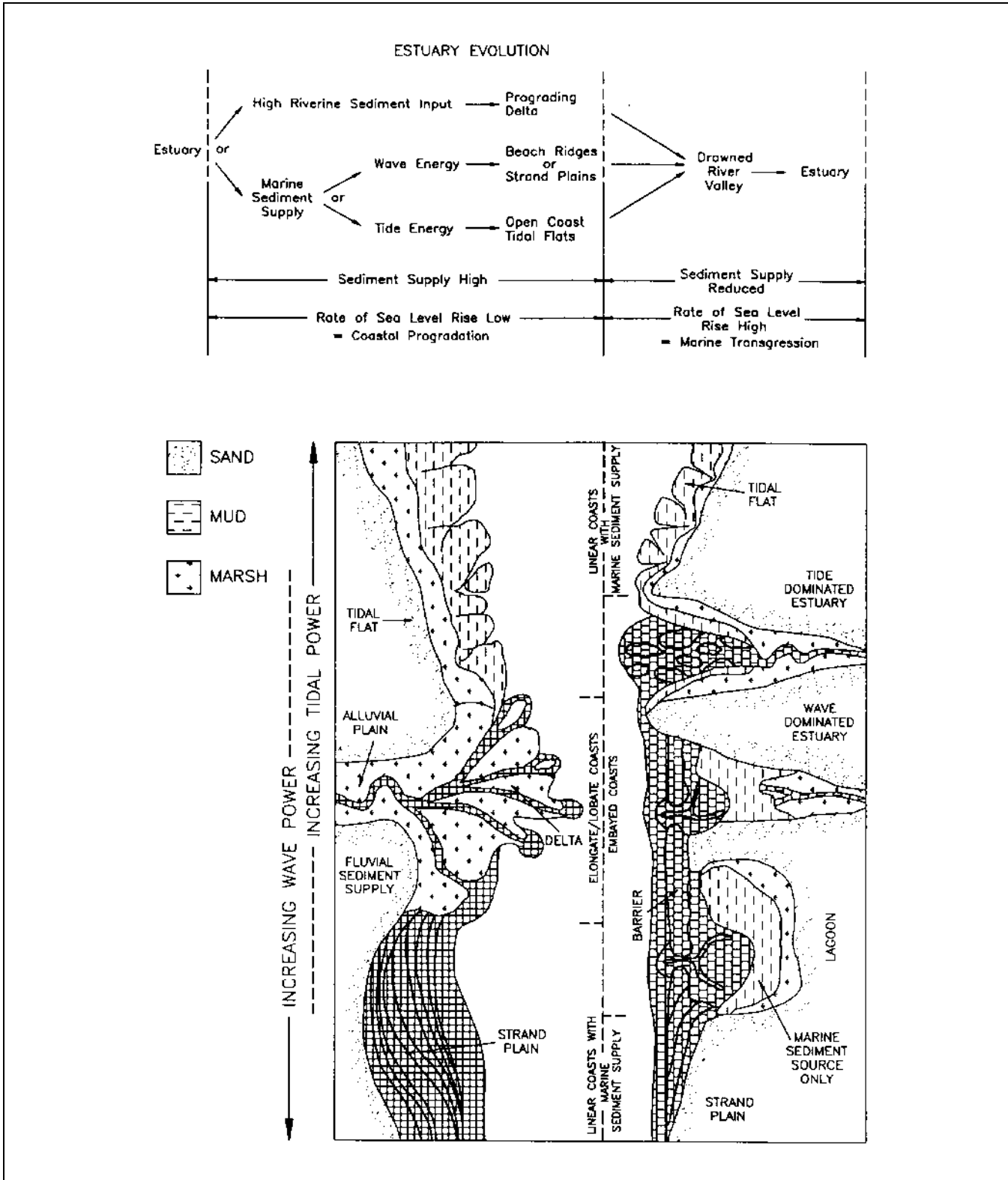

Figure 3-2. Estuary evolution, based on changes in sediment supply and rate of sea level change (adapted from Boyd, Dalrymple, and Zaitlin (1992))

(1) The outer zone is dominated by marine processes (wave and tidal currents). Because of currents, coarse sediment tends to move up into the mouth of the estuary.

(2) The central zone is characterized by relatively low energy, where wave and tidal currents are balanced long-term by river currents. The central zone is an area of net convergence of sediment and usually contains the finest-grained bed load present in the estuary.

(3) The inner zone is river-dominated and extends upriver to the limit of tidal influence. The long-term (averaged over years) bed load transport in this region is seaward.

g. *Energy factors and sedimentary structures.*

(1) Wave-dominated estuaries.

(a) This type of estuary is characterized by high wave energy compared to tidal influence. Waves cause sediment to move alongshore and onshore into the mouth of the estuary, forming sandbars or subaerial barriers and spits (Figure 3-3a). The barrier prevents most of the wave energy from entering the central basin. In areas of low tide range and small tidal prism, tidal currents may not be able to maintain the inlet, and storm breaches tend to close during fair weather, forming enclosed coastal ponds. Sediment type is well-distributed into three zones, based on the variation of total energy: coarse sediment near the mouth, fine in the central basin, and coarse at the estuary head. A marine sand body forms in the high wave energy zone at the mouth. This unit is composed of barrier and inlet facies, and, if there is moderate tide energy, sand deposited in flood-tide deltas (Hayes 1980).

(b) At the head of the estuary, the river deposits sand and gravel, forming a bay-head delta. If there is an open-water lagoon in the central basin, silts and fine-grained organic muds accumulate at the toe of the bay-head delta. This results in the formation of a prodelta similar to the ones found at the base of open-coast deltas (deltaic terms and structures are discussed in Chapter 4). Estuaries that are shallow or have nearly filled may not have an open lagoon. Instead, they may be covered by extensive salt marshes crossed by tidal channels.

(2) Tide-dominated estuaries.

(a) Tide current energy is greater than wave energy at the mouth of tide-dominated estuaries, resulting in the development of elongate sandbars (Figure 3-3b). The bars dissipate wave energy, helping protect the inner

portions of the estuary. However, in funnel-shaped estuaries, the incoming flood tide is progressively compressed into a decreasing cross-sectional area as it moves up the bay. As a result, the velocity of the tide increases until the effects of the amplification caused by convergence are balanced by frictional dissipation. The velocity-amplification behavior is known as *hypersynchronous* (Nichols and Biggs 1985). Because of friction, the tidal energy decreases beyond a certain distance in the estuary, eventually becoming zero.

(b) As in wave-dominated estuaries, riverine energy also decreases downriver from the river mouth. The zone where tide and river energy are equal is sometimes called a balance point and is the location of minimum total energy. Because the total-energy minimum is typically not as low as the minimum found in wave-dominated estuaries, tide-dominated estuaries do not display as clear a zonation of sediment facies. Sands are found along the tidal channels, while muddy sediments accumulate in the tidal flats and marshes along the sides of the estuary (Figure 3-3b). In the central, low-energy zone, the main tidal-fluvial channel consistently displays a sinuous, meandering shape. Here, the channel develops alternate bars at the banks and, sometimes, in mid-channel.

(c) A bay-head delta is usually not present in the river-dominated portion of tidally dominated estuaries. Instead, the river channel merges directly into a single or a series of tidal channels that eventually reach the sea.

(3) Estuarine variability.

(a) Wave to tide transition. As tide energy increases relative to wave energy, the barrier system at the mouth of the estuary becomes progressively more dissected by tidal inlets, and elongate sandbars form along the margins of the tidal channels. As energy levels increase in the central, mixed-energy part of the estuary, marine sand is transported further up into the estuary, and the muddy central basin is replaced by sandy tidal channels flanked by marshes.

(b) Effects of tide range. The inner end of an estuary has been defined as the limit of detectable tidal influence. Therefore, the gradient of the coastal zone and the tide range have a great influence on the length of estuaries (Dalrymple, Zaitlin, and Boyd 1992). Estuaries become longer as gradient decreases and tide range increases.

(c) Influence of valley shape. The shape of the flooded valley and the pre-existing geology also control the size of the estuary and the nature of sediment

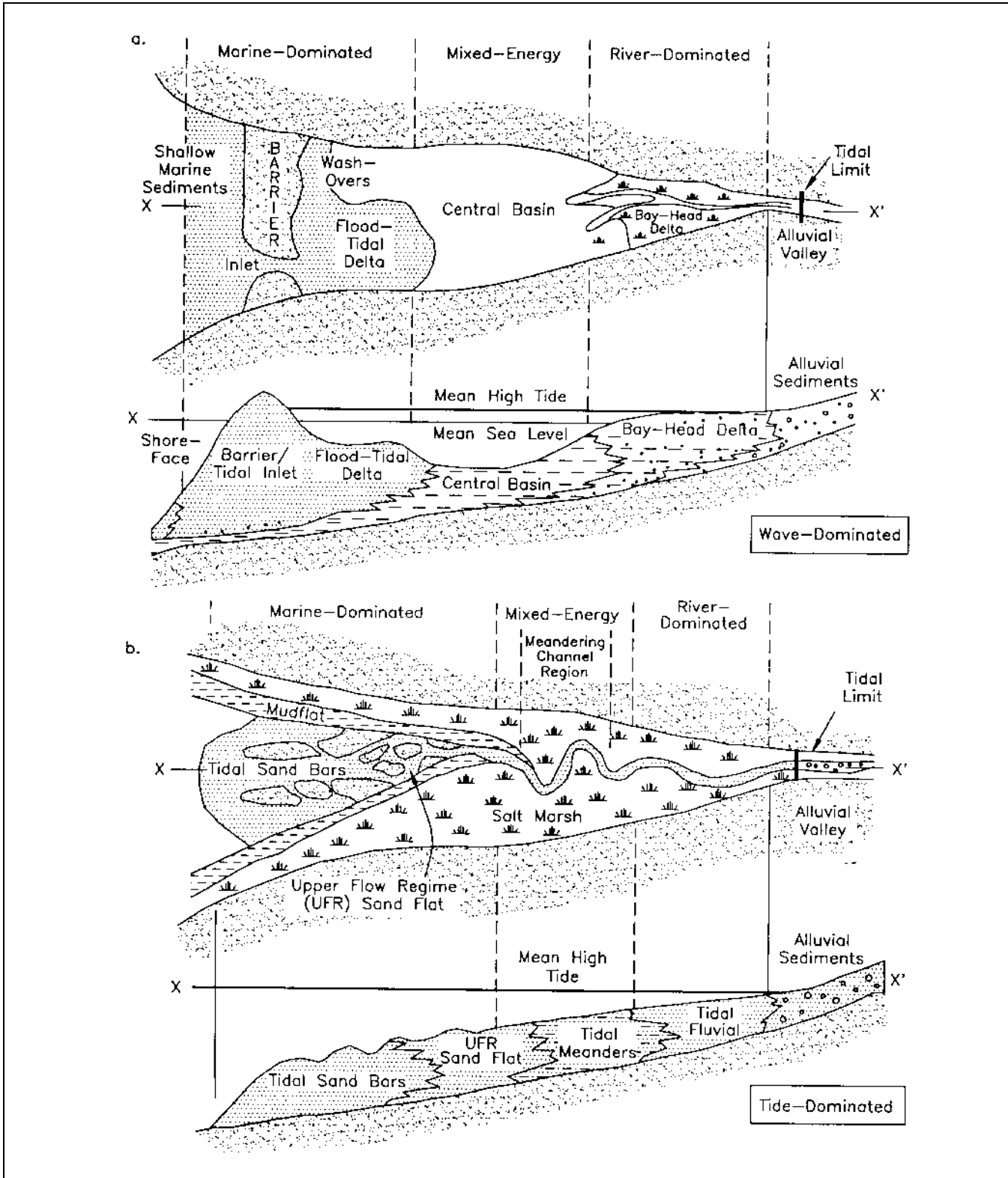

Figure 3-3. Morphologic models of (a) wave-dominated and (b) tide-dominated estuaries (adapted from Dalrymple, Zaitlin, and Boyd (1992))

deposition. This is particularly evident during the early phases of estuary infilling, before erosion and deposition have modified the inherited geology. For example, tidal-wave amplification is less likely to occur in irregular valleys (Nichols and Biggs 1985). The resulting estuaries are more likely to become wave-dominated. Chesapeake Bay, with its extensive system of tributary valleys, is an example of this type. In contrast, estuaries which initially or later have developed a funnel shape are more likely to be tide-dominated and hypersynchronous (for example, the Gironde Estuary of France.)

(d) Geologic setting. Coastal plain gradient, part of the overall plate tectonic setting, is one factor that determines estuary volume. Sea level rise over a flat coastal plain on a passive margin like the Gulf of Mexico creates a long estuary with large volume. An equivalent rise on a steep, active-margin coast like the U.S. Pacific coast will result in a much smaller estuary volume (Boyd, Dalrymple, and Zaitlin 1992).

3-4. Drowned Glacial Erosion Coasts

During the Pleistocene epoch, massive continental glaciers, similar to the present Antarctic and Greenland ice caps, covered broad parts of the continents. The glaciers waxed and waned in cycles, probably as a result of climatic variations, causing great modifications to the morphology of coastal regions in the northern latitudes. As a result, glacially modified features dominate the northern coasts and continental shelves, although in some areas marine processes have reworked the shore and substantially modified the glacial imprint.

a. Erosion and sediment production. Because glacial ice is studded with rock fragments plucked from the underlying rock, a moving glacier performs like a giant rasp that scours the land surfaces underneath. This process, along with the great size and weight of the ice sheets, caused enormous erosion and modification of land areas covering thousands of square kilometers during the Pleistocene.

(1) Fjords. The most spectacular erosion forms are drowned glacial valleys known as fjords that indent the coasts of Alaska, Norway, Chile, Siberia, Greenland, and Canada (Figure 3-4). The overdeepened valleys were invaded by the sea as sea level rose during the Holocene. Today, fjords retain the typical U-shaped profile which is also seen in formerly glaciated mountain valleys.

(2) Depositional features. As a glacier moves, huge amounts of sediment are incorporated into the moving

mass. When the ice melts at the glacial front's furthest advance, the sediment load is dropped. Although the major part of the transported material is dumped in the form of a terminal moraine, some sediments are carried further downstream by meltwater streams (Reineck and Singh 1980). The result is a number of distinctive geomorphic features such as drumlins, fjords, moraines, and outwash plains that may appear along the coast or on the submerged continental shelf (Figure 3-5). During submergence by the transgressing sea, the features may be modified to such a degree that their glacial origin is lost. This is especially true of outwash, which is easily reworked by marine processes. Examples of drowned drumlins include the islands in Boston Harbor. Long Island, New York, is a partially submerged moraine that has been extensively reworked.

b. Variability. Glaciated coasts typically display a greater variety of geomorphic forms than are seen in warmer latitudes. The forms include purely glacial, glacio-fluvial, and marine types (Fitzgerald and Rosen 1987). Complexity is added by marine reworking, which can produce barriers, shoals, gravel shores, and steep-cliffed shores. Because of the steep slopes of many glacial coasts, slumping and turbidity flow are major erosive agents. In northern latitudes, the shallow seafloor is gouged by icebergs. In summary, classification of shores in drowned glacial environments can be a major challenge because of the complicated geological history and the large diversity of structures.

c. Atlantic coast. A fundamental division of coastal characteristics occurs along the Atlantic coast of North America due to the presence of glacial moraines. The Wisconsin terminal moraine formed a prominent series of islands (i.e. Long Island, Block Island, Nantucket, and Martha's Vineyard) and offshore banks (Georges and Nova Scotian Banks). South of the moraine, the topography is flatter and more regular, except for piedmont streams, which intersect the coastal plain.

d. Offshore geology. Coasts altered by glaciers tend to have offshore regions which are highly dissected by relict drainage systems. These sinuous stream channels display highly irregular and varied topography and are composed of sediment types ranging from outwash sand and gravels to till. Note that relict stream channels are also found on continental shelves in temperate climates, for example off the coast of Texas (Suter and Berryhill 1985). The channels from both temperate and colder environments, and the associated shelf-margin deltas, were formed during late Quaternary lowstands of sea level and are indicators of the position of ancient coastlines.



Figure 3-4. Glacial coastline, Alaska (Lake George, with Surprise glacier in the background)

3-5. River Deposition Coasts - Deltas

Deltas are discussed in Chapter 4, Section 3. Because energy factors and deltaic structures are intimately linked, morphology and river mouth hydrodynamics are discussed together.

3-6. Wind Deposition Coasts - Dunes

Sand dunes are common features along sandy coastlines around the world. The only climatic zone lacking extensive coastal dunes is the frozen Arctic and Antarctic (although thin dune sheets on the coast of McMurdo Sound, Antarctica, have been described by Nichols (1968)). Sediment supply is probably the most crucial factor controlling growth of dunes; while there is rarely a lack of wind in most coastal areas, some lack sufficient loose sediment (Carter 1988). Dunes serve multiple valuable purposes: as recreational areas, as habitat for various species of birds, as shore protection, and as temporary sources and sinks of sand in the coastal environment. Although dunes are found along many sandy coasts, they are finite resources and need to be protected and preserved. The seminal work on dunes is Brigadier

R.A. Bagnold's *The Physics of Blown Sand and Desert Dunes* (Bagnold 1941). More than 50 years after its publication, this book continues to be cited because of its sound basis on the laws of physics and its readability.

a. Origin. Many large dune fields are believed to have originated when sea level was lower and sediment supply greater (Carter 1988). Many are on prograding shorelines, although shoreline advance does not seem to be a necessary requirement for dune formation. In northwest Europe, most of the dunes formed from shelf debris that moved onshore during the late Pleistocene and early Holocene by rising sea level. Dune-building phases have been interrupted by periods of relative stability, marked by the formation of soils. The dunes at Plum Island, Massachusetts, may have formed after 1600 (Goldsmith 1985).

b. Sediment source. The normally dry backshore of sandy beaches may be the most common source of dune sands. A flat or low-relief area inland of the coastline is needed to accommodate the dunes, and there must be predominant onshore or alongshore winds for at least part of the year. To move sand from the beach to the dunes,

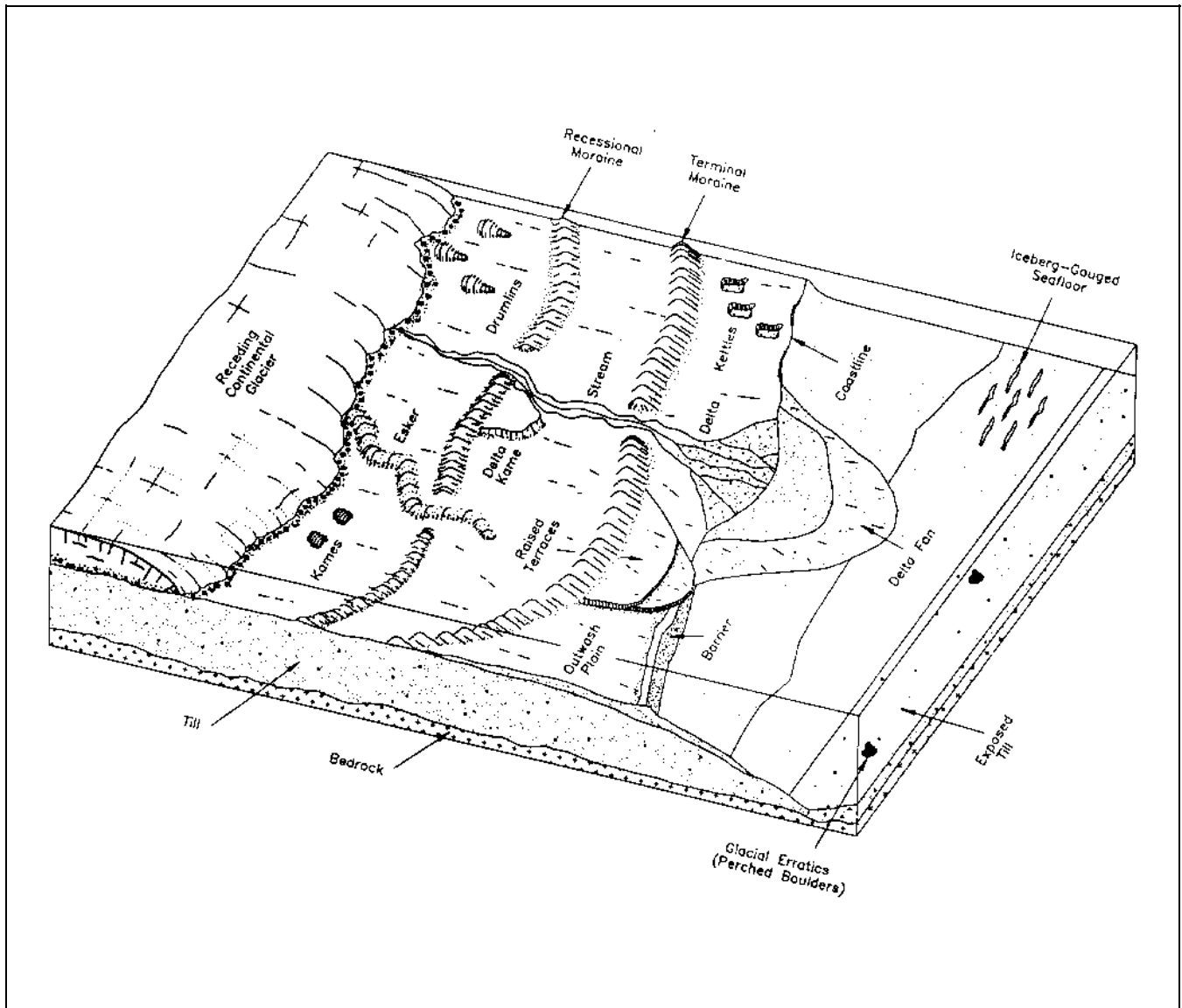

Figure 3-5. Typical glacial depositional structures

wind speed must exceed a threshold velocity for the particular size of sand available. If the sand is damp or if the grains must move up a slope, the velocities required for sediment transport are greatly increased. The foreshore of the beach can also be a source of sand if it dries between tidal cycles. This is especially true in areas where there is only one high tide per day (diurnal), allowing a greater amount of time for the foreshore to dry between inundations. Sand storage in dunes must be estimated as one component of sediment budget calculations (EM 1110-2-1502).

c. *Modification and stability.* Most dunes show evidence of post-depositional modifications. These include:

- Physical changes - slumping, compaction. Sand grains become rounded, frosted, and better sorted.
- Chemical alterations - oxidation, leaching, calcification. (The latter can solidify a dune, making it much more resistant to erosion.)

- Biological effects - reactivation, humification, soil formation.

The stability of dunes varies greatly, usually depending on the amount of vegetation cover. Dunes in arid climates are often not vegetated and tend to be mobile. However, coastal dunes are normally vegetated by plant species that are adapted to the harsh coastal environment (Figure 3-6). Many dune grasses have long roots, rhizomes, and runners that help hold sand in place. In addition, dense vegetation

displaces the aerodynamic boundary of the wind velocity profile upwards. This process produces a net downward momentum flux, promoting sediment trapping (Carter 1988).

d. Classification. Dunes can be described or classified on the basis of physical description (external form and internal bedding) or genetic origin (mode of formation). Smith (1954) devised a descriptive



Figure 3-6. Partly vegetated coastal sand dunes. Rhizomes help hold sand in place and colonize the dune grasses. Eastern Alabama near Florida/Alabama state line (March 1991). This area was devastated by Hurricane Frederic in 1979 and is slowly recovering

classification system that has been widely used. It established the following types (Figure 3-7):

(1) *Foredunes*. Mounds or ridges directly adjacent to the beach. Serve as storm buffer.

(2) *Parabolic dunes*. Arcuate sand ridges with the concave portion facing the beach. Rare; often form downwind of pools or damp areas.

(3) *Barchan dunes*. Crescent-shaped dunes with the extremities (horns) extending downwind (caused by the horns migrating more rapidly than the central portions). Sometimes indicate incomplete sand cover moving over a non-erodible pavement.

(4) *Transverse dune ridges*. Ridges oriented perpendicular or oblique to the dominant winds. Their form is asymmetrical with steep lee and gentle upwind slopes.

(5) *Longitudinal (seif) dunes*. Dune ridges elongated parallel to the wind direction and symmetrical in profile. Occur in groups over wide areas; feature sinuous crestlines.

(6) *Blowouts*. Hollows or troughs cut into dunes may be caused when vehicles or pedestrians damage vegetation.

(7) *Attached dunes*. Formations of sand that have accumulated around obstacles such as rocks.

e. Shoreline protection. In many areas, dunes serve a vital role in protecting inland areas from storm surges and wave attack. As a result, many communities require that buildings be erected behind the dunes or beyond a certain distance (a setback) from an established coastline. Unfortunately, the protection is ephemeral because severe storms can overtop and erode the dunes, and changes in sediment supply or local wind patterns (sometimes brought about by structures and urban development) can leave them sand-starved. If dunes are cut for roads or for walkways, they become particularly vulnerable to erosion. However, compared to hard structures such as seawalls, many communities prefer the protection provided by dunes because of aesthetic considerations.

f. Dune restoration. Historically, sand dunes have suffered from human pressure, and many dune systems have been irreversibly altered by man, both by accident or design. Many coastal areas in Europe, North America, Australia, and South Africa, which had once-stable

forested dunes, have been deforested. The early settlers to New England in the 1600's severely damaged the dune vegetation almost immediately upon their arrival by overgrazing and farming. Dune rebuilding and revegetation have had a long history, most of it unsuccessful (Goldsmith 1985). Recent restoration practices have been more effective (Knutson 1976, 1978; Woodhouse 1978). The two main methods for rebuilding or creating coastal dunes are artificial planting and erecting sand fences. Hotta, Kraus, and Horikawa (1991) review sand fence performance. Coastal dune management and conservation practices are reviewed in Carter, Curtis, and Sheehy-Skeffington (1992).

3-7. Volcanic Coasts

a. Introduction and definitions. *Volcanoes* are vents in the earth's surface through which magma and associated gases and ash erupt (Bates and Jackson 1984). Often, conical mountains are formed around the vents as repeated eruptions deposit layer upon layer of rock and ash. Therefore, the definition is extended to include the hill or mountain built up around the opening by the accumulation of rock materials.

(1) The fundamental importance of volcanism to mankind has been clearly documented around the world. The entire west coast of the United States is highly active tectonically and most of the continent's volcanoes are within 200 km of the coast. There are over 260 morphologically distinct volcanoes younger than 5 million years in the United States and Canada alone, most of which are in Alaska and the Hawaiian Islands (Wood and Kienle 1990). Fifty-four have erupted in historic times, and distant memories of others are recounted in Native American legends.

(2) Volcanoes are important to coastal studies for a number of reasons:

- They provide sediment to the littoral environment. Material may reach the coast directly via ash fallout and lava flows or may be transported by rivers from an inland source (e.g., Mount St. Helens).
- Vulcanism affects coastal tectonics (e.g., west coasts of North and South America).
- Shoreline geometry is affected by the formation of volcanic islands (Aleutians) and by lava that flows into the sea (Hawaiian Islands).

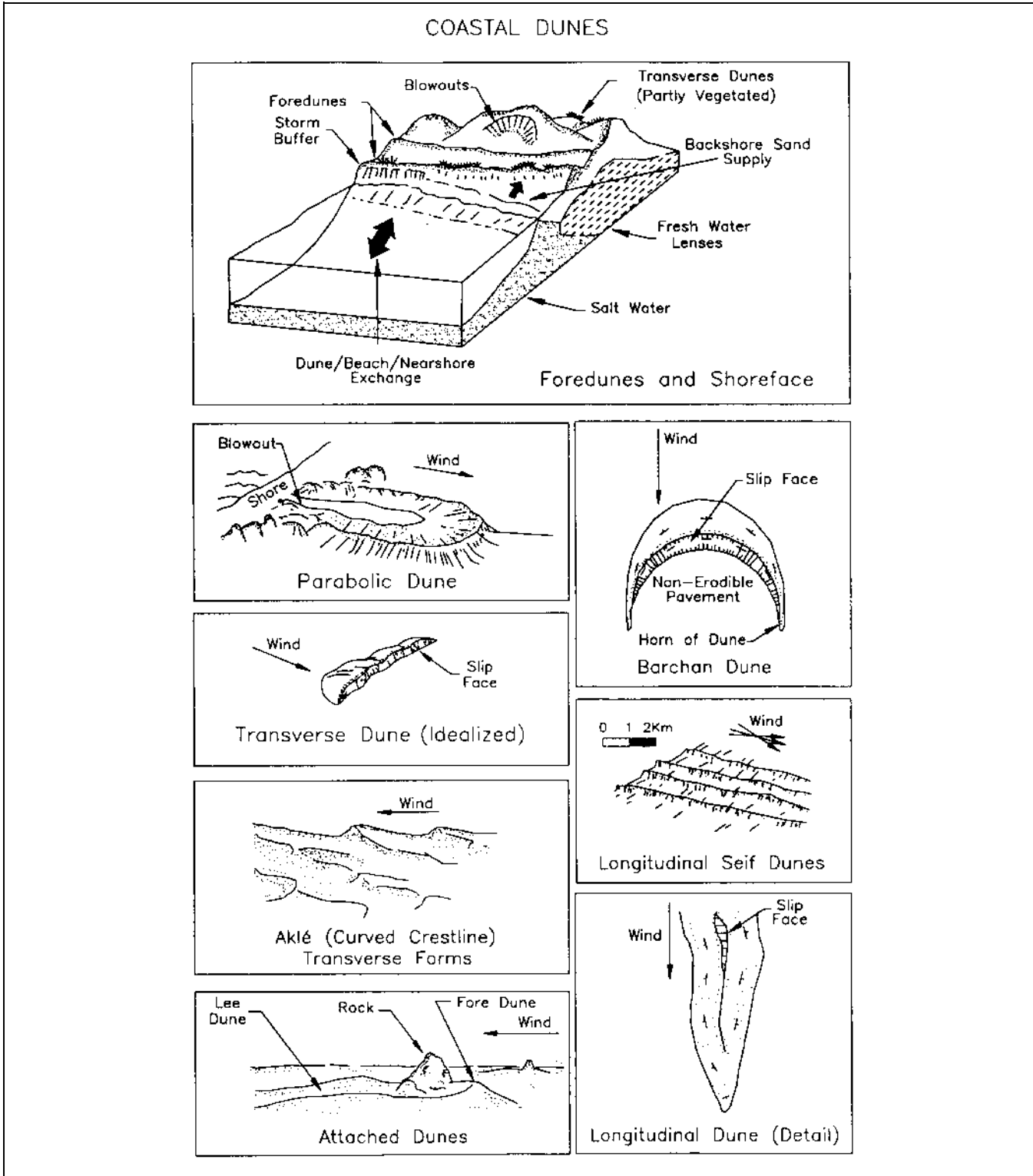

Figure 3-7. Variety of dune types. Adapted from Carter (1988), Reading (1986), and Flint (1971)

- Shoreline erodability ranges from very erodable for ash and unconsolidated pyroclastic rubble to very resistant for basalt.
- Volcanoes can pose a serious threat to coastal communities.
- Volcanic debris can choke rivers and harbors.

(3) This section briefly discusses general concepts of volcanism and describes features unique to volcanic shores. Examples from Alaska and the Hawaiian Islands illustrate the differences between composite and shield volcanoes and their associated coastlines. For the general reader, *Exploring our Living Planet*, published by the National Geographic Society (Ballard 1983), is a readable and interesting introduction to plate tectonics, hotspots, and volcanism.

b. General geology. Two classes of volcanoes can be identified, based on the explosiveness of their eruptions and composition of their lava. The ones in the Aleutians and along the west coasts of North and South America are known as *composite* volcanoes and are renowned for their violent eruptions (the paroxysmal explosion of Mount St. Helens on May 18, 1980, which triggered devastating mudflows and floods, killing 64 people, serves as an extraordinary example). Composite eruptions produce large amounts of explosive gas and ash and tend to build classic, high-pointed, conic mountains. In contrast, the Hawaiian Islands are *shield* volcanoes: broad, low, basalt masses of enormous volume. Shield eruptions are typically non-explosive, and the highly liquid nature of their lava¹ accounts for the wide, low shape of the mountains. Volcanism affects the shore on two levels:

(1) The large-scale geologic setting of the continental margin affects sedimentation and overall coastal geology. Margins subject to active tectonism (and volcanism) are typically steep, with deep water occurring close to shore. Rocks are often young. High mountains close to shore provide a large supply of coarse sediments, and there are usually no or only minimal muddy shores. Much sediment may be lost to deep water, particularly if it is funneled down submarine canyons. This is a one-way process, and the sediment is permanently lost to the coastal zone.

¹ *Lava* is the term used for molten rock (and gasses within the liquid) that have erupted onto the earth's surface. *Magma* refers to molten rock that is still underground.

(2) Small-scale structures on volcanic shores may differ from those on clastic passive margins. Sediment supply may be frequently renewed from recent eruptions and may range greatly in size. Ash may be quickly destroyed in the sea, while basalt boulders may be tremendously resistant. Hardened shores at the sites of recent lava flows are difficult settings for harbor construction.

c. Composite volcanoes - coastal Alaska. The coastal geology of Alaska is incredibly complex, having been shaped by fault tectonics, volcanism, glaciation, fluvial processes, sea level changes, and annual sea ice. Over 80 volcanoes have been named in the Aleutian arc, which extends for 2,500 km along the southern edge of the Bering Sea and the Alaskan mainland (Wood and Kienle - 1990). Over 44 have erupted, some repeatedly, since 1741, when written records began. Aleutian arc volcanism is the result of the active subduction of the Pacific Plate beneath the North America Plate (Figure 3-8).

(1) Volcanoes have influenced the Aleutian Arc in two ways. First, they have been constructive agents, creating islands as eruption after eruption has vented rock and ash. In some places, fresh lava or mudflows accompanying eruptions have buried the existing coast, extending the shore seaward. The eruptions of Mts. Katmai and Novarupta in 1912 produced ash layers 3- to 15-m thick. The Katmai River and Soluka Creek carried vast amounts of loose ash to the sea, filling a narrow bay and burying a series of old beach ridges (Shepard and Wanless 1971). In general, loose mudflow and ash deposits are reworked rapidly by waves, providing sediment for beach development. In addition, for years after an eruption, streams may carry rock and ash to the coast, allowing the coast to locally prograde. The other effect has been destructive, and small islands have been largely destroyed by volcanic explosions. Bogoslof, in the eastern Aleutians, is an example in which both rapid construction and destruction have influenced the island's shape over time (Shepard and Wanless 1971).

(2) Clearly, a history of volcanic instability would be a major consideration for a coastal engineer planning a harbor or project. Most new volcanic islands are uninhabited, but harbors may be needed for refuge, military, or commercial purposes. Some islands may be able to supply stone for construction at other locations, requiring loading facilities for boats or barges.

d. Shield volcanoes - Hawaii. Each of the Hawaiian islands is made up of one or more massive shield volcanoes rising from the ocean floor. The islands are at the

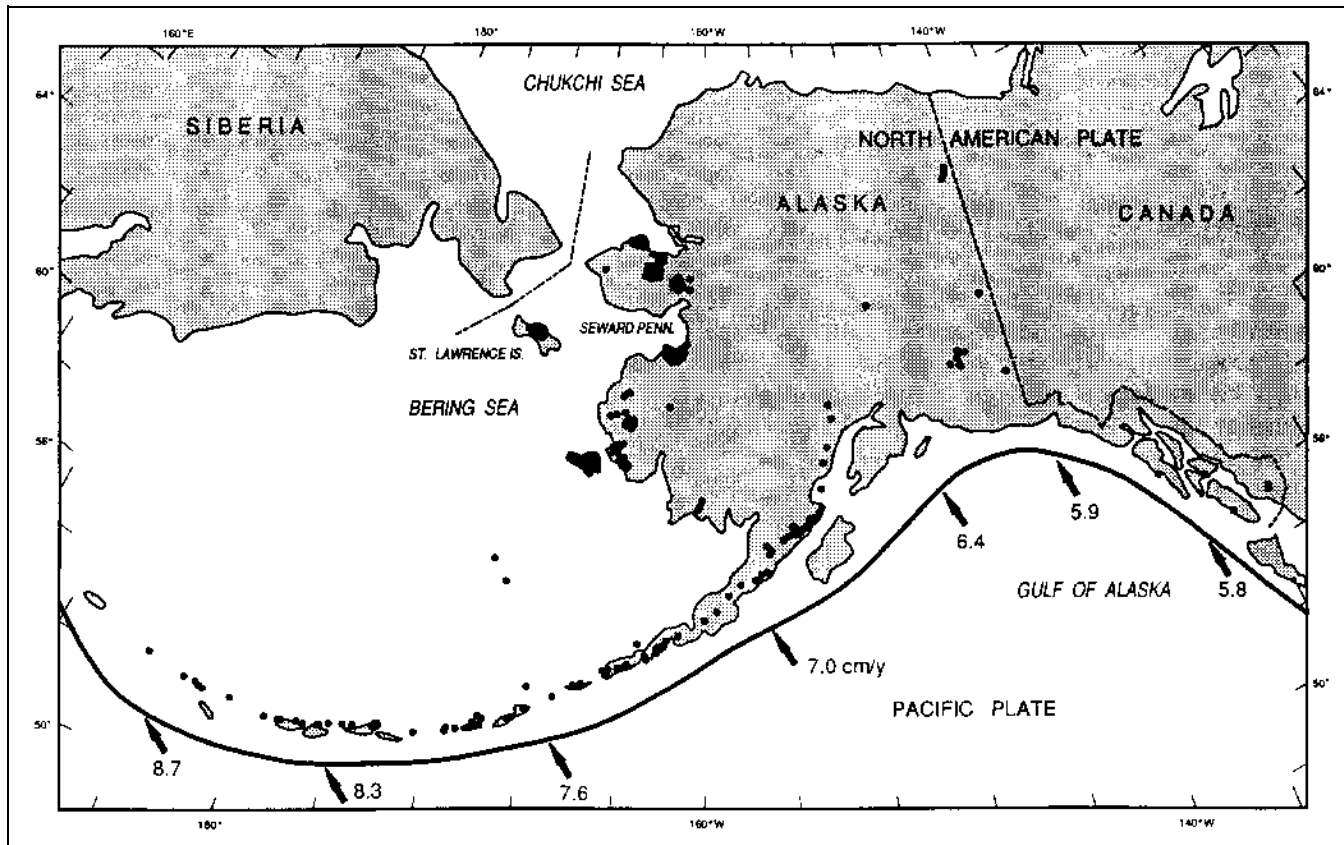

Figure 3-8. Alaskan volcanoes along the Aleutian island arc, marking the boundary between the North America and Pacific Plates. Arrows indicate subduction of the Pacific Plate in cm/year

southern end of a chain of seamounts that extends 3,400 km to the northwest and then turns north and extends another 2,300 km towards Kamchatka as the Emperor Seamounts. Over 100 volcanoes, representing a volume of over 1 million km³, make the Hawaiian-Emperor chain the most massive single source of volcanic eruption on earth (Wood and Kienle 1990). The submerged seamounts become successively older away from Hawaii. Meiji Seamount, about to be subducted beneath Kamchatka, is 75-80 million years (my) old, Kilauea is only 0.4 my, while Loihi Seamount, south of the big island of Hawaii, is the newest member of the chain and has not yet emerged from the sea. The islands are located over a semi-permanent "hot spot," a site where it is believed that a plume of hot, geochemically primitive material rises convectively through the mantle, interacts with the lithosphere, and vents on the seafloor (Dalrymple, Silver, and Jackson 1973). The Pacific plate is postulated to be moving over the hot spot at a rate of about 13 cm/yr, based on ages of the major vents on Hawaii (Moore and Clague 1992).

(1) Although the coastlines of the Hawaiian Islands are geologically young, wave erosion and the growth of coral reefs have modified most of the shores. Coastal plains have formed around the base of some volcanoes and between others (for example, the intermontaine plateau between Koolau and Waianae on Oahu). The plains are partly alluvial and partly raised reefs (Shepard and Wanless 1971). The greater part of the Hawaiian coasts are sea cliffs, some as high as 1,000 m on the windward sides of the islands. There are also extensive beaches, the best of which tend to be on the western sides of the islands, protected from waves generated by the northeast trade winds. On southwestern Kauai near Kekaha, there are prograding beach ridges. Surprisingly, most of the beaches are composed primarily of biogenic sediment. The rare volcanic sand beaches are found at the mouths of the larger rivers or along coasts where recent lava flows have killed the coral reefs (Shepard and Wanless 1971). Many beaches are undergoing serious erosion, and it has been difficult to find suitable sources of sand for renourishment. This is a critical problem because tourism is a

major part of the Hawaiian economy and the beaches are one of the great attractions.

(2) An example from the island of Hawaii helps illustrate the rugged nature of these volcanic shores. Hawaii, at the southeast end of the island chain, has been built up from at least seven independent volcanoes (Moore and Clague 1992). Mauna Loa, a huge dome at the southern end of the island, rises to 4,100 m above the sea (8,500 m above the seafloor). Kilauea, a low dome that rises out of the southeast side of Mauna Loa, has had a remarkable history of eruptions since 1800. Because of the porosity of the lavas, there are few permanent streams on the island although there is high rainfall on the windward side. The southeast coast of the island is a barren, rugged rock shore built up from numerous Kilauea lava flows (Figure 3-9). In Figure 3-9, the foreground consists of

cracked, barren basalt, while the plateau in the background supports a cover of grass. The vertical cliffs are about 10 m high and in areas have been notched or undercut by the surf. Small steep pocket beaches consisting of black volcanic sands have developed in some of the notches.

e. Hazards posed by volcanoes. Coastal projects and communities are subject to four general types of hazards as a result of volcanic eruptions:

- Explosion-generated tsunamis that can flood coastal areas.
- Direct burial by lava or ash (recently experienced in Hawaii, Iceland, and Sicily).



Figure 3-9. Southeast coast of Hawaii, near Kalapana. Rugged cliffs are built up of numerous lava flows

- Burial or disruption by mudflows and fluvial sediment from inland eruptions, and changes in stream drainage and coastal sediment discharge patterns.
- Loss of life and destruction from explosions.

Volcanoes seem a remote hazard to most people, but the danger is imminent and real to those who live in certain parts of the earth, especially along the boundaries of the earth's tectonic plates. Fortunately, fewer than 100 people have been killed by eruptions in Hawaii, where the volcanism is less explosive (Tilling, Heliker, and Wright 1987).

(1) Earthquakes and tsunamis.

(a) *Tsunamis* are waves created by ocean bottom earthquakes, submarine land-slides, and volcanic explosions. These long-period waves can travel across entire oceans at speeds exceeding 800 km/hr, causing extensive damage to coastal areas. The cataclysmic explosion of Krakatoa on August 27, 1883, generated waves over 30 m high that swept across the Sunda Strait, killing over 36,000 coastal residents on Java and Sumatra. The Hawaiian islands are particularly vulnerable to tsunamis caused by disturbances around the Pacific rim. The great April 1, 1946, tsunami generated towering walls of water that swept inland, damaging many coastal structures on the islands. In areas, the water rose to 16 m above the normal sea level. Photographs of the waves and the resulting damage are printed in Shepard and Wanless (1971) (Francis Shepard was living on Oahu at the time and vividly describes how the waves smashed his bungalow, forcing him and his wife to flee for their lives).

(b) Clearly, there is little that can be done to protect against the random and unpredictable tsunamis. A warning network has been established to notify people around the Pacific of earthquakes and the possibility that destructive waves may follow. Coastal residents are urged to heed these warnings!

(2) Ash and fluvial sediment. When Mount St. Helens exploded on May 18, 1980, 390 m of the top of the mountain was blown off, spewing a cloud of dust and ash high into the stratosphere. From its north flank, an avalanche of hot debris and scalding gasses created immense mudflows, burying the upper 24 km of the North Toutle valley to a depth of 50 m. Lahars, formed from dewatering of the debris avalanche, blocked the shipping channel of the Columbia River. This created an enormous dredging task for the USACE and ultimately much of the dredged material had to be disposed at sea.

Dredging related to the explosion continues 12 years after the eruption, as material continues to move downstream from mountain watersheds.

(4) Explosive destruction. Communities close to volcanoes may be destroyed by the explosion and the inhabitants killed by poisonous gasses and superheated steam.

(a) The coastal example frequently cited is the destruction of St. Pierre on Martinique by the violent explosion of Montagne Pelée on May 8, 1902. A glowing cloud overran St. Pierre and spread fanlike over the harbor. Practically instantly, the population of over 30,000 was obliterated, smothered with toxic gas and incinerated (Bullard 1962).

(b) The cloud that destroyed St. Pierre consisted of superheated steam filled with even hotter dust particles, traveling at over 160 km/hr. The term *nuée ardente* is now used to describe this type of swiftly flowing, gaseous, dense, incandescent emulsion. It is also used as a synonym for the Peléan type of eruption.

3-8. Sea Cliffs - Diastrophic, Erosional, and Volcanic

Sea cliffs are the most spectacular geomorphic features found along the world's coastlines. This section concentrates on bedrock cliffs, with *bedrock* defined as "the solid rock that underlies gravel, soil, or other superficial material" (Bates and Jackson 1984). Bedrock cliffs are found along most of the U.S. and Canadian Pacific coast, in Hawaii, along the Great Lakes shores, and in Maine. South of Maine along the Atlantic coast, cliffs are rare except for examples in New Hampshire, Massachusetts, and Rhode Island. Cliffs constitute the major portion of the coastlines of Spain, Italy, Greece, Turkey, Iceland, and the South American nations facing the Pacific Ocean. Shorelines with cliffs may be both emergent or submergent. For more information, Trenhaile's (1987) *The Geomorphology of Rock Coasts* presents a comprehensive and global review of cliffs, shore platforms, and erosion and weathering processes.

a. Bedrock cliffs are composed of all three major rock types, igneous, sedimentary, and metamorphic:

(1) *Intrusive igneous rock*, such as granite, cools and solidifies beneath the earth's surface, while *extrusive igneous rock*, such as basalt, is formed by lava above ground (may erupt underwater or on land). Igneous rocks tend to be highly resistant; however, two properties are of

great importance to their susceptibility to weathering and erosion (de Blij and Muller 1993):

(a) *Jointing* is the tendency of rocks to develop parallel sets of fractures without obvious external movement like faulting.

(b) *Exfoliation*, caused by the release of confining pressure, is a type of jointing which occurs in concentric shells around a rock mass.

(2) *Sedimentary rock* results from the deposition and lithification (compaction and cementation) of mineral grains derived from other rocks (de Blij and Muller 1993). This category also includes rock created by precipitation (usually limestone).

(a) The particles (clasts) that make up *clastic sedimentary rock* can range in size from windblown dust to waterborne cobbles and boulders. The vast majority of sedimentary rocks are clastic. Common examples include sandstone, composed of lithified sand (usually consisting mostly of quartz), and shale, made from compacted mud (clay minerals). Many of the cliffs along the south shore of Lake Erie are shale.

(b) *Nonclastic sedimentary rocks* are formed by precipitation of chemical elements from solution in marine and fresh water bodies as a result of evaporation and other physical and biological processes. The most common nonclastic rock is limestone, composed of calcium carbonate (CaCO_3) precipitated from seawater by marine organisms (and sometimes also incorporating marine shell fragments). Many of the Mediterranean cliffs are limestone and are very vulnerable to dissolution.

(3) *Metamorphic rocks* are pre-existing rocks that have been changed by heat and pressure during burial or by contact with hot rock masses. Common examples include:

(a) *Quartzite*, a very hard, weathering-resistant rock, formed from quartz grains and silica cement.

(b) *Marble*, a fine-grained, usually light-colored rock formed from limestone.

(c) *Slate*, a rock that breaks along parallel planes, metamorphosed from shale.

b. Sea cliffs are formed by three general processes:

- Volcanic eruptions and uplift caused by local volcanism (discussed in paragraph 3-7).
- Diastrophic activity that produces vertical movement of blocks of the crust.
- Erosional shorelines - partial drowning of steep slopes in hilly and mountainous terrain and resulting erosion and removal of sediment.

c. *Faulted coastlines*. Sea cliffs, often found on tectonically active coasts, may be created by two mechanisms. First, if a block of the coast drops, a newly-exposed fault plane may be exposed to the sea. The opposite process may occur: a block may be uplifted along a fault plane, exposing a formerly exposed portion of the shoreface to marine erosion. Older cliffs may be raised above sea level and be temporarily protected from further erosion. Earlier shorelines, sometimes tens of meters above the present sea level, are marked by notches or wave-cut platforms (sometimes termed uplifted marine terraces) (Figure 3-10). Uplifted terraces, marking the highstand of eustatic (absolute) sea level, have been traced around the world. Deep water is often found immediately offshore of faulted coasts. Cliffs that extend steeply into deep water are known as plunging cliffs.

d. *Erosional coasts* may be straight or may be irregular, with deeply indented bays. The way the shore reacts to inundation and subsequent marine erosion depends on both the wave climate and the rock type.

(1) *Wave-straightened coasts*. Cliffs are often found along shores where wave erosion rather than deposition is the dominant coastal process. Exposed bedrock, high relief, steep slopes, and deep water are typical features of erosional shorelines (de Blij and Muller 1993). When islands are present, they are likely to be remnants of the retreating coast rather than sandy accumulations being deposited in shallow water. The sequence of events that creates a straightened coast is illustrated in Figure 3-11. The original coastline includes headlands and embayments (a). As waves attack the shore, the headlands are eroded, producing steep sea cliffs (b). The waves vigorously attack the portion of the cliff near sea level, where joints, fissures, and softer strata are especially vulnerable. The cliffs are undermined and caves are formed. Pocket beaches may accumulate between headlands from sediment carried by longshore currents. Especially durable pinnacles of rock may survive offshore as stacks or

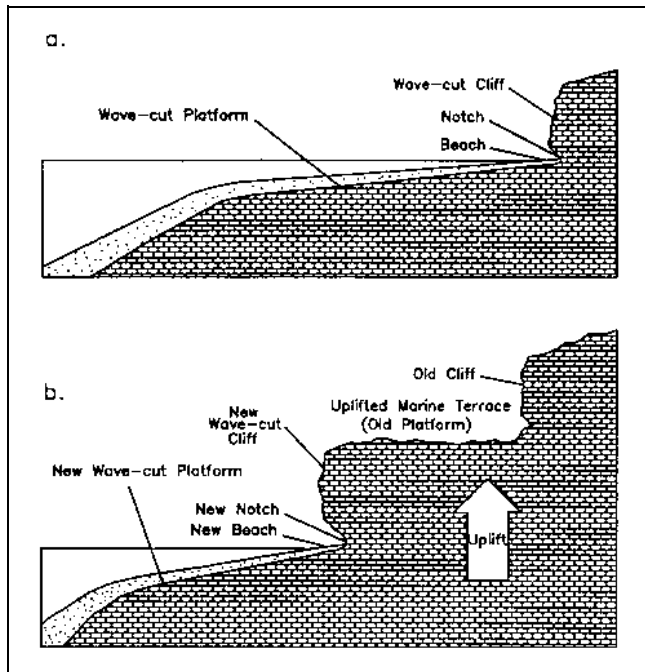

Figure 3-10. Wave-cut platform exposed by tectonic uplift

arches. Over time, the coast is straightened as the headlands are eroded back (c).

(a) Beaches. Beaches may form at the base of cliffs if the rubble which has fallen from the cliff face (known as talus) is unconsolidated or friable and breaks down rapidly under wave attack. If the rock debris is durable, it may serve to armor the shore, protecting it from further wave attack except during the most severe storms.

(b) Wave-cut platforms. At the base of cliffs that have been progressively cut back by waves, near-horizontal platforms may form just below sea level. These rocky platforms may be of substantial width, depending on lithology and the time that sea level has been at that height (Figure 3-10). The platforms may be clean or may be covered with rubble fallen from the adjacent cliffs.

(2) Creation of irregular shorelines. In some mountainous terrains, rising sea level results in deeply incised coastlines. This process is illustrated in Figure 3-12. As the sea rises, a river valley is inundated. Once exposed to the sea, the new shoreline is subject to dissolution and biological attack. In southern France, Italy, Greece, and Turkey, thousands of deep embayments are found in the coastal limestone hills. The fact that the wave climate in the Mediterranean is relatively calm (compared to the

open oceans) indicates that erosional processes other than wave attack have been instrumental in creating these steep, indented shores. An irregular shore may also be formed when differing rock types outcrop at the coast. Massive rocks, especially igneous and metamorphic ones, withstand erosion better than most sedimentary rocks, which usually are friable and contain bedding planes and fractures. The coasts of Oregon and Washington are very irregular because of the complex geology and variety of exposed rock formations.

e. Mechanisms of cliff erosion. Marine cliffs are degraded by many physical and biological factors.

(1) Wave attack is most likely the primary mechanism which causes cliffs to erode (Komar 1976). The hydraulic pressure exerted by wave impact reaches immense values, causing the rock to fracture. Sand and rock fragments hurled at the cliff by waves grind away at the surface. Komar (1976) states that wave erosion occurs chiefly during storms, but admits that little actual quantitative research has been conducted. Once a cliff has been undercut at its base, the overlying rock, left unsupported, may collapse and slide down to the shoreline (Figure 3-13). Temporarily, the talus protects the cliff, but over time the rubble is reduced and carried away, leaving the fresh cliff face exposed to renewed wave attack.

(2) In addition to waves, weathering processes weaken and crumble sea cliffs. Ice wedging in cold climates progressively weakens the rock. Plant roots grow and expand in cracks. Lichens secrete acids that etch the rock surface. Groundwater can lubricate impermeable rock surfaces, upon which large masses of overlying rock can slip. This process is responsible for large slumps in the shale bluffs along southern Lake Erie.

(3) Mollusks and burrowing animals can weaken otherwise resistant massive rocks. Komar (1976) lists burrowing mollusks such as *Pholadidae* and *Lithophaga*, and periwinkles, worms, barnacles, sponges, and sea urchins as having been observed to erode rock. Boring algae can also weaken rock.

(4) Under normal circumstances, surface seawater is saturated with calcium carbonate (CaCO_3), therefore minimizing dissolution of limestone or CaCO_3 -cemented sediments. Marine organisms can locally increase the acidity of the water in high-tide rock basins and other protected locations. Small pockets found at water's edge, often housing periwinkles and other animals, may have been caused by biochemical leaching (Figure 3-14).

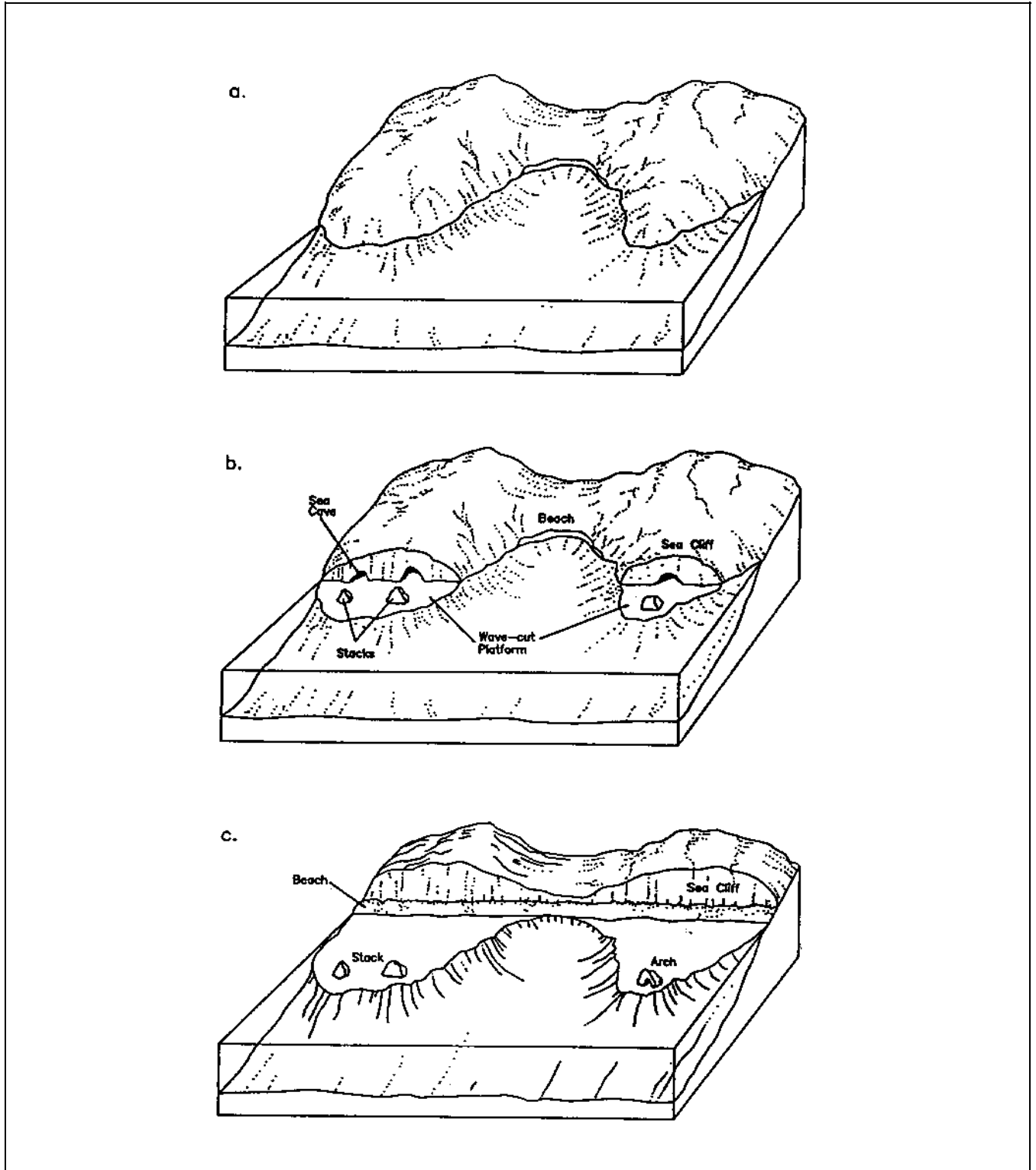

Figure 3-11. Wave erosion of an indented coastline produces a straightened, cliff-bound coast. Wave-cut platforms and isolated stacks and arches may be left offshore (adapted from de Blij and Muller (1993))

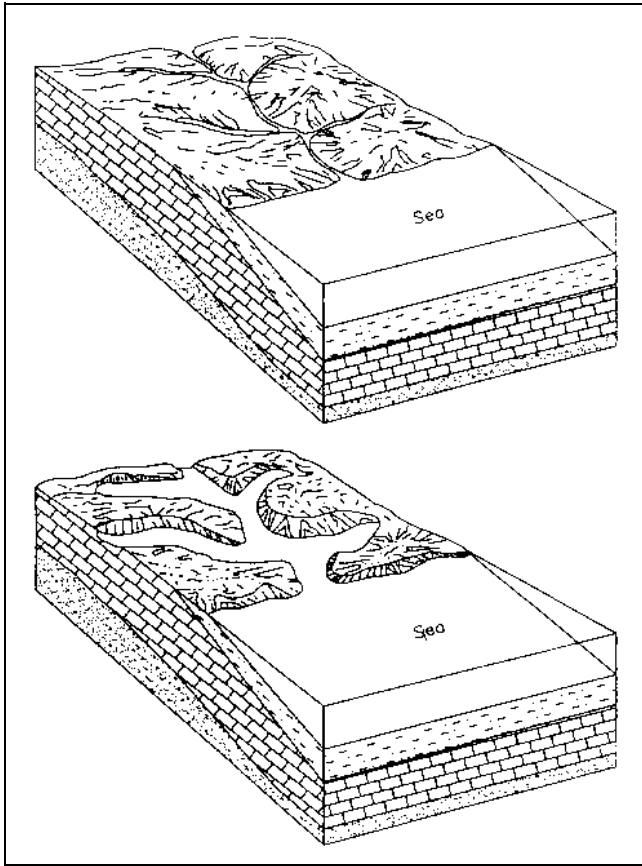

Figure 3-12. Inundation of a mountainous area by rising sea level or land subsidence produces a deeply indented shoreline

(5) Salt weathering is caused by the pressure exerted by NaCl and other salts in the capillaries of rocks. The weathering is caused by:

- Changes of volume induced by hydration.
- Expansion of salt crystals caused by temperature changes.
- Crystal growth from solution.

The main factor in determining the efficacy of chemical weathering is the amount of water available for chemical reactions and the removal of soluble products. This suggests, but does not necessarily restrict, that the greatest chemical weathering will occur in hot, humid climates (Trenhaile 1987).

3-9. Marine Deposition Coasts - Barriers

a. Introduction. Barriers are broadly defined as narrow, elongate sand ridges rising slightly above the high tide level and extending generally parallel with the coast, but separated from the mainland by a lagoon or marsh (Bates and Jackson 1984). The term *barrier* identifies the sand ridges as ones that protect parts of the coast that are further landward from the direct wave attack of the open ocean. For the purpose of this manual, barrier will refer to the overall structure (sometimes called a barrier complex) which includes the beach, submerged nearshore features, underlying sediments, and the lagoon that separates the barrier from the mainland (Figure 3-15). Inlets and channels can also be considered part of a barrier system.

The term *beach* is sometimes used as a synonym for barrier, but this can lead to confusion because a beach is a geomorphic shore type that is found throughout the world, even on volcanic or coralline coastlines, where barriers are rare. Whereas all barriers include beaches, not all beaches are barriers.

The following sections will describe general barrier island morphology, history, and formation, subjects that have fascinated geologists for over 100 years. The emphasis will be on long-term changes, covering periods of years or centuries. The purpose is to explain factors that lead to barrier migration or evolution. Longshore sediment transport, details on the morphology of sandy shorefaces, and the normal effects of waves and tides will be covered in Chapter 4, "Coastal Morphodynamics." This distinction is somewhat arbitrary because, clearly, the day-to-day processes that affect beaches also influence barrier development. In addition, the evolution of barriers during the Holocene Epoch is intimately related to sea level changes (discussed in Chapter 2). These factors underscore the complex interrelationships which exist throughout the coastal zone and the difficulty of separating the constituent elements.

The long-term and widespread interest in barrier islands is largely due to their great economic importance. Ancient buried barriers are important petroleum reservoirs. Contemporary barriers protect lagoons and estuaries, which are the breeding ground for numerous marine species and birds. In addition, barrier islands are among the most important recreational and residential shorelines. In



Figure 3-13. A section of a cliff, projecting out from the shore, is likely to collapse soon. To the left, rubble at sea level marks the location of a previous slump. The lower cliffs are poorly cemented conglomerate while the higher, vertical, cliffs are limestone (near Nauplió, Greece)

recent years, man's adverse impact on these fragile ecological and geological environments has led to increased need to study their origins and development in order to improve coastal management and preserve these critical resources for the future.

An enormous literature on barrier islands exists. Nummedal (1983) provides a readable and concise overview. Leatherman's (1979) book is a compilation of papers on U.S. East Coast and Gulf of Mexico barriers. Many of the seminal papers on barrier island evolution have been reprinted in Schwartz (1973). Textbooks by Carter (1988), Davis (1985), King (1972), and Komar (1976) discuss barriers and include voluminous reference lists. Classic papers on beach processes have been reprinted in Fisher and Dolan (1977).

b. Distribution of barrier coasts. Barrier islands are found around the world (Table 3-2). Barrier island coastlines are most common on the trailing edges of the

migrating continental plates (Inman and Nordstrom 1971)¹. This type of plate boundary is usually non-mountainous, with wide continental shelves and coastal plains. Over 17 percent of the North American coastline is barrier, most of it extending along the eastern seaboard of the United States and along the northern and western Gulf of Mexico. Extensive barriers are also found on the Gulf of Alaska north of Bering Strait. More limited

¹The trailing edge of a continent is moving away from an active spreading center. For example, the Atlantic coast of the United States is a trailing edge because new sea-floor is being formed along the mid-Atlantic ridge, causing the Atlantic Ocean to grow wider (Figure 2-2). The Pacific coast is a leading edge because the oceanic plates to which the continent is attached are being subducted (consumed) at various trenches and are therefore becoming smaller.

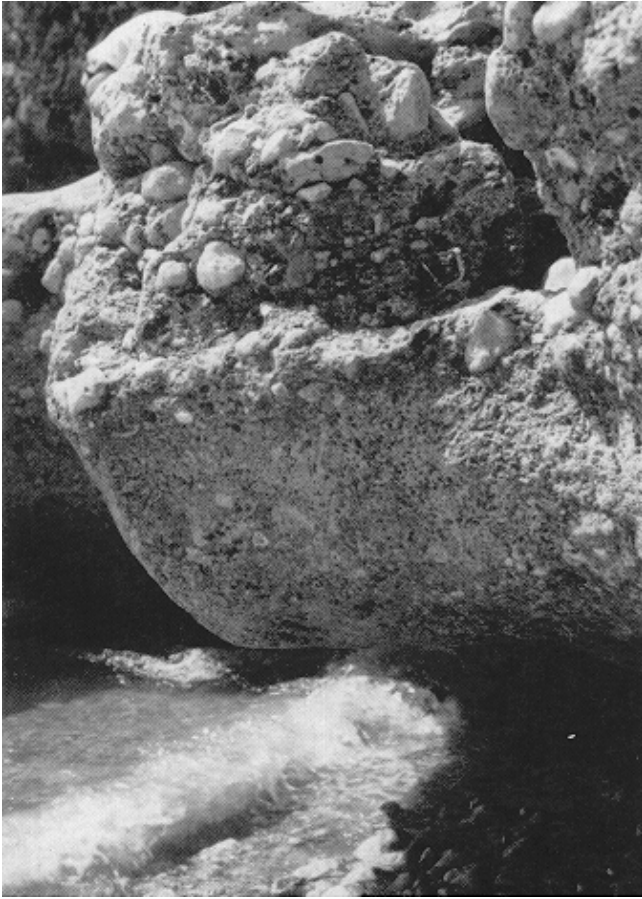

Figure 3-14. Cemented conglomerate with many pits and cavities shows evidence of dissolution. The rock mass has been undercut over 1 m (near Nauplió, Greece)

examples are found in northwest Oregon and southwest Washington and the Great Lakes.

c. General coastal barrier structure. The barrier shore type covers a broad range of sizes and variations. Three general classes of barrier structures can be identified (Figure 3-16):

(1) Bay barriers - connected to headlands at both ends and enclosing a bay or wetland.

(2) Spits - attached to a sediment source and growing downdrift. May be converted to a barrier island if a storm cuts an inlet across the spit. May become bay barriers if they attach to another headland and completely enclose a lagoon.

(3) Barrier islands - linear islands that are not attached to the mainland. A series of these islands extending along the coast are a barrier chain.

d. Origin and evolution. The origin of barrier islands has been a topic of debate amongst geologists for over a century (Schwartz 1973). The differing theories suggest that there are probably several types of barrier, each one undergoing its own form of development due to unique physical and geologic factors. Three main theories have evolved, all of which have fierce supporters and critics.

(1) Emergence model. De Beaumont in 1845 was the first naturalist to formally present a theory of barrier island formation. It was supported and modified by the influential Johnson (1919). These researchers theorized that barrier emergence began with the formation of an offshore sand shoal, which consisted of material reworked from the seafloor by waves. Over time, the shoal would accumulate more and more sand and grow vertically, eventually emerging above the sea surface (Figure 3-17). Wave swash and wind deposition would continue to contribute sand to the shoal, allowing it to grow larger and larger. Hoyt (1967) objected to this hypothesis because he was unaware of any examples of bars emerging above water and surviving wave action, although the growth of submerged bars was well-recorded. Otvos (1970) reported evidence from the Gulf coast supporting the emergence of submarine shoals (he conveniently noted that subsequent migration of barriers might completely obscure the conditions of formation of the original barrier).

(2) Submergence model. The submergence concept was refined by Hoyt (1967) and has received much support. In this model, the initial physical setting is a mainland beach and dune complex with a marsh separating the beach from higher terrain inland. Rising sea level floods the marsh, creating a lagoon that separates the beach from the mainland (Figure 3-18). Presumably, in most cases the sea level rise is part of a worldwide pattern (eustatic), but it may be caused in part by local submergence. Once formed, maintenance of the barrier becomes a balance of sediment supply, rate of submergence, and hydrodynamic factors.

(3) Spit detachment model. The third major model calls for the growth of sand spits as a result of erosion of headlands and longshore sediment transport (Figure 3-19). Periodically, the spit may be breached during storms. The furthest portion of the spit then becomes a detached barrier island, separated by a tidal inlet from the portion that

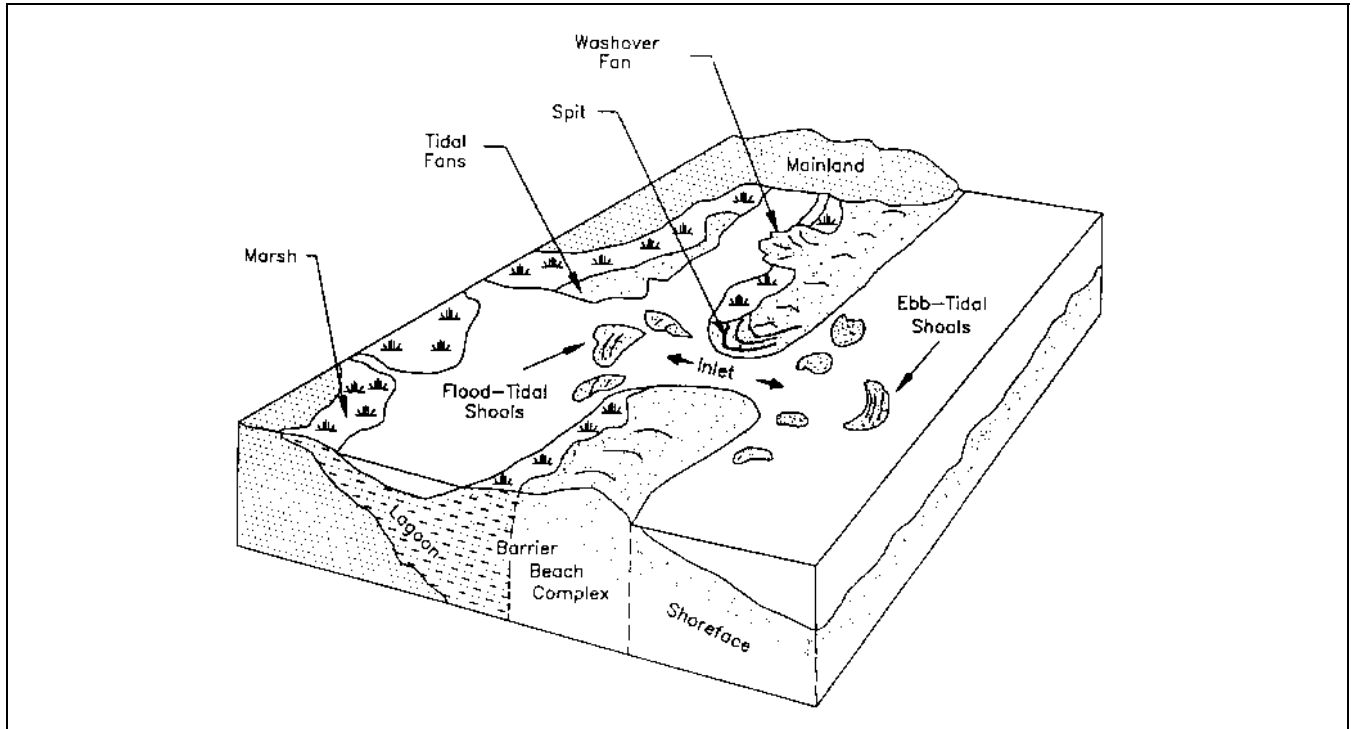

Figure 3-15. A three-dimensional view of features commonly associated with barrier island systems, including the back barrier, overwash fans, and lagoons

Table 3-2
Worldwide Distribution of Barrier Island Coasts

Continent	Barrier Length (km)	% of World Total Barriers	% of Continent's Coastline that is Barrier
N. America	10,765	33.6	17.6
Europe	2,693	8.4	5.3
S. America	3,302	10.3	12.2
Africa	5,984	18.7	17.9
Australia	2,168	6.8	11.4
Asia	7,126	22.2	13.8
Total	32,038	100.0	

From: Cromwell (1971)

is still attached to the mainland. Gilbert (1885) may have been the first geologist to suggest the spit hypothesis, based on his studies of ancient Lake Bonneville, but the hypothesis lay dormant for many years because of Johnson's (1919) objections. In recent years, it has received renewed support because the cycle of spit growth and breaching can be seen in many locations (for example, at Cape Cod, Massachusetts (Giese 1988)).

(4) Combined origin model. Schwartz (1971) concluded that barrier island formation is most probably a combination of all of the above mechanisms. He felt that there were only a few examples of barriers that could be cited as having been formed by only one method. Most systems were much more complex, as demonstrated by the barriers of southern Louisiana, which were formed by a combination of submergence and spit detachment (Penland and Boyd 1981).

e. Barrier response to rising sea level. Many of the barriers in the United States, particularly along the Atlantic coast, are eroding, causing tremendous economic and management difficulties along developed shores. What factors are responsible for this erosion?

Sea level and sediment availability are probably the major factors that determine barrier evolution (Carter 1988). Three sea level conditions are possible: rising, falling, and stationary. Rising and falling sea result in massive sediment transportation; a stationary stage allows the shore to adjust and achieve equilibrium between sediment supply and dynamic processes. In most cases, if sea level rises and sediment supply is constant, a barrier is likely to

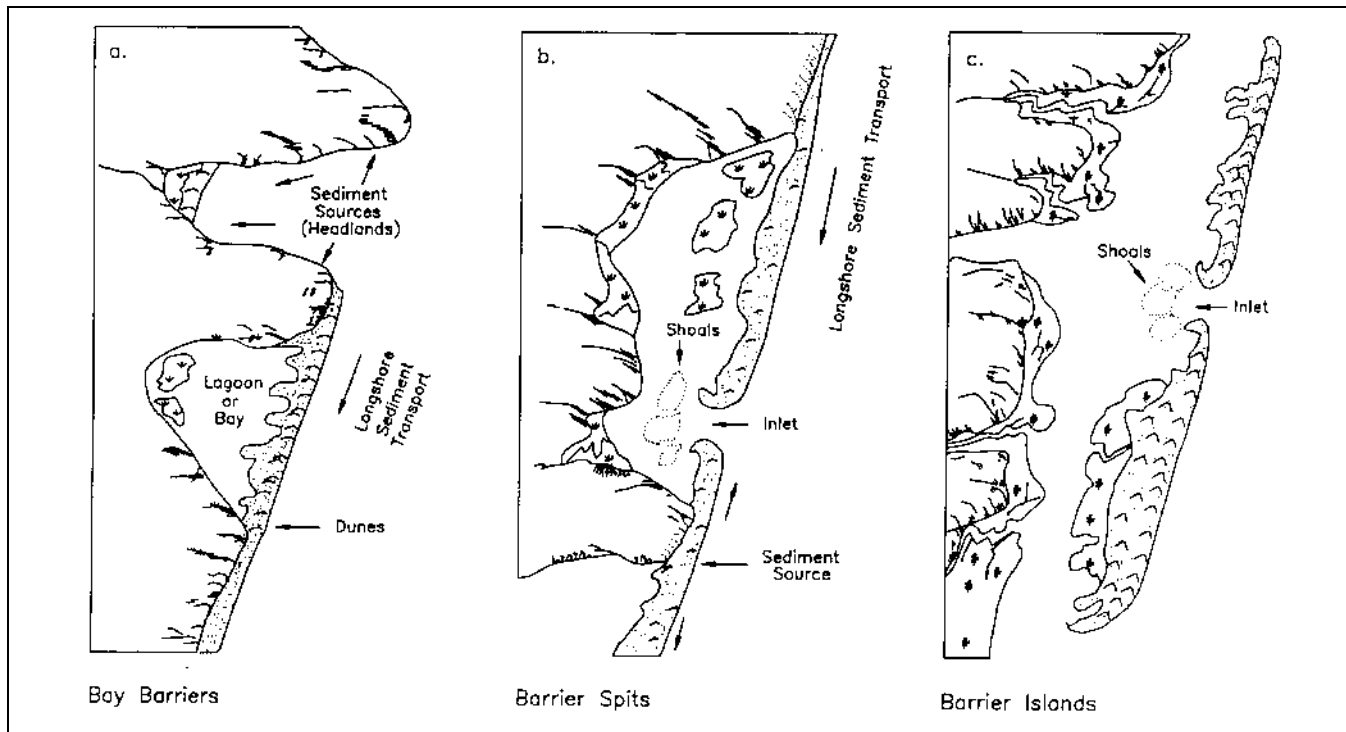

Figure 3-16. General barrier types: bay, spit, island

retreat (*transgression* of the sea). On the other hand, if sea level is rising but a large amount of sediment is supplied locally by rivers or eroding headlands, a particular barrier may be stable or may even aggrade upwards. However, many other factors can intervene: local geological conditions, biological activity, susceptibility to erosion, the rate of sea level change. Therefore, each location must be evaluated individually.

Given the condition of rising sea level along the eastern United States, what are the mechanisms that cause barrier retreat? Three models of shoreline response to rising sea level have been developed (Figure 3-20). These assume that an equilibrium profile is maintained as the shoreline is displaced landward and upward. In addition, overall sediment budget is balanced and energy input is constant.

(1) The first model, often called the Bruun Rule (Bruun 1962), assumes that sediment eroded from the shoreface is dispersed offshore. As water level rises, waves erode the upper beach, causing the shoreline to recede. Conceptually, this supplies sediment for upward building of the outer part of the profile. If it is assumed that the initial profile shape will be reestablished farther inland but at a height above the original position equal to the rise in water level z , then the retreat of the profile x can be calculated from the simple relationship:

$$x = \frac{zX}{Z}$$

where the terms x , z , X , and Z are shown in Figure 3-20a. Attempts to verify the Bruun rule have been ambiguous, and modifications to the model have been proposed (Dolan and Hayden 1983). The most successful studies have required long-term data sets, such as the profiles from Lake Michigan examined by Hands (1983). This research indicates that the shoreface profile requires a considerable time (years or decades) to adjust to water level changes. It is unclear whether the Bruun Rule would apply if an ample supply of sediment were available during rising sea level. Would the barrier essentially remain in place while sand eroded from the shoreface or newly supplied sand was dispersed offshore to maintain the profile? The Bruun Rule is discussed in greater detail in Chapter 4.

(2) Landward migration of a barrier by the rollover model applies to coasts where washover processes are important. As sea level rises, material is progressively stripped from the beach and shoreface and carried over the barrier crest by waves. The sand is deposited in the lagoon or marsh behind the barrier. Dillon (1970) documented this process along the southern Rhode Island

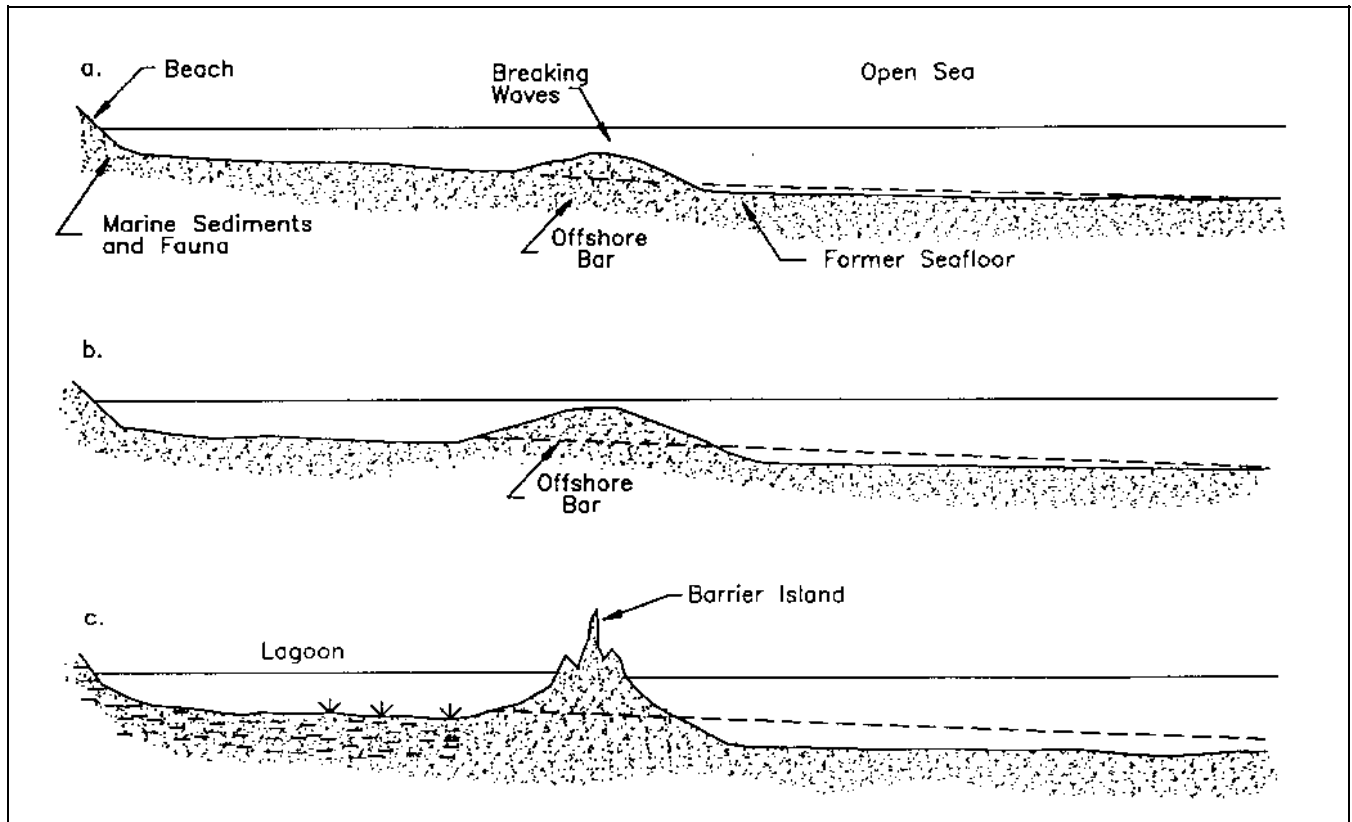

Figure 3-17. Emergence model of barrier island formation (modified from Hoyt (1967)). a. Waves erode seafloor, forming a sandbar; b. Bar continues to grow higher and wider; c. Bar is converted to an island, enclosing a lagoon on the landward side

coast. As the barrier moves landward (rolls over itself), lagoonal sediments may eventually be exposed on open shoreface. Evidence of this can be seen in Rhode Island during winter storms, when large pieces of peat are thrown up on the beach. Dingler, Reiss, and Plant (1993) have described a model of beach erosion and overwash deposition on the Isles Dernieres, off southern Louisiana. They attributed a net annual beach retreat of greater than 10 m/yr to winter cold-front-driven storms that removed sediment from the beach face and infrequent hurricanes that shifted a substantial quantity of sediment to the back-shore. For the most part, rollover is a one-way process because little of the sand carried over the barrier into the lagoon is returned to the open shoreface.

(3) The barrier overstepping model suggests that a barrier may be drowned, remaining in place as sea level rises above it. Several hypotheses have been proposed to explain how this process might occur:

(a) If the rate of sea level rise accelerates, the barrier may be unable to respond quickly by means of rollover or

other mechanisms. Carter (1988) cites research which suggests that gravel or boulder barriers are the most likely to be stranded.

(b) A modest influx of sediment may retard barrier migration enough to allow overstepping. If a constant volume of sediment is available, the new material must be distributed over a wider and wider base as sea level rises. The result is that vertical accretion per unit time decreases. Eventually, the barrier is overtopped and the surf zone moves forward.

(c) A barrier may remain in place because of a dynamic equilibrium that develops between landward and seaward sediment transport. As sea level rises, tidal prism of the lagoon increases, resulting in more efficient ebb transport. During this time, an increasing amount of washover occurs, but the effect is counteracted because sediment is being returned to the exposed shoreface. If little or no new sediment is added to the system, the sea eventually rises above the barrier crest, allowing the surf

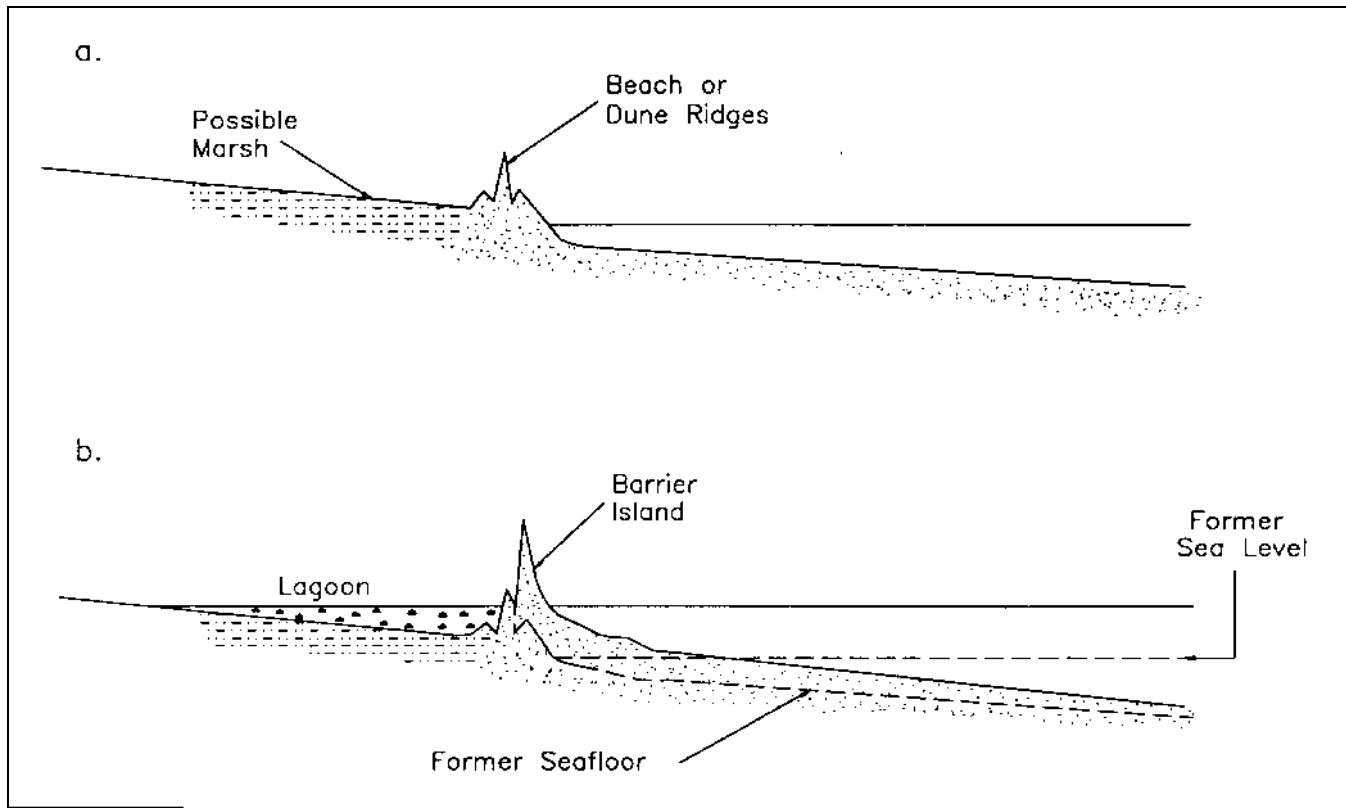

Figure 3-18. Submergence model of barrier island formation (modified from Hoyt (1967)). a. Beach or sand dune ridges form near the shoreline; b. Rising sea level floods the area landward of the ridge, forming a barrier island and lagoon

zone to jump landward to a new location (the formerly protected mainland shore).

(d) All three of these mechanisms may come into play at various times, depending upon environmental conditions. Sediment supply may be the crucial factor, however. Some stranded barriers, such as the ones in the northeastern Gulf of Mexico, appear to have been able to maintain vertical growth because of an adequate sediment supply (Otvos 1981).

(4) In all likelihood, barriers respond to all three of the migration models, depending upon timing and local conditions such as sediment supply or preexisting topography (Carter 1988). During the initial stages of sea level rise, the shore erodes and material is dispersed offshore (the Bruun Rule). As the barrier becomes narrower, washover carries more and more sediment to the back lagoon. Eventually, the barrier may become stranded and be drowned. The models have been criticized because they are two-dimensional and do not account for variations in longshore drift. The criticism is valid because drift is sure to vary greatly as barriers are progressively

reshaped or drowned. The result might be pockets of temporarily prograding barriers along a generally retreating coastline.

(5) In summary, several models have been advanced to explain how barrier islands respond to rising sea level. However, because the interactions in the coastal zone are so complex, it is unrealistic to try to reduce barrier evolution to a series of simple scenarios. Much more research is needed to define the many factors which contribute to barrier evolution.

3-10. Marine Deposition Coasts - Beaches

Marine and lacustrine beaches comprise one of the most widely distributed coastal geomorphic forms around the world. Their importance as a buffer zone between land and sea, and as a recreational and economic resource, has stimulated studies by earth scientists for well over a century. Although much has been learned about how beaches form and how they are modified, the coastal environment is incredibly complex and each location responds to

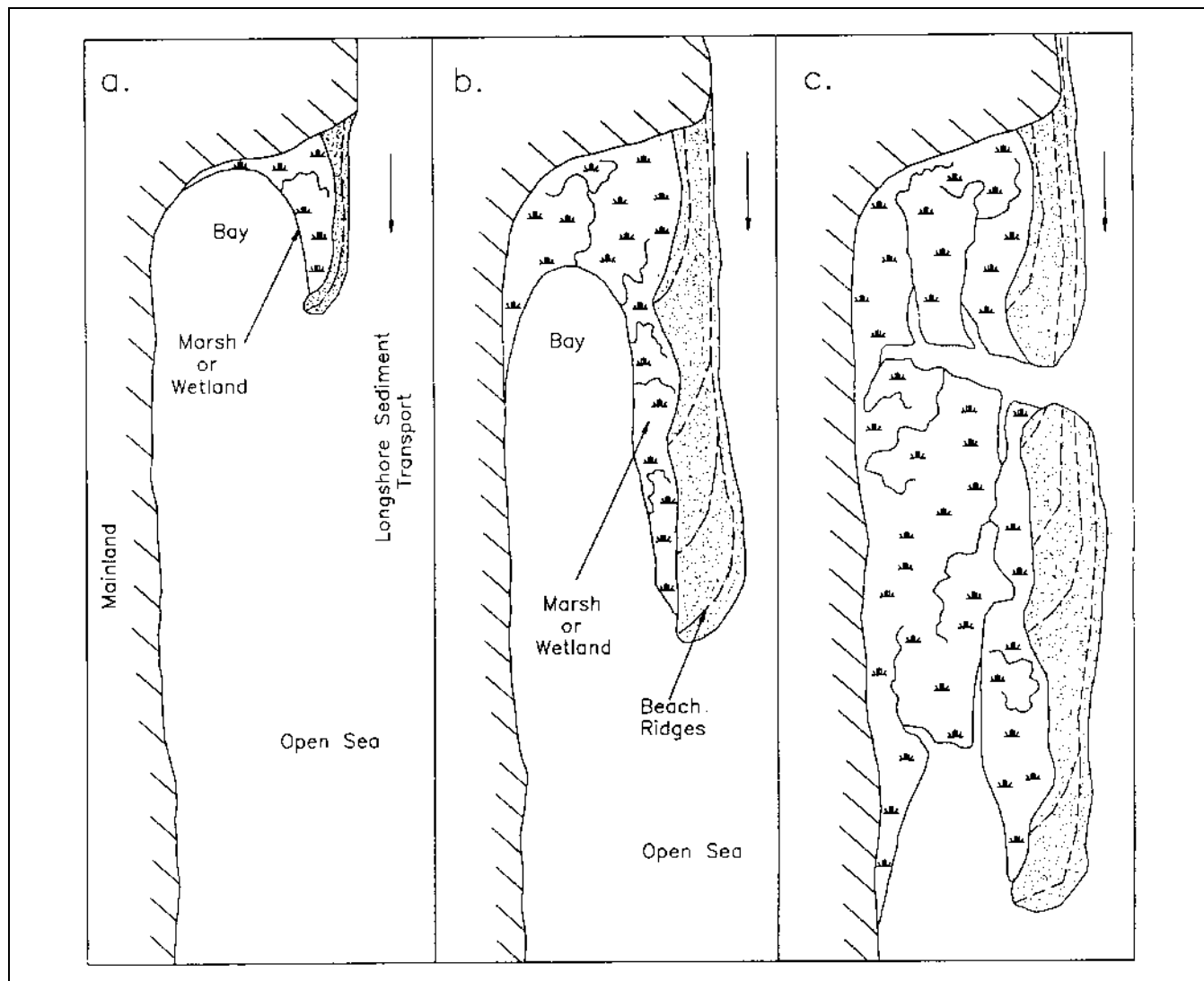

Figure 3-19. Barrier island formation from spit (modified from Hoyt (1967)). a. Spit grows in direction of longshore drift, supplied from headland; b. Spit continues to grow down-drift, marsh begins to fill semi-protected bay; c. Part of spit is breached, converting it to a barrier island

unique geologic conditions and physical processes. Some of these variable factors include:

- Seasonal cycles.
- Long-term trends.
- Changes in relative sea level.
- Variations in sediment supply.
- Meteorological cycles.

As a result, it is difficult to characterize beaches and predict future developments without the benefit of long-term studies and observations. The following sections describe the morphology and sediments of beaches and define terms. For additional information, including extensive bibliographies, the reader is referred to Carter (1988); Davis (1985); Komar (1976, 1983); and Schwartz (1973, 1982).

a. General. Beach is defined as a gently-sloping accumulation of unconsolidated sediment at the edge of a sea or other large body of water (including lakes and

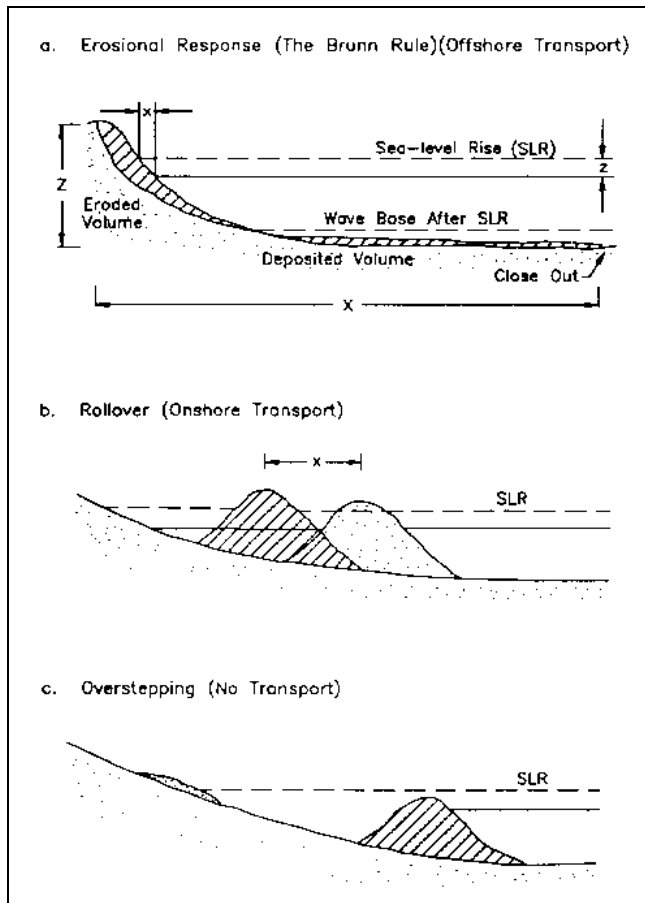

Figure 3-20. Three models of shoreline response to sea level rise: a. Erosional response model/Brunn Rule assumes offshore dispersal of eroded shoreline materials; b. Island rollover model assumes barrier migrates landward according to the rate of sea level rise; c. Overstepping model assumes submergence in place. (Figure adapted from Carter (1988))

ivers). The landward limit may be marked by an abrupt change in slope where the beach meets another geomorphic feature such as a cliff or dune. Although this landward boundary has been consistently accepted in the literature, the seaward limit has been more broadly interpreted. Some authors have included the surf zone and the bar and trough topography in their definition because the processes which occur in the surf zone directly affect the exposed portion of the beach. The length of beaches varies greatly. Some stretch for hundreds of kilometers, such as those on the Carolina Outer Banks. Others, called pocket beaches, are restricted by headlands and may be only a few tens of meters long.

b. Nomenclature. Despite many decades of research which have been conducted on beaches, there is no

universally accepted nomenclature describing different zones or subfeatures. In many publications, the meanings of terms are ambiguous or in conflict. To reduce the likelihood of misunderstandings, it is recommended that the user clearly define (using text and figures) how terms are being used.

c. Major subdivisions. Beaches are part of the littoral zone, the dynamic interface between the ocean and the land. The littoral zone is bounded on one side by the landward limit of the beach and extends tens or hundreds of meters seaward to beyond the zone of wave breaking (EM 1110-2-1502). Beaches can be divided into two major zones: the foreshore and the backshore.

(1) Foreshore.

(a) The foreshore extends from the low-water line to the limit of wave uprush at high water (Figure 2-1). The upper portion of the foreshore is a steep slope where the high water uprush occurs. The seaward, lower, portion of the foreshore is sometimes called the *low-water or low-tide terrace*. The terrace often features low, broad ridges separated by shallow troughs, known as ridges and runnels (Figure 3-21). Because the foreshore is frequently subject to wave swash, it tends to have a smoother surface than the backshore. There may be a minor step near the low-water mark, called the *plunge step*. Often, shell or gravel are concentrated at the base of this step, while the sediments to either side are much finer.

(b) The foreshore is sometimes called the *beachface*. However, beachface is also used in a more restricted sense to designate the steepened portion of the upper foreshore where the high-water wave uprush occurs. Therefore, it is recommended that foreshore and beachface not be used synonymously and that beachface be restricted to its upper foreshore definition.

(2) Backshore.

(a) The backshore extends from the limit of high water uprush to the normal landward limit of storm wave effects, usually marked by a foredune, cliff, structure, or seaward extent of permanent vegetation. The backshore is not normally affected by waves on a continuous basis, but only during storms, when high waves and storm surges allow reworking of backshore sediments. Between inundations, the backshore develops a rough surface because of vehicle or animal traffic and the development of wind-blown bed forms. On eroding beaches, there may be no backshore, and the normal high-water uprush may impinge directly on cliffs or structures.



Figure 3-21. Ridge and runnel system, low water terrace, Charlestown Beach, Rhode Island

(b) Alternate terms for backshore are backbeach and berm. “Berm” is a common term because backshore areas are sometimes horizontal and resemble man-made berms. However, many beaches have a sloping backshore that does not resemble a berm, and some have more than one berm, representing the effects of several storms. Thus, berm is not synonymous with backshore, but may be a suitable description for selected areas. The term is sometimes used in beachfill and beach erosion control design.

(3) Coastline (or shoreline). The boundary between the foreshore and backshore, the high water line (hwl), is often defined to be the coastline. This is a practical definition because this land-water interface can be easily recognized in the field and can be approximated on aerial photographs by a change in color or shade of the beach sand (Crowell, Leatherman, and Buckley 1991). In addition, the coastline marked on the topographic sheets (“T-sheets”) typically represents this same hwl, allowing a direct comparison between historic maps and aerial photographs. Some researchers have equated the coastline with the low-water line, but this boundary is not always marked by any evident feature or change in sand color.

In various studies, one can find shoreline defined by almost any level datum. These inconsistencies make it difficult to compare shoreline maps prepared by different surveyors or agencies. A more detailed discussion of hwl identification is presented in Chapter 5.

d. Beach material.

(1) Sand beaches. On most of the coasts of the United States, the predominant beach material is sand (between 0.0625 and 2.0 mm, as defined by the Wentworth classification). Most sand beaches are composed mostly of quartz, with lesser percentages of feldspars, other minerals, and lithic (rock) fragments. Table 3-3 lists beach sediment types and common locations.

(2) Coarse beaches. Coarse beaches contain large amounts of granule-, pebble-, cobble-, and boulder-sized material (larger than 2.0 in the Wentworth classification). These beaches, found in the northeast, in the Great Lakes, and in mountainous reaches of the Pacific coast, occur under conditions where:

- Local streams flow with enough velocity to carry large particles to the shore.
- Coarse material underlies the beach (often found in areas influenced by glaciation).
- Coarse material is exposed in cliffs behind the beach.

The constituent material may be primarily angular rock fragments, especially if the source area, such as a cliff, is nearby (Figure 3-22). If the source area is far away, the most common rock types are likely to be quartzite or igneous rock fragments because these hard materials have a relatively long life in the turbulent beach environment. Softer rocks, such as limestone or shale, are reduced more

Table 3-3
Types of Beach Sediment

Type	Typical Locations
Quartz sand	East Coast of U.S. between Rhode Island and North Florida, Gulf Coast between West Florida and Mexico, portions of West Coast of U.S. and Great Lakes
Calcite Shell Debris	South Florida, Hawaii
Volcanic Sand	Hawaii, Aleutians, Iceland
Coral Sand	South Florida, Bahamas, Virgin Islands, Pacific Trust Territory
Rock Fragments	Maine, Washington, Oregon, California, Great Lakes
Clay Balls	Great Lakes, Louisiana



Figure 3-22. Shale beach and bluffs, southeast shore of Lake Erie, near Evans, NY

readily to sand-sized particles by abrasion and breakage during their movement to the coast and by subsequent beach processes. Coarse beaches usually have a steeper foreshore than sand beaches.

(3) Biogenic beaches. In tropical areas, organically produced (biogenic) calcium carbonate in the form of skeletal parts of marine plants and animals can be an important or dominant constituent. The more common particles are derived from mollusks, barnacles, calcareous algae, bryozoa, echinoids, coral, foraminifera, and ostacods. The percentage of biogenic material in a beach is a function of the rate of organic production and the amount of terrigenous material being contributed to the shore.

3-11. Salt Marshes

Coastal salt marshes are low-lying meadows of herbaceous plants subject to periodic inundations. During the constructional phase of a coastline, a marsh develops as a result of sediment deposition exceeding sediment removal by waves. Three critical conditions are required for marsh formation. These include abundant sediment supply, low wave energy, and a low surface gradient. Once sediment accumulation reaches a critical height, the mud flats are colonized by halophytic plants that aid in trapping sediment when flooding occurs and add organic material to the substrate.

a. *Classification of Salt Marshes.*

(1) Regional conditions such as temperature, sediment distribution, pH, Eh, and salinity contribute to the zonation of a marsh area. Plant successions, sediment accumulation, and marsh expansion vary but most marshes can be divided into two fundamental zones: low and high. Low marshes are younger, lower topographically, and usually subjected to the adjacent estuarine and marine processes. High marshes are older, occupy a higher topographic position, are more influenced by upland conditions, and are subjected to substantially fewer tidal submersions per year. The boundaries for these zones and their relationship to a given datum may differ from one coast to another. Differences in marsh boundaries seem to be related to tidal regularity and substrate composition. On the Atlantic coast, the tides are generally regular and near equal in semidiurnal range, whereas those on the Pacific coast are markedly unequal in semidiurnal range. Gulf Coast marshes are subjected to irregular and small amplitude tides. Consequently, the demarcation of high and low marshes is not well defined.

(2) Plant structures and animals are significant contributors to sediment accumulation in salt marshes (Howard and Frey 1977). Grasses have a damping effect on wind-generated waves. Stems and levees impede current flow, which helps trap suspended sediment (Deery and Howard 1977). The most obvious mechanism of sediment entrapment is the plant root system. Plant roots may extend more than a meter in depth along Georgia streamside marshes and up to 50 cm in some adjacent habitats (Edwards and Frey 1977).

b. *Sediment characteristics.*

(1) Salt marshes generally contain finer, better sorted sediment than other intertidal environments. However, marsh substrates reflect the local and regional sediment sources. Along the Atlantic coast and shelf of the United States, Hathaway (1972) recognized two distinct clay mineral facies. The northern clay-mineral facies, extending from Maine to Chesapeake Bay, is primarily composed of illite, chlorite, and traces of feldspar and hornblende, whereas the southern clay-mineral facies, which extends from Chesapeake to the south, is composed of chiefly kaolinite and montmorillonite.

(2) Along many northern coasts, peat is an important soil component of marsh substrate. Peat forms from the degradation of roots, stems, or leaves of marsh plants, particularly *Spartina* (Kerwin and Pedigo 1971). In contrast, peat is not a significant component of the southern coastal marshes except in Louisiana and Florida (Kolb and van Lopik 1966). The southern marsh substrate generally consists of silt- and clay-size sediment with a large percentage of carbon material. The major sources of organic carbon in most coastal marshes are in situ plants and animal remains.

(3) Marsh Plants.

(a) Marsh plants are typically tall, salt-tolerant grasses. There are about 20 genera of salt marsh plants worldwide, with the most important North American ones being *Spartina*, *Juncus*, and *Salicornia* (Chapman 1974). Salt marshes are the temperate (and arctic) counterparts of tropical mangrove forests. They generally develop in shallow, low-energy environments where fine-grained sediments are deposited over sandy substrate. As the fine sediments build upward, the marsh plants are able to take root and become established. The established vegetation increases sediment trapping and leads to more rapid upward and outward building of marsh hummocks, which form the foundation of the marsh. The vegetation also

creates lower energy conditions by absorbing wave energy and reducing current velocities, thus allowing accelerated sediment deposition.

(b) Like mangrove forests, many species of invertebrates, fish, birds, and mammals inhabit salt marshes and the adjacent tidal creeks during all or part of their life cycles. Thus, these areas are important to commercial and sport fishermen and hunters. In addition, several marsh species are considered endangered.

(c) Also like mangrove forests, man's main detrimental impact on these marshes has been dredge-and-fill operations for land reclamation and mosquito control. Air and water pollution are also serious problems. Although extensive areas of salt marsh still remain on the east and Gulf coasts of North America, significant amounts have been lost to development. The situation is much worse on the west coast, where most of the coastal marsh lands have been filled and perhaps permanently destroyed. Efforts to restore degraded coastal marshes have not generally been successful.

(4) Sediment Transport and Processes.

(a) Typically, most marshes have very slow rates of sediment accumulation, amounting to only a few millimeters per year (Pethick 1984). Natural and man-induced changes can have deleterious effects on marsh growth. For example, building levees or altering the drainage pattern can result in erosion and permanent marsh loss. Not only is suspended sediment important to vertical growth of the marsh, but biologic components, particularly organic detritus suspended in the water column, are critical to marsh health. The exchange of sediment and nutrients is dependant on the exchange between the local bodies of water.

(b) A marsh sediment budget usually includes consideration of the following factors (Davis 1985):

- Riverine sources.
- Offshore or longshore transport.
- Barrier washover.
- Headlands.
- Eolian transport.
- In situ organic material (i.e. peat, plant detritus, and feces).

- Other terrestrial sources.

(5) Engineering Problems. In light of growing concerns to preserve natural coastal marshes and the need to implement the national policy of "no net wetland losses," many agencies are researching ways to manage and implement wetland technology. Studies have identified numerous man-made and natural causes of wetland loss in the coastal zone:

(a) Sediment deficit. Man-made modifications of natural fluvial systems interfere with natural delta-building processes.

(b) Shoreline erosion. Along many shorelines, the rates of retreat have increased because of hurricanes and other storms, engineering activities along the coast, and boating.

(c) Subsidence. Sinking of the land due to natural compaction of estuarine, lagoonal, and deltaic sediments results in large-scale disappearance of wetlands. This effect is exacerbated in some areas (e.g. Galveston Bay) by subsidence caused by groundwater and oil withdrawal.

(d) Sea level rise. Eustatic sea level rise is partially responsible for increased rates of erosion and wetland loss.

(e) Saltwater intrusion. Increased salinities in wetlands causes the deterioration of vegetation, which makes the wetland more vulnerable to erosion.

(f) Canals. Canals increase saltwater intrusion and disrupt the natural water flow and sediment transport processes.

(6) Marsh Restoration. Many agencies, including the USACE, are conducting research in the building and restoration of marshes, are developing marsh management techniques, and are developing regulatory guidelines to minimize land loss. Under the Wetlands Research Program sponsored by the USACE, new technology in a multi-disciplined approach is being developed. A useful publication is the "Wetlands Research Notebook" (USAEWES 1992), which is a collection of technical notes covering eight field problem areas focusing on wetlands activities in support of USACE civil works projects.

3-12. Biological Coasts

a. Introduction.

(1) On many coasts, such as open wetlands, coral reef, and mangrove forest, biological organisms and processes are of primary importance in shaping the morphology. In contrast, on many other coasts, such as typical sandy beaches, biological activities do not appear to be of major significance when compared to the physical processes at work. Nevertheless, it is important to realize that biological processes are occurring on all shores; all man-made shoreline modifications must address the impact of the modification on the biological community.

(2) The types of organisms that can exist on a coast are ultimately controlled by interrelated physical factors. These include wave climate, temperature, salinity, frequency of storms, light penetration, substrate, tidal range, and the amounts of sediments and nutrients available to the system. Of these, the most important may be wave climate. The amount of wave energy dissipated at a shoreline per unit time ultimately has a dominant influence on whether the substrate is rock, sand, or silt; on the water clarity; on the delivery of nutrients; and, most importantly, on an organism's physical design and lifestyle. The physical forces exerted by a large breaking wave are several orders of magnitude greater than the typical lateral forces affecting organisms in most other environments. For example, mangroves and salt marshes require low wave-energy climates to provide suitable substrate and to keep from being physically destroyed. On the other hand, reef-building corals require reasonably high wave-energy environments to maintain the water clarity, to deliver nutrients, to disperse larvae, to remove sediment, and to limit competition and predation.

(3) Another first order physical condition controlling biological organisms is temperature. For example, this is the primary factor that keeps mangroves and coral reefs confined to the tropics. Also, the formation of ice in coastal waters has a major impact on Arctic communities.

(4) Unlike many physical processes on coastlines, biological processes are generally progradational in nature, extending shorelines seaward. Reef-building organisms produce hard substrate and sediments, in addition to sheltering areas behind the reefs. Some mollusks, calcareous algae (*Hallemeda sp.*, etc.), barnacles, echinoids, bryozoa, and worms produce significant amounts of sediment. Under low energy conditions in the deep sea and sheltered waters, diatoms and radiolaria produce sediments. Mangroves, salt marsh, and dune vegetation trap and stabilize

sediments. The erosional effect of organisms that burrow into sediments or that bore into rocks is usually of lesser importance (erosion of rock coasts is discussed in Section 3-8).

b. *High wave-energy coasts.* Higher plants have not evolved mechanisms to enable them to physically withstand high wave-energy environments. Thus, simple plants, mainly algae, form the bases of the food chains for these marine, coastal communities.

(1) Coral reefs. *Coral reefs* are massive calcareous rock structures that are slowly secreted by simple colonial animals that live as a thin layer on the rock surface. The living organisms continually build new structures on top of old, extending the reefs seaward toward deeper water and upward toward the surface. Reef-building corals have algae living within their tissues in a symbiotic relationship. The algae supplies food to the coral and the coral supplies shelter and metabolic wastes as nutrients to the algae. While some corals are found in temperate and Arctic waters, reef-building corals are limited by water temperature to the tropics, mainly between the latitudes of 30 deg north and south. Bermuda, in the North Atlantic, warmed by the Gulf Stream, is the highest latitude location where active coral reefs are presently found. In the United States, coral reefs are found throughout the Florida Keys and the east and west coasts of Florida, in the Hawaiian Islands, the Pacific Trust Territories, Puerto Rico, and the Virgin Islands.

(a) Reef-building corals require clear water. The corals need to be free of sediments in order to trap food particles, and their algae require sufficient light for photosynthesis. While corals can remove a certain amount of sediment from their upper surfaces, heavy amounts of siltation will bury and kill them. Light penetration limits the depth of a majority of the reef-building corals to the upper 30-50 m, though some corals grow much deeper. The upper limit of reef growth is controlled by the level of low tide. Corals cannot stand more than brief exposures out of the water (for example, during the occasional passage of a deep wave trough).

(b) While coral reefs produce rock structure, they also produce calcareous sediments. Waves and currents pulverize coral skeletons into sand-size particles. However, on many reefs, calcareous algae (*Hallemeda sp.*) produce a majority of the sediments. The crushed calcareous shells of other animals, such as mollusks, sea urchins, and sand dollars, also produce sediment.

(c) Coral reefs rival tropical rain forests as being among the most complex communities on earth, and rock-producing reef communities are among the most ancient life forms found in the fossil record. Because of their complexity, the dynamics of coral reefs are not yet well understood. While they are not yet suffering the widespread destruction that tropical rain forests are, coral reefs are being adversely affected by man. Some of the most widespread impacts are water pollution from various human activities, dredge and fill operations, over-harvesting of fish and shellfish, and the harvesting of some corals for jewelry.

(d) Controlled dredging around reefs is possible and is done routinely, causing minimal impact to the reef communities. Mechanical damage (from cutterheads, chains, anchors, and pipelines) is often of equal or greater concern than suspended sediment production. Improvements in navigation and positioning have made dredging rear reefs more viable. Nevertheless, careful monitoring is mandated in most cases.

(e) Reefs are of major economic importance to the communities along which they are located. Spurgeon (1992) classifies their economic benefits as:

- Direct extractive uses - fisheries, building material.
- Direct non-extractive uses - tourism.
- Indirect uses - biological support for a variety of other ecosystems.

(f) Stoddard (1969) has identified four major forms of large-scale coral reef types: fringing reefs; barrier reefs; table reefs; and atolls.

(g) *Fringing reefs* generally consist of three parts: a fore reef, a reef crest, and a back reef. The *fore reef* usually rises steeply from deep water. It may have spur and groove formations of coral ridges interspersed with sand and rubble channels. The *reef crest* usually forms a continuous wall rising to the low tide level. This usually occurs within a few hundred meters from shore. The seaward side of this area, called the *buttress zone*, receives the brunt of the wave action. Between the reef crest (or flat) and the shoreline, the reef usually deepens somewhat in the back reef area. This area typically contains much dead coral as well as rock, rubble, sand, and/or silt. It also contains live coral heads, algae, eel grass, etc. Fringing reefs form as the beginning stages in the evolution of atolls and possibly barrier reefs.

(h) *Barrier reefs* grow on the continental shelf where suitable solid substrate exists to serve as a foundation. Their form is typically a long coral embankment separated from the mainland by a lagoon that may be several kilometers wide. The lagoon is usually flat-floored and may be as much as 16 km wide and 35 to 75 m in depth. Although similar to fringing reefs in design, barrier reefs are much more massive, the reef crests are much further from shore, and the back reef areas are deeper. Protected shorelines behind barrier reefs are characterized by mangrove swamps and are usually progradational. The seafloor on the seaward side slopes steeply away into deeper water and is covered by coral rubble.

(i) *Table reefs* form from shallow banks on the seafloor that have been capped with reef-forming organisms. They cover extensive areas of the seafloor and are not associated with the formation of barriers and lagoons.

(j) *Atolls* are ring-shaped reefs that grow around the edges of extinct volcanic islands, enclosing lagoons of open water. The shallow lagoons may contain patch reefs. Atolls are primarily found in isolated groups in the western Pacific Ocean. Small low islands composed of coral sand may form on these reefs. These islands are quite vulnerable to inundation and to tropical storms. The first theory concerning the development of atolls, the subsidence theory proposed by Charles Darwin in 1842, has been shown to be basically correct (Strahler 1971). Figure 3-23 illustrates the developmental evolution of an atoll.

(k) The development of atolls begins with an active volcano rising from the ocean floor and forming a volcanic island. As the volcano ceases activity, a fringing reef forms along the shore. Over geologic time, erosion of the volcanic island and subsidence due to general aging of the ocean basin cause the island to drop below sea level. The actively growing fringing reef keeps pace with the subsidence, building itself upward until a barrier reef and lagoon are formed. As the center of the island becomes submerged, the reef continues its upward growth, forming a lagoon. During the development, the lagoon floor behind the reef accumulates coral rubble and other carbonate sediments, which eventually completely cover the subsiding volcanic island.

(2) Worm reefs. A type of biogenic reef that is not related to coral reefs is that produced by colonies of tube worms. Serpulid worms and Sabellariid worms are two types known to form significant reef structures by constructing external tubes in which they live. The Serpulids

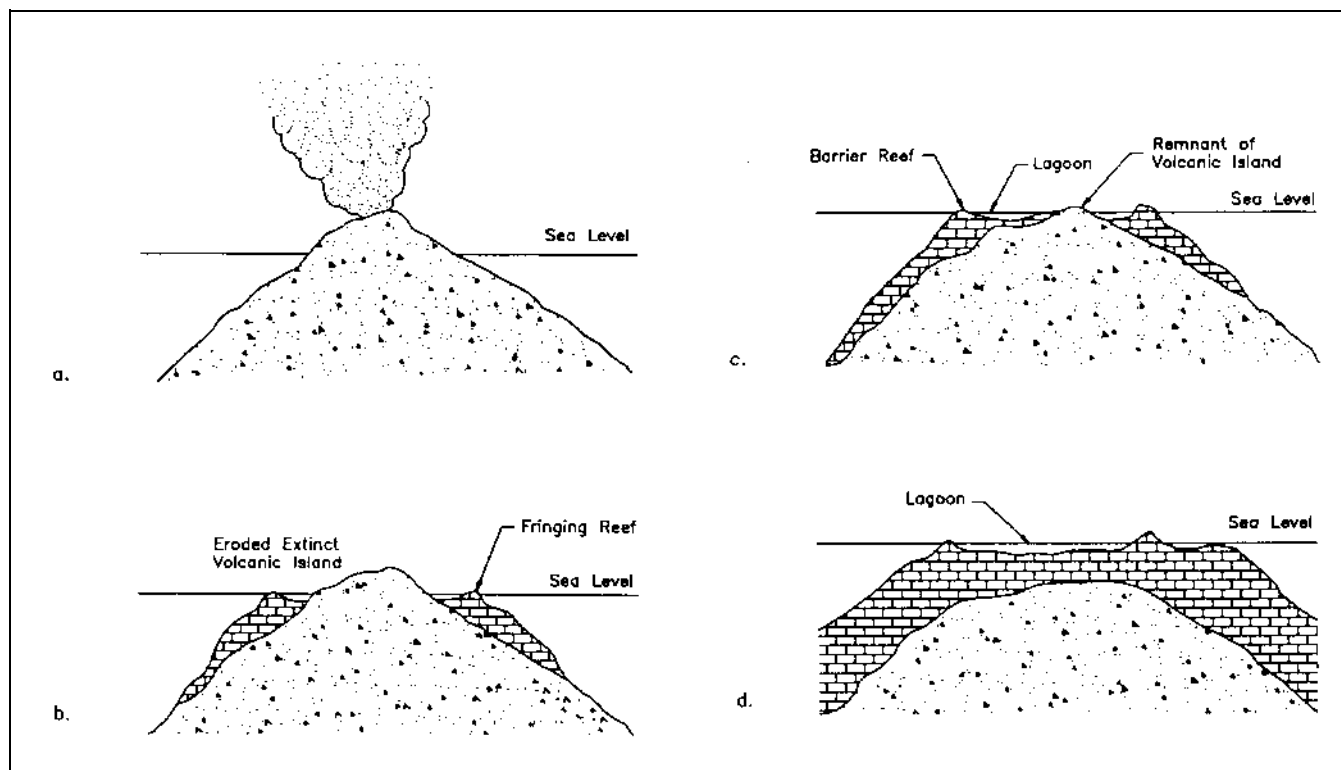

Figure 3-23. Evolution of a coral island: a. Active volcano rising from the seafloor, b. Extinct volcanic island with fringing reef, c. Subsiding island; reef builds upward and seaward, forming barrier reef, d. Continued subsidence causing remnant volcanic island to be completely submerged. Growth continues upward and seaward until remnant volcano is covered (adapted from Press and Siever (1986))

build their tubes from calcareous secretions and the Sabeliariids by cementing particles of sand and shell fragments around their bodies. Colonies of these worms are capable of constructing massive structures by cementing their tubular structures together. As new tubes are continually produced over old ones, a reef is formed. These reefs typically originate from a solid rocky bottom which acts as an anchoring substrate. Worm reefs are most commonly found in sub-tropical and tropical climates (e.g., east coast of Florida). Reefs of this nature can play an important role in coastal stabilization and the prevention of coastal erosion.

(3) Oyster reefs. Oysters flourish under brackish water conditions such as lagoons, bays, and estuaries. The oysters cement their shells to a hard stable substrata including other oyster shells. As new individuals set onto older ones, a reef is formed. These reefs can form in temperate as well as tropic waters.

(a) Oysters found around the United States are part of the family *Ostreidae*. The Eastern, or American oyster (*Crassostrea virginica*) is distributed along the entire east

coast of North America from the Gulf of St. Lawrence through the Gulf of Mexico to the Yucatan and the West Indies. The other major North American species is *Ostrea lurida*, which ranges along the Pacific coast from Alaska to Baja California (Bahr and Lanier 1981).

(b) Intertidal oyster reefs range in size from isolated scattered clumps a meter high to massive solid mounds of living oysters anchored to a dead shell substrate a kilometer across and 100 m thick (Pettijohn 1975). Reefs are limited to the middle portion of the intertidal zone, with maximum elevation based on a minimum inundation time. The uppermost portion of a reef is level, with individual oysters oriented pointing upwards. At the turn of the century, vast oyster flats were found along the Atlantic coast in estuaries and bays. In South Carolina, the flats covered acres and sometimes miles in extent (cited in Bahr and Lanier (1981)).

(c) Oyster reefs serve an important biological role in the coastal environment. The reefs are a crucial habitat for numerous species of microfauna and macrofauna. The rough surface of a reef flat provides a huge surface area

for habitation by epifauna, especially vital in the marsh-estuarine ecosystem that is often devoid of other hard substrate. The high biological productivity of reef environments underscores one of the reasons why reefs must be protected and preserved.

(d) Oyster reefs play important physical and geological roles in coastal dynamics because they are wave-resistant structures that are able to biologically adapt to rising sea level. Reefs affect the hydrologic regime of salt marsh estuaries in three ways: by modifying current velocities, by passively changing sedimentation patterns, and by actively augmenting sedimentation by biodeposition. (Biological aggradation increases the size of suspended particles and increases their settling rates.) As reefs grow upward and laterally, modify energy fluxes by damping waves and currents, and increase sedimentation, they ultimately produce major physiographic changes to their basins. These changes can occur on short time scales, on the order of hundreds of years (Bahr and Lanier 1981). During geologic history, massive reefs have accumulated in many areas, some of which became reservoirs for oil and gas.

(e) Although oysters are adapted to a wide range of temperature, turbidity, and salinity conditions, they are highly susceptible to man-made stresses. These stresses on oyster communities can be classified into eight categories (Bahr and Lanier 1981):

- Physical sedimentation, especially from dredging or boat traffic.
- Salinity changes due to freshwater diversion or local hydrologic alterations.
- Eutrophication (oxygen depletion) due to algae growth in water that is over-enriched with organic matter.
- Toxins from industrial and urban runoff.
- Physical impairment of feeding structures by oil.
- Thermal loading, primarily from power plants.
- Overharvesting.
- Loss of wetlands.

There has been a recorded significant decline in the health of and aerial extent of living U.S. east coast oyster reefs since the 1880's, although the data are sometimes

conflicting, partly because ground-level surveys are difficult to conduct (Bahr and Lanier 1981). It is easy to account for the declines of reefs near population and industrial centers, but the declines are more difficult to explain in more pristine areas of the coast (e.g. the Georgia coast near Sapelo Island). Population changes may be due, in part, to natural cycles of temperature and salinity or fecundity.

(f) Because oyster reefs are susceptible to fouling and silting, it is important that geologists and engineers consider sediment pathways during the planning phases of coastal construction and dredging projects or stream diversion and other watershed changes. As discussed earlier, dredging near reefs is technically feasible as long as careful technique is observed and environmental conditions are monitored.

(g) In summary, oyster reefs serve critical biological and physical purposes in the estuarine and coastal marsh environment. They enhance biological productivity, provide stable islands of hard substrate in otherwise unstable soft muddy bottoms, modify hydrodynamic flows and energy fluxes. With respect to shore protection, reefs are a biological wave damper that can accommodate rising sea level as long as they are alive. It is essential that reefs be protected from wanton destruction by pollution and other stresses imposed by human development.

(4) Rocky coasts.

(a) Kelp beds. Kelp forests are formed by various species of algae which attach to hard substrate with a root-like system called a *holdfast*. Some (prominently *Macrosistus sp.*) can grow many tens of meters in length up to the water surface, where their tops float and continue to grow. The plants are quite rubbery and can withstand significant wave action. Kelp beds are found along rocky shorelines having cool clear water. In North America, they occur along much of the Pacific coast and, to a lesser extent, along the North Atlantic coast. Kelp beds are, to some extent, the functional temperate latitude counterpart of coral reefs (Carter 1988).

(b) Kelp biological communities. Kelp beds harbor extensive biological communities that include fish, sea otters, lobster, starfish, mollusks, abalones, and many other invertebrates. In addition, kelp beds absorb wave energy, helping to shelter beaches. Man's main impact has been the commercial harvesting of various portions of this community, including the kelp. In the past, hunting sea otters for their pelts allowed sea urchins to multiply, and the overpopulation of sea urchins grazed and

destroyed many beds. Today, the reestablishment of some sea otter populations has led to conflicts with shell fishermen. Water pollution is also a problem in some areas.

(c) Rock reefs and shorelines. Submerged rock reefs provide substantial habitat for organisms. They provide a place of attachment for sessile organisms, and the crevices provide living spaces and havens of refuge for mobile organisms such as fish and lobsters. These structures are considered a boon to sports fishermen, and many artificial reefs have been built on sandy seafloors out of a wide array of materials. Rocky shorelines have communities of organisms living in the intertidal and subtidal zones. These may or may not be associated with offshore kelp bed or coral reef communities.

(5) Sandy coasts. Much of the biological activity on sandy coasts is confined to algae, various invertebrates, and fish living within the water column. Of these, fish, shrimp, and crabs have the greatest economic importance. In addition, there are infaunal filter feeders, mainly mollusks and sand dollars, that live just beneath the sand surface.

(a) One important and often overlooked biological activity on some sandy beaches is their use as nesting areas by a variety of migratory animals. These include sea turtles, birds, marine mammals, and fish. In North America, a shocking percentage of these species are threatened or endangered, including all five species of sea turtles and some birds such as the piping plover, the snowy plover, and the least tern. For most of these species, their problems are directly related to conflicts with man's recreational use of beaches and the animals' inability to use alternative nesting sites. Fortunately, some states have implemented serious ecological programs to help save these threatened species. For example, Florida has rigorous laws preventing disruption of nesting turtles, and many Florida municipalities have found that maintaining healthy natural biological communities is an excellent way to lure tourists.

(b) Plants occupying sand dunes are characterized by high salt tolerance and long root systems that are capable of extending down to the freshwater table (Goldsmith 1985). Generally, these plants also generate rhizomes that grow parallel to the beach surface. Beach plants grow mainly in the back beach and dune areas beyond the zone of normal wave uprush. The plants trap sand by producing low energy conditions near the ground where the wind velocity is reduced. The plants continue to grow upward to keep pace with the accumulation of sand although their growth is eventually limited by the inability of the roots

to reach dependable water. The roots also spread and extend downward, producing a thick anchoring system that stabilizes the back beach and dune areas. This stabilization is valuable for the formation of dune systems, which provide storm protection for the entire beach. The most common of these plants are typically marram grass, saltwort, American sea grass, and sea oats. With time, mature dunes may accumulate enough organic nutrients to support shrub and forest vegetation. The barrier islands of the U.S. Atlantic coast and the Great Lakes shores support various species of *Pinus*, sometimes almost to the water's edge.

c. *Low wave-energy coasts.* In locations where the wave climate is sufficiently low, emergent vegetation may grow out into the water. Protection from wave action is typically afforded by local structures, such as headlands, spits, reefs, and barrier islands. Thus, the vegetation is confined to the margins of bays, lagoons, and estuaries. However, in some cases, the protection may be more regional in nature. Some of the mangrove forests in the Everglades (south Florida) and some of the salt marshes in northwest Florida and Louisiana grow straight into the open sea. The same is true for freshwater marshes in bays and river mouths in the Great Lakes.

(1) General.

(a) Only a few higher plants possess a physiology that allows them to grow with their roots in soils that are continuously saturated with salt water. These are the mangroves of the tropics and the salt marsh grasses of the higher latitudes. The inability of other plants to compete or survive in this environment allows small groups of species or single species to cover vast tracts of some coastal areas. These communities typically show zonation with different species dominant at slightly different elevations, which correspond to different amounts of tidal flooding. The seaward limit of these plants is controlled by the need for young plants to have their leaves and branches above water. To this end, some mangroves have seedlings that germinate and begin growing before they drop from the parent tree. Upland from these communities, a somewhat larger number of other plants, such as coconuts and dune grasses, are adapted to live in areas near, but not in, seawater.

(b) Understanding and appreciation of the importance of these types of coastal areas are growing. Former attitudes that these areas were mosquito-infested wastelands imminently suitable for dredge- and-fill type development are being replaced by an appreciation of their great economic importance as nursery grounds for many species of

fish and shellfish, of their ability to remove pollutants, of their ability to protect upland commercial development from storms, of their fragility, and of their beauty.

(2) Mangroves.

(a) *Mangroves* include several species of low trees and shrubs that thrive in the warm, shallow, saltwater environments of the lower latitudes. Worldwide, there are over twenty species of mangroves in at least seven major families (Waisel 1972). Of these, the red, white, and black mangroves are dominant in south Florida and the Caribbean. They favor conditions of tidal submergence, low coastal relief, saline or brackish water, abundant fine sediment supply, and low wave energy. Mangroves have the ability to form unique intertidal forests that are characterized by dense entangled networks of arched roots that facilitate trapping of fine sediments, thereby promoting accretion and the development of marshlands. The *prop roots* and *pneumatophores* also allow the plants to withstand occasional wave action and allow oxygen to reach the roots in anaerobic soils. The prime example in the United States is the southwest shore of Florida, the Everglades National Park.

(b) Mangrove coasts are crucial biological habitats to a wide variety of invertebrates, fish, birds, and mammals. In the past, the primary cause of their destruction has been dredge-and-fill operations for the reclamation of land and for mosquito control.

d. *Other sources of biogenic sediment in the coastal zone.* In areas of high biological activity, organically derived sediments may account for a significant proportion of the sediment composition of an area, especially in areas where terrigenous sediment supplies are low. These sediments, consisting of remains of plants and animals and mineral matter produced by plants and animals, accumulate at beaches, estuaries, and marshlands.

(1) The most familiar types of biogenic sediments are hard calcareous skeletal parts and shell fragments left behind by clams, oysters, mussels, corals, and other organisms that produce calcareous tests. In tropical climates, the sediment commonly consists of coral fragments and calcareous algal remains. Siliceous tests are produced by most diatoms and radiolarians. Sediments predominately containing carbonate or calcareous material are generally referred to as *calcareonites* while sediments composed predominantly of siliceous matter are referred to as *diatomites* or *radiolarites*, depending upon which organism is most responsible for the sediment (Shepard 1973). In the Great Lakes, and some inland

U.S. waterways, the zebra mussel has proliferated since the mid-1980's. Some shorefaces are covered with mussel shell fragments to a depth of over 10 cm. The mussels are a serious economic burden because they choke the inlets for municipal water systems and coolant pipes.

(2) In some areas, wood and other vegetation may be introduced into the sediments in large quantities. This is especially common near large river mouths and estuaries. This organic material may become concentrated in low energy environments such as lakes and salt marshes, eventually producing an earthy, woody composition known as *peat* (Shepard 1973). Peat exposed on the shoreface has been used as an indicator of marine transgression and barrier island retreat (Dillon 1970). In Ireland and Scotland, peat is dried and used as a fuel.

3-13. Continental Shelf Geology and Topography

The geology of the world's continental shelves is of direct significance to coastal engineers and managers in two broad areas. First, the topography of the shelf affects coastal currents and wave climatology. Wave refraction and circulation models must incorporate shelf bathymetry. Bathymetry was incorporated in the wave hindcast models developed by the USACE Wave Information Study (Appendix D). Second, offshore topography and sediment characteristics are of economic importance when offshore sand is mined for beach renourishment or dredged material is disposed offshore. This section reviews the USACE Inner Continental Shelf Sediment and Structure (ICONS) study and describes linear sand ridges of the Mid-Atlantic Bight.

a. *Continental shelf sedimentation studies.* The ICONS study was initiated by the USACE in the early 1960's to map the morphology of the shallow shelf and find sand bodies suitable for beach nourishment. This program led to a greater understanding of shelf characteristics pertaining to the supply of sand for beaches, changes in coastal and shelf morphology, longshore sediment transport, inlet migration and stabilization, and led to a better understanding of the Quaternary shelf history. ICONS reports are listed in Table 3-4.

b. *Continental shelf morphology.* Most continental shelves are covered by sand sheets, the characteristics of which are dependent upon the type of coast (i.e. collision, or leading, versus trailing). Leading edge shelves, such as the Pacific coasts of North and South America, are typically narrow and steep. Submarine canyons, which sometimes cut across the shelves almost to the shore (Shepard 1973), serve as funnels which carry sediment down to the

abyssal plain. Trailing edge shelves are, in contrast, usually wide and flat, and the heads of canyons usually are located a considerable distance from shore. Nevertheless, a large amount of sediment is believed to move down these canyons (Emery 1968).

c. Examples of specific features - Atlantic seaboard.

(1) The continental shelf of the Middle Atlantic Bight of North America, which is covered by a broad sand sheet, is south of the region directly influenced by

Pleistocene glacial scouring and outwash. This sand sheet is divided into broad, flat, plateau-like compartments dissected by shelf valleys that were excavated during the Quaternary lowstands of the sea. Geomorphic features on the shelf include low-stand deltas (cusped deltas), shoal and cape retreat massifs (bodies of sand that formed during a transgressive period), terraces and scarps, cuestas (asymmetric ridges formed by the outcrop of resistant beds), and sand ridges (Figure 3-24) (Swift 1976; Duane et al. 1972).

**Table 3-4
USACE Inner Continental Shelf Sediment and Structure (ICONS) Reports**

Location	Reference ¹
Atlantic Coast	
Massachusetts Bay	Meisburger 1976
New York - Long Island Sound	Williams 1981
New York - Long Island shelf	Williams 1976
New York Bight	Williams and Duane 1974
New Jersey - central	Meisburger and Williams 1982
New Jersey - Cape May	Meisburger and Williams 1980
Delaware, Maryland, Virginia	Field 1979
Chesapeake Bay entrance	Meisburger 1972
North Carolina - Cape Fear	Meisburger 1977; Meisburger 1979
Southeastern U.S. shelf	Pilkey and Field 1972
Florida - Cape Canaveral to Georgia	Meisburger and Field 1975
Florida - Cape Canaveral	Field and Duane 1974
Florida - Palm Beach to Cape Kennedy	Meisburger and Duane 1971
Florida - Miami to Palm Beach	Duane and Meisburger 1969
Gulf of Mexico	
Texas - Galveston County	Williams, Prins, and Meisburger 1979
Lake Erie	
Pennsylvania	Williams and Meisburger 1982
Ohio	Williams et al. 1980; Carter et al. 1982
Lake Michigan	
Southeast shore	Meisburger, Williams, and Prins 1979
Sampling tools and methods	
Pneumatic coring device	Fuller and Meisburger 1982
Vibratory samplers	Meisburger and Williams 1981
Data collection methods	Prins 1980

¹Complete citations are listed in Appendix A

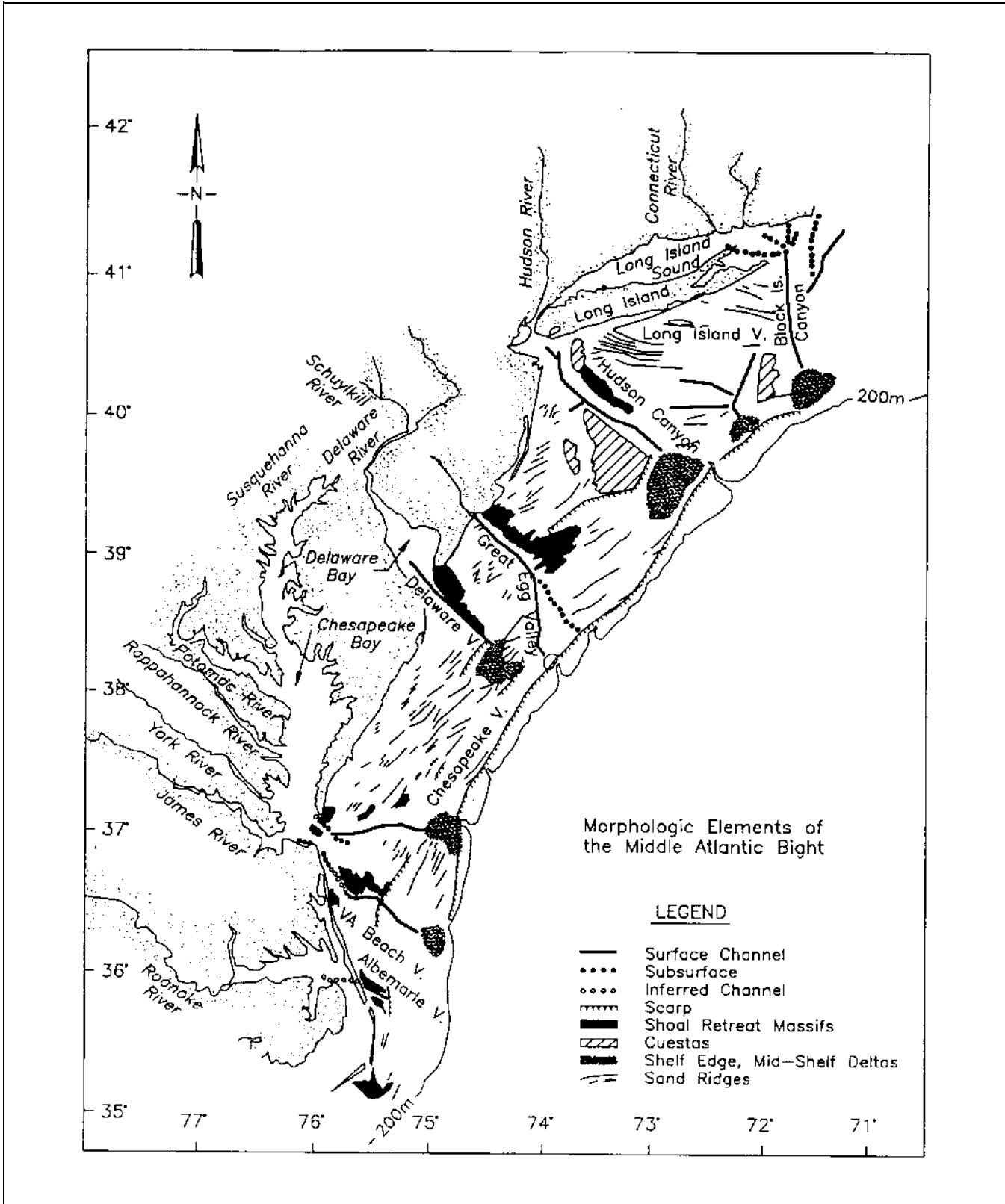

Figure 3-24. Morphology of the Middle Atlantic Bight (from Swift (1976)). Sand ridges close to shore may be suitable sources of sand for beach renourishment

(2) The larger geomorphic features of the Middle Atlantic Bight are constructional features molded into the Holocene sand sheet and altered in response to storm flows. Off the coasts of Delaware, Maryland, and Virginia, shoreface-connected shoals appear to have formed in response to the interaction of south-trending, shore-parallel, wind-generated currents with wave- and storm-generated bottom currents during winter storms. Storm waves aggrade crests, while fair-weather conditions degrade them. A second shoal area further offshore at the 15-m depth is indicative of a stabilized sea level at that elevation. These shoals may be suitable sources of sand for beach renourishment. However, the often harsh wave conditions off the mid-Atlantic seaboard may limit the economic viability of mining these shoals. The origin and distribution of Atlantic inner shelf sand ridges is discussed in McBride and Moslow (1991).

(3) Linear shoals of the Middle Atlantic Bight tend to trend northeast (mean azimuth of 32 deg) and extend from the shoreline at an angle between 5 and 25 deg. Individual ridges range from 30 to 300 m in length, are about 10 m high, and have side slopes of a few degrees. The shoal regions extend for tens of kilometers. The crests

are composed of fine-medium sand while the ridge flanks and troughs are composed of very fine-fine sand. The mineralogy of shoals reflects that of the adjacent beaches.

d. Riverine influence. Rivers provide vast amounts of sediment to the coast. The 28 largest rivers of the world, in terms of drainage area (combined size of upland drainage area and subaerial extent of deltas), discharge across trailing-edge and marginal sea coasts (Inman and Nordstrom 1971). (The Columbia River, which is the 29th largest river in the world, is the largest one to drain across a collision coast). Because the larger rivers drain onto trailing edge coasts, these shores tend to have larger amounts of available sediment, which is deposited across a wide continental shelf. The sediment tends to remain on the shelf and is only lost to the abyssal plains when deltas prograde out across the continental rise (e.g., the Mississippi and Nile Deltas) or when submarine canyons are incised across the shelf (e.g., Hudson River sediment funnels down the Hudson Canyon). On collision coasts, canyons frequently cut across the shelf almost to the shore (Shepard 1973), therefore resulting in the direct loss of sediment from the coastal zone.

Chapter 4 Coastal Morphodynamics

4-1. Introduction

a. This chapter discusses the morphodynamics of four coastal environments: deltas, inlets, sandy shores, and cohesive shores. The divisions are somewhat arbitrary because, in many circumstances, the environments are found together in a limited area. This occurs, for example, within a major river delta like the Mississippi, where a researcher will encounter sandy beaches, bays where cohesive sediments accumulate, and inlets which channel water in and out of the bays.

b. Coastal features and environments are also not isolated in time. For example, as discussed in Chapter 3, estuaries, deltas, and beach ridge shores are elements of a landform continuum that extends over time. Which particular environment or shore type is found at any one time depends on sea level rise, sediment supply, wave and tide energy, underlying geology, climate, rainfall, runoff, and biological productivity.

c. Based on the fact that physical conditions along the coast are constantly changing, it can be argued that there is no such thing as an “equilibrium” state for any coastal form. This is true not only for shoreface profiles but also for deltas, which continue to shift over time in response to varying wave and meteorologic conditions. In addition, man continues to profoundly influence the coastal environment throughout the world, changing natural patterns of runoff and littoral sediment supply and constantly rebuilding and modifying engineering works. This is true even along undeveloped coastlines because of environmental damage such as deforestation, which causes drastic erosion and increased sediment load in rivers. The reader is urged to remember that coastal landforms are the result of the interactions of a myriad of physical processes, man-made influences, global tectonics, local underlying geology, and biology.

4-2. Introduction to Bed Forms

a. Introduction. When sediment is moved by flowing water, the individual grains are usually organized into morphological elements called *bed forms*. These occur in a baffling variety of shapes and scales. Some bed forms are stable only between certain values of flow strength. Often, small bed forms (ripples) are found superimposed on larger forms (dunes), suggesting that the flow field may vary dramatically over time. Bed forms may move

in the same direction as the current flow, may move against the current (antidunes), or may not move at all except under specific circumstances. The study of bed form shape and size is of great value because it can assist in making quantitative estimates of the strength of currents in modern and ancient sediments (Harms 1969; Jopling 1966). Bed form orientations are indicators of flow pathways. This introduction to a complex subject is by necessity greatly condensed. For details on interpretation of surface structures and sediment laminae, readers are referred to textbooks on sedimentology such as Allen (1968, 1984, 1985); Komar (1976); Leeder (1982); Lewis (1984); Middleton (1965); Middleton and Soutard (1984); and Reineck and Singh (1980).

b. Environments. In nature, bed forms are found in three environments of greatly differing characteristics:

- Rivers - unidirectional and channelized; large variety of grain sizes.
- Sandy coastal bays - semi-channelized, unsteady, reversing (tidal) flows.
- Continental shelves - deep, unchannelized; dominated by geostrophic flows, storms, tidal currents, wave-generated currents.

c. Classification. Because of the diverse natural settings and the differing disciplines of researchers who have studied sedimentology, the classification and nomenclature of bed forms have been confusing and contradictory. The following classification scheme, proposed by the Society for Sedimentary Geology (SEPM) Bed forms and Bedding Structures Research Group in 1987 (Ashley 1990) is suitable for all subaqueous bed forms:

d. Ripples. These are small bed forms with crest-to-crest spacing less than about 0.6 m and height less than about 0.03 m. It is generally agreed that ripples occur as assemblages of individuals similar in shape and scale. On the basis of crestline trace, Allen (1968) distinguished five basic patterns of ripples: straight, sinuous, catenary, linguoid, and lunate (Figure 4-1). The straight and sinuous forms may be symmetrical in cross section if subject to primarily oscillatory motion (waves) or may be asymmetrical if influenced by unidirectional flow (rivers or tidal currents). Ripples form a population distinct from larger-scale dunes, although the two forms share a similar geometry. The division between the two populations is caused by the interaction of ripple morphology and bed, and may be shear stress. At low shear stresses, ripples are formed. As shear stress increases above a certain threshold a

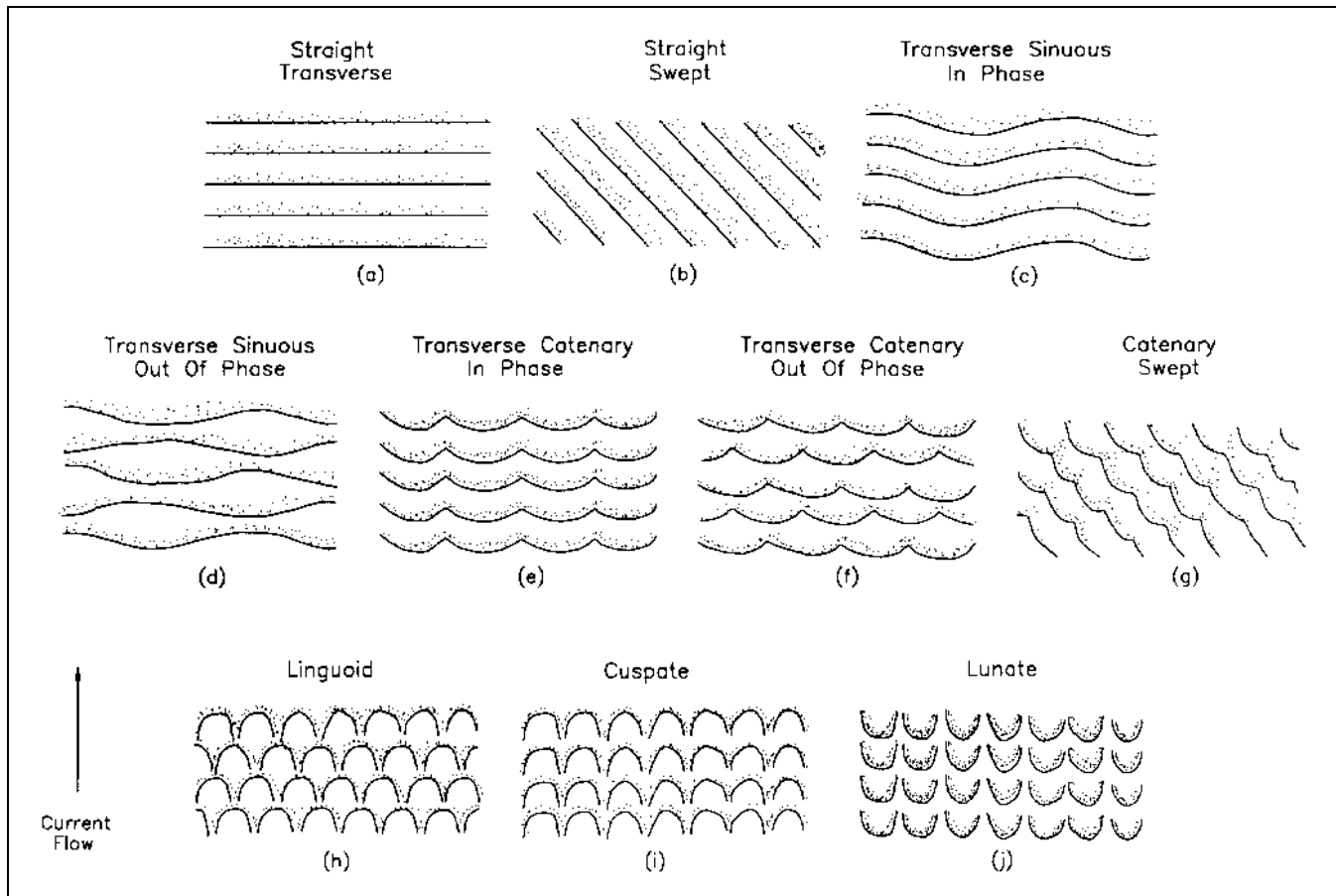

Figure 4-1. Sediment ripples. Water flow is from bottom to top, and lee sides and spurs are stippled (modified from Allen (1968))

“jump” in behavior occurs, resulting in the appearance of the larger dunes (Allen 1968).

e. Dunes. Dunes are flow-transverse bed forms with spacings from under 1 m to over 1,000 m that develop on a sediment bed under unidirectional currents. These large bed forms are ubiquitous in sandy environments where water depths are greater than about 1 m, sand size coarser than 0.15 mm (very fine sand), and current velocities greater than about 0.4 m/sec. In nature, these flow-transverse forms exist as a continuum of sizes without natural breaks or groupings (Ashley 1990). For this reason, “dune” replaces terms such as megaripple or sand wave, which were defined on the basis of arbitrary or perceived size distributions. For descriptive purposes, dunes can be subdivided as small (0.6 - 5 m wavelength), medium (5 - 10 m), large (10 - 100 m), and very large (> 100 m). In addition, the variation in pattern across the flow must be specified. If the flow pattern is relatively unchanged perpendicular to its overall direction and there are no

eddies or vortices, the resulting bed form will be straight crested and can be termed two-dimensional (Figure 4-2a). If the flow structure varies significantly across the predominant direction and vortices capable of scouring the bed are present, a three-dimensional bed form is produced (Figure 4-2b).

f. Plane beds. A plane bed is a horizontal bed without elevations or depressions larger than the maximum size of the exposed sediment. The resistance to flow is small, resulting from grain roughness, which is a function of grain size. Plane beds occur under two hydraulic conditions:

- The transition zone between the region of no movement and the initiation of dunes (Figure 4-2).
- The transition zone between ripples and antidunes, at mean flow velocities between about 1 and 2 m/sec (Figure 4-2).

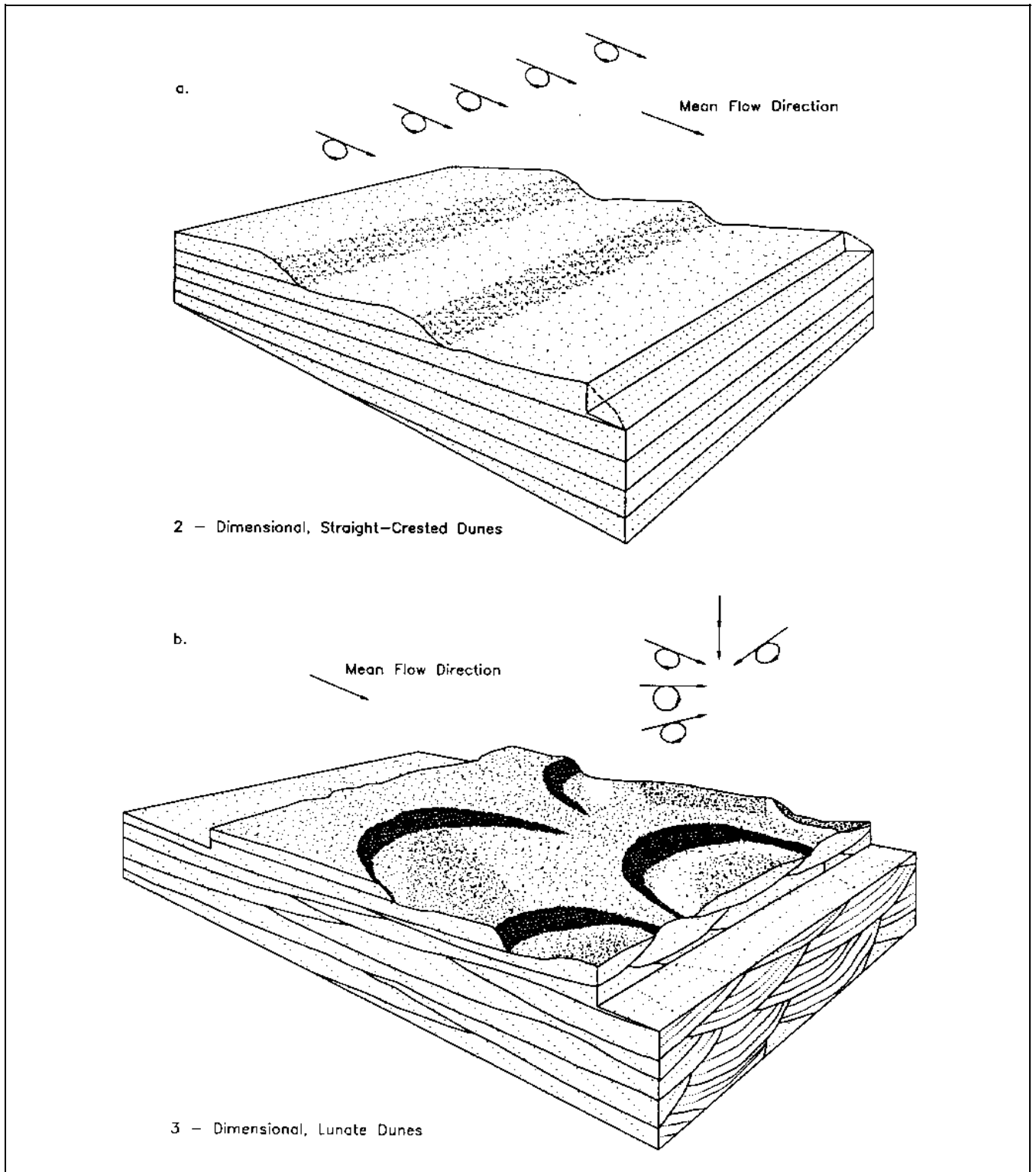

Figure 4-2. Two-dimensional and three-dimensional dunes. Vortices and flow patterns are shown by arrows above dunes. Adapted from Reineck and Singh (1980)

g. Antidunes. Antidunes are bed forms that are in phase with water surface gravity waves. Height and wavelength of these waves depend on the scale of the system and characteristics of the fluid and bed material (Reineck and Singh 1980). Trains of antidunes gradually build up from a plane bed as water velocity increases. As the antidunes increase in size, the water surface changes from planar to wave-like. The water waves may grow until they are unstable and break. As the sediment antidunes grow, they may migrate upstream or downstream, or may remain stationary (the name "antidune" is based on early observations of upstream migration).

h. Velocity - grain size relationships. Figure 4-3, from Ashley (1990) illustrates the zones where ripples, dunes, planar beds, and antidunes are found. The figure summarizes laboratory studies conducted by various researchers. These experiments appear to support the common belief that large flow-traverse bedforms (dunes) are a distinct entity separate from smaller current ripples. This plot is very similar to Figure 11.4 in Graf's (1984) hydraulics text, although Graf uses different axis units.

4-3. Deltaic Processes*

River deltas, which are found throughout the world, result from the interaction of fluvial and marine (or lacustrine) forces. According to Wright (1985), "deltas are defined more broadly as coastal accumulations, both subaqueous and subaerial, of river-derived sediments adjacent to, or in close proximity to, the source stream, including the deposits that have been secondarily molded by waves, currents, or tides." The processes that control delta development vary greatly in relative intensity around the world. As a result, delta-plain landforms span the spectrum of coastal features and include distributary channels, river-mouth bars, interdistributary bays, tidal flats, tidal ridges, beaches, beach ridges, dunes and dune fields, and swamps and marshes. Despite the pronounced variety of worldwide environments where deltas are found, all actively forming deltas have at least one common attribute: a river supplies clastic sediments to the coast and inner shelf more rapidly than marine processes can remove these materials. Whether a river is sufficiently large to transport enough sediment to overcome erosive marine processes depends upon the climate, geology, and nature of the drainage basin, and, most important, the overall size of the basin. The following paragraphs discuss delta classification, riverine flow, sediment deposition, and geomorphic structures associated with deltas.

a. General delta classification. Coleman and Wright (1975) identified six broad classes of deltas using an energy criteria. These models have been plotted on Figure 4-4 according to the relative importance of river, wave, and tide processes. However, Wright (1985) acknowledged that because each delta has unique and distinct features, no classification scheme can adequately encompass the wide variety of environments and structures found at deltas around the world.

b. Delta-forming processes.

(1) Force balance. Every delta is the result of a balance of forces that interact in the vicinity of the river mouth. A river carries sediment to the coast and deposits it beyond the mouth. Tidal currents and waves rework the newly deposited sediments, affecting the shape and form of the resulting structure. The long-term evolution of a delta plain becomes a function of the rate of riverine sediment input and the rate and pattern of sediment reworking, transport, and deposition by marine processes after the initial deposition. On a large scale, gross deltaic shape is also influenced by receiving basin geometry, regional tectonic stability, rates of subsidence caused by compaction of newly deposited sediment, and rate of sea level rise.

(2) River-dominant deltas.

(a) River-dominant deltas are found where rivers carry so much sediment to the coast that the deposition rate overwhelms the rate of reworking and removal due to local marine forces. In regions where wave energy is very low, even low-sediment-load rivers can form substantial deltas.

(b) When a river is completely dominant over marine forces, the delta shape develops as a pattern of prograding, branching distributary channels (resembling fingers branching from a hand). Interdistributary features include open bays and marshes. A generalized isopach map for this type of delta (Type I in Coleman and Wright's (1975) classification) is shown in Figure 4-5. A prime example is the Mississippi River, which not only transports an enormous amount of sediment, but also empties into the low wave-energy, low tide-range Gulf of Mexico. The Mississippi is discussed in detail later in this section.

(3) Wave-dominant deltas.

(a) At wave-dominant deltas, waves sort and redistribute sediments delivered to the coast by rivers and remold

* Material in this section adapted from Wright (1985).

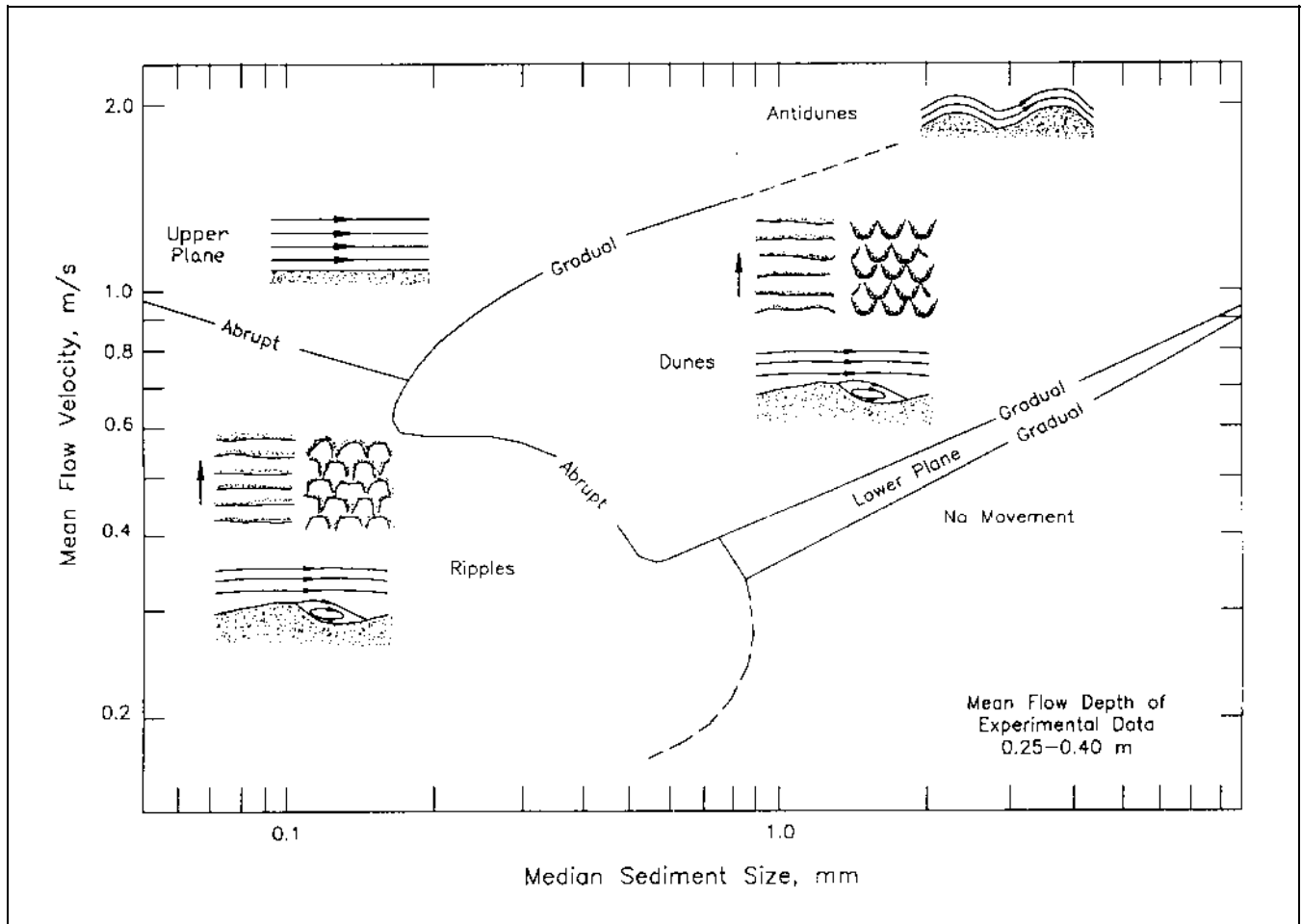

Figure 4-3. Plot of mean flow velocity against mean grain size, based on laboratory studies, showing stability phases of subaqueous bed forms (modified from Ashley (1990)). Original data from various sources, standardized to 10 °C water temperature (original data points not shown)

them into shoreline features such as beaches, barriers, and spits. The morphology of the resulting delta reflects the balance between sediment supply and the rate of wave reworking and redistribution. Wright and Coleman (1972; 1973) found that deltas in regions of the highest nearshore wave energy flux developed the straightest shoreline and best-developed interdistributary beaches and beach-ridge complexes.

(b) Of 16 deltas compared by Wright and Coleman (1972; 1973), the Mississippi was the most river-dominated while the Senegal in west Africa was the other extreme, the most wave-dominated. A model of the Senegal (Type VI in Figure 4-5) shows that abundant beach ridges are parallel to the prevailing shoreline trend and that the shore is relatively straight as a result of high wave energy and a strong unidirectional littoral drift.

(c) An intermediate delta form is represented by the delta of the Rio São Francisco del Norte in Brazil (Type V in Figure 4-5). Distributary-mouth-bar deposits are restricted to the immediate vicinity of the river mouth and are quickly remolded by waves. Persistent wave energy redistributes the riverine sediment to form extensive sand sheets. The exposed delta plain consists primarily of beach ridges and eolian dune fields.

(4) Tide-dominant deltas.

Three important processes characterize tide-dominated deltas:

(a) At the river mouths, mixing obliterates vertical density stratification, eliminating the effects of buoyancy.

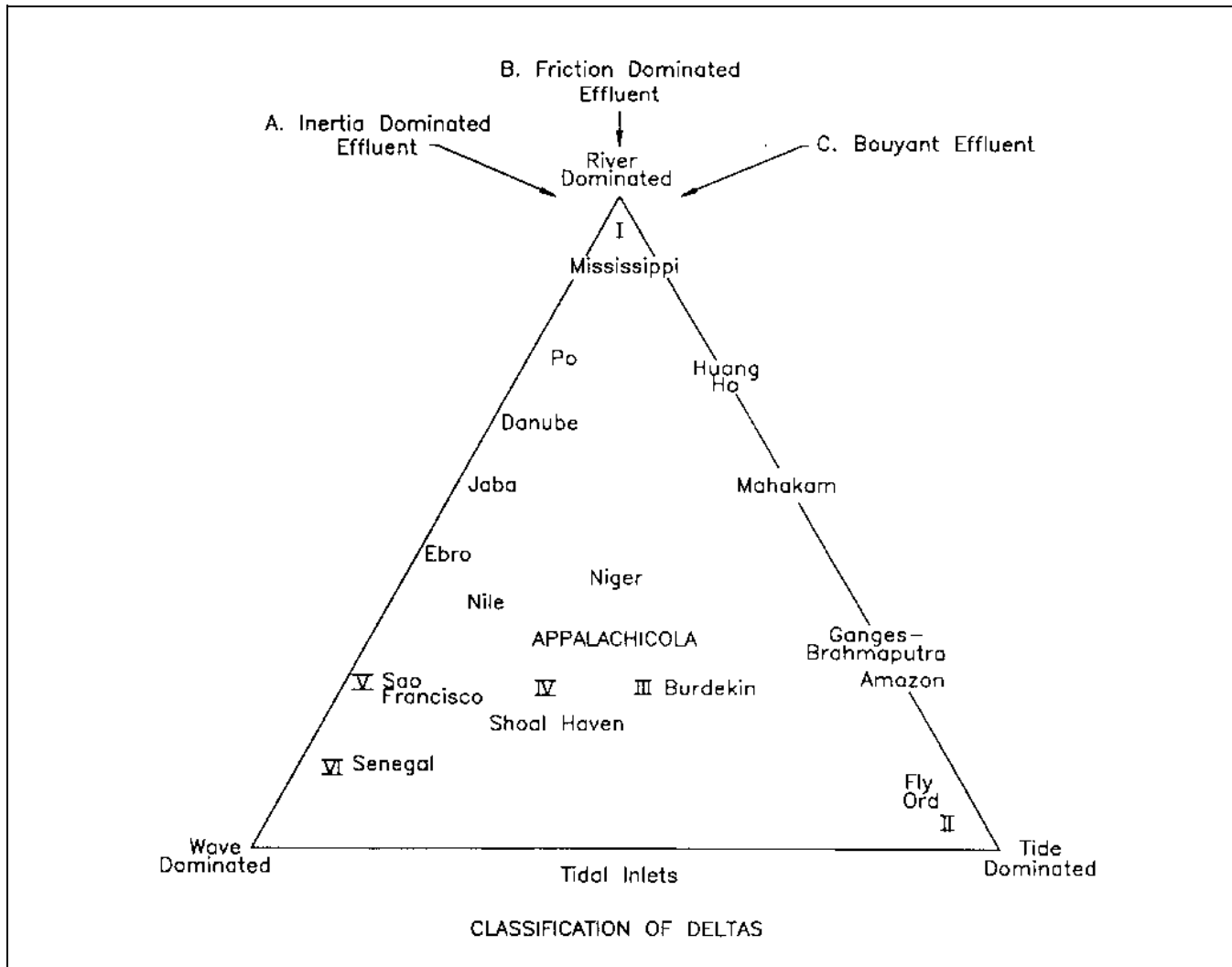

Figure 4-4. Comparison of deltaic dispositional models in terms of the relative importance of river, wave, and tide processes (from Wright (1985))

(b) For part of the year, tidal currents may be responsible for a greater fraction of the sediment-transporting energy than the river. As a result, sediment transport in and near the river mouth is bidirectional over a tidal cycle.

(c) The location of the land-sea interface and the zone of marine-riverine interactions is greatly extended both vertically and horizontally. Examples of deltas that are strongly influenced by tides include the Ord (Australia), Shatt-al-Arab (Iraq), Amazon (Brazil), Ganges-Brahmaputra (Bangladesh), and the Yangtze (China).

Characteristic features of river mouths in macrotidal environments are bell-shaped, sand-filled channels and linear tidal sand ridges. The crests of the ridges, which have

relief of 10-20 m, may be exposed at low tide. The ridges replace the distributary-mouth bars found at other deltas and become the dominant sediment-accumulation form. As the delta progrades over time, the ridges grow until they are permanently exposed, forming large, straight tidal channels (Type II in Figure 4-5). An example of a macrotidal delta is the Ord of Western Australia.

(5) Intermediate forms.

(a) As stated above, the morphology of most deltas is a result of a combination of riverine, tidal, and wave forces. One example of an intermediate form is the Burdekin Delta of Australia (Type II in Figure 4-5).

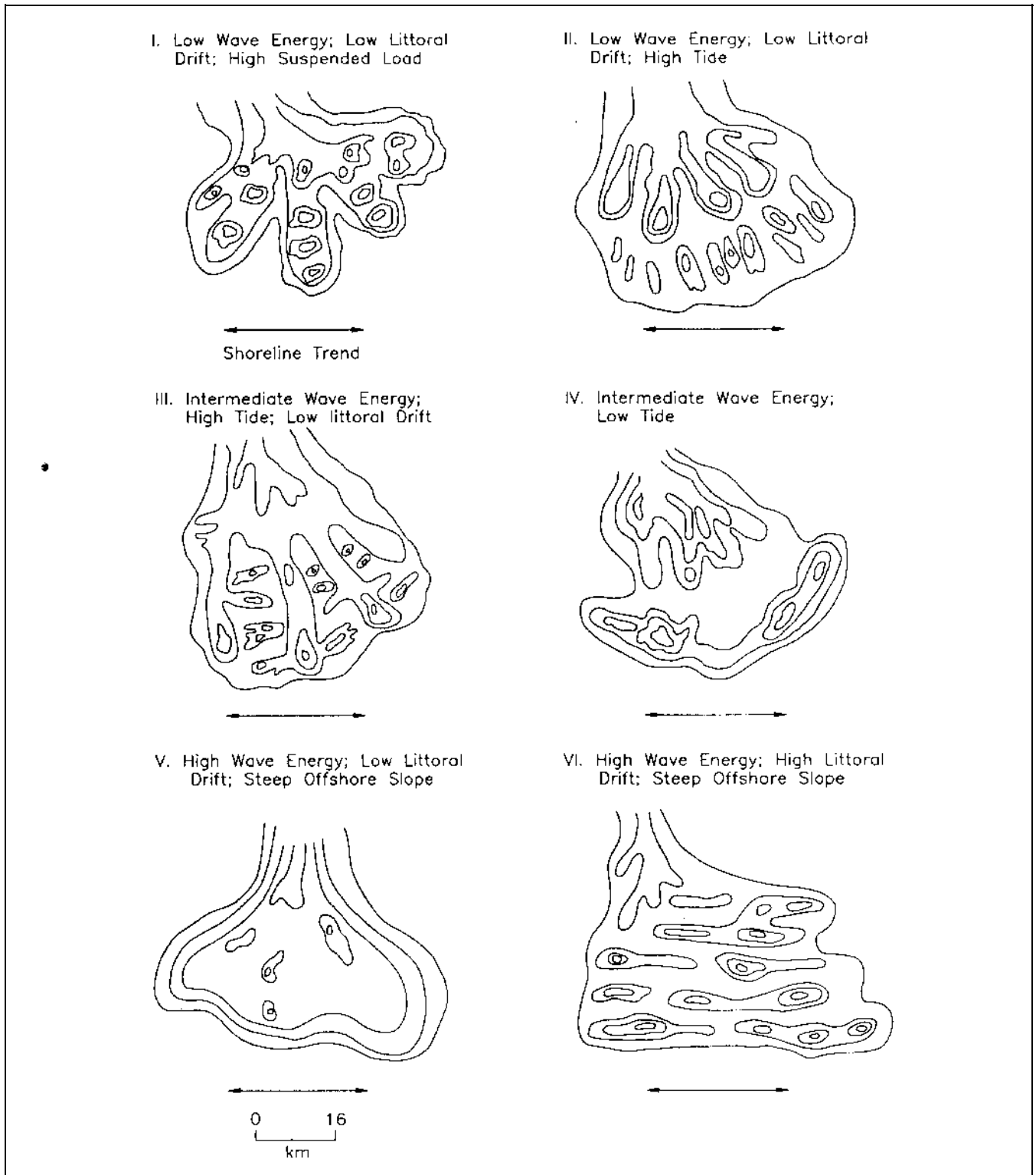

Figure 4-5. Isopach maps of six deltaic models (from Coleman and Wright (1973)). Locations of models with respect to energy factors are plotted in Figure 4-1

High waves redistribute sands parallel to the coastline trend and remold them into beach ridges and barriers. Within the river mouths, tidal currents produce sand-filled river channels and tidal creeks. This type of delta displays a broad range of characteristics, depending upon the relative strength of waves versus tides. In addition, features may vary seasonally if runoff and wave climate change. Other examples include the Irrawaddy (Burma), Mekong (Vietnam), and Red (Vietnam) Deltas (Wright 1985).

(b) The fourth model of delta geometry is characterized by offshore bay-mouth barriers that shelter lagoons, bays, or estuaries into which low-energy deltas prograde (Type IV, Figure 4-5). Examples include the Appalachicola (Florida Panhandle), Sagavanirktok (Alaska), and Shoalhaven (southeastern Australia) Deltas (Wright 1985). In contrast to the river-dominant models, the major accumulation of prodelta mud occurs landward of the main sand body (the barrier), and at the same elevation, within the protected bay. Although suspended fines reach the open sea, wave action prevents mud accumulation as a distinct unit over the open shelf.

c. *River mouth flow and sediment deposition.*

(1) River mouth geometry and river mouth bars are influenced by, and in turn influence, effluent dynamics. This subject needs to be examined in detail because the principles are pertinent to both river mouths and tidal inlets. Diffusion of the river's effluent and the subsequent sediment dispersion depend on the relative strengths of three main factors:

- Inertia of the issuing water and associated turbulent diffusion.
- Friction between the effluent and the seabed immediately seaward of the mouth.
- Buoyancy resulting from density contrasts between river flow and ambient sea or lake water.

Based on these forces, three sub-classes of deltaic deposition have been identified for river-dominated deltas (Figure 4-4). Two of these are well illustrated by depositional features found on the Mississippi delta.

(2) Depositional model type A - inertia-dominated effluent.

(a) When outflow velocities are high, depths immediately seaward of the mouth tend to be large,

density contrasts between the outflow and ambient water are low, and inertial forces dominate. As a result, the effluent spreads and diffuses as a turbulent jet (Figure 4-6a). As the jet expands, its momentum decreases, causing a reduction of its sediment carrying capacity. Sediments are deposited in a radial pattern, with the coarser bed load dropping just beyond the point where the effluent expansion is initiated. The result is basinward-dipping foreset beds.

(b) This ideal model is probably unstable under most natural conditions. As the river continues to discharge sediment into the receiving basin, shoaling eventually occurs in the region immediately beyond the mouth (Figure 4-6b). For this reason, under typical natural conditions, basin depths in the zone of the jet's diffusion are unlikely to be deeper than the outlet depth. Effluent expansion and diffusion become restricted horizontally as a plane jet. More important, friction becomes a major factor in causing rapid deceleration of the jet. Model 'A' eventually changes into friction-dominated Model 'B'.

(3) Depositional model type B - friction-dominated effluent.

(a) When homopycnal,¹ friction-dominated outflow issues over a shallow basin, a distinct pattern of bars and subaqueous levees is formed (Figure 4-7). Initially, the rapid expansion of the jet produces a broad, arcuate radial bar. As deposition continues, natural subaqueous levees form beneath the lateral boundaries of the expanding jet where the velocity decreases most rapidly. These levees constrict the jet from expanding further. As the central portion of the bar grows upward, channels form along the lines of greatest turbulence, which tend to follow the subaqueous levees. The result is the formation of a bifurcating channel that has a triangular middle-ground shoal separating the diverging channel arms. The flow tends to be concentrated into the divergent channels and to be tranquil over the middle ground under normal conditions.

(b) This type of bar pattern is most common where nonstratified outflow enters a shallow basin. Examples of this pattern (known as *crevasse splays* or *overbank splays*) are found at crevasses along the Mississippi River levees. These secondary channels run perpendicular to the main Mississippi channels and allow river water to debouch into the broad, shallow interdistributary bays. This

¹ River water and ambient water have the same density (for example, a stream entering a freshwater lake).

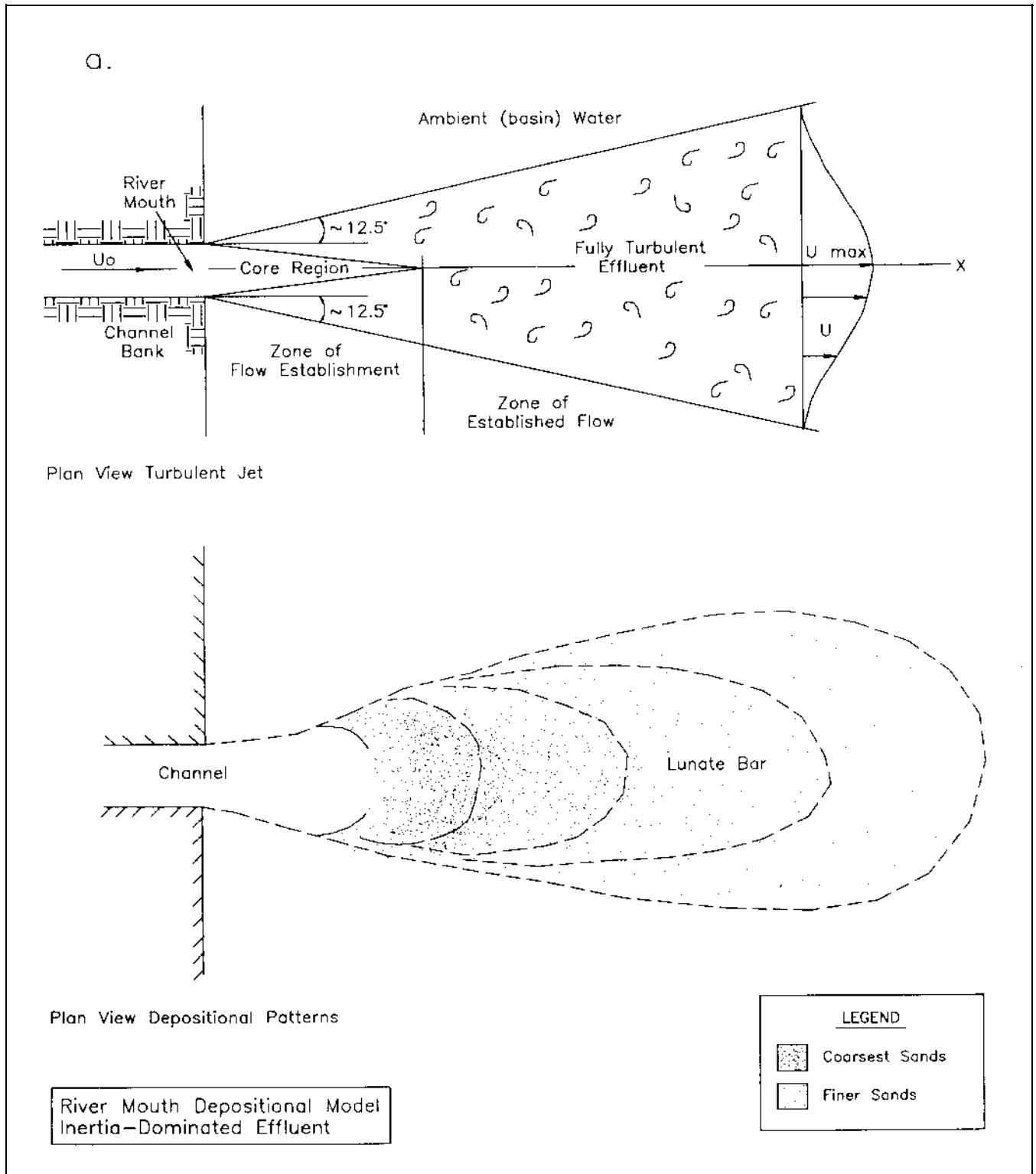

Figure 4-6. Plan view of depositional Model A, inertia-dominated effluent (adapted from Wright (1985)) (Continued)

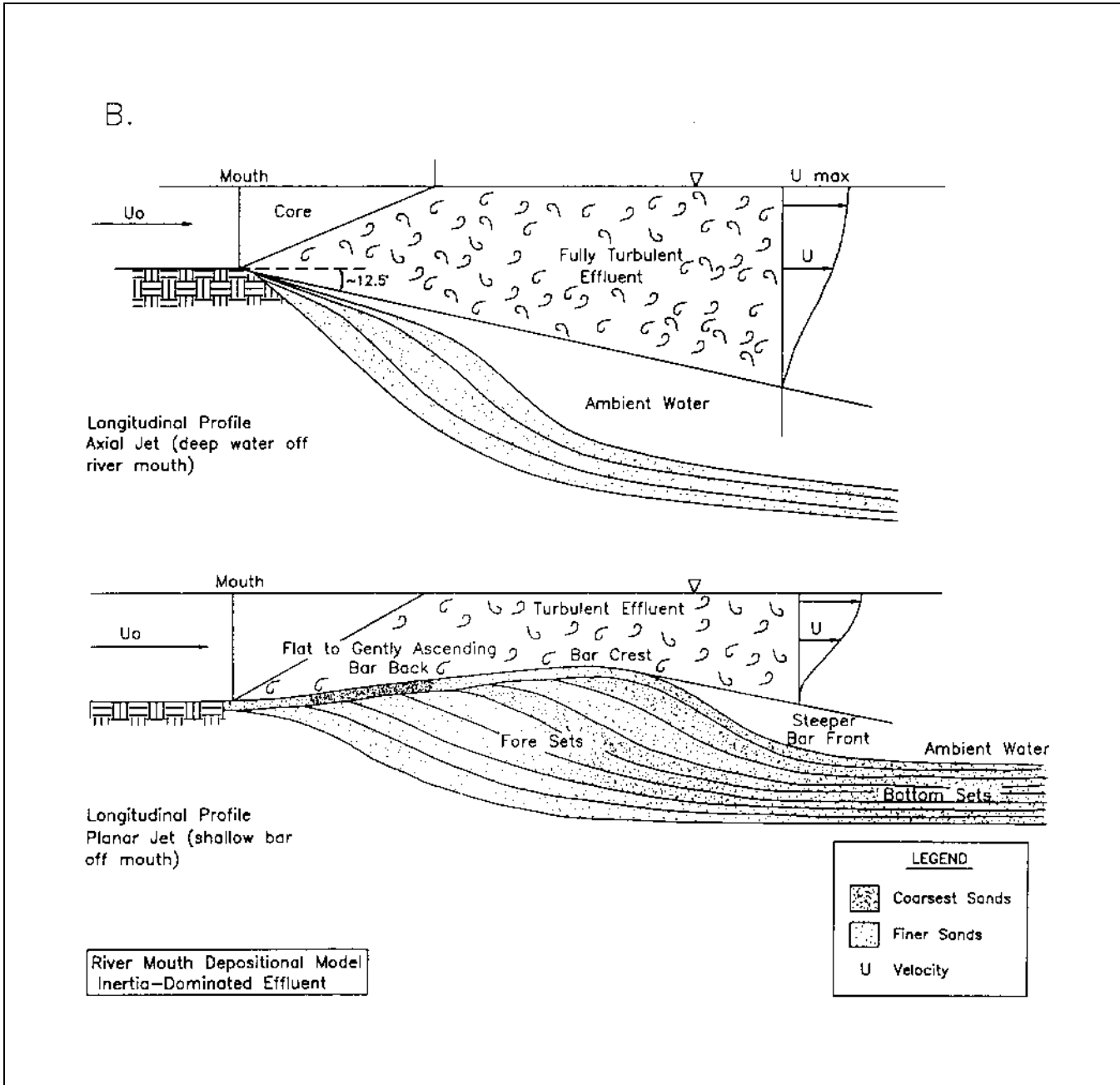

Figure 4-6. (Concluded)

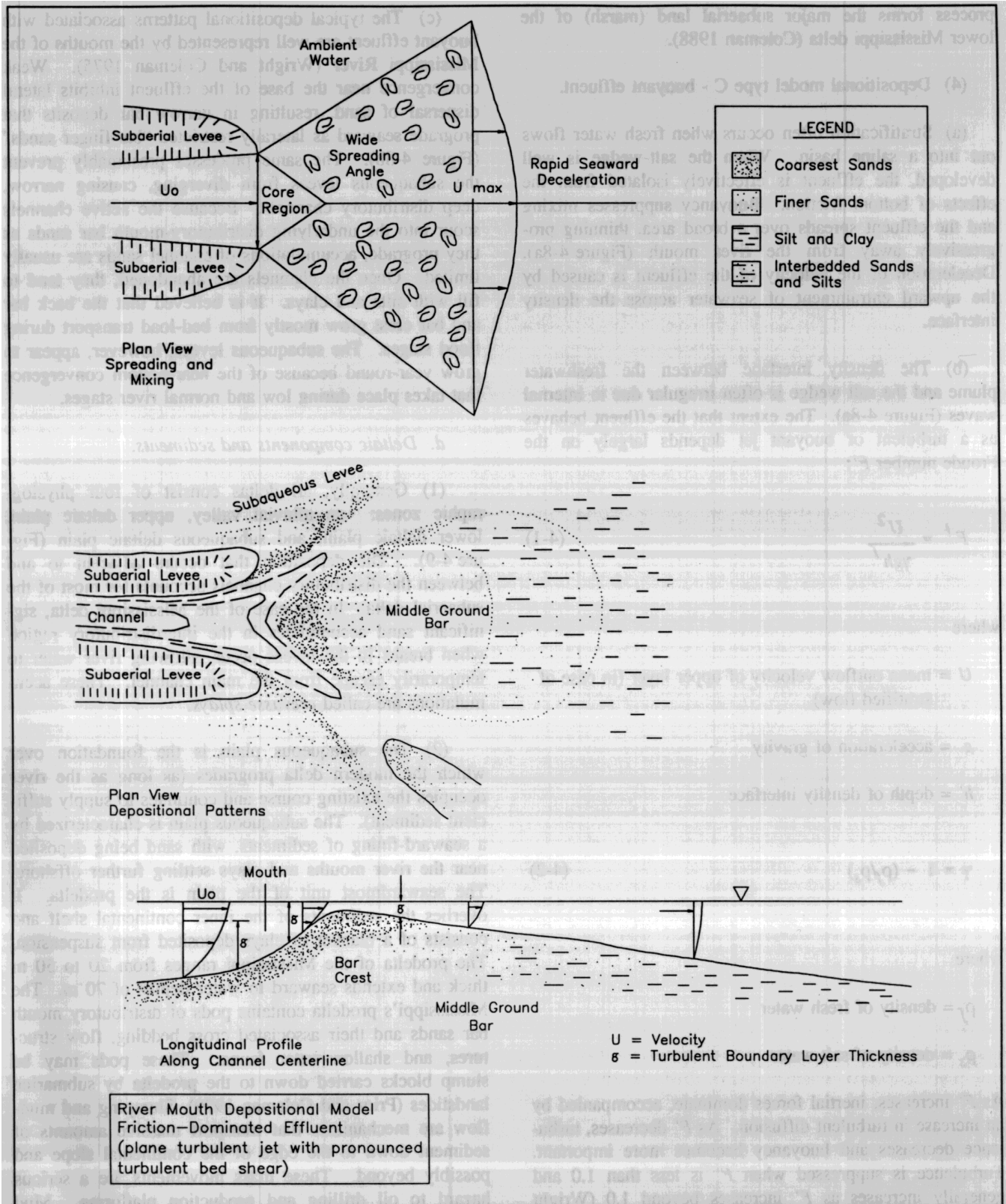

Figure 4-7. Depositional model type B, friction-dominated effluent (adapted from Wright (1985))

process forms the major subaerial land (marsh) of the lower Mississippi delta (Coleman 1988).

(4) Depositional model type C - buoyant effluent.

(a) Stratification often occurs when fresh water flows out into a saline basin. When the salt-wedge is well developed, the effluent is effectively isolated from the effects of bottom friction. Buoyancy suppresses mixing and the effluent spreads over a broad area, thinning progressively away from the river mouth (Figure 4-8a). Deceleration of the velocity of the effluent is caused by the upward entrainment of seawater across the density interface.

(b) The density interface between the freshwater plume and the salt wedge is often irregular due to internal waves (Figure 4-8a). The extent that the effluent behaves as a turbulent or buoyant jet depends largely on the Froude number F' :

$$F' = \frac{U^2}{\gamma g h'} \quad (4-1)$$

where

U = mean outflow velocity of upper layer (in case of stratified flow)

g = acceleration of gravity

h' = depth of density interface

$$\gamma = 1 - (\rho_f/\rho_s) \quad (4-2)$$

where

ρ_f = density of fresh water

ρ_s = density of salt water

As F' increases, inertial forces dominate, accompanied by an increase in turbulent diffusion. As F' decreases, turbulence decreases and buoyancy becomes more important. Turbulence is suppressed when F' is less than 1.0 and generally increases as F' increases beyond 1.0 (Wright 1985).

(c) The typical depositional patterns associated with buoyant effluent are well represented by the mouths of the Mississippi River (Wright and Coleman 1975). Weak convergence near the base of the effluent inhibits lateral dispersal of sand, resulting in narrow bar deposits that prograde seaward as laterally restricted "bar-finger sands" (Figure 4-8b). The same processes presumably prevent the subaqueous levees from diverging, causing narrow, deep distributory channels. Because the active channels scour into the underlying distributory-mouth bar sands as they prograde, accumulations of channel sands are usually limited. Once the channels are abandoned, they tend to fill with silts and clays. It is believed that the back bar and bar crest grow mostly from bed-load transport during flood stages. The subaqueous levees, however, appear to grow year-round because of the near-bottom convergence that takes place during low and normal river stages.

d. Deltaic components and sediments.

(1) Generally, all deltas consist of four physiographic zones: an alluvial valley, upper deltaic plain, lower deltaic plain, and subaqueous deltaic plain (Figure 4-9). The deposition that occurs adjacent to and between the distributory channels accounts for most of the subaerial delta. In the case of the Mississippi delta, significant sand accumulates in the interdistributory region when breaks in the levees occur, allowing river water to temporarily escape from the main channel. These accumulations are called *crevasse splays*.

(2) The subaqueous plain is the foundation over which the modern delta progrades (as long as the river occupies the existing course and continues to supply sufficient sediment). The subaqueous plain is characterized by a seaward-fining of sediments, with sand being deposited near the river mouths and clays settling further offshore. The seawardmost unit of the plain is the prodelta. It overlies the sediments of the inner continental shelf and consists of a blanket of clays deposited from suspension. The prodelta of the Mississippi ranges from 20 to 50 m thick and extends seaward to water depths of 70 m. The Mississippi's prodelta contains pods of distributory mouth bar sands and their associated cross bedding, flow structures, and shallow-water fauna. These pods may be slump blocks carried down to the prodelta by submarine landslides (Prior and Coleman 1979). Slumping and mud-flow are mechanisms that transport massive amounts of sediment down to the edge of the continental slope and possibly beyond. These mass movements are a serious hazard to oil drilling and production platforms. Mud diapirs, growth faults, mud/gas vents, pressure ridges, and

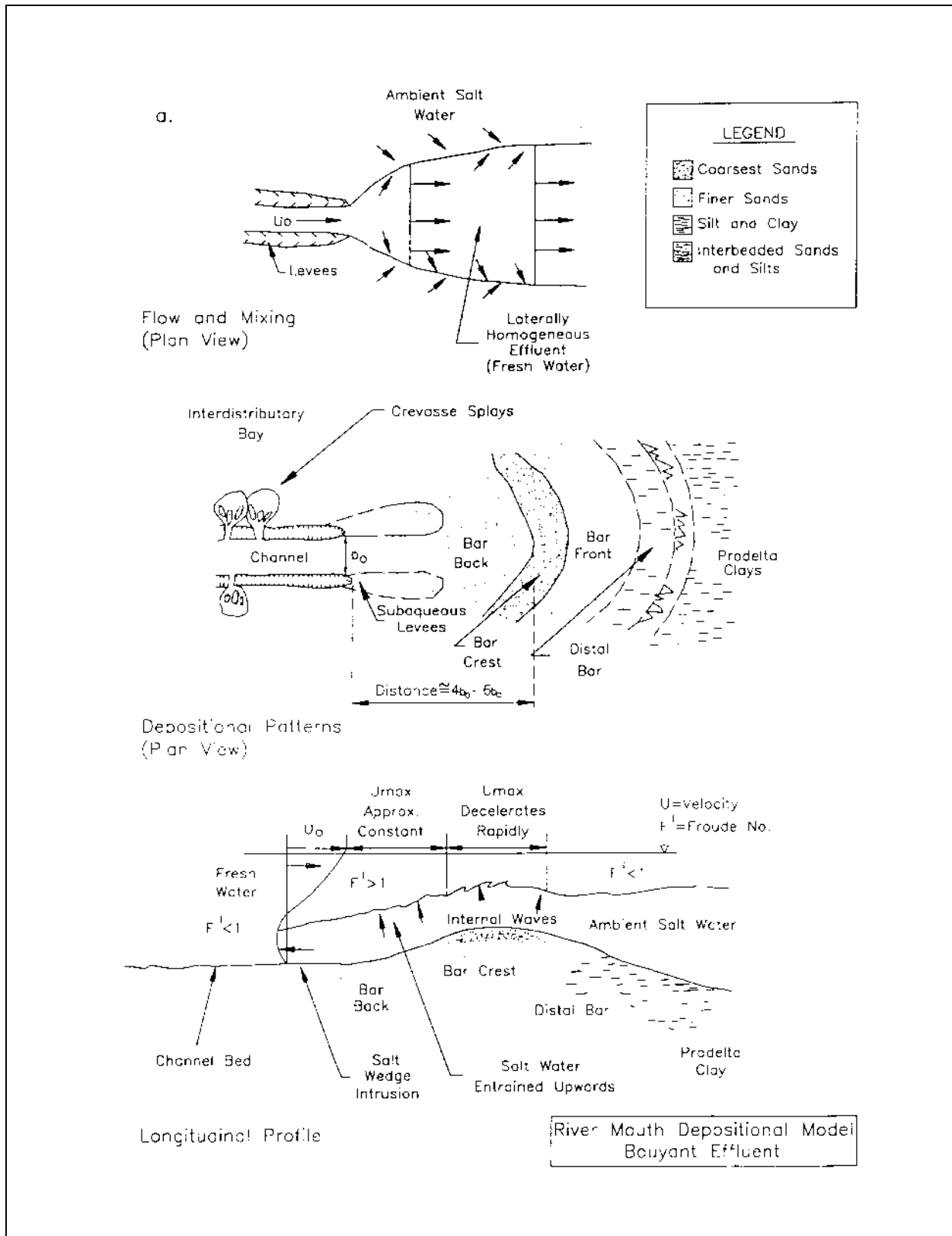

Figure 4-8. River mouth bar crest features, depositional model type C, buoyant effluent (adapted from Wright (1985)) (Continued)

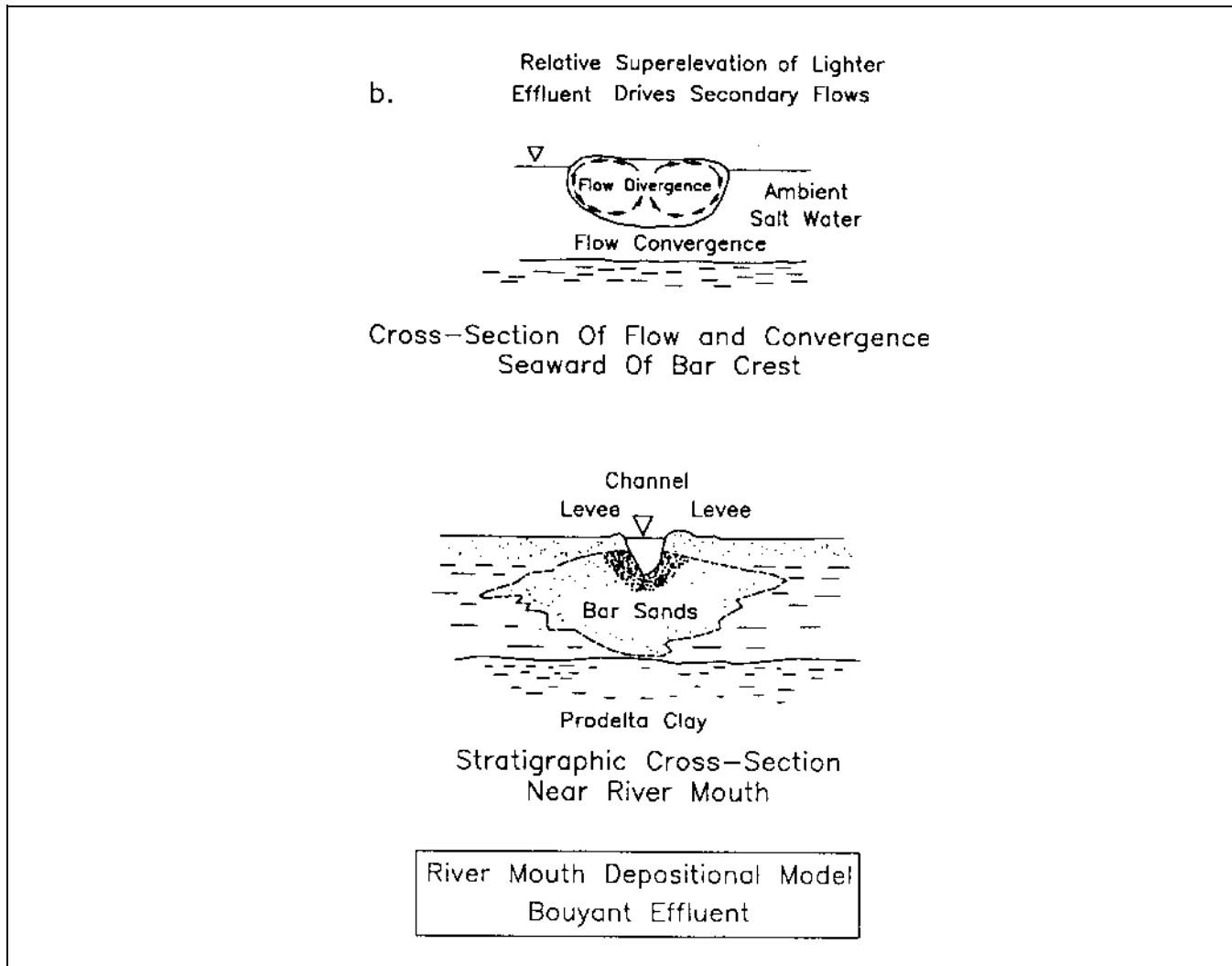

Figure 4-8. (Concluded)

mudflow gullies are other evidence of sediment instability on the Mississippi delta (Figure 4-10). Additional details of this interesting subject are covered in Coleman (1988), Coleman and Garrison (1977), Henkel (1970), and Prior and Coleman (1980).

(3) Above the delta front, there is a tremendous variability of sediment types. A combination of shallow marine processes, riverine influence, and brackish-water faunal activity causes the interdistributary bays to display an extreme range of lithologic and textural types. On deltas in high tide regions, the interdistributary bay deposits are replaced by tidal and intertidal flats. West of the Mississippi Delta is an extensive chenier plain. Cheniers are long sets of beach ridges, located on mudflats.

e. Mississippi Delta - Holocene history, dynamic changes.

(1) General. The Mississippi River, which drains a basin covering 41 percent of the continental United States (3,344,000 sq km), has built an enormous unconsolidated sediment accumulation in the Gulf of Mexico. The river has been active since at least late Jurassic times and has profoundly influenced deposition in the northern Gulf of Mexico. Many studies have been conducted on the Mississippi Delta, leading to much of our knowledge of deltaic sedimentation and structure. The ongoing research is a consequence of the river's critical importance to commerce and extensive petroleum exploration and

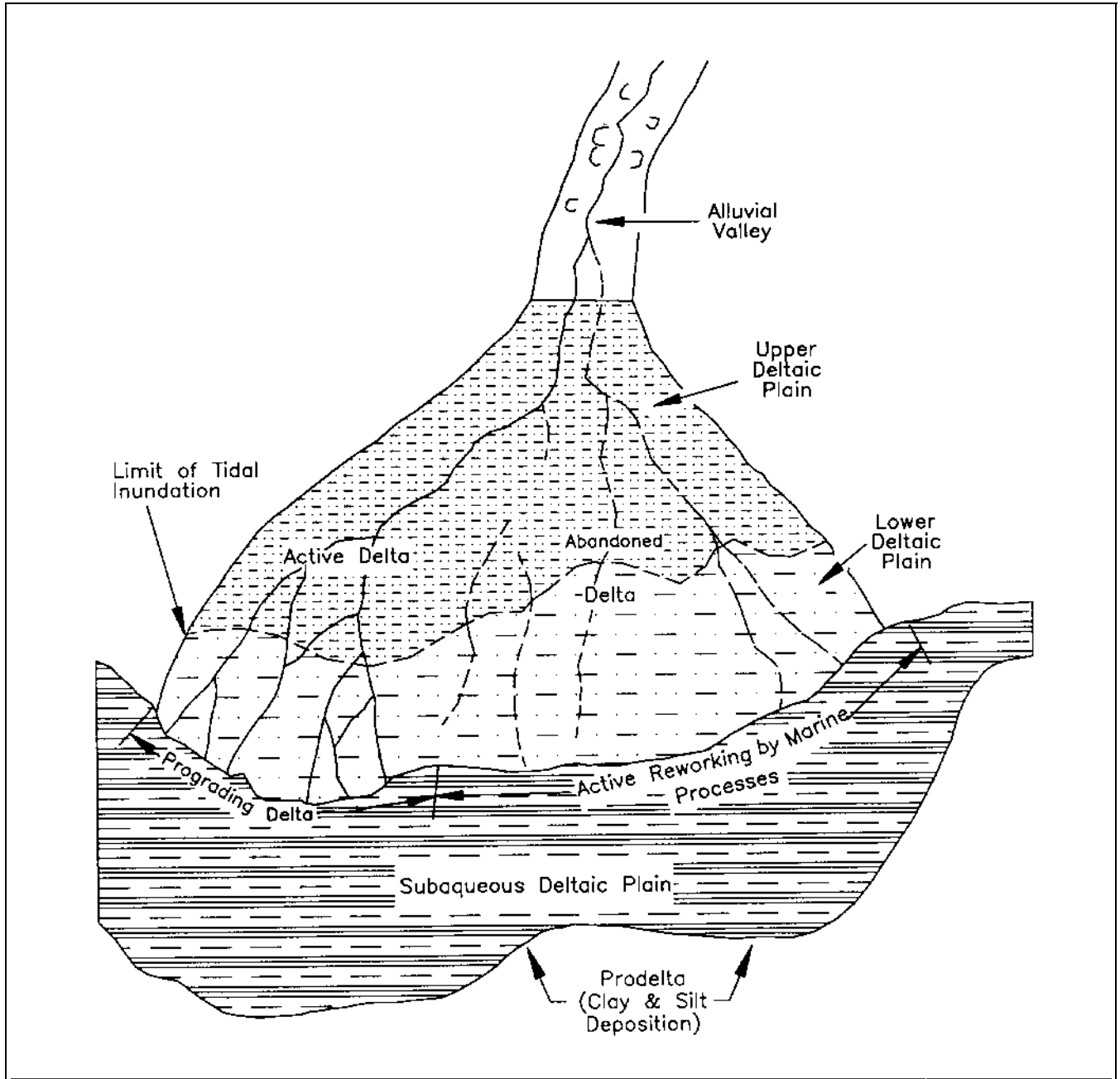

Figure 4-9. Basic physiographic units common to all deltas (from Wright (1985))

production in the northern Gulf of Mexico during the last 50 years.

(2) Deposition time scales. The Mississippi Delta consists of overlapping deltaic lobes. Each lobe covers 30,000 sq km and has an average thickness of about 35 m. The lobes represent the major sites of the river's deposition. The process of switching from an existing lobe to a new outlet takes about 1500 years

(Coleman 1988). Within a single lobe, deposition in the bays occurs from overbank flows, crevasse splays, and biological production. The bay fills, which cover areas of 250 sq km and have a thickness of only 15 m, accumulate in only about 150 years. Overbank splays, which cover areas of 2 sq km and are 3 m thick, occur during major floods when the natural levees are breached. The mouths of the Mississippi River have prograded seawards at remarkable rates. The distributory channels can form

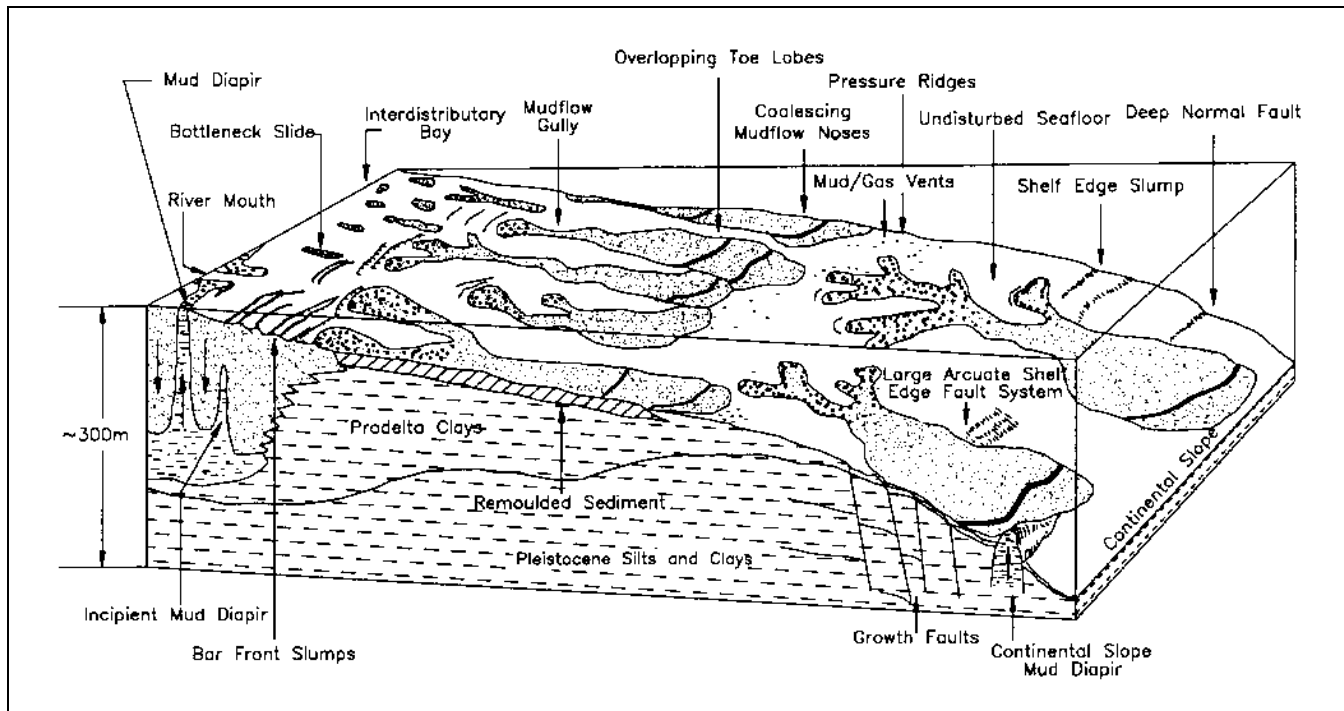

Figure 4-10. Structures and types of sediment instabilities on the Mississippi Delta (from Coleman (1988))

sand bodies that are 17 km long, 8 km wide, and over 80 m thick in only 200 years (Coleman 1988).

(3) Holocene history. During the last low sea level stand, 18,000 years ago, the Mississippi River entrenched its valley, numerous channels were scoured across the continental shelf, and deltas were formed near the shelf edge (Suter and Berryhill 1985). As sea level rose, the site of deposition moved upstream to the alluvial valley. By about 9,000 years before present, the river began to form its modern delta. In more recent times, the shifting deltas of the Mississippi have built a delta plain covering a total area of 28,500 sq km. The delta switching, which has occurred at high frequency, combined with a rapidly subsiding basin, has resulted in vertically stacked cyclic sequences. Because of rapid deposition and switching, in a short time the stacked cyclic deltaic sequences have attained thicknesses of thousands of meters and covered an area greater than 150,000 sq km (Coleman 1988). Figure 4-11 outlines six major lobes during the last 7,500 years.

(4) Modern delta. The modern delta, the Balize or Birdfoot, began to prograde about 800 to 1,000 years ago. Its rate of progradation has diminished recently and the river is presently seeking a new site of deposition. Within the last 100 years, a new distributary, the Atchafalaya,

has begun to divert an increasing amount of the river's flow. Without river control structures, the new channel would by now have captured all of the Mississippi River's flow, leading to rapid erosion of the Balize Delta. (It is likely that there would be a commensurate deterioration of the economy of New Orleans if it lost its river.) Even with river control projects, the Atchafalaya is actively building a delta in Atchafalaya Bay (lobe 6 in Figure 4-11).

f. Sea level rise and deltas.

(1) Deltas experience rapid local relative sea level rise because of the natural compaction of deltaic sediments from dewatering and consolidation. Deltas are extremely vulnerable to storms because the subaerial surfaces are flat and only slightly above the local mean sea level. Only a slight rise in sea level can extend the zone subject to storm surges and waves further inland. As stated earlier, delta evolution is a balance between the accumulation of fluviually supplied sediment and the reworking, erosion, and transport of deltaic sediment by marine processes (Wright 1985). Even a river like the Mississippi, which has a high sediment load and drains into a low wave-energy basin, is prograding only in the vicinity of the present distributary channels, the area defined as the active delta (Figure 4-9).

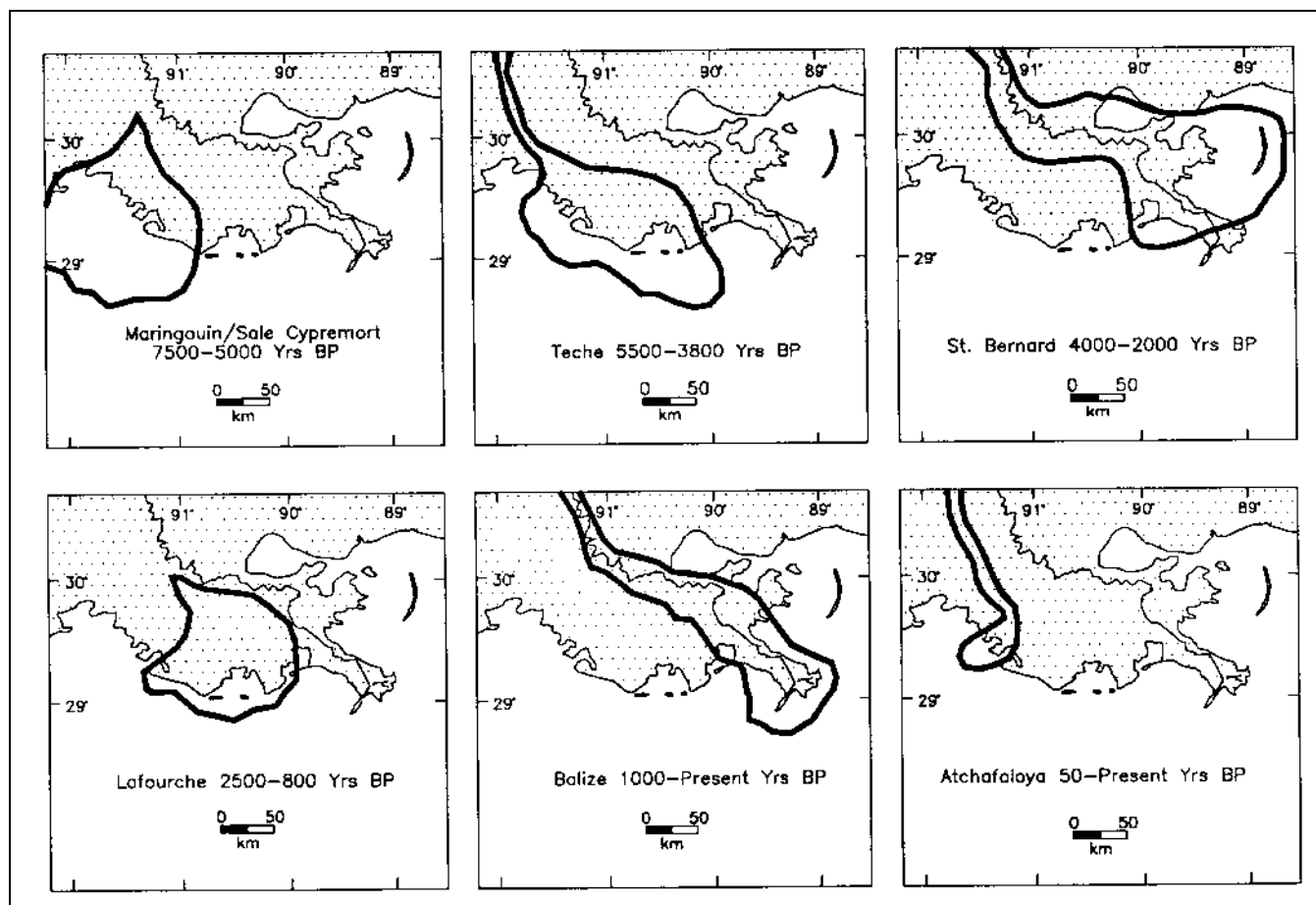

Figure 4-11. Shifting sites of deltaic sedimentation of the Mississippi River (from Coleman (1988))

(2) Deltas are highly fertile agriculturally because of the steady supply of nutrient-laden soil. As a result, some of the world's greatest population densities - over 200 inhabitants per sq km - are found on deltas (*The Times Atlas of the World* 1980):

- Nile Delta, Egypt.
- Chang Jiang (Yangtze), China.
- Mekong, Vietnam.
- Ganga (Ganges), Bangladesh.

These populations are very vulnerable to delta land loss caused by rising sea level and by changes in sediment supply due to natural movements of river channels or by upland man-made water control projects.

(3) Inhabitants of deltas are also in danger of short-term changes in sea level caused by storms. Tropical

storms can be devastating: the Bay of Bengal cyclone of November 12, 1970, drowned over 200,000 persons in what is now Bangladesh (Carter 1988). Hopefully, public education, improving communications, better roads, and early warning systems will be able to prevent another disaster of this magnitude. Coastal management in western Europe, the United States, and Japan is oriented towards the orderly evacuation of populations in low-lying areas and has greatly reduced storm-related deaths. In contrast to the Bay of Bengal disaster, Hurricane Camille (August 17-20, 1969), caused only 236 deaths in Louisiana, Mississippi, Alabama, and Florida.

4-4. Inlet Processes and Dynamics

a. Introduction.

(1) Coastal inlets play an important role in nearshore processes around the world. *Inlets* are the openings in coastal barriers through which water, sediments, nutrients, planktonic organisms, and pollutants are exchanged

between the open sea and the protected embayments behind the barriers. Inlets are not restricted to barrier environments or to shores with tides; on the West Coast and in the Great Lakes, many river mouths are considered to be inlets, and in the Gulf of Mexico, the wide openings between the barriers, locally known as passes, are also inlets. Inlets can be cut through unconsolidated shoals or emergent barriers as well as through clay, rock, or organic reefs (Price 1968). There is no simple, restrictive definition of inlet - based on the geologic literature and on regional terminology, almost any opening in the coast, ranging from a few meters to several kilometers wide, can be called an inlet. Inlets are important economically to many coastal nations because harbors are often located in the back bays, requiring that the inlets be maintained for commercial navigation. At many inlets, the greatest maintenance cost is that incurred by repetitive dredging of the navigation channel. Because inlets are hydrodynamically very complex, predictions of shoaling and sedimentation have often been unsatisfactory. A better understanding of inlet sedimentation patterns and their relationship to tidal and other hydraulic processes can hopefully contribute to better management and engineering design.

(2) Tidal inlets are analogous to river mouths in that sediment transport and deposition patterns in both cases reflect the interaction of outflow inertia and associated turbulence, bottom friction, buoyancy caused by density stratification, and the energy regime of the receiving body of water (Wright and Sonu 1975). However, two major differences usually distinguish lagoonal inlets from river mouths, sometimes known as fluvial or riverine inlets (Oertel 1982).

a. Lagoonal tidal inlets experience diurnal or semi-diurnal flow reversals.

b. Lagoonal inlets have two opposite-facing mouths, one seaward and the other lagoonward. The sedimentary structures which form at the two openings differ because of differing energy, water density, and geometric factors.

(3) This section reviews tidal flow in inlets and relates it to sedimentary structures found in the channels and near the mouths. Several conceptual models are reviewed and compared to processes that have been observed on the Atlantic and Gulf Coasts of the United States.

(4) The term *lagoon* refers to the coastal pond or embayment that is connected to the open sea by a tidal inlet. The *throat* of the inlet is the zone of smallest cross

section, which, accordingly, has the highest flow velocities. The *gorge* is the deepest part of an inlet and may extend seaward and landward of the throat (Oertel 1988). *Shoal* and *delta* are often used interchangeably to describe the ebb-tidal sand body located at the seaward mouth of an inlet.

b. Technical literature. Pioneering research on the stability of inlets was performed by Francis Escoffier (1940, 1977). O'Brien (1931, 1976) derived general empirical relationships between tidal inlet dimension and tidal prism. Keulegan (1967) developed algorithms to relate tidal prism to inlet cross section. Bruun (1966) examined inlets and littoral drift, and Bruun and Gerritsen (1959, 1961) studied bypassing and the stability of inlets. Hubbard, Oertel, and Nummedal (1979) described the influence of waves and tidal currents on tidal inlets in the Carolinas and Georgia. Hundreds of other works are referenced in the USACE *General Investigation of Tidal Inlets* (GITI) reports (Barwis 1976), in special volumes like *Hydrodynamics and Sediment Dynamics of Tidal Inlets* (Aubrey and Weishar 1988), in textbooks on coastal environments (Carter 1988; Cronin 1975; Komar 1976), and in review papers (Boothroyd 1985; FitzGerald 1988). Older papers on engineering aspects of inlets are cited in Castañer (1971). There are also numerous foreign works on tidal inlets: Carter (1988) cites references from the British Isles; Sha (1990) from the Netherlands; Nummedal and Penland (1981) and FitzGerald, Penland, and Nummedal (1984) from the North Sea coast of Germany; and Hume and Herdendorf (1988, 1992) from New Zealand.

c. Classification of inlets and geographic distribution.

(1) Tidal inlets, which are found around the world in a broad range of sizes and shapes, encompass a variety of geomorphic features. Because of their diversity, it has been difficult to develop a suitable classification scheme. One approach has been to use an energy-based criteria, in which inlets are ranked according to the wave energy and tidal range of the environment in which they are located.

(2) Regional geological setting can be a limiting factor restricting barrier and, in turn, inlet development. High relief, leading-edge coastlines have little room for sediment to accumulate either above or below sea level. Sediment tends to collect in pockets between headlands, few lagoons are formed, and inlets are usually restricted to river mouths. An example is the Pacific coast of North America, which, in addition to being steep, is subject to high wave energy.

(3) Underlying geology may also control inlet location and stability. Price and Parker (1979) reported that certain areas along the Texas coast were always characterized by inlets, although the passes tended to migrate back and forth along a limited stretch of the coast. The positions of these permanent inlets were tectonically controlled, but the openings were maintained by tidal harmonics and hydraulics. If storm inlets across barriers were not located at the established stable pass areas, the inlets usually closed quickly. Some inlets in New England are anchored by bedrock outcrops.

d. Hydrodynamic processes in inlets.

(1) General patterns of inlet flow. The interaction of a jet that issues from an inlet or river mouth with the downstream water mass is a complex phenomenon. Three broad classes of flow have been identified (Wright 1985):

- *Hypopycnal* outflow, in which a wedge of less dense fresh water flows over the denser sea water beyond the mouth.
- *Hyperpycnal* outflow, where the issuing water is denser than and plunges beneath the basin water.
- *Homopycnal* outflow, in which the jet and the downstream water are of the same density or are vertically mixed.

(a) Hypopycnal flow. Horizontally stratified hypopycnal flow is usually associated with river mouths and estuaries (Carter 1988; Wright 1985). As an example, the freshwater plume from the Amazon is so enormous when it spreads over the sea surface, early explorers of the New World refilled their water casks while still out of sight of land (Morrison 1974).

(b) Hyperpycnal flow. This occurs when outflow from hypersaline lagoons or rivers with extreme sediment load concentrations is denser than the water into which it issues. The Huang Ho River of China is cited as an example, but little has been published in English about this uncommon situation (Wright 1985). It is unknown if hyperpycnal conditions occur at any tidal inlets around the United States.

(c) Homopycnal flow. At most tidal inlets, strong jets - steady unidirectional currents - are produced as the tide rises and falls along the open coast and the water level in the lagoon rises and falls accordingly. Joshi and Taylor (1983) describe three elements of a fully developed jet:

(1) The source area upstream where the water converges before entering the pass (inlet).

(2) The strong, confined flow within the throat (jet).

(3) A radially expanding, vortex-dominated lobe downstream of the opening of the inlet (Figure 4-12).

(d) Carter (1988) reports that most inlet jets are homopycnal, especially at narrow inlets that drain large lagoons having no other openings to the sea. Presumably, his statement refers to tidal lagoons that have only a limited freshwater inflow. Where there is a significant fluvial input, the water in the lagoon becomes brackish and a more complicated flow regime develops. As an example, at East Pass, Florida, on the northeast Gulf of Mexico, the flow within the inlet proper is dominated by either the ebb or flood tide, but stratification occurs in Choctawhatchee Bay at the flood-tide shoal and at the Gulf of Mexico exit over the ebb-tide shoal.

(2) Jets and converging source flow at inlet openings. At inlets with stable margins (especially ones with jetties), the stream of turbulent water that discharges through the orifice into a large unrestricted basin can be considered a free jet (Oertel 1988). Either axial or planar jets can form, depending on the density difference between the outflow and the water into which it is flowing.

(a) Axial jets. Homopycnal flow through an orifice forms an axial jet. In an ideal system without friction or waves, the near field (the zone of flow establishment) extends about $4D$ seaward of the inlet's mouth, where D equals the diameter of the orifice (Figure 4-13a). Beyond $4D$, in the far field, the jet spreads and loses velocity. The current velocity in the near field is estimated to remain about the same as in the throat. Based on this model, Oertel (1988) suggests that well-established channels should form to a distance of about $4D$ from the inlet throat. In the far field, Unluata and Ozsoy (1977) calculated that there is an exponential growth in jet width and an exponential decay of center line velocity. Fort Pierce Inlet, on the Atlantic coast of Florida, is an example of a site where a distinct axial jet forms at ebb tide (Joshi and Taylor 1983).

(b) Planar jets. When the water emerging from an inlet is buoyant, a planar jet forms. This jet spreads more rapidly in the near field than the axial type, extending to a distance of about $4D$, where D = width of the mouth (Oertel 1988).

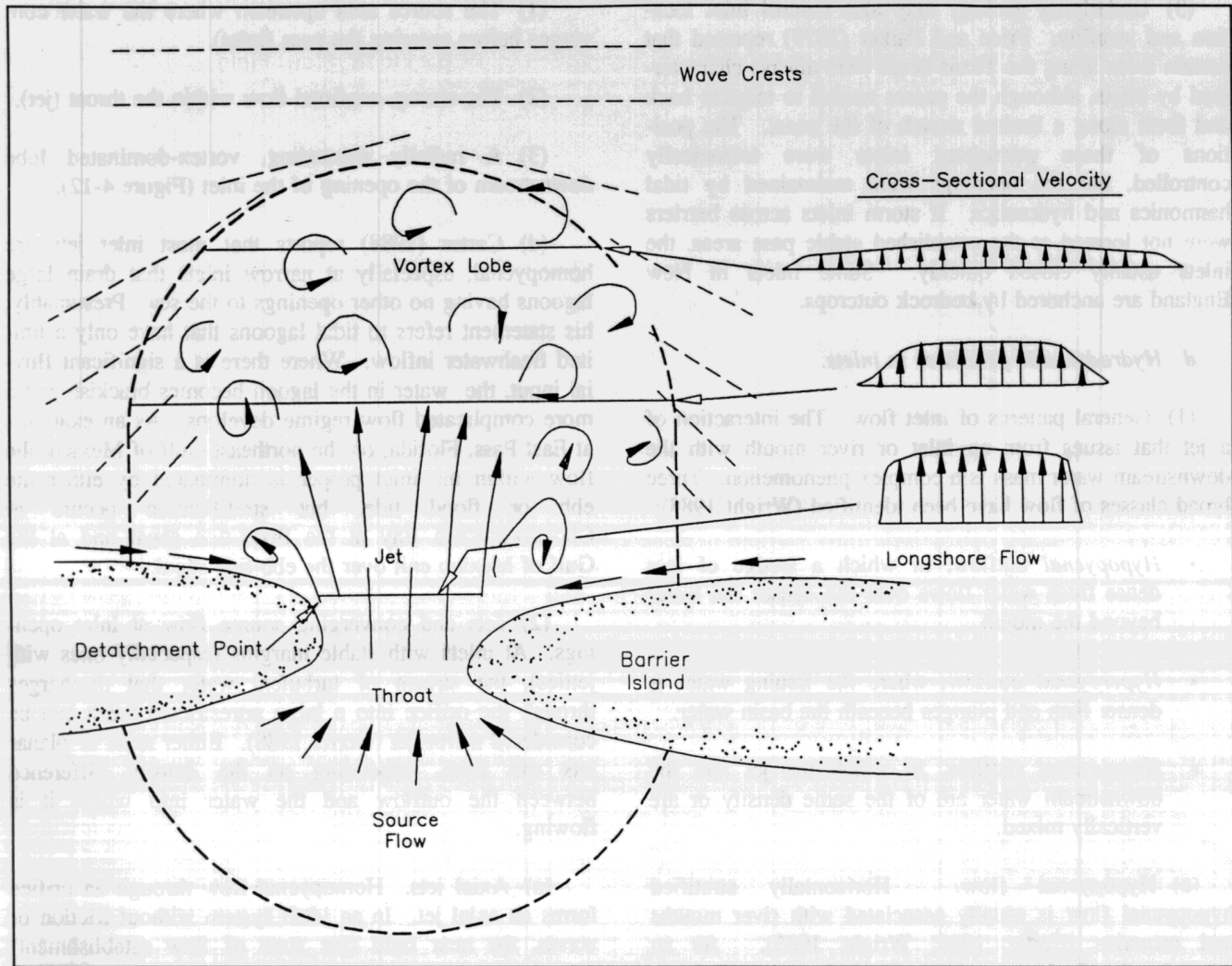

Figure 4-12. Three elements of flow through an idealized tidal inlet: source, jet, and expanding lobe (from Carter (1988))

(c) Planar jets at natural settings. In nature, the near and far fields of natural jets are affected by waves, littoral currents, friction, and bottom topography. Ismail and Wiegel (1983) have calculated that wave momentum flux is a major factor causing a jet's spreading rate to increase. The seafloor, especially if there is a shallow ebb-tide shoal, will squeeze the jet vertically and enhance spreading. Because of these factors, the planar jet model may be a more realistic description of the effluent at most tidal inlets. Aerial photographs from St. Mary's Entrance and Big Hickory and New Passes, Florida, clearly show jets spreading laterally immediately upon exiting the mouths (Joshi and Taylor 1983). At East Pass, Florida, dark, humate-stained water of the ebb tide expands beyond the jetties, forming an oval which covers the ebb-tide shoal. Drogue studies in 1970 showed that the

plume was buoyant and that below it, Gulf of Mexico water flowed in a westward direction (Sonu and Wright 1975).

(d) Flow at landward openings of inlets. Most of the technical literature has described jets that form at the seaward mouths of rivers or tidal inlets. On the landward side of inlets, a jet can only form if there is an open-water lagoon. In the back-bay areas of many barrier island systems, there are marshes and shoals, and flood flow is restricted to the deep channels (well-documented examples include North Inlet, South Carolina (Nummedal and Humphries 1978) and Sebastian Inlet, Florida (Stauble et al. 1988)). Both confined and jet-like flow may occur in lagoons in high tide-range coastlines. The

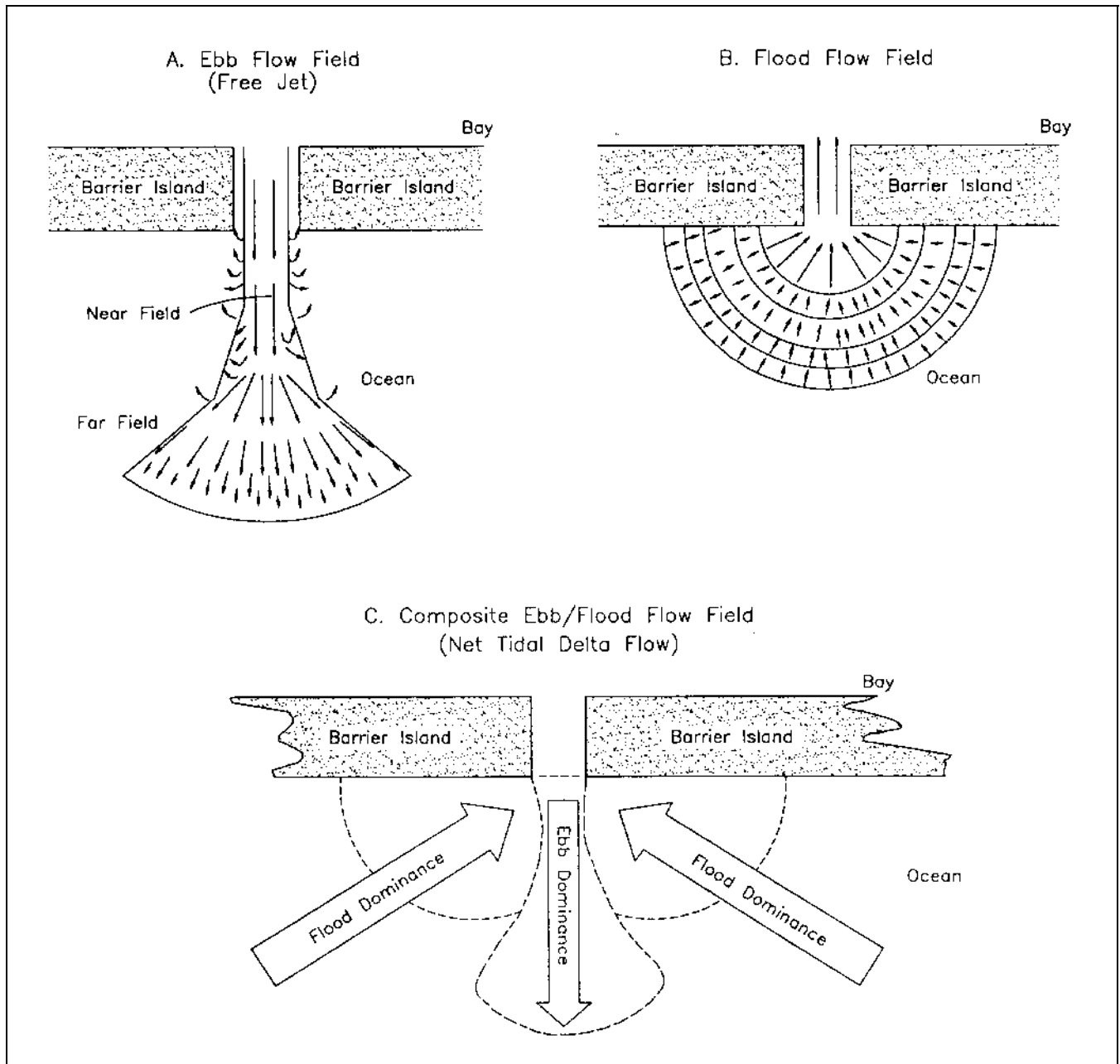

Figure 4-13. Sketch maps showing idealized flood and ebb flow fields (from Oertel (1988))

flood is initially restricted to established channels, but, as the water in the lagoon rises, the flow is able to spread beyond the confines of the channels and a plume develops. Nummedal and Penland (1981) documented this phenomenon in Norderneyer Seegat in Germany, where the tide range was 2.5 m.

(e) Source flow fields. During the flood at the seaward end of an unjettied inlet, the inflowing water

uniformly converges in a semicircular pattern towards the inlet's throat (Figure 4-13b; Oertel 1988). Because the flow field is so broadly distributed, flood velocity is much lower than ebb jet velocity, particularly in the near field. It is unclear how the source flow field behaves at an inlet with seaward-projecting jetties. It seems likely that the streamlines wrap around the projecting jetties, but velocities along the outer side of the jetties are probably low. It may be difficult to verify this model at most sites because

of the influence of waves, winds, currents, and local bathymetry.

(3) Influence of water mass stratification on inlet flow. When a lagoon contains brackish water, salt wedge dynamics can occur, where the incoming flood flows under less dense bay water. Mixing between the two waters occurs along a horizontal density interface. During ebb tide, a buoyant planar jet forms at the seaward opening of the inlet similar to the effluent from rivers.

(a) Wright, Sonu, and Kielhorn (1972) described how density stratification affected flow at the Gulf of Mexico and Choctawhatchee Bay openings of East Pass, Florida.

(b) During flood tide, drogues and dye showed that the incoming salty Gulf of Mexico water met the brackish bay water at a sharp density front and then dove underneath (Figure 4-14). The drogues indicated that the sea water intruded at least 100 m beyond the front into Choctawhatchee Bay. This was the reason that bed forms within the channels displayed a flood orientation over time.

(c) With the onset of ebb tide in East Pass, the seaward flow in the upper brackish layer increased in velocity and pushed the density front back towards the inlet. Initially, as the upper brackish layer flowed seaward, saline Gulf water underneath the interface continued to flow northwards into the bay. Within 2 hr after the onset of ebb flow, the current had reversed across the entire water column. As the brackish Choctawhatchee Bay water progressed southward through the inlet, it mixed to an increasing degree with the seawater underneath. By the time it reached the seaward mouth of the inlet, vertical mixing was nearly complete. As the ebb progressed, the wedge of brackish water continued to migrate seaward until it stopped near the edge of the flood-tide shoal bar crest, where it remained for the rest of the ebb cycle (Wright and Sonu 1975).

(4) Tidal flow and velocity asymmetry. *Tidal prism*, the amount of water that flows through an inlet, is determined by the tidal range, multiplied by the area of the bay which is supplied by the inlet. Prism may be one of the most important of the additional factors that determines the morphology of coastal inlets and their adjacent barrier islands (Davis and Hayes 1984). Along a reach of where tidal range is relatively constant, an inlet supplying a large bay will experience a much greater discharge than an inlet supplying a small bay. In addition, the inlet connecting the large bay to the sea will experience proportionately

greater discharge during times when tide range is high (e.g. spring tides). However, it takes considerable time for a large bay to fill and empty as the tidal cycle progresses; therefore, the overall range of water levels in a large bay may be less than in a small bay.

(a) Effect of back bay salt marshes. Nummedal and Humphries (1978) describe how the bathymetry of a bay controls the degree of velocity asymmetry through an inlet gorge. The bays in the southeastern United States are typically filled with intertidal salt marshes, leaving only about 20 percent of the bay area as open water. The large variation in water surface area during the tide cycle tends to produce a strong ebb-dominant flow in these systems.

(b) Beginning of flood tide. As the open-water tide begins to rise at the beginning of the flood, water flows into the inlet and rapidly floods the limited-volume tidal channels in the back bay. The flow at this stage is reasonably efficient because the water level in the channels is able to rise almost as quickly as water outside the inlet (some delay is caused by friction).

(c) Near high tide. Once the water level in the bay rises enough to inundate the tidal channels, any additional water is free to spread laterally over a much greater expanse of marsh terrain. As a result, a lag develops because the flood tide cannot flow through the inlet quickly enough to fill the bay and keep pace with the rise in the open-water tide.

(d) Beginning of ebb tide. At high tide, the bay water level is below the open-coast level. As a result, although the open coast tide is beginning to drop, the bay is still rising. Eventually, the two water levels equalize, and the flow through the inlet turns to ebb.

(e) Near low tide. At the final stages of the ebb tide, the water in the bay has fallen below the marsh level and water is primarily confined to the back bay tidal channels. Because the channels contain only a limited volume, the water level drops almost as quickly as the open-coast level. (However, the process is not totally efficient because considerable water continues to drain out of the plants and saturated soil over time.)

(f) Low tide. At low tide, water levels within the bay and along the open coast are almost equal. Therefore, as soon as the tide begins to rise, the flow in the inlet turns to flood.

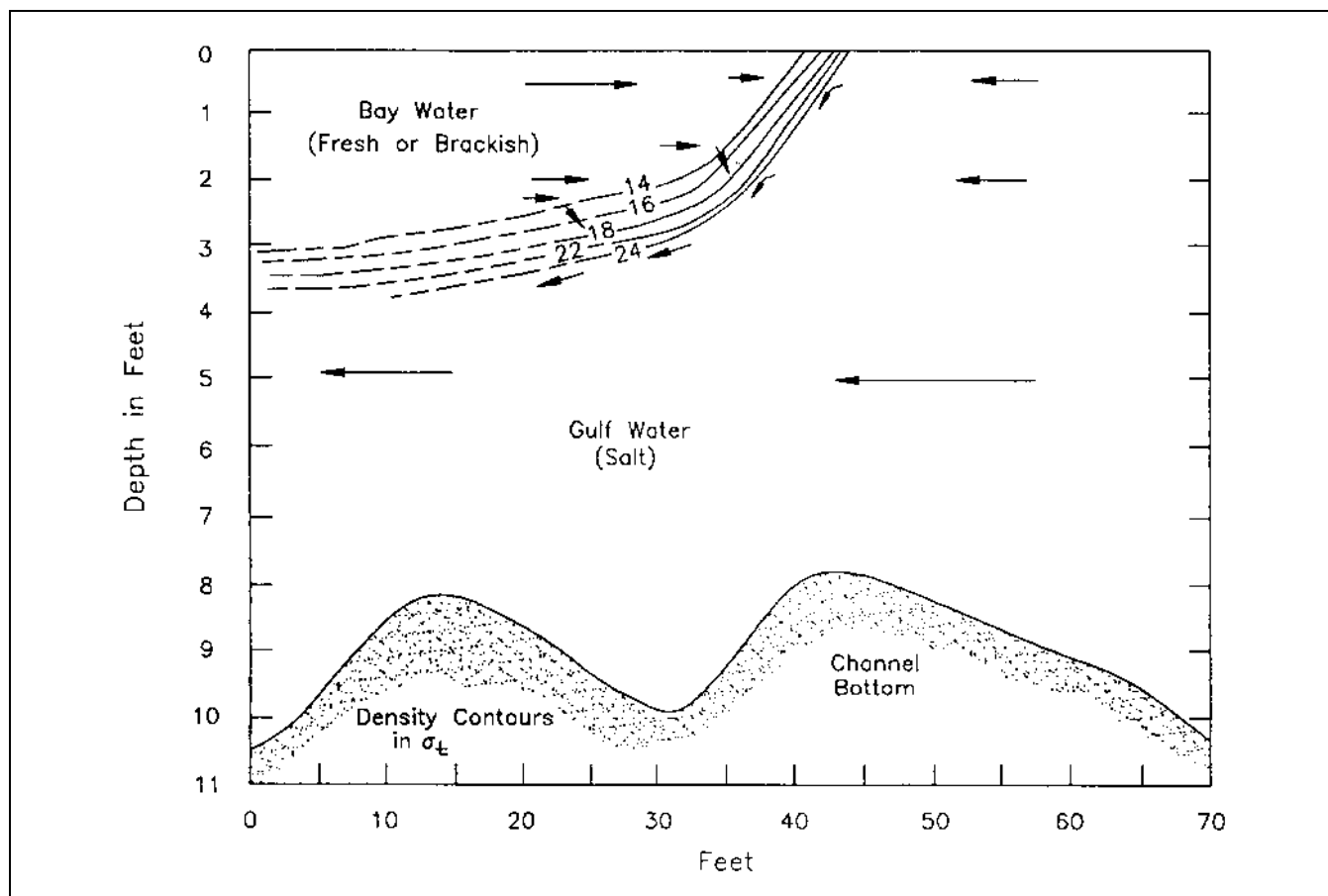

Figure 4-14. Stratified flow occurs during flood tide in Choctawhatchee Bay, Florida, as a wedge of sea water dives underneath the lower density bay water (after Wright, Sonu, and Kielhorn 1972). A similar phenomenon often occurs in estuaries

(g) Velocity asymmetry. The process described above results in a flood that is longer in duration than the ebb. As a result, average ebb velocity must be greater than flood. In addition, because of freshwater input, the total ebb volume may be greater than the flood, contributing to even higher velocities. Volumetric and velocity ebb dominance have been recorded at St. Marys Inlet and East Pass, Florida (Morang 1992).

(h) Net sediment movement. At Price Inlet, South Carolina (FitzGerald and Nummedal 1983) and North Inlet, South Carolina (Nummedal and Humphries 1978), because of peak ebb currents, the resulting seaward-directed sediment transport far exceeded the sediment moved landward during flood. However, ebb velocity dominance does not necessarily mean that net sediment movement is also seaward. At Sebastian Inlet, on Florida's east coast, Stauble et al. (1988) found that net sediment movement was landward although the tidal hydraulics displayed higher ebb currents. The authors

concluded that sediment carried into the inlet with the flood tide was deposited on the large, and growing, flood shoal. During ebb tide, current velocities over the flood shoal were too low to remobilize as much sediment as had been deposited on the shoal by the flood tide. The threshold for sediment transport was not reached until the flow was in the relatively narrow throat. In this case, the shoal had become a sink for sediment carried into the inlet. Stauble et al. hypothesized that this pattern of net landward sediment movement, despite ebb hydraulic dominance, may occur at other inlets in microtidal shores that open into large lagoons.

d. Geomorphology of tidal inlets. Tidal inlets are characterized by large sand bodies that are deposited and shaped by tidal currents and waves. The *ebb-tide shoal* (or delta) is a sand mass that accumulates seaward of the mouth of the inlet. It is formed by ebb tidal currents and is modified by wave action. The *flood-tide shoal* is an accumulation of sand at the landward opening of an inlet

that is mainly shaped by flood currents (Figure 4-15). Depending on the size and depth of the bay, an ebb shoal may extend into open water or may merge into a complex of meandering tributary channels, point bars, and muddy estuarine sediments.

(1) Ebb-tidal deltas (shoals).

(a) A simplified morphological model of a natural (unjettied) ebb-tidal delta is shown in Figure 4-15. The delta is formed from a combination of sand eroded from the gorge of the inlet and sand supplied by longshore currents. This model includes several components:

- A main *ebb channel*, scoured by the ebb jets.
- *Linear bars* that flank the main channel, the result of wave and tidal current interaction.
- A *terminal lobe*, located at the seaward (distal) end of the ebb channel. This is the zone where the ebb jet velocity drops, resulting in sediment deposition (the expanding lobe shown in Figure 4-11).
- *Swash platforms*, which are sand sheets located between the main ebb channel and the adjacent barrier islands.
- *Swash bars* that form and migrate across the swash platforms because of currents (the swash) generated by breaking waves.
- *Marginal flood channels*, which flank both updrift and downdrift barriers.

Inlets with jetties often display these components, although marginal flood channels are usually lacking.

(b) For the Georgia coast, Oertel (1988) described a simple model of ebb-delta shape and orientation which depended on the balance of currents (Figure 4-16). With modifications, these models could apply to most inlets. When longshore currents were approximately balanced and flood currents exceeded ebb, a squat, symmetrical delta developed (Figure 4-16a) (example: Panama City, FL). If the prevailing longshore currents exceeded the other components, the delta developed a distinct northerly or southerly orientation (Figures 4-16b and 4-16c). Note that some of the Georgia ebb deltas change their orientation seasonally, trending north for part of the year and south for the rest. Finally, when inlet currents exceeded the forces of longshore currents, the delta was narrower

and extended further out to sea (Figure 4-16d) (example: Brunswick, GA).

(c) Based on studies of the German and Georgia bights, Nummedal and Fischer (1978) concluded that three factors were critical in determining the geometry of the inlet entrance and the associated sand shoals:

- Tide range.
- Nearshore wave energy.
- Bathymetry of the back-barrier bay.

For the German and Georgia bights the latter factor controls velocity asymmetry through the inlet gorge, resulting in greater seaward-directed sediment transport through the inlet than landward transport. This factor has aided the development of large ebb shoals along these coasts.

(d) The ebb-tidal deltas along mixed-energy coasts (e.g., East and West Friesian Islands of Germany, South Carolina, Georgia, Virginia, and Massachusetts) are huge reservoirs of sand. FitzGerald (1988) states that the amount of sand in these deltas is comparable in volume to that of the adjacent barrier islands. Therefore, on mixed-energy coasts, minor changes in volume of an ebb delta can drastically affect the supply of sand to the adjacent beaches. In comparison, on wave-dominated barrier coasts (e.g., Maryland, Outer Banks of North Carolina, northern New Jersey, Egypt's Nile Delta), ebb-tidal deltas are more rare and therefore represent a much smaller percentage of the overall coastal sand budget. As a result, volumetric changes in the ebb deltas have primarily local effects along the nearby beaches.

(e) Using data from tidal inlets throughout the United States, Walton and Adams (1976) showed that there is a direct correspondence between an inlet's tidal prism and the size of the ebb-tidal delta, with some variability caused by changes in wave energy. This research underscores how important it is that coastal managers thoroughly evaluate whether proposed structures might change the tidal prism, thereby changing the volume of the ebb-tide shoal and, in turn, affecting the sediment budget of nearby beaches.

(f) Ocean City, MD, is offered as an example of the effect of inlet formation on the adjacent coastline: the Ocean City Inlet was formed when Assateague Island was breached by the hurricane of 23 August 1933. The ebb-tide shoal has grown steadily since 1933 and now

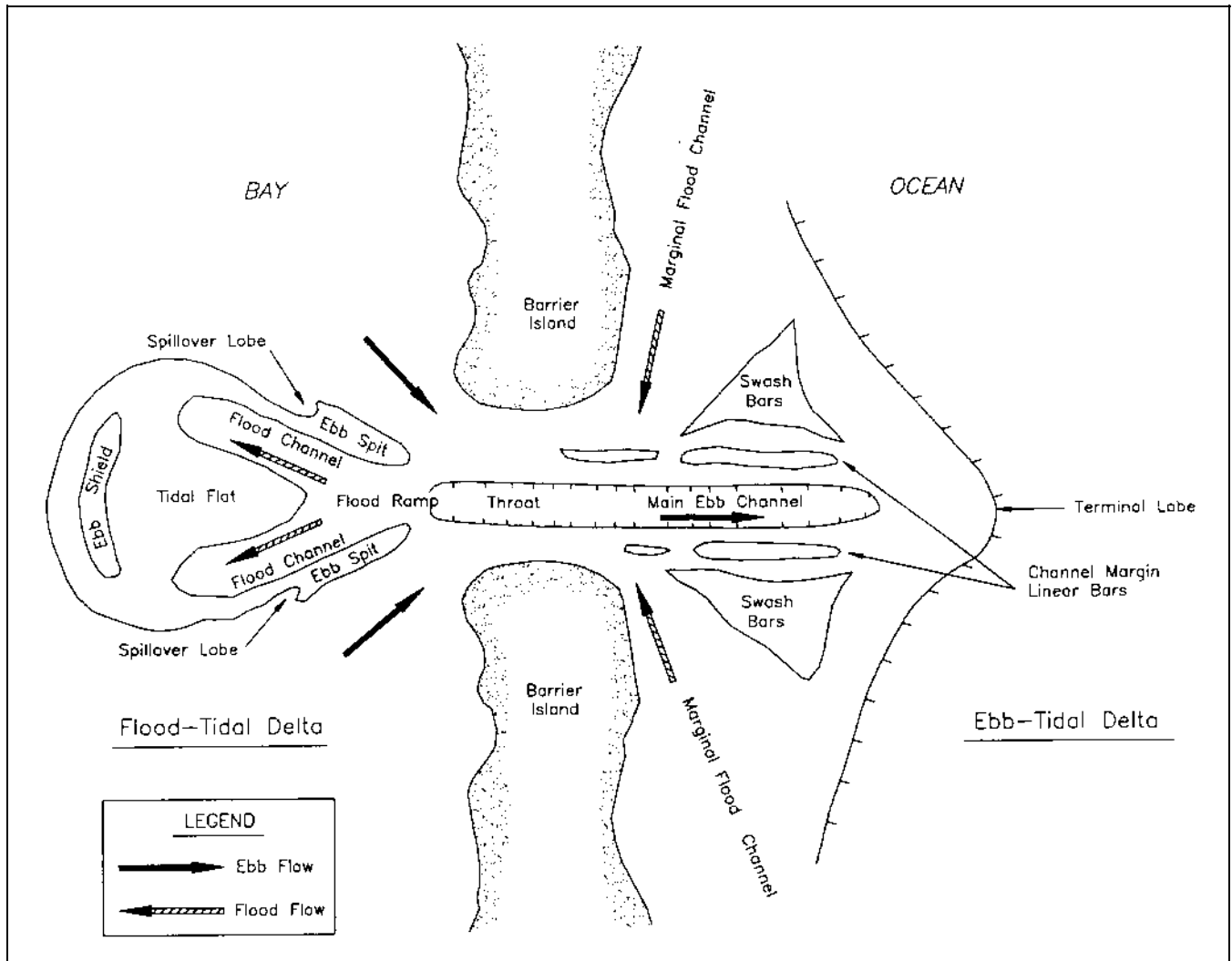

Figure 4-15. Geological model of a tidal inlet with well-developed flood and ebb deltas (from Boothroyd (1985) and other sources)

contains more than $6 \times 10^6 \text{ m}^3$ of sand, located a mean distance of 1,200 m offshore. Since 1933, the growth of the ebb delta combined with trapping of sand updrift of the north jetty have starved the downdrift (southern) beaches, causing the shoreline along the northern few kilometers of Assateague Island to retreat at a rate of 11 m/year (data cited in FitzGerald (1988)).

(g) In contrast to Ocean City, the decrease in inlet tidal prisms along the East Friesian Islands has been beneficial to the barrier coast. Between 1650 and 1960, the area of the bays behind the island chain decreased by 80 percent, mostly due to historic reclamation of tidal flats and marshlands (FitzGerald, Penland, and Nummedal 1984). The reduction in area of the bays reduced tidal

prisms, which led to smaller inlets, smaller ebb-tidal shoals, and longer barrier islands. Because of the reduced ebb discharge, less sediment was transported seaward. Waves moved ebb-tidal sands onshore, increasing the sediment supply to the barrier beaches.

(h) In many respects, ebb-tide deltas found at tidal inlets are similar to deltas formed at river mouths. The comparison is particularly applicable at rivers where the flow temporarily reverses during the flood stage of the tide. The main difference between the two settings is that river deltas grow over time, fed by fluviually supplied sediment. In contrast, at many tidal inlets, only limited sediment is supplied from the back bay, and the ebb deltas are largely composed of sand provided by longshore

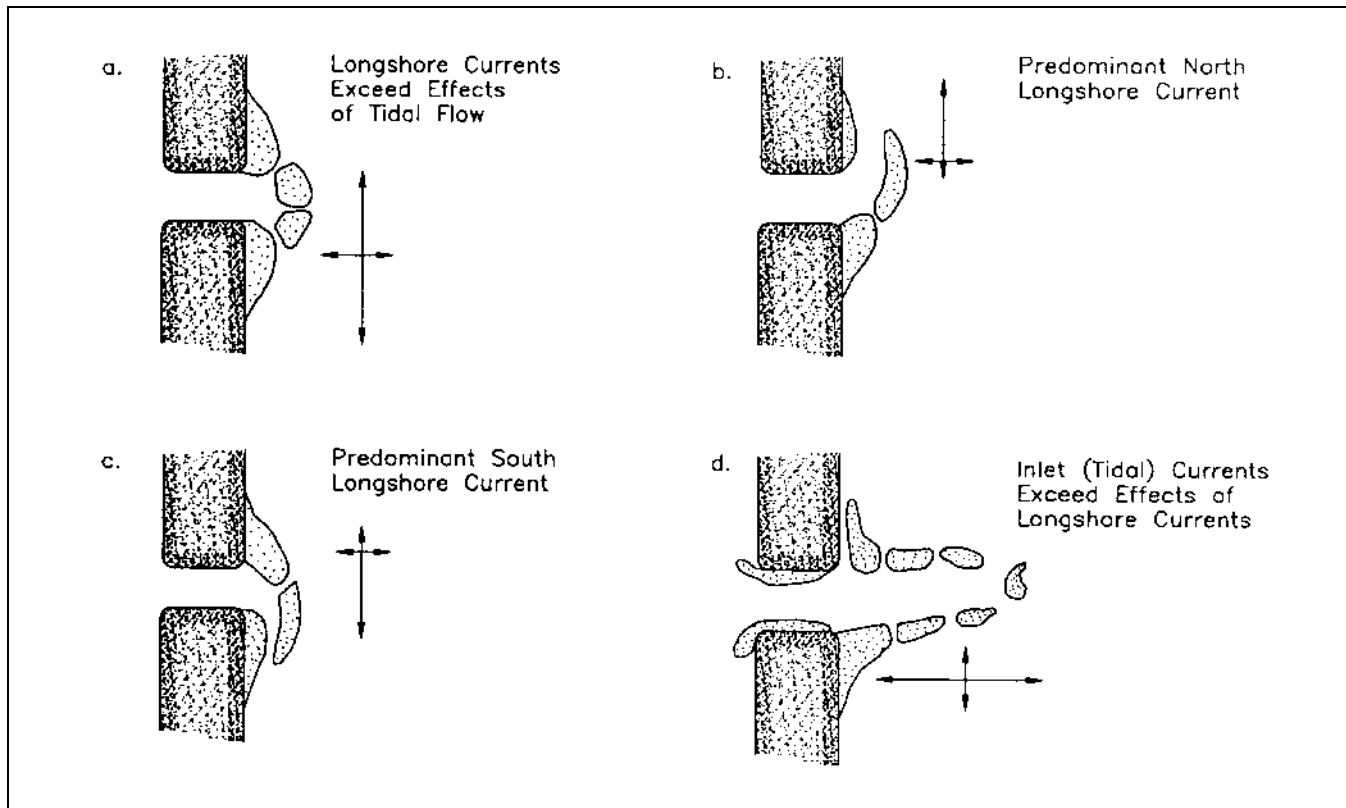

Figure 4-16. Four different shapes of tidal deltas, formed by the relative effects of longshore versus tidal currents (from Oertel (1988))

drift or reworked from the adjacent beaches. Under some circumstances, inlets and river mouths are in effect the same coastal form. During times of low river flow, the mouth assumes the characteristics of a tidal inlet with reversing tidal currents dominating sedimentation. During high river discharge, currents are unidirectional and fluvial sediment is deposited seaward of the mouth, where it can help feed the growth of a delta. Over time, a tidal inlet that connects a pond to the sea can be converted to a river mouth. This occurs when the back bay fills with fluvial sediment and organic matter. Eventually, rivers that formerly drained into the lagoon flow through channels to the inlet and discharge directly into the sea.

(2) Flood-tidal deltas (shoals).

(a) A model of a typical flood-tide shoal is shown in Figure 4-15. Flood shoals with many of these features have been described in meso- and micro-tidal environments around the world (Germany (Nummedal and Penland 1981), Florida's east coast (Stauble et al. 1988), Florida's Gulf of Mexico coast (Wright, Sonu, and Kielhorn 1972), and New England (Boothroyd 1985)). The major components are:

- The *flood ramp*, which is a seaward-dipping sand surface dominated by flood-tidal currents. Sediment movement occurs in the form of sand waves (dunes), which migrate up the ramp.
- *Flood channels*, subtidal continuations of the flood ramp.
- The *ebb shield*, the high, landward margin of the tidal delta that helps divert ebb-tide currents around the shoal.
- *Ebb spits*, high areas mainly formed by ebb currents with some interaction with flood currents.
- *Spillover lobes*, linguoid, bar-like features formed by ebb-tidal current flow over low areas of the ebb shield.

(b) Although this model was originally derived from studies in mesotidal, mixed-energy conditions, it appears to also be applicable to more wave-dominated, microtidal

inlets (Boothroyd 1985). However, flood-tide shoals apparently are not formed in macrotidal shores.

(c) The high, central portion of a flood-tidal delta often extends some distance into an estuary or bay. This is the oldest portion of the delta and is usually vegetated by marsh plants. The marsh cap extends up to the elevation of the mean high water. The marsh expands aerially by growing out over the adjacent tidal flat. The highest, marsh-covered part of a flood shoal, or sometimes the entire shoal, is often identified on navigation charts as a "middle ground."

*f. Sediment bypassing and inlet stability and migration.*¹

(1) Background. Inlets migrate along the coast - or remain fixed in one location - because of complex interactions between tidal prism, wave energy, and sediment supply. The littoral system is considered by some researchers to be the principal external sediment source that influences the stability of inlets (Oertel 1988). Not all of the sediment in littoral transport is trapped at the mouths of inlets; at many locations, a large proportion may be bypassed by a variety of mechanisms. Inlet sediment bypassing is defined as "the transport of sand from the updrift side of the tidal inlet to the downdrift shoreline" (FitzGerald 1988). Bruun and Gerritsen (1959) described three mechanisms by which sand moves past tidal inlets:

- Wave-induced transport along the outer edge of the ebb delta (the terminal lobe).
- The transport of sand in channels by tidal currents.
- The migration of tidal channels and sandbars.

They noted that at many inlets, bypassing occurred through a combination of these mechanisms. As an extension of this earlier work, FitzGerald, Hubbard, and Nummedal (1978) proposed three models to explain inlet sediment bypassing along mixed-energy coasts. The models are illustrated in Figure 4-17 and are discussed below.

(2) Inlet migration and spit breaching.

(a) The first model describes the tendency of many inlets to migrate downdrift and then abruptly shift their course by breaching a barrier spit. The migration occurs because sediment supplied by the longshore current causes the updrift barrier to grow (spit accretion). The growth occurs in the form of low, curved beach ridges, which weld to the end of the spit, often forming a bulbous-tipped spit known as a "drumstick." The ridges are often separated by low, marshy swales. As the inlet becomes narrower, the opposite (downdrift) shore erodes because tidal currents attempt to maintain an opening.

(b) In environments where the back bay is largely filled with marshes or where the barrier is close to the mainland, migration of the inlet causes an elongation of the tidal channel. Over time, the tidal flow between bay and ocean becomes more and more inefficient. Under these conditions, if a storm breaches the updrift barrier, the newly opened channel is a more direct and efficient pathway for tidal exchange. This new, shorter channel is likely to remain open while the older, longer route gradually closes. The breaching is most likely to occur across an area where the barrier has eroded or where some of the inner-ridge swales have remained low. The end result of spit accretion and breaching is the transfer of large quantities of sediment from one side of the inlet to the other. An example of this process is Kiawah River Inlet, SC, whose migration between 1661 and 1978 was documented by FitzGerald, Hubbard, and Nummedal (1978). After a spit is breached and the old inlet closes, the former channel often becomes an elongated pond that parallels the coast.

(c) Several notes apply to the inlet migration model: First, not all inlets migrate. As discussed earlier, some inlets on microtidal shores are ephemeral, remaining open only a short time after a hurricane forces a breach through the barrier. If the normal tidal prism is small, these inlets are soon blocked by littoral drift. Short-lived inlets were documented along the Texas coast by Price and Parker (1979). The composition of the banks of the channel and the underlying geology are also critical factors. If an inlet abuts resistant sediments, migration is restricted (for example, Hillsboro Inlet, on the Atlantic coast of Florida, is anchored by rock reefs). The gorge of deep inlets may be cut into resistant sediment, which also will restrict migration.

(d) Second, some inlets migrate updrift, against the direction of the predominate drift. Three mechanisms may account for updrift migration (Aubrey and Speer 1984):

¹ Material in this section has been adapted from FitzGerald (1988).

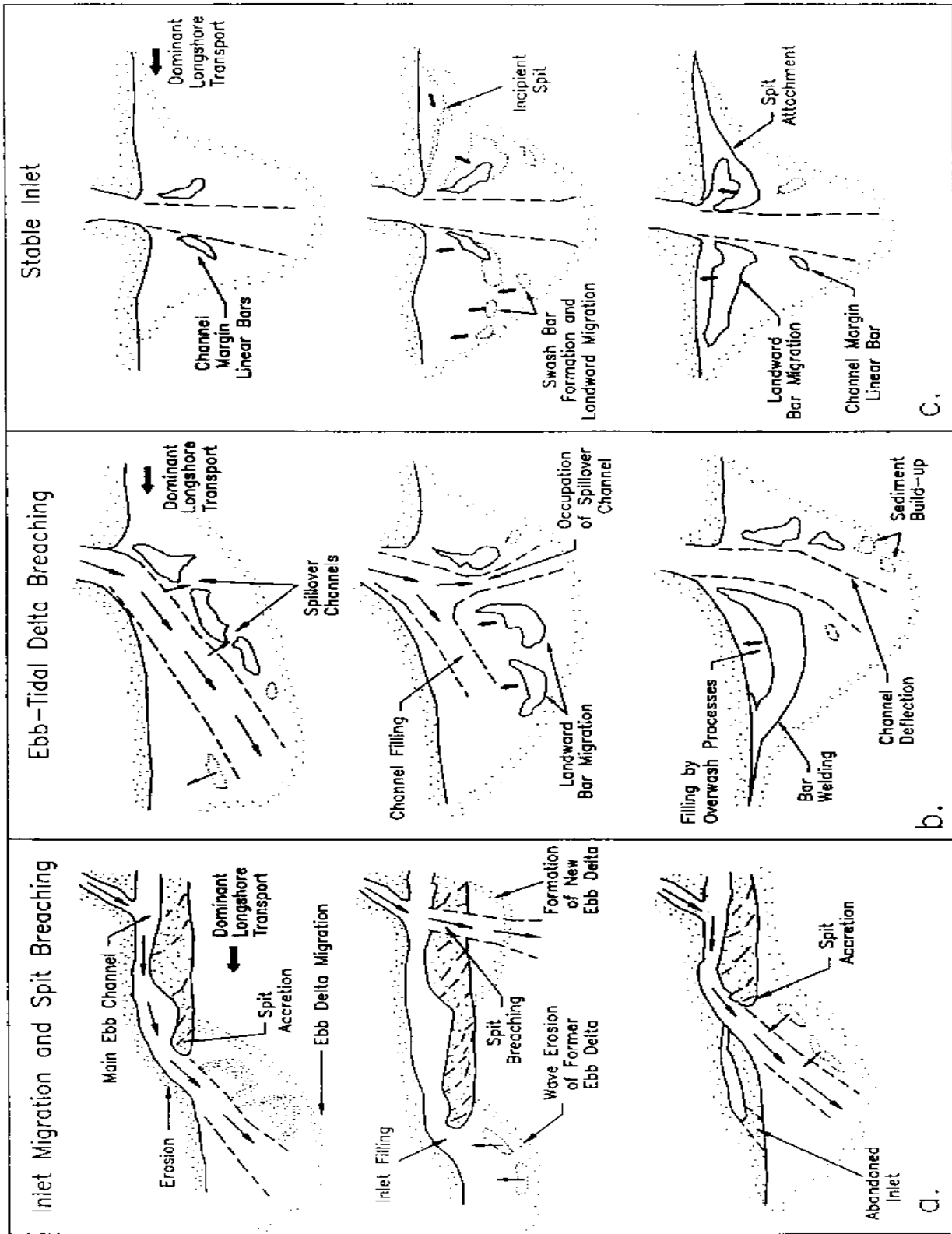

Figure 4-17. Three models of inlet behavior and sediment bypassing for mixed-energy coasts (adapted from FitzGerald (1988))

- Attachment of swash bars to the inlet's downdrift shoreline.
- Breaching of the spit updrift of an inlet.
- Cutbank erosion of an inlet's updrift shoreline caused by back-bay tidal channels that approach the inlet throat obliquely.

(3) Ebb-tidal delta breaching.

(a) At some inlets, the position of the throat is stable, but the main ebb channel migrates over the ebb delta (Figure 4-17b). This pattern is sometimes seen at inlets that are naturally anchored by rock or have been stabilized by jetties. Sediment supplied by longshore drift accumulates on the updrift side of the ebb-tidal delta, which results in a deflection of the main ebb channel. The ebb channel continues to deflect until, in some cases, it flows parallel to the downdrift shore. This usually causes serious beach erosion. In this orientation, the channel is hydraulically inefficient, and the flow is likely to divert to a more direct seaward route through a spillover channel. Diversion of the flow can occur gradually over a period of months or can occur abruptly during a major storm. Eventually, most of the tidal exchange flows through the new channel, and the abandoned old channel fills with sand.

(b) Ebb delta breaching results in the bypassing of large amounts of sand because swash bars, which had formerly been updrift of the channel, become downdrift after the inlet occupies one of the spillover channels. Under the influence of waves, the swash bars migrate landward. The bars fill the abandoned channel and eventually weld to the downdrift beach.

(4) Stable inlet processes.

(a) These inlets have a stable throat position and a main ebb channel that does not migrate (Figure 4-17c). Sand bypassing occurs by means of large bar complexes that form on the ebb delta, migrate landward, and weld to the downdrift shoreline (FitzGerald 1988). The bar complexes are composed of swash bars that stack and merge as they migrate onshore. Swash bars are wave-built accumulations of sand that form on the ebb delta from sand that has been transported seaward in the main ebb channel (Figure 4-15). The swash bars move landward because of the dominance of landward flow across the swash platform. The reason for landward dominance of flow is that waves shoal and break over the terminal

lobe (or bar) that forms along the seaward edge of the ebb delta. The bore from the breaking waves augments flood tidal currents but retards ebb currents.

(b) The amount of bypassing that actually occurs around a stable inlet depends upon the geometry of the ebb-tidal shoal, wave approach angle, and wave refraction around the shoal. Three sediment pathways can be identified:

- Some (or possibly much) of the longshore drift accumulates on the updrift side of the shoal in the form of a bar that projects out from the shore (Figure 4-17c). As the incipient spit grows, it merges with growing bar complexes near the ebb channel. Flood currents move some of the sand from the complexes into the ebb channel. Then, during ebb tide, currents flush the sand out of the channel onto the delta (both the updrift and downdrift sides), where it is available to feed the growth of new swash bars.
- Depending on the angle of wave approach, longshore currents flow around the ebb shoal from the updrift to the downdrift side. Some of the drift is able to move past the ebb channel, where it either continues moving along the coast or accumulates on the downdrift side of the ebb shoal.
- Wave refraction around some ebb shoals causes a local reversal of longshore current direction along the downdrift shore. During this time, presumably, little sediment is able to escape the confines of the ebb-tidal shoal.

(5) Extension of bypassing models to other environments. The inlet migration models described above were originally based on moderate- to high-energy shores. However, research along the Florida Panhandle suggests that the models may be applicable to much lower energy environments than the original authors had anticipated. For example, between 1870 and 1990, the behavior of East Pass inlet, located in the low wave-energy, microtidal Florida Panhandle, followed all three models at various times (Figure 4-18; Morang 1992b, 1993). It would be valuable to conduct inlet studies around the world to further refine the models and evaluate their applicability to different shores.

g. Inlet response to jetty construction and other engineering activities.

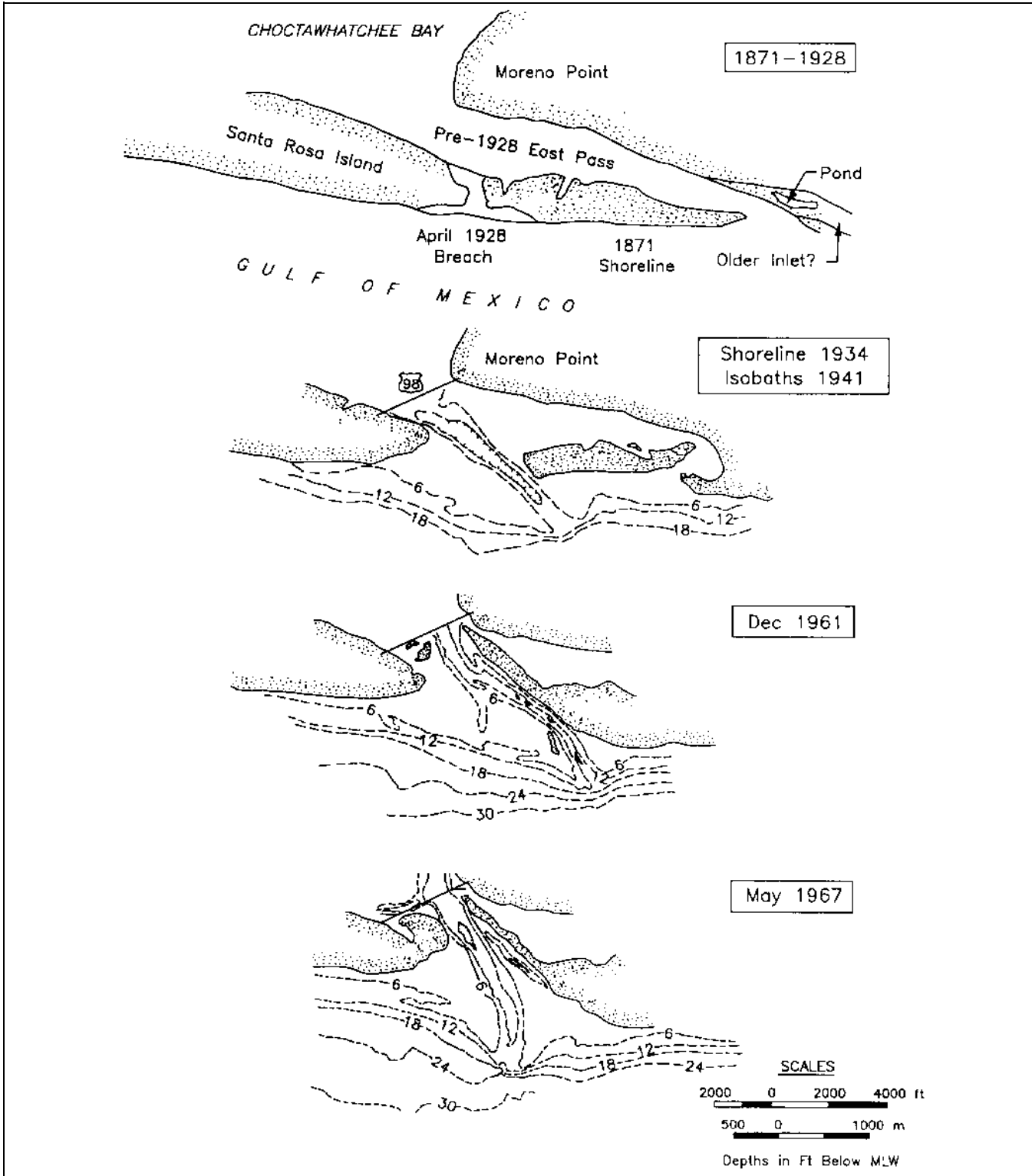

Figure 4-18. Spit breaching and inlet migration at East Pass, Florida (from Morang (1992b))

(1) Introduction. Typically, jetties are built at a site to stabilize a migrating inlet, to protect a navigation channel from waves, or to reduce the amount of dredging required to maintain a specified channel depth. However, jetties can profoundly affect bypassing and other processes at the mouths of inlets. Some of these effects can be predicted during the design phase of a project. Unfortunately, unanticipated geological conditions often arise, which lead to problems such as increased shoaling or changes in the tidal prism. Several classes of man-made activities affect inlets:

- Jetties stabilize inlets and prevent them from migrating.
- Jetties can block littoral drift.
- Walls or revetments can change the cross section of an inlet.
- Dredging can enlarge the cross section of a gorge.
- Dam construction and freshwater diversion reduce fluvial input.
- Weir sections (low portions of a jetty) allow sediment to pass into an inlet, where it can accumulate in a deposition basin and be bypassed.
- Landfilling and development in estuaries and bays can reduce tidal prism.

(2) Technical literatures. Many reports have documented the effects of jetties on littoral sediment transport. Early works are cited in Barwis (1976). Weirs and other structures are discussed in the *Shore Protection Manual* (1984). Dean (1988) discussed the response of modified Florida inlets, and many other case studies are reviewed in Aubrey and Weishar (1988). Examples of monitoring studies conducted to assess the effects of jetties include:

- Ocean City Inlet, Maryland (Bass et al., 1994).
- Little River Inlet, North and South Carolina (Chasten 1992, Chasten and Seabergh 1992).
- Murrells Inlet, South Carolina (Douglass 1987).
- St. Marys Entrance, Florida and Georgia (Kraus, Gorman, and Pope, 1994).
- East Pass, Florida (Morang 1992a).

- Port Mansfield Channel, Texas (Kieslich 1977).

(3) General inlet response.

(a) A model of the response of an ebb-tidal delta to jetty construction is shown in Figure 4-19. The first panel shows a natural inlet in a setting where the predominant drift direction is from right to left. The second panel shows the morphology after the jetties have been completed. At this time, sediment is accumulating on the updrift side of the channel because the updrift jetty (on the right) acts like a groin. As the new ebb delta grows, the abandoned tidal channel fills with sand, and swash bars on the former ebb delta migrate landward. With time, wave action erodes the former ebb delta, particularly if it is out of the sheltering lee of the jetties.

(b) The third panel shows the system after a new ebb delta has formed around the jetties. If the jetties are built across the old delta, then it essentially progrades seaward. If the jetties are built at a different site, then the abandoned ebb delta erodes and disappears while a new delta progrades out from the shore. At some projects, an abandoned ebb delta will disappear within a few years, even on low wave energy shores. The development of a new delta appears to take longer; while the initial growth is rapid, continued adjustment and growth occur for decades. The Charleston Harbor inlet has taken decades to respond to the jetties, which were constructed between 1879 and 1898 (Hansen and Knowles 1988).

(4) Interruption of sediment transport at engineered inlets.

(a) At most sites, the designers of a project must ensure that the structures do not block the littoral drift; otherwise, severe downdrift erosion can occur. Dean (1988) used the phrase "sand bridge" to describe the off-shore bar (terminal lobe) across the mouth of most inlets. Net longshore sand transport occurs across the bridge. If the bar is not sufficiently broad and shallow, sediment is deposited until an effective sand bridge is reestablished. Unfortunately, this concept suggests that maintenance of a permanent channel deep enough for safe navigation is usually inconsistent with sediment transport around the entrance by natural processes. Sand bypassing using pumps or dredges can mitigate many of the negative effects of inlet jetties and navigation channels (EM 1110-2-1616).

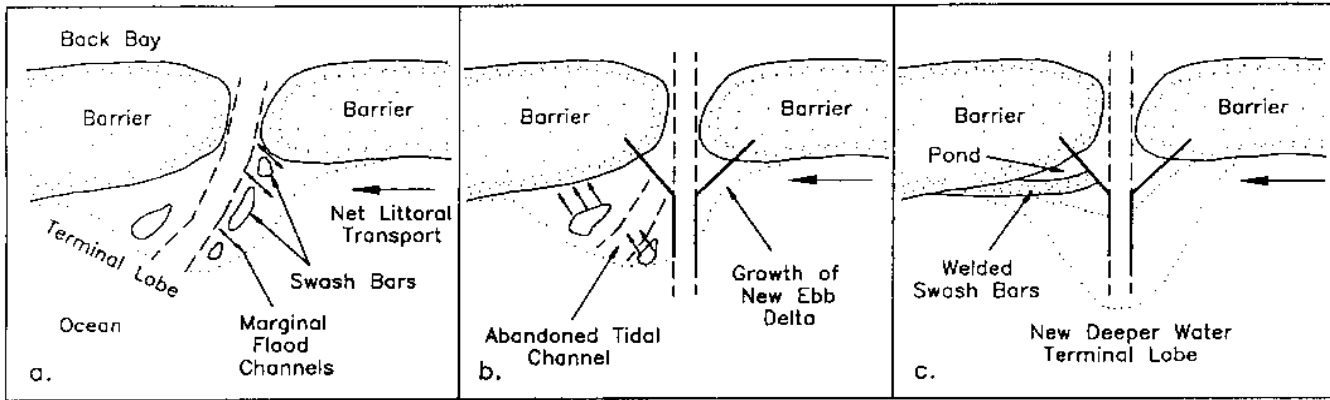

Figure 4-19. Model of the response of an ebb-tidal delta to jetty construction. The final result is development of a new ebb delta seaward of the mouth of the jetties in deeper water than the original delta (adapted from Hansen and Knowles 1988)

(b) Dean (1988) also described the “sand sharing system” concept, which states that the sand bodies comprising an inlet, ebb-tidal shoal, and adjacent shorelines are interconnected and in equilibrium. In effect, an ebb shoal is in balance with the local shorelines, and any removal of sand from the shoal lowers the shoal’s elevation, thereby causing a flow of sand to restore the local equilibrium. Some of this sand might be eroded from the nearby beaches. Dean (1988) proposed an axiom pertaining to a shoreline sand-sharing system:

If sand is removed or blocked from a portion of the sand sharing system, the system will respond to restore equilibrium by transporting sand to the deficient area. The adverse erosional effect on the remainder of the system by this removal or blockage is certain, only the timing and degree of its manifestation are in doubt.

(c) Most engineering activities at inlets have some effect on the distribution of sediment. These effects are summarized in Table 4-1 and described in greater detail below.

(d) Storage against updrift jetty. A sand-tight jetty on the updrift side of an inlet will trap sand until the impoundment capacity is reached. If no mechanism has been incorporated into the project to bypass sediment, such as a weir section or a bypassing pumping station, the downdrift shoreline must erode at the same rate as the impoundment at the updrift jetty. This causes a redistribution of sediment, but not a net loss.

(e) Ebb-tidal shoal growth. When an existing inlet is modified by the addition of jetties, the ebb delta is often displaced further seaward to deeper water. The result is

Table 4-1
Mechanisms Which Affect Sediment Budget of Shorelines Adjacent to Modified (Engineered) Tidal Inlets

Mechanism	Does Mechanism Cause a Net Deficit to Adjacent Shorelines?
1. Storage against updrift jetty	No
2. Ebb tidal shoal growth	Possibly
3. Flood tide shoal growth	Yes
4. Dredge disposal in deep water	Definitely
5. Leaky jetties	Can contribute sediment to nearby shorelines
6. Jetty “shadows”	No
7. Geometric control	No

Note: (From Dean (1988))

that the delta grows greatly in volume. This process may not always occur, depending on tidal prism and wave climate. For example, Hansen and Knowles (1988) concluded that the construction of jetties was eliminating the typical ebb-tidal delta morphology at Murrell’s and Little River inlets in South Carolina. In contrast, at East Pass, Florida, the ebb delta has continued to grow seaward beyond the end of the jetties (Morang 1992a).

(f) Flood-tidal shoal growth. Flood-tide shoals can contain large amounts of sand transported from the adjacent shorelines. Under most circumstances, this sand is lost from the shoreface because there are few natural mechanisms which agitate a flood shoal to a great extent and carry the sand back out to sea. Major rainstorms can raise water elevations in back bays and greatly increase ebb flow, but even under these circumstances, much of

the flood shoal is likely to remain. An exception may occur when an inlet is hardened, allowing the prism to increase. If jetties block incoming sand, the system may become sand starved and, over time, much of the flood shoal may be flushed out by the ebb flow.

(g) Dredge disposal in deep water. Until recently, much high-quality sand was dredged from navigation channels and disposed in deep water, where it was lost from the littoral zone. This was an unfortunate practice because beach sand is an extremely valuable mineral resource and is in short supply. Many states now require that all uncontaminated, beach-quality dredged sand be used for beach renourishment.

(h) Leaky jetties. Jetties with high permeability allow sand carried by longshore currents to pass into the channel. Dean (1988) states that this can result in increased erosion of both the updrift and downdrift beaches, whereas sand-tight jetties cause a redistribution, but not a net loss, of sand. However, if material that passes through leaky jetties is dredged and deposited on the adjacent beaches, the erosional impact is minimized. This is similar to the concept of a weir, which allows sand to pass into a deposition basin, where it can be dredged on a regular schedule.

(i) Jetty shadows. Sediment transported around an inlet (both modified and natural), may not reach the shore until some distance downdrift from the entrance. This results in a shadow zone where there may be a deficit of sediment.

(j) Geometric control. This refers to the refraction of waves around an ebb-tidal delta, resulting in local changes to the regional longshore drift pattern. A common result is that for some distance downdrift of a delta, the net drift is reversed and flows towards the delta, while further away from the delta, the drift moves in the opposite direction. The zone of divergence may experience erosion.

h. Summary. This section has discussed some of the many physical processes associated with water flow through tidal inlets. This complex topic has been the subject of a voluminous technical literature, of which it has been possible to cite only a few works. The following are among many interacting processes which affect sedimentation patterns in and near tidal inlets:

- Tidal range.
- Tidal prism - affects quantity of water flowing through the inlet.

- Wave energy - radiation stress drives longshore drift.
- Longshore drift - supplies sediment to vicinity of inlet.
- Fluvial input - affects stratification and sediment supply.
- Man-made intervention - dams upriver reduce sediment and fluvial input; jetties interrupt longshore drift.
- Meteorology - affects offshore water levels.

Recent research at tidal inlets around the world is enhancing our knowledge about these dynamic features of the coastline, but has also made it apparent that there is still much to learn with respect to engineering and management practices.

4-5. Morphodynamics and Shoreface Processes of Clastic Sediment Shores

a. Overview.

(1) Introduction. This section discusses morphodynamics - the interaction of physical processes and geomorphic response - of clastic sediment shores. The topic covers beach features larger than a meter (e.g., cusps and bars) on time scales of minutes to months. Details on grain-to-grain interactions, the initiation of sediment motion, and high frequency processes are not included. A principle guiding this section is that the overall shape of beaches and the morphology of the shoreface are largely a result of oscillatory (gravity) waves, although tide range, sediment supply, and overall geological setting impose limits. We introduce basic relationships and formulas, but the text is essentially descriptive. A brief introduction to waves has been presented in Chapter 2, Paragraph 2-5*b*; Chapter 5, Paragraph 5-5 gives details on the use of wave records.

(2) Literature. Beaches and sediment movement along the shore have been subjects of popular and scientific interest for over a century. A few of the many textbooks that cover these topics include Carter (1988), Davis (1985), Davis and Ethington (1976), Greenwood and Davis (1984), Komar (1976), and Zenkovich (1967). Small-amplitude (Airy) and higher-order wave mechanics are covered in EM 1110-2-1502; more detailed treatments are in Kinsman (1965), Horikawa (1988), and

Le Méhauté (1976). Interpreting and applying wave and water level data are covered in EM 1110-2-1414.

(3) Significance of clastic coasts. It is important to examine and understand how clastic shores respond to changes in wave climate, sediment supply, and engineering activities for economic and management reasons:

- Beaches are popular recreation areas.
- Beaches are critical buffer zones protecting wetlands and coastal plains from wave attack.
- Many people throughout the world live on or near beaches.
- Much engineering effort and expense are expended on planning and conducting beach renourishment.
- Sediment supply and, therefore, beach stability, is often adversely affected by the construction of navigation structures.
- Sand is a valuable mineral resource throughout most of the coastal United States.

(4) Geologic range of coastal environments. Around the world, the coasts vary greatly in steepness, sediment composition, and morphology. The most dynamic shores may well be those composed of unconsolidated clastic sediment because they change their form and state rapidly. Clastic coasts are part of a geologic continuum that extends from consolidated (rocky) to loose clastic to cohesive material (Figure 4-20). Waves are the primary mechanism that shape the morphology and move sediment, but geological setting imposes overall constraints by controlling sediment supply and underlying rock or sediment type. For example, waves have little effect on rocky cliffs; erosion does occur over years, but the response time is so long that rocky shores can be treated as being geologically controlled. At the other end of the continuum, cohesive shores respond very differently to wave action because of the electro-chemical nature of the sediment.

b. Tide range and overall beach morphology.

Most studies of beach morphology and processes have concentrated on microtidal (< 1 m) or low-mesotidal coasts (1-2 m). To date, many details concerning the processes that shape high-meso- and macrotidal beaches (tide range > 2 m) are still unknown. Based on a review of the literature, Short (1991) concluded that

wave-dominated beaches where tide range is greater than about 2 m behave differently than their lower-tide counterparts. Short underscored that high-tide beaches are also molded by wave and sediment interactions. The difference is the increasing impact of tidal range on wave dynamics, shoreface morphodynamics, and shoreline mobility. Short developed a tentative grouping of various beach types (Figure 4-21). Discussion of the various shoreface morphologies follows: Section 4-5c describes coasts with tide range greater than about 2 m. Low tide-range shores, described by a model presented by Wright and Short (1984), are discussed in Section 4-5d.

c. High tidal range (> 2 m) beach morphodynamics.

(1) Review. Based on a review of earlier research on macrotidal beaches, Short (1991) summarized several points regarding their morphology:

- They are widespread globally, occurring in both sea and swell environments.
- Incident waves dominate the intertidal zone.
- Low-frequency (infragravity) standing waves may be present and may be responsible for multiple bars.
- The intertidal zone can be segregated into a coarser, steeper, wave-dominated high tide zone, an intermediate zone of finer sediment and decreasing gradient, and a low-gradient, low-tide zone. The highest zone is dominated by breaking waves, the lower two by shoaling waves.
- The cellular rip circulation and rhythmic topography that are so characteristic of micro-tidal beaches have not been reported for beaches with tide range greater than 3 m.

(2) Macrotidal beach groups. Using published studies and field data from Australia, Short (1991) divided macrotidal beaches into three groups based on gradient, topography, and relative sea-swell energy:

(a) GROUP 1 - High wave, planar, uniform slope. Beaches exposed to persistently high waves ($H_b > 0.5$ m) display a planar, flat, uniform surface (Figure 4-21). Shorefaces are steep, ranging from 1 to 3 deg, and have a flat surface without ripples, bed forms, or bars. The upper high tide beach is often relatively steep and cuspid and contains the coarsest sediment of the system. On

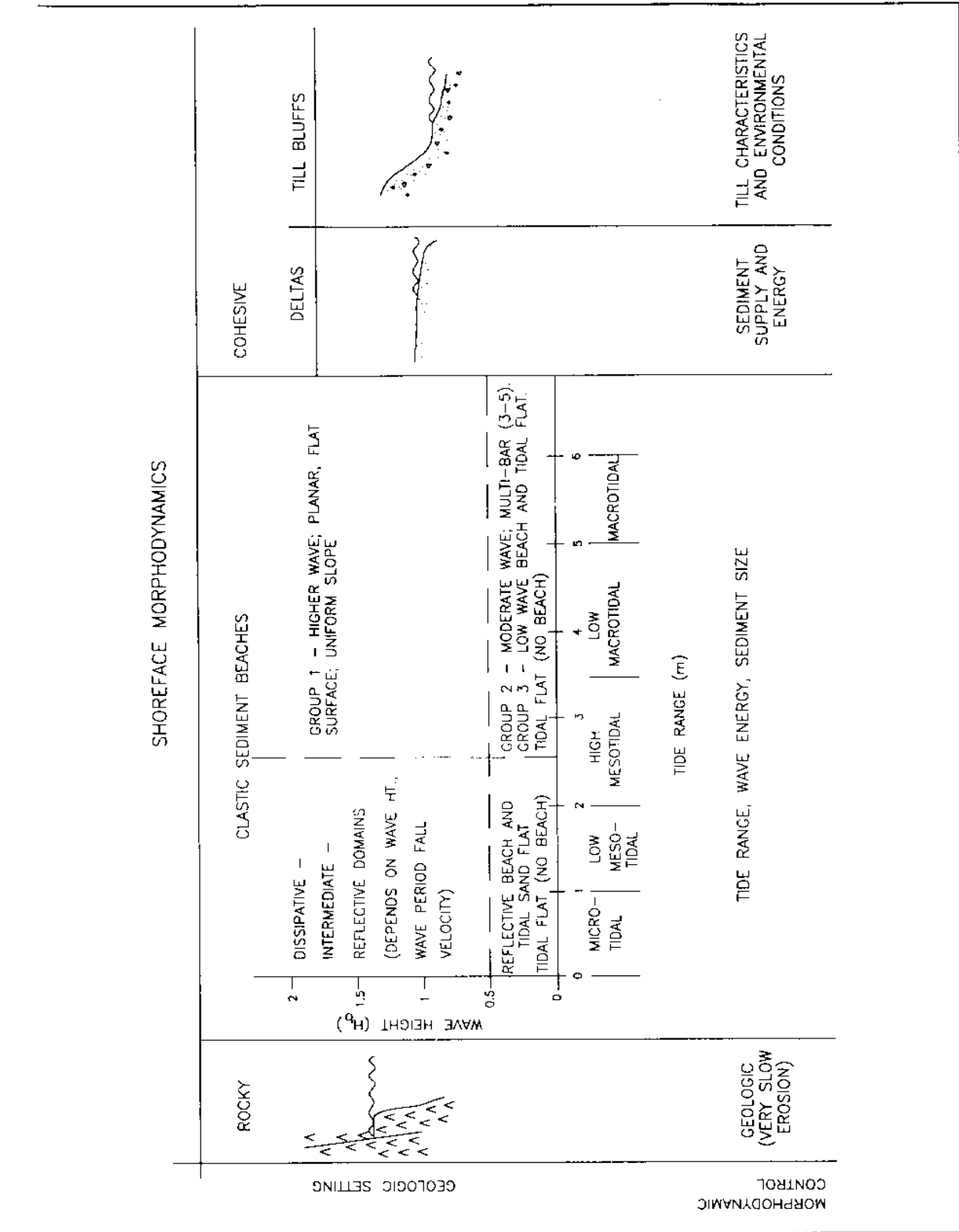

Figure 4-20. Summary of factors controlling morphodynamics along a range of coastal types. Clastic shore morphodynamics are detailed in Figure 4-21 and discussed in the text

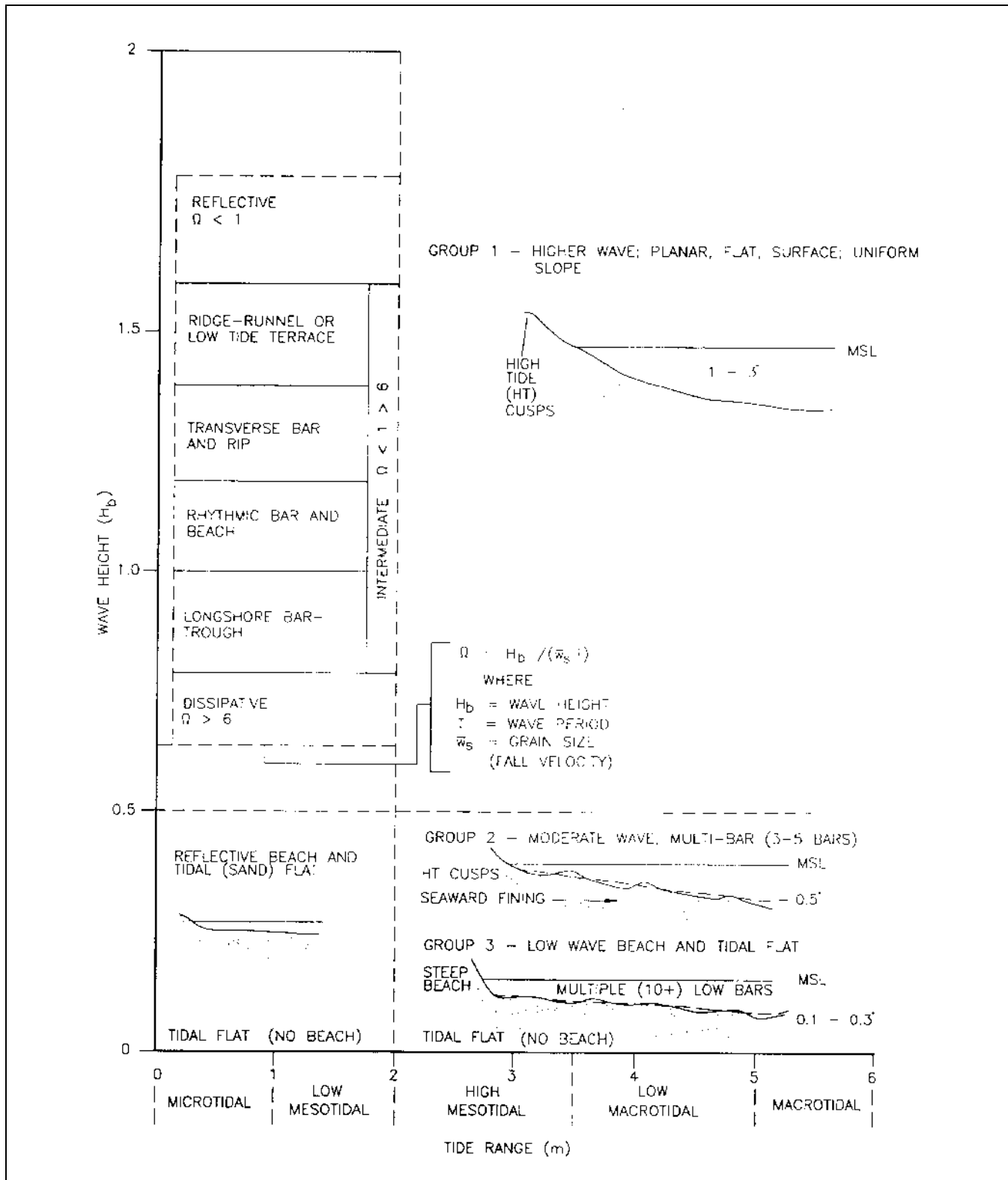

Figure 4-21. Micro- to macrotidal beach and tidal flat systems (adapted from Short (1991)). Dimensionless parameter Ω discussed in the text

both sand and gravel beaches, the high tide, upper foreshore zone is exposed to the highest waves. Plunging and surging breakers produce asymmetric swash flows, which maintain the coarse sediment and steep gradient. Further seaward, wave shoaling becomes a more important factor than wave breaking because waves are attenuated at low tide (due to shallower water and greater friction). Tidal currents also increase in dominance seaward. Wright (1981) found that tidal currents left no bed forms visible at low tide but were an important factor in longshore sediment transport.

(b) GROUP 2 - Moderate wave, multi-bar. Multi-bar, macrotidal beaches are formed in fetch-limited environments with high tide range and abundant fine sand (King 1972). The common characteristic of these beaches is a relatively uniform 0.5- to 0.6-deg intertidal gradient and the occurrence of multiple bars (two to five sets) between msl and mlw (Short 1991). Bar amplitude is usually below 1 m and spacing ranges from 50 to 150 m, with spacing increasing offshore. Field observations indicate that the bars are formed by a wave mechanism, particularly during low wave, post-storm conditions. The bars appear to build up onsite rather than migrate into position. These multi-bar beaches probably cause dissipative conditions during most wave regimes, possibly resulting in the development of infragravity standing waves. This would account for the spacing of the bars; however, this hypothesis has not been tested with rigorous field measurements (Short 1991).

(c) GROUP 3 - Low wave beach and tidal flat. As wave energy decreases, macro-tidal beaches eventually grade into tide-dominated tidal flats. Between the two regimes, there is a transition stage that contains elements of both morphologies. These beach-tidal flat systems are usually characterized by a steep, coarse-grained reflective beach (no cusps usually present) which grades abruptly at some depth below msl into a fine-grained, very low gradient (0.1 deg), rippled tidal flat. The tidal flat may be uniform or may contain low, multiple bars. Beach-tidal flat shores are found in low-energy environments that are only infrequently exposed to wave attack, but the energy must be sufficient to produce the morphologic zonation.

(3) Spatial and temporal variations. Beaches on macro-tidal coasts vary morphologically as important environmental parameters change. Short (1991) cites one setting where the shoreface varies from high-energy, uniform steep beach (Group 1) to beach-tidal flat (Group 3) within 2 km. He suggests that the changes in morphology are due to variations in wave energy: as energy changes alongshore, important thresholds are crossed which result

in different ratios of wave versus tide domination. In addition, there may be temporal variations throughout the lunar cycle. As tide range varies during the month, the transitions where one morphologic group merges into another may migrate cyclically along the coast. More field studies are needed to document this phenomenon.

(4) Summary. On tideless beaches, morphology is determined by waves and sediment character. On microtidal beaches, waves still dominate the morphodynamics, but tide exerts a greater influence. As tide range increases beyond 2-3 m, the shape of beaches becomes a function of waves coupled with tides. On the higher tide coasts, as water depth changes rapidly throughout the day, the shoreline and zone of wave breaking move horizontally across the foreshore and tidal currents move considerable sediment.

d. Morphodynamics of micro- and low-mesotidal coasts.

(1) Morphodynamic variability of microtidal beaches and surf zones. Based on field experiments in Australia, Wright and Short (1984) have presented a model of shoreface morphology as a function of wave parameters and sediment grain size. This model is a subset of Figure 4-21 that occupies the zone where tide range is between 0 and 2 m and H_b (breaker height) is greater than about 0.5 m.

(a) Wright and Short (1984) determined that the morphodynamic state of sandy beaches could be classified on the basis of assemblages of depositional forms and the signatures of associated hydrodynamic processes. They identified two end members of the morphodynamic continuum:

- Fully dissipative.
- Highly reflective. Between the extremes were four intermediate states, each of which possessed both reflective and dissipative elements (Figure 4-22).

(b) The most apparent differences between the beach states are morphological, but distinct process signatures, representing the relative velocities of different modes of fluid motion, accompany the characteristic morphology. As stated by Wright and Short (1984):

Although wind-generated waves are the main source of the energy which drives beach changes, the complex processes, which operate in

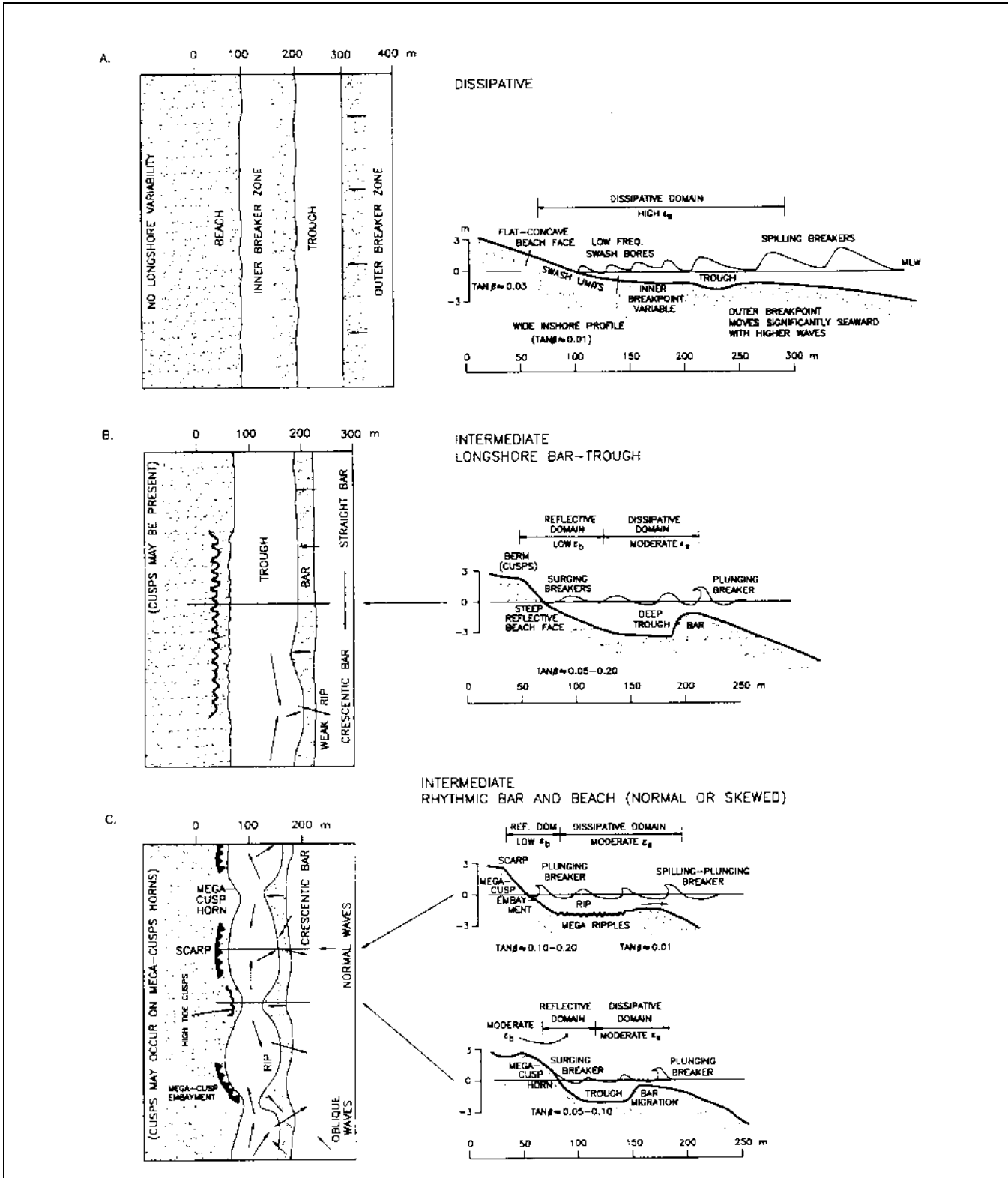
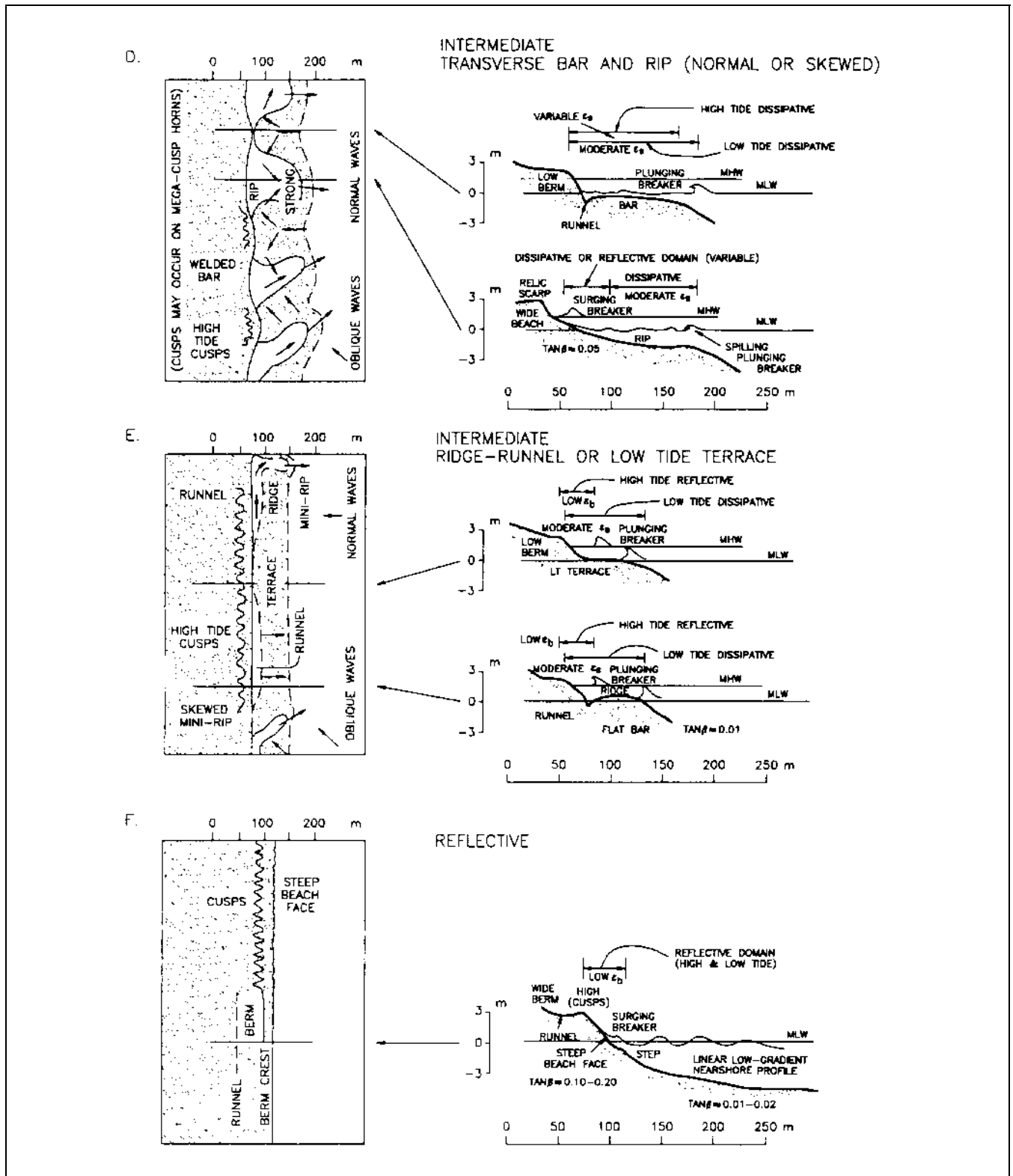

Figure 4-22. Plan and profile views of six major beach stages (adapted from Wright and Short (1984)). Surf-scaling parameter ϵ is discussed in the text; β represents beach gradient. Dimensions are based on Australian beaches, but morphologic configurations are applicable to other coastlines (Continued)



natural surf zones and involve various combinations of dissipation and reflection, can lead to the transfer of incident wave energy to other modes of fluid motion, some of which may become dominant over the waves themselves.

Wright and Short grouped fluid motion into four categories (Table 4-2):

- Oscillatory flows.
- Oscillatory or quasi-oscillatory flows.
- Net circulations.
- Non-wave-generated currents.

(c) From repeated observations and surveys of beaches, Wright and Short (1984) concluded that beach

state is clearly a function of breaker height and period and sediment size. Over time, a given beach tends to exhibit a *modal* or most frequent recurrent state, which depends on environmental conditions. Variations in shoreline position and profile are associated with temporal variations of beach state around the modal state. Wright and Short found that a dimensionless parameter Ω could be used to describe the modal state of the beach:

$$\Omega = \frac{H_b}{\bar{w}_s T} \quad (4-3)$$

where H_b is breaker height, \bar{w}_s is sediment fall velocity, and T is wave period. A value of Ω about 1 defines the reflective/intermediate threshold; for intermediate beaches, $1 < \Omega < 6$; $\Omega \sim 6$ marks the threshold between intermediate and dissipative conditions (Figure 4-22).

Table 4-2
Modes of Fluid Motion Affecting Clastic Shorelines

Modes	Notes	Frequencies of flows	Examples
Oscillatory	Corresponds directly to incident waves	Frequency band of deep-water incident waves	Sediment-agitating oscillations
Oscillatory or quasi-oscillatory	Shore-normal oriented standing and edge waves	Wide range of frequencies	Trapped edge waves, "leaky" mode standing waves
Net circulations	Generated by wave energy dissipation	Minutes to days	Longshore currents, rip currents, rip feeder currents
Non-wave-generated currents	Generated by tides and wind shear	Minutes to hours (?)	Tidal currents

(Based on Wright and Short (1984))

(d) Beaches take time to adjust their state, and a change of Ω across a threshold boundary does not immediately result in a transformation from reflective to intermediate or from intermediate to dissipative. On the Pacific coasts of Australia and the United States, storms can cause a shift of beach state from reflective or intermediate to dissipative in a few days because the energy is high. The return to reflective conditions under low energy may require weeks or months or longer (the sequence of beach recovery is illustrated in stages a through f in Figure 4-22). In environments where the dominant variation in wave energy occurs on an annual cycle (e.g., high storm waves in winter and low swell in summer), the full range from a dissipative winter profile to a reflective summer profile may be expected.

(e) Wright and Short (1984) concluded that, in general, large temporal variations in Ω are accompanied by

large changes in state. However, when the variations in Ω take place in the domains of $\Omega < 1$ or $\Omega > 6$, no corresponding changes in *state* result. Intermediate beaches, where Ω is between 1 and 6, are spatially and temporally the most dynamic. They can undergo rapid changes as wave height fluctuates, causing reversals in onshore/offshore and alongshore sediment transport.

(f) The parameter Ω depends critically upon \bar{w}_s , the sediment fall velocity. It is unclear how the relationships described above apply to shorefaces where the grain size varies widely or where there is a distinct bimodal distribution. For example, many Great Lakes beaches contain material ranging in size from silt and clay to cobble several centimeters in diameter. During storms, not only do wave height and period change, but fine-grain sediment is preferentially removed from the shoreface; therefore, the effective \bar{w}_s may change greatly within a few hours.

Further research is needed to understand how Great Lakes beaches change modally and temporally.

(2) Highly dissipative stage (Figure 4-22a). The dissipative end of the continuum is analogous to the “storm” or “winter beach” profile described by Bascom (1964) for shores that vary seasonally. The characteristic feature of these beaches is that waves break by spilling and dissipating progressively as they cross a wide surf zone, finally becoming very small at the upper portion of the foreshore (Figure 4-23) (Wright and Short 1984). A dissipative surf zone is broad and shallow and may contain two or three sets of bars upon which breakers spill. Longshore beach variability is minimal.

(3) Highly reflective stage (Figure 4-22f). On a fully reflective beach, breakers impinge directly on the shore without breaking on offshore bars (Figures 4-24, 4-25). As breakers collapse, the wave uprush surges up a steep foreshore. At the bottom of the steep, usually linear beach is a pronounced step composed of coarser material. Seaward of the step, the slope of the bed decreases appreciably. Rhythmic beach cusps are often present in the swash

zone. The fully reflective stage is analogous to the fully accreted “summer profile.”

(4) Surf-scaling parameter. Morphodynamically, the two end members of the beach state model can be distinguished on the basis of the surf-scaling parameter (Guza and Inman 1975):

$$\epsilon = \frac{a_b \omega^2}{g \tan^2 \beta} \quad (4-4)$$

where

a_b = breaker amplitude

ω = incident wave radian energy ($2\pi/T$ where T = period)

g = acceleration of gravity

β = the gradient of the beach and surf zone



Figure 4-23. Example of a dissipative beach: Southern California near San Diego



Figure 4-24. Example of a reflective sand beach: Newport Beach, CA, April, 1993

Strong reflection occurs when $\epsilon \leq 2.0-2.5$; this situation defines the highly reflective extreme. When $\epsilon > 2.5$, waves begin to plunge, dissipating energy. Finally, when $\epsilon > 20$, spilling breakers occur, the surf zone widens, and turbulent dissipation of wave energy increases with increasing ϵ .

(5) Intermediate beach stages. These stages exhibit the most complex morphologies and process signatures.

(a) Longshore bar-trough state (Figure 4-22b). This beach form can develop from an antecedent dissipative profile during an accretionary period. Bar-trough relief is higher and the shoreface is much steeper than on the dissipative profile. Initial wave breaking occurs over the bar. However, in contrast to the dissipative beach, the broken waves do not continue to decay after passing over the steep inner face of the bar, but re-form in the deep trough. Low-steepness waves surge up the foreshore; steeper waves collapse or plunge at the base of the foreshore, followed by a violent surge up the subaerial beach (Wright and Short 1984). Runup is relatively high and cusps often occur in the swash zone.

(b) Rhythmic bar and beach (Figure 4-22c). Characteristics are similar to the longshore bar-trough state

(described above). The distinguishing features of the rhythmic bar and beach state are the regular longshore undulations of the crescentic bar and of the subaerial beach (Figure 4-26). A weak rip current circulation is often present, with the rips flowing across the narrow portions of the bar. Wright and Short (1984) state that incident waves dominate circulation throughout the surf zone, but subharmonic and infragravity oscillations become important in some regions.

(c) Transverse-bar and rip state (Figure 4-22d). This morphology commonly develops in accretionary sequences when the horns of crescentic bars weld to the beach. This results in dissipative transverse bars (sometimes called "mega-cusps") that alternate with reflective, deeper embayments. The dominant dynamic process of this beach state is extremely strong rip circulation, with the seaward-flowing rip currents concentrated in the embayments.

(d) Ridge and runnel/low tide terrace state (Figures 4-22e and 3-21). This beach state is characterized by a flat accumulation of sand at or just below the low tide level, backed by a steeper foreshore. The beach is typically dissipative at low tide and reflective at high tide.



Figure 4-25. Example of a reflective cobble beach: Aldeburgh, Suffolk (facing the North Sea), August 1983. Note the steep berm and the lack of sand-sized sediment

e. Processes responsible for shoreface sediment movement.

(1) Despite intense study for over a century, the subject of sand movement on the shoreface is still poorly understood. Sand is moved by a combination of processes including (Pilkey 1993; Wright et al. 1991):

- Wave orbital interactions with bottom sediments and with wave-induced longshore currents.
- Wind-induced longshore currents.
- Turbidity currents.
- Rip currents.
- Tidal currents.
- Storm surge ebb currents.
- Gravity-driven currents.
- Wind-induced upwelling and downwelling.
- Wave-induced upwelling and downwelling.
- Gravity-induced downslope transport.



Figure 4-26. Gravel cusps at St. Joseph, MI, November, 1993. This is an example of a rhythmic bar and beach on a freshwater coast without tides but subject to irregular seiching

Additional complications are imposed by constantly changing shoreface conditions:

- The relative contributions made by the different transport mechanisms vary over time.
- Because of differing regional geological configuration and energy climate, the frequencies of occurrence of the different mechanisms vary with location.
- Oscillatory flows normally occur at many frequencies and are superimposed on mean flows and other oscillatory flows of long period.

(2) Middle Atlantic Bight experiments of Wright et al. (1991).

(a) Wright et al. (1991) measured suspended sediment movement, wave heights, and mean current flows at Duck, NC, in 1985 and 1987 and at Sandbridge, VA, in 1988 using instrumented tripods. During their study, which included both fair weather and moderate energy conditions, onshore mean flows (interpreted to be related to tides), were dominant over incident waves in generating

sediment fluxes. In contrast, during a storm, bottom conditions were strongly dominated by offshore-directed, wind-induced mean flows. Wright et al. attributed this offshore directed flow to a rise of 0.6 m in mean water level (during this particular storm) and a resultant strong seaward-directed downwelling flow.

(b) Wright et al. (1991) examined the mechanisms responsible for onshore and offshore sediment fluxes across the shoreface. They related two factors explicitly to incoming incident waves:

- Sediment diffusion arising from gradients in wave energy dissipation.
- Sediment advection caused by wave orbital asymmetries.

They found that four other processes may also play important roles in moving sediment:

- Interactions between groupy incident waves and forced long waves.
- Wind-induced upwelling and downwelling currents.

- Wave-current interactions.
- Turbidity currents.

Overall, Wright et al. found that incoming incident waves were of primary importance in bed agitation, while tide- and wind-induced currents were of primary importance in moving sediment. The incoming wave orbital energy was responsible for mobilizing the sand, but the unidirectional currents determined where the sand was going. Surprisingly, cross-shore sediment fluxes generated by mean flows were dominant or equal to sediment fluxes generated by incident waves in all cases and at all times.

(c) Based on the field measurements, Wright et al. (1991) concluded that “near-bottom mean flows play primary roles in transporting sand across isobaths on the upper shoreface” (p 49). It is possible that this dominance of mean flows is a feature which distinguished the Middle Atlantic Bight from other shorefaces. The oscillatory (wave) constituents may be proportionately much more important along coasts subject to persistent, high-energy swell, such as the U.S. west coast. Wright et al. also concluded that the directions, rates, and causes of cross-shore sediment flux varied temporally in ways that were only partly predictable with present theory.

f. Sea level change and the Bruun rule.

(1) General coastal response to changing sea level.¹ Many barrier islands around the United States have accreted vertically during the Holocene rise in global sea level, suggesting that in these areas the supply of sediment was sufficient to allow the beaches to keep pace with the rise of the sea. It is not clear how beaches respond to short-term variations in sea level. Examples of shorter processes include multi-year changes in Great Lakes water levels and multi-month sea level rises associated with the El Niño-Southern Oscillation in the Pacific.

(2) Storm response.

¹ Chapter 2 reviewed sea level change and outlined some of the associated coastal effects and management issues. Table 2-6 outlined how shoreline advance or retreat at any particular location is a balance between sediment supply and the rate of sea level change. In this section, sea level change is meant in a general sense to be caused by a combination of factors, including eustatic (global) changes and local effects due to vertical movements of the coastal land.

(a) Based on his pioneering research of southern California beaches in the 1940's, Shepard (1950) developed the classic model that there is an onshore-offshore exchange of sediment over winter-summer cycles. Studies since then have shown that this model applies mostly to beaches on swell-dominated coasts where the wave climate changes seasonally (particularly Pacific Ocean coasts) (Carter 1988). Many beaches do *not* show an obvious seasonal cycle. Instead, they erode during storms throughout the year and rebuild during subsequent fair weather periods.

(b) In some locations, such as the Gulf Coast, infrequent and irregular hurricanes may be the most important dynamic events affecting beaches. Following one of these storms, beach and dune rebuilding may take years (Figure 3-6 shows a portion of the Florida/Alabama shore that was damaged by Hurricane Frederick in 1979 and is slowly recovering). Recently, the popular belief that hurricanes are the most important morphodynamic events causing Gulf Coast beach erosion is being reevaluated with the benefit of new field data. Scientists have learned that, cumulatively, winter cold fronts produce significant annual barrier island retreat. Dinger, Reiss, and Plant (1993) monitored Louisiana's Isles Dernieres and found that Hurricane Gilbert (September 1988) produced substantial beach retreat initially, but it actually reduced the average erosion rate by modifying the slope of the shoreface from that produced by cold-front-generated storms. The different responses were related to the scale of the storms. Cold fronts, which individually were small storms, eroded the entire beach to the same degree. Most sand and mud was deposited offshore and only a small percentage of eroded sand was deposited on the backshore because the fronts usually did not raise the sea enough to cause overtopping. Hurricane Gilbert, in contrast, raised sea level substantially such that the primary erosion occurred on the upper beach, and much of the sand was deposited behind the island via overwash processes. Over a five-year period, the overall effect of this hurricane on the Isles Dernieres was to retard the retreat rate of the island by about 50 percent over that produced by cold fronts alone.

(3) Bruun Rule beach response model.

(a) One of the best-known shoreface response models was proposed by Bruun in 1962 (rederived in Bruun (1988)). Bruun's concept was that beaches adjust to the dominant wave conditions at the site. He reasoned that beaches had to respond in some manner because clearly they had adjusted and evolved historically as sea level had

changed. Beaches had not disappeared, they had moved. How was this translation accomplished? Earlier studies of summer/winter beach morphology provided clues that beaches responded even to seasonal changes in wave climate. The basic assumption behind Bruun's model is that with a rise in sea level, the equilibrium profile of the beach and the shallow offshore moves upward and landward. Bruun made several assumptions in his two-dimensional analysis:

- The upper beach erodes because of a landward translation of the profile.
- Sediment eroded from the upper beach is deposited immediately offshore; the eroded and deposited volumes are equal (i.e., longshore transport is not a factor).
- The rise in the seafloor offshore is equal to the rise in sea level. Thus, offshore the water depth stays constant.

(b) The Bruun Rule can be expressed as (Figure 4-27a):

$$R = \frac{L_*}{B + H_*} S \quad (4-5)$$

where

R = shoreline retreat

S = increase in sea level

L_* = cross-shore distance to the water depth H_*

B = berm height of the eroded area

Hands (1983) restated the Bruun Rule in simplified form:

$$x = \frac{zX}{Z} \quad (4-6)$$

where z is the change in water level. The ultimate retreat of the profile x can be calculated from the dimensions of the responding profile, X and Z , as shown in Figure 4-27b.

(c) Despite the continued interest in Bruun's concept, there has been only limited use of this method for

predictive purposes. Hands (1983) listed several possible reasons for the reluctance to apply this approach:

- Skepticism as to the adequacy of an equilibrium model for explaining short-term dynamic changes.
- Difficulties in measuring sediment lost from the active zone (alongshore, offshore to deep water, and onshore via overwash).
- Problems in establishing a realistic closure depth below which water level changes have no measurable effect on the elevation or slope of the seafloor.
- The perplexity caused by a discontinuity in the profile at the closure depth which appeared in the original and in most subsequent diagrams illustrating the concept.

An additional, and unavoidable, limitation of this sediment budget approach is that it does not address the question of *when* the predicted shore response will occur (Hands 1983). It merely reveals the horizontal distance the shoreline must *ultimately* move to reestablish the equilibrium profile at its new elevation under the assumptions stated in Bruun's Rule.

(d) Hands (1983) demonstrated the geometric validity of the Bruun Rule in a series of figures which show the translation of the profile upward and landward (the figures are two-dimensional; volumes must be based on unit lengths of the shoreline):

- Figure 4-28a: The equilibrium profile at the initial water level.
- Figure 4-28b: The first translation moves the active profile up an amount z and reestablishes equilibrium depths below the now elevated water level. Hands defines the *active profile* as the zone between the closure depth and the upper point of profile adjustment. The volume of sediment required to maintain the equilibrium water depth is proportional to X (width of the active zone) times z (change in water level).
- Figure 4-28c: The required volume of sediment is provided by the second translation, which is a recession (horizontal movement) of the profile by an amount x . The amount of sediment is proportional to x times Z , where Z is the vertical extent of the active profile from the closure depth to the average elevation of the highest erosion on the backshore.

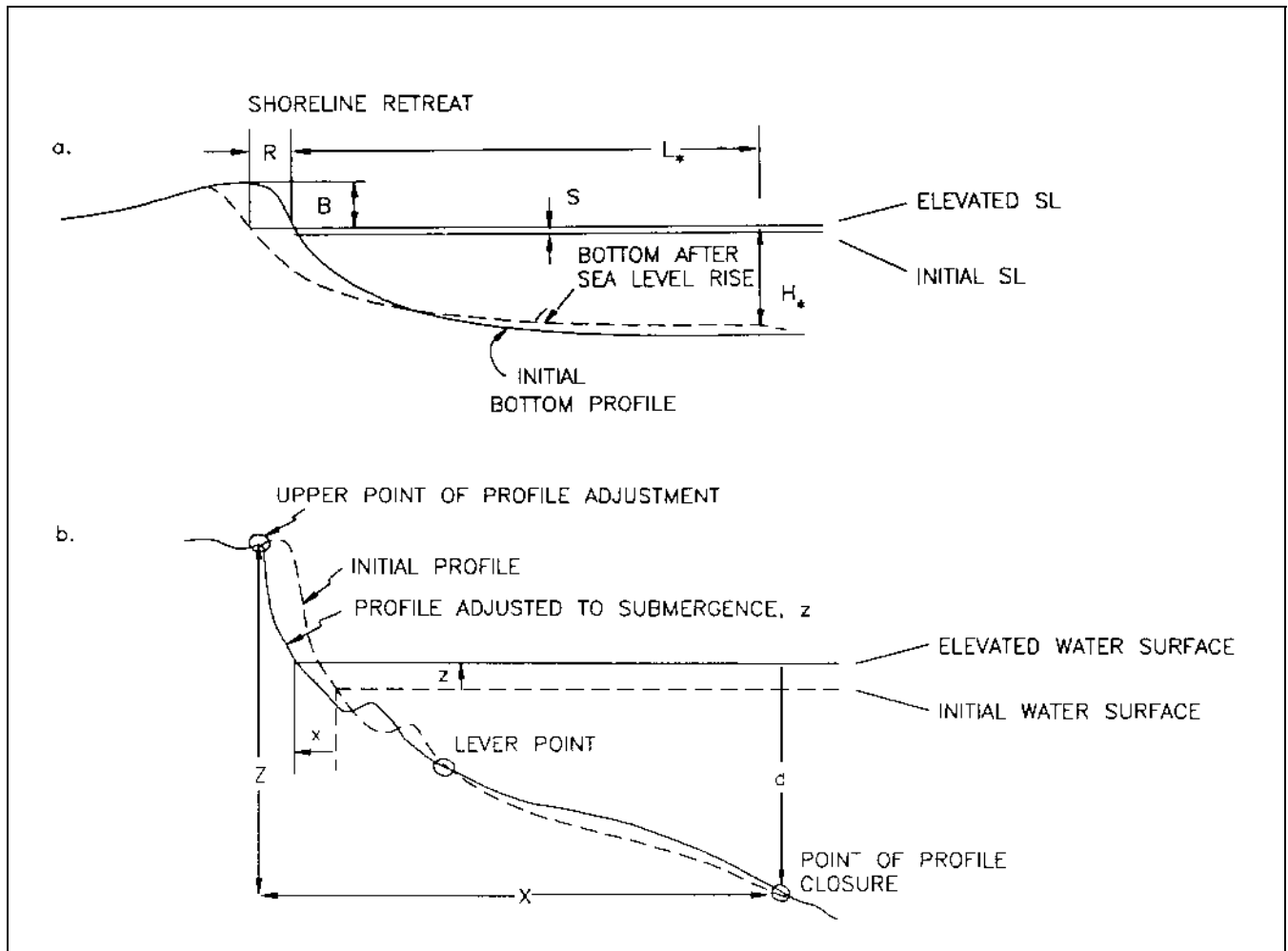

Figure 4-27. (a) Shoreline response to rising sea level (SL) depicted by the Bruun Rule. (b) Simplified nomenclature used by Hands (1983). The sandbar shows that the model is valid for complicated profile shapes

- Figure 4-28d: Equating the volume required by the vertical translation and the volume provided by the horizontal translation yields Equation 4-6. In reality, both translations occur simultaneously, causing the closure point to migrate upslope as the water level rises.

(e) One of the strengths of the Bruun concept is that the equations are valid regardless of the shape of the profile, for example, if bars are present (Figure 4-27b). It is important that an offshore distance and depth of closure be chosen that incorporate the entire zone where active sediment transport occurs. Thereby, sediment is conserved in spite of the complex processes of local erosion versus deposition as bars migrate (Komar et al. 1991). Another strength is that it is a simple relationship, a geometric conclusion based only on water level. Despite its simplicity and numerous assumptions, it works

remarkably well in many settings. Even with its shortcomings, it can be used to predict how beaches can respond to changes in sea level.

(4) Use of models to predict shoreline recession. Although field studies have confirmed the assumptions made by Bruun and others concerning translations of the shoreface, there has been no convincing demonstration that the models can predict shoreline recession rates. Komar et al. (1991) cite several reasons for the inability to use the models as predictive tools:

- Existence of a considerable time lag of the beach response following a sustained water level rise (as shown by Hands (1983) for Lake Michigan).
- Uncertainty in the selection of the parameters used in the equations (in particular, closure depth).

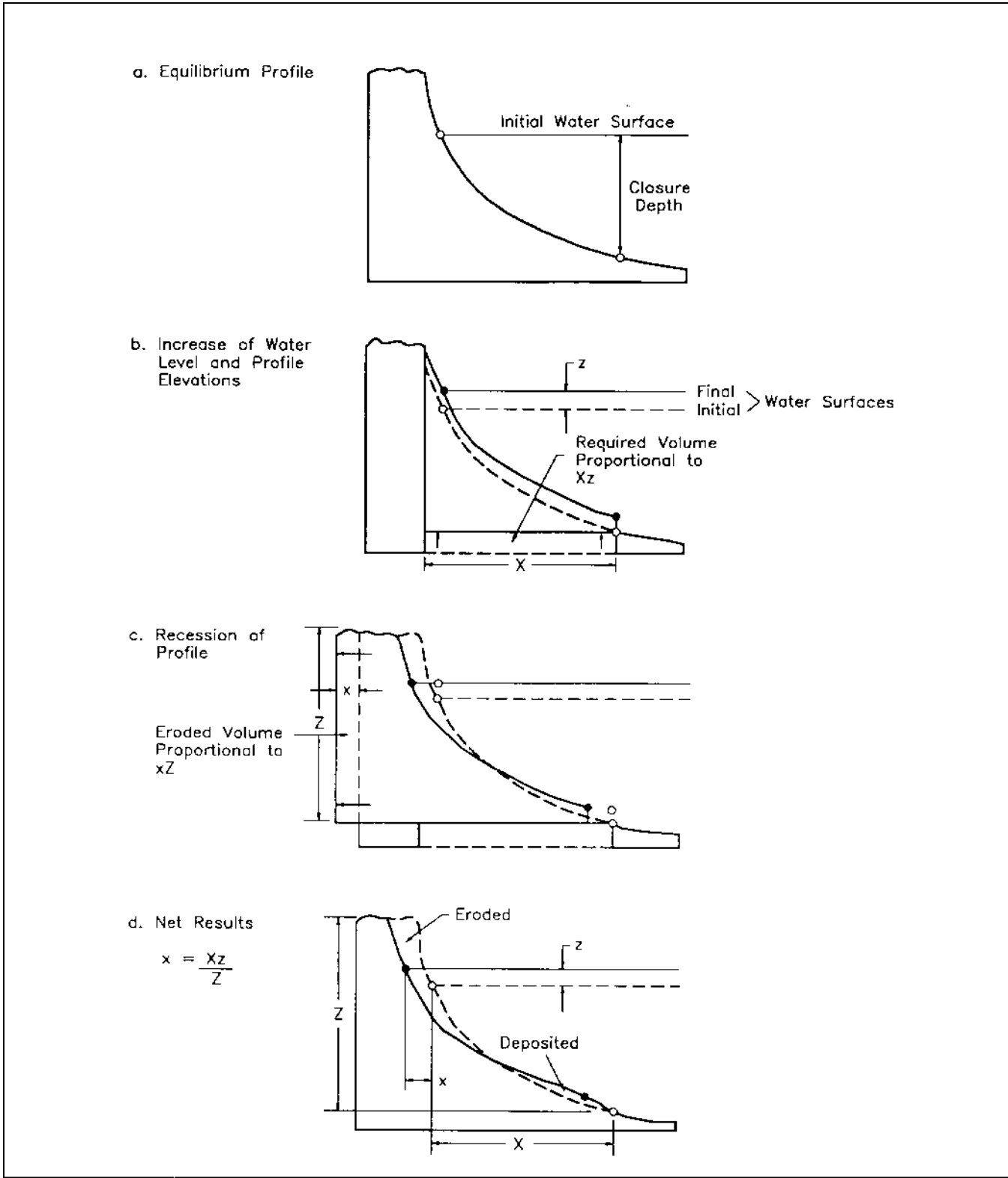

Figure 4-28. Profile adjustment in two stages, first vertical, then horizontal, demonstrating the basis for the Bruun Rule (Equation 4-6) (from Hands (1983)). Details are discussed in the text

- Local complexities of sediment budget considerations in the sand budget.

(5) Recommendations. We need more field and laboratory studies to better evaluate the response of beaches to rising (and falling) sea level. For example, it would be valuable to reoccupy the profile lines monitored by Hands (1976, 1979, 1980) in Lake Michigan in the 1970's to determine how the shores have responded to the high water of the mid-1980's and to the subsequent drop in the early 1990's. In addition, we need conceptual advances in the theoretical models. We also need to evaluate how sediment has moved onshore in some locations following sea level rise, because there is evidence that in some areas beach sand compositions reflect offshore rather than onshore sources (Komar et al. 1991).

g. Equilibrium profiles on sandy coasts.

(1) General characteristics and assumptions. The existence of an equilibrium shoreface profile (sometimes called equilibrium *beach* profile) is a basic assumption of many conceptual and numerical coastal models. Dean (1990) listed characteristic features of profiles:

- Profiles tend to be concave upwards.
- Fine sand is associated with mild slopes and coarse sand with steep slopes.
- The beach (above the surf zone) is approximately planar.
- Steep waves result in milder inshore slopes and a tendency for bar formation.

The main assumption underlying the concept of the shoreface equilibrium profile is that the seafloor is in equilibrium with *average* wave conditions. Presumably, the term *equilibrium* is meant to indicate a situation in which water level, waves, temperature, etc., are held constant for a sufficient time such that the beach profile arrives at a final, stable shape (Larson and Kraus 1989a). Larson (1991) described the profile as: "A beach of specific grain size, if exposed to constant forcing conditions, normally assumed to be short-period breaking waves, will develop a profile shape that displays no net change in time." This concept ignores the fact that, in addition to wave action, many other processes affect sediment transport. These simplifications, however, may represent the real strength of the concept because it has proven to be a useful way to characterize the shape of the shoreface in many locations around the world.

(2) Shape. Based on studies of beaches in many environments, Bruun (1954) and Dean (1976, 1977) have shown that many ocean beach profiles exhibit a concave shape such that the depth varies as the two-thirds power of distance offshore along the submerged portions:

$$h(x) = Ax^{2/3} \quad (4-7)$$

where

h = water depth at distance x from the shoreline

A = a scale parameter which depends mainly on sediment characteristics

This surprisingly simple expression asserts, in effect, that beach profile shape can be calculated from sediment characteristics (particle size or fall velocity) alone. Moore (1982) graphically related the parameter A , sometimes called the *profile shape parameter*, to the median grain size d_{50} . Hanson and Kraus (1989) approximated Moore's curve by a series of lines grouped as a function of the median nearshore grain size d_{50} (in mm):

$$\begin{aligned} A &= 0.41(d_{50})^{0.94} & , & \quad d_{50} < 0.4 \\ A &= 0.23(d_{50})^{0.32} & , & \quad 0.4 \leq d_{50} < 10.0 \\ A &= 0.23(d_{50})^{0.28} & , & \quad 10.0 \leq d_{50} < 40.0 \\ A &= 0.46(d_{50})^{0.11} & , & \quad 40.0 \leq d_{50} \end{aligned} \quad (4-8)$$

Dean (1987) related the parameter A to the sediment fall velocity w . On a log-log plot, the relationship was almost linear and could be expressed as:

$$A = 0.067 w^{0.44} \quad (4-9)$$

(3) Discussion of assumptions. Pilkey et al. (1993), in a detailed examination of the concept of the equilibrium shoreface profile, contended that several assumptions must hold true for the concept to be valid:

(a) *Assumption 1: All sediment movement is driven by incoming wave orbitals acting on a sandy shoreface.*

This assumption is incorrect because research by Wright et al. (1991) showed that sediment movement on the

shoreface is an exceedingly complex phenomenon, driven by a wide range of wave, tidal, and gravity currents. Even in locations where the wave orbitals are responsible for mobilizing the sand, bottom currents frequently determine where the sand will go.

(b) *Assumption 2: Existence of closure depth and no net cross-shore (i.e., shore-normal) transport of sediment to and from the shoreface.*

Pilkey et al. (1993) state that this assumption is also invalid because considerable field evidence has shown that large volumes of sand may frequently move beyond the closure depth. Such movement can occur during both fair weather and storm periods, although offshore-directed storm flows are most likely the prime transport agent. Pilkey et al. cite studies in the Gulf of Mexico which measured offshore bottom currents of up to 200 cm/sec and sediment transport to the edge of the continental shelf. The amount of sediment moved offshore was large, but it was spread over such a large area that the change in sea bed elevation could not be detected by standard profiling methods¹. Wright, Xu, and Madsen (1994) measured significant across-shelf benthic transport on the inner shelf of the Middle Atlantic Bight during the Halloween storm of 1991.

(c) *Assumption 3: There exists a sand-rich shoreface; the underlying and offshore geology must not play a part in determining the shape of the profile.*

Possibly the most important of the assumptions implicit in the equilibrium profile concept is that the entire profile is sand-rich, without excessive areas of hard bottom or mud within the active profile. Clearly these conditions do not apply in many parts of the world. Coasts that have limited sand supplies, such as much of the U.S. Atlantic margin, are significantly influenced by the geologic framework occurring underneath and in front of the shoreface. Many of the east coast barriers are perched on a platform of ancient sediment. Depending upon the physical state, this underlying platform can act as a subaqueous headland or hardground that dictates the shape of the shoreface profile and controls beach dynamics and the composition of the sediment.

¹ This latter statement underscores how important it is to develop improved methods to detect and measure sediment movement in deep water. With the present state of the science, the inability to measure changes in offshore sea bed elevation neither proves nor disproves the assumption of no significant sediment movement beyond the depth of closure.

Niederoda, Swift, and Hopkins (1985) believed that the seaward-thinning and fining veneer of modern shoreface sediments is ephemeral and is easily removed from the shoreface during major storms. During storms, Holocene and Pleistocene strata cropping out on the shoreface provide the immediate source of the bulk of barrier sands. Swift (1976) used the term *shoreface bypassing* to describe the process of older units supplying sediment to the shoreface of barrier islands.

Pilkey et al. (1993) contend that:

...a detailed survey of the world's shorefaces would show that the sand rich shoreface required by the equilibrium profile model is an exception rather than the rule. Instead, most shorefaces are underlain by older, consolidated or semi-consolidated units covered by only a relatively thin veneer of modern shoreface sands. These older units are a primary control on the shape of the shoreface profile. The profile shape is not determined by simple wave interaction with the relatively thin sand cover. Rather, the shape of the shoreface in these sediment poor areas is determined by a complex interaction between underlying geology, modern sand cover, and highly variable (and often highly diffracted and refracted) incoming wave climate. (p. 271)

(d) *Assumption 4: If a shoreface is, in fact, sand-rich, the smoothed profile described by the equilibrium profile equation (ignoring bars and troughs) must provide a useful approximation of the real shoreface shape.*

In addressing this assumption, Pilkey et al. (1993) cited studies conducted on the Gold Coast, in Queensland, Australia. The Gold Coast shoreface is sand-rich to well beyond a depth of 30 m. Without being directly influenced by underlying geology, the shoreface is highly dynamic. As a consequence, the Gold Coast shoreface shape cannot be described by one equilibrium profile; rather, it is best described by an ever-changing regime profile. Pilkey et al. concluded:

The local shoreface profile shapes are entirely controlled by relative wave energy "thresholds"; for the sediment properties have not changed at all. Thus principal changes to the shoreface profiles of the Gold Coast are driven by wave power history with some modification by currents, and not by sediment size, or its parameter A, as defined within the equilibrium profile concept. (p. 272).

(4) General comments.

(a) The idea of a profile only adjusting to waves is fundamentally wrong as shown by Wright et al. (1991) and others. However, although the physical basis for the equilibrium profile concept is weak, critics of this approach have not proven that it always results in highly erroneous answers.

(b) Before the use of the equilibrium profile, coastal engineers had no way to predict beach change other than using crude approximations (e.g., sand loss of 1 cu yd/ft of beach retreat). The approximations were inadequate. Surveys from around the world have shown that shoreface profiles display a characteristic shape that differs with locality but is relatively stable for a particular place (i.e., Duck, NC). With many caveats (which are usually stated, then ignored), a profile can be reasonably represented by the equilibrium equation. The fit between the profile and the real seafloor on a daily, seasonal, and storm variation basis may not be perfect, but the differences may not matter in the long term.

(c) One critical problem for coastal engineers is to predict what a sequence of waves (storm) will do to a locality when little is known about the particular shape of the pre-storm beach. For this reason, numerical models like SBEACH (Larson and Kraus 1989), despite their reliance on the equilibrium profile concept, are still useful. The models allow a researcher to explore storm impact on a location using a general approximation of the beach. The method is very crude - however, the resulting numbers are of the right order of magnitude when compared with field data from many locations.

(d) Answers from the present models are not exact, and researchers still have much to learn about the weakness of the models and about physical processes responsible for the changes. Nevertheless, the models do work and they do provide numbers that are of the correct magnitudes when run by careful operators. Users of shoreface models must be aware of the limitations of the models and of special conditions that may exist at their project sites. In particular, profile-based numerical models are likely to be inadequate in locations where processes other than wave-orbital transport predominate.

h. Depth of closure.

(1) Background.

(a) *Depth of closure* is a concept that is often misinterpreted and misused. For engineering practice, depth of

closure is commonly defined as the minimum water depth at which no measurable or significant change in bottom depth occurs (Stauble et al. 1993). The word *significant* in this definition is important because it leaves considerable room for interpretation. "Closure" has erroneously been interpreted to mean the depth at which no sediment moves on- or offshore, although numerous field studies have verified that much sediment moves in deep water (Wright et al. 1991). Another complication is introduced by the fact that it is impossible to define a single depth of closure for a project site because "closure" moves depending on waves and other hydrodynamic forces.

(b) For the Atlantic Coast of the United States, closure depth is often assumed to be about 9 m (30 ft) for use in engineering project design. However, at the Field Research Facility (FRF) in Duck, NC, Birkemeier (1985) calculated closure as deep as 6.3 m relative to mlw using CRAB surveys. Stauble et al. (1993) obtained 5.5 to 7.6 m at Ocean City, MD, from profile surveys. Obviously, it is invalid to assume that "closure" is a single fixed depth along the eastern United States.

(c) Closure depth is used in a number of applications such as the placement of mounds of dredged material, beach fill, placement of ocean outfalls, and the calculation of sediment budgets.

(2) Energy factors. As discussed above, the primary assumption behind the concept of the shoreface equilibrium profile is that sediment movement and the resultant changes in bottom elevation are a function of wave properties and sediment grain size. Therefore, the active portion of the shoreface varies in width throughout the year depending on wave conditions. In effect, "closure" is a time-dependent quantity that may be predicted based on wave climatology or may be interpreted statistically using profile surveys.

(3) Time considerations. The energy-dependent nature of the active portion of the shoreface also requires us to consider return period. The closure depth that accommodates the 100-year storm will be much deeper than one that merely needs to include the 10-year storm. Therefore, the choice of a closure depth must be made in light of a project's engineering requirements and design life. For example, if a berm is to be built in deep water where it will be immune from wave resuspension, what is the minimum depth at which it should be placed? This is an important question because of the high costs of transporting material and disposing of it at sea. It would be tempting to use a safe criteria such as the 100- or 500-year storm, but excessive costs may force the project

engineer to consider a shallower site that may be stable only for shorter return period events.

(4) Predictive methods.

(a) Hallermeier (1977, 1978, 1981a, 1981b, 1981c), using laboratory tests and limited field data, introduced equations to predict the limits of extreme wave-related sediment movement. He calculated two limits, d_e and d_i , that included a buffer region on the shoreface called the shoal zone. Landward of d_e , significant alongshore transport and intense onshore-offshore sediment transport occur (the littoral zone). Within the shoal zone, expected waves have neither a strong nor a negligible effect on the sandy bed during a typical annual cycle of wave action. Seaward of d_i , only insignificant onshore-offshore transport by waves occurs. The deeper limit was based on the median nearshore storm wave height (and the associated wave period). The boundary between the shoal zone and the littoral zone (d_e) as defined represents the annual depth of closure. Hallermeier (1978) suggested an analytical approximation, using linear wave theory for shoaling waves, to predict an *annual* value of d_e :

$$d_e = 2.28H_e - 68.5 \left(\frac{H_e^2}{gT_e^2} \right) \quad (4-10)$$

where

d_e = annual depth of closure below mean low water

H_e = the non-breaking significant wave height that is exceeded 12 hr per year (0.137% of the time)

T_e = the associated wave period

g = acceleration due to gravity

According to Equation 4-10, d_e is primarily dependent on wave height with an adjustment for wave steepness. Hallermeier (1978) proposed using the 12-hr exceeded wave height, which allowed sufficient duration for “moderate adjustment towards profile equilibrium.” Equation 4-10 is based on quartz sand with submerged density of $\gamma' = 1.6$ and median diameter between 0.16 and 0.42 mm, which typifies conditions in the nearshore for many beaches. If the grain size is larger than 0.42 mm, Equation 4-10 may not be appropriate. Because d_e was derived from linear wave theory for shoaling waves, d_e must be seaward of the influence of intense wave-induced

nearshore circulation. However, because of various factors, Hallermeier (1978) “proposed that the calculated d_e be used as a minimum estimate of profile close-out depth with respect to low(er) tide level.” Because tidal or wind-induced currents may increase wave-induced near-bed flow velocities, Hallermeier suggested using mean low water (mlw) as a reference water level to obtain a conservative depth of closure. Note that Hallermeier’s equations critically depend on the quality of wave data at a site. The reader is cautioned that Hallermeier’s equations can be expressed in various forms depending on the assumptions made, the datums used as reference levels, and available wave data. The reader is referred to his original papers for clarification and for details of his assumptions. The equations may not be applicable at sites where currents are more important at moving sand than wave-induced flows.

(b) At the Lake Michigan sites that Hands (1983) surveyed, the closure depth was equal to about twice the height of the 5-year return period wave height (H_5):

$$Z \approx 2H_5 \quad (4-11)$$

In the absence of strong empirical evidence as to the correct closure depth, this relationship is recommended as a rule of thumb to estimate the 5-year profile response under Great Lakes conditions. The return period of the wave height should approximate the design life of interest. For example, the 20-year closure depth would be estimated by doubling the 20-year return period wave height ($Z \approx 2H_{20}$).

(5) Empirical determination.

(a) When surveys covering several years are available for a project site, closure is best determined by plotting and analyzing the profiles. The closure depth computed in this manner reflects the influence of storms as well as of calmer conditions. Kraus and Harikai (1983) evaluated the depth of closure as the minimum depth where the standard deviation in depth change decreased markedly to a near-constant value. Using this procedure, they interpreted the landward region where the standard deviation increased to be the active profile where the seafloor was influenced by gravity waves and storm-driven water level changes. The offshore region of smaller and nearly constant standard deviation was primarily influenced by lower frequency sediment-transporting processes such as shelf and oceanic currents (Stauble et al. 1993). It must be noted that the smaller standard deviation values fall within the limit of measurement

accuracy. This suggests that it is not possible to specify a closure depth unambiguously because of operational limits of present offshore profiling hardware and procedures.

(b) An example of how closure was determined empirically at Ocean City, MD, is shown in Figure 4-29 (from Stauble et al. (1993)). A clear reduction in standard deviation occurs at a depth of about 18 to 20 ft. Above the ~18-ft depth, the profile exhibits large variability, indicating active wave erosion, deposition, and littoral transport. Deeper (and seaward) of this zone, the lower and relatively constant deviation of about 3 to 4 inches is within the measurement error of the sled surveys. Nevertheless, despite the inability to precisely measure seafloor changes in this offshore region, it is apparent that less energetic erosion and sedimentation take place here than in water shallower than ~18 ft. This does not mean that there is no sediment transport in deep water, just that the sled surveys are unable to measure it. For the 5.6 km of shore surveyed at Ocean City, the depth of closure ranged between 18 and 25 ft. Scatter plots indicated that the average closure depth was 20 ft.

(c) Presumably, conducting surveys over a longer time span at Ocean City would reveal seafloor changes deeper than ~20 ft, depending on storms that passed the region. However, Stauble et al. (1993) noted that the "Halloween Storm" of October 29 to November 2, 1991, generated waves of peak period (T_p) 19.7 sec, extraordinarily long compared to normal conditions along the central Atlantic coast. Therefore, the profiles may already reflect the effects of an unusually severe storm.

(d) Figure 4-30 is an example of profiles from St. Joseph, MI, on the east shore of Lake Michigan. Along Line 14, dramatic bar movement occurs as far as 2,500 ft offshore to a depth of -25 ft with respect to International Great Lakes Datum (IGLD) 1985. This is where an abrupt decrease in standard deviation of lake floor elevation occurs and can be interpreted as closure depth. In September 1992, the mean water surface was 1.66 ft above IGLD 85. Therefore, closure was around 26-27 ft below *water* level.

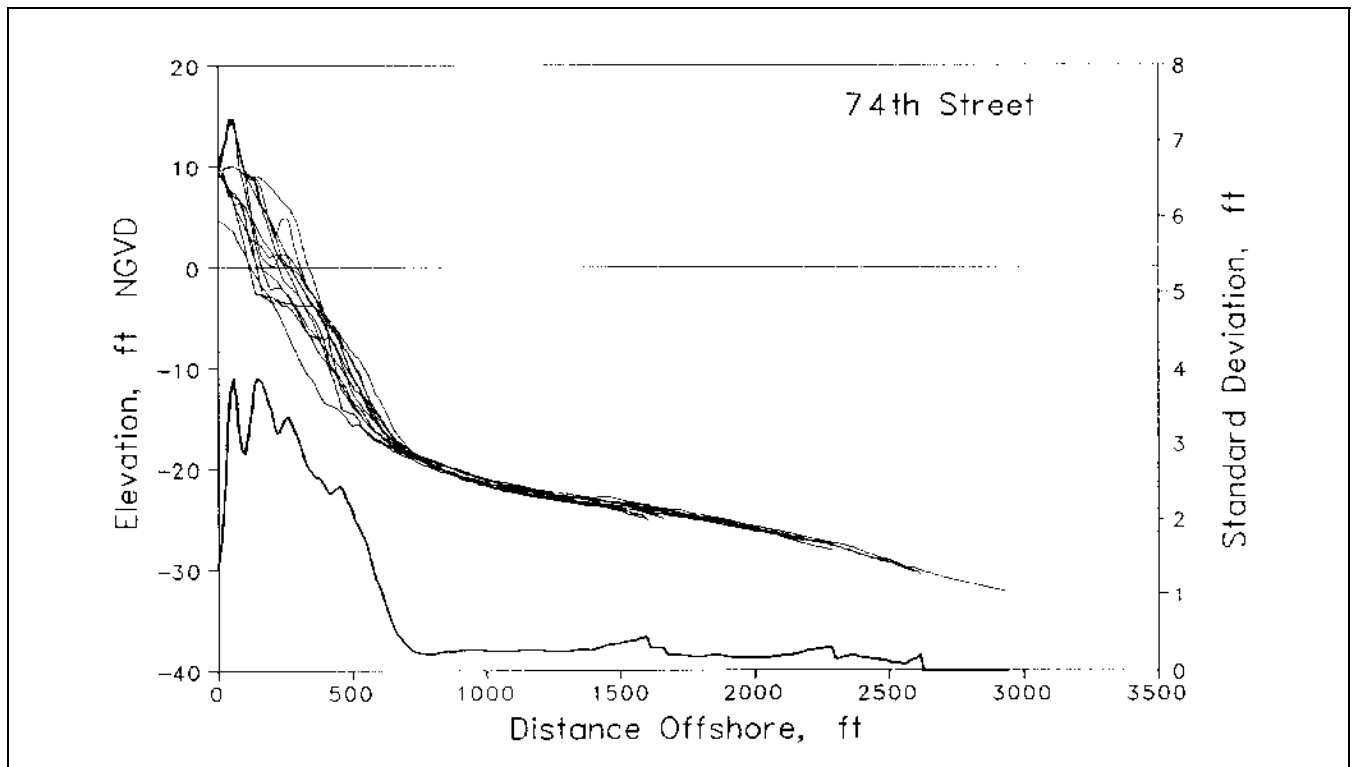

Figure 4-29. Profile surveys and standard deviation of seafloor elevation at 74th Street, Ocean City, MD (from Stauble et al. (1993)). Surveys conducted from 1988 to 1992. Large changes above the datum were caused by beach fill placement and storm erosion. Figure discussed in the text

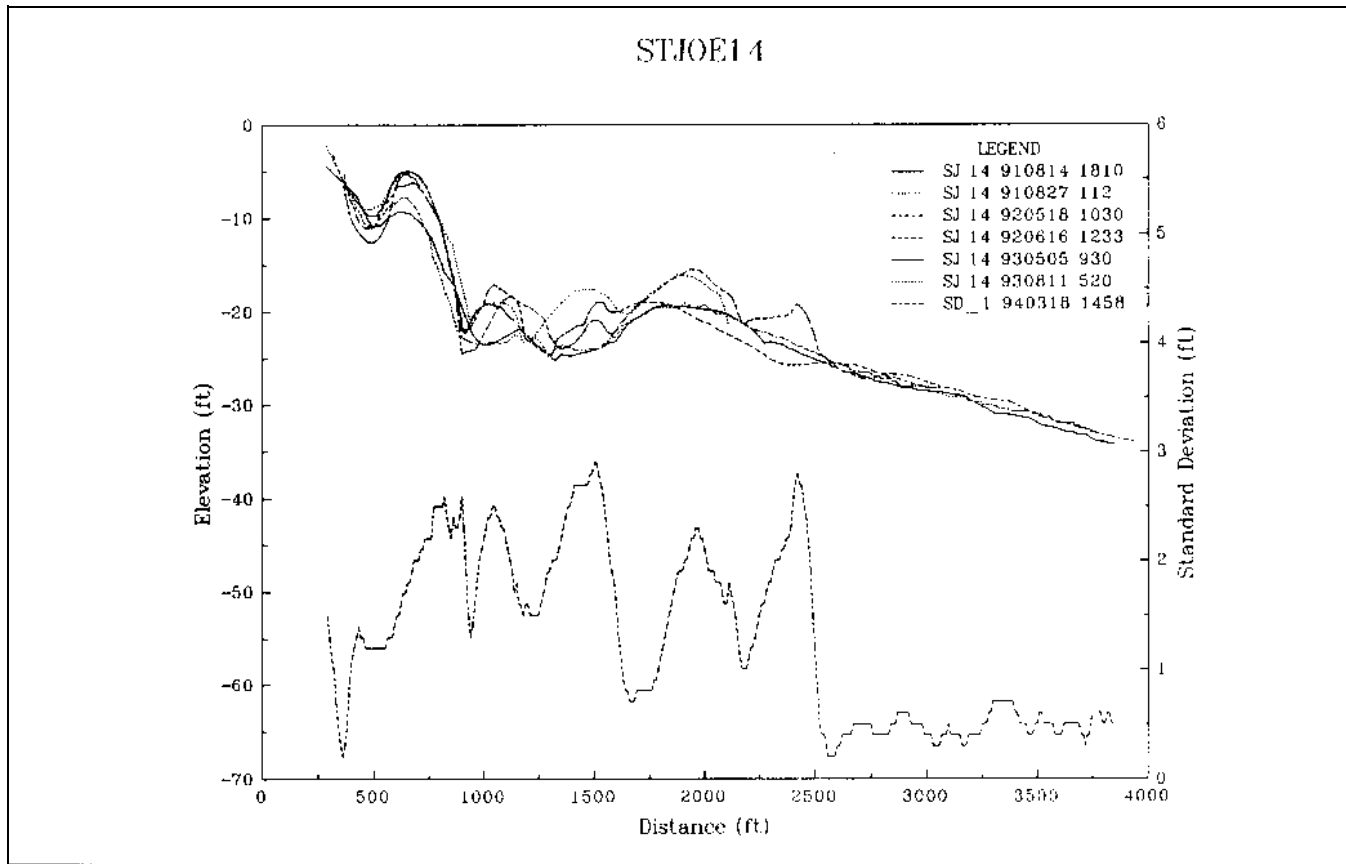

Figure 4-30. Profile surveys and standard deviation of lake floor elevation at St. Joseph, MI, on the east shore of Lake Michigan. Profiles are referenced to International Great Lakes Datum (IGLD) 1985. Surveys conducted between 1991 and 1994 (previously unpublished CERC data). Figure discussed in the text

(e) In the Great Lakes, water levels fluctuate over multi-year cycles. This raises some fundamental difficulties in calculating closure based on profile surveys. Presumably, during a period of high lake level, the zone of active sand movement would be higher on the shoreface than during a time of low lake level (this assumes similar wave conditions). Therefore, the depth where superimposed profiles converge should reflect the *deepest* limit of active shoreface sand movement. This would be a conservative value, but *only with respect to the hydrologic conditions that occurred during the survey program*. Presumably, if lake level dropped further at a later date, sediment movement might occur deeper on the shoreface. This suggests that closure on the lakes should be chosen to reflect the *lowest* likely water level that is expected to occur during the life of a project. (Note that this consideration does not arise on ocean coasts because year-to-year changes in relative sea level are minor, well within the error bounds of sled surveys. Sea level does change throughout the year because of thermal expansion,

fresh-water runoff, and other factors as discussed in Chapter 2, but the multi-year mean is essentially stable.) In summary, determining closure depth in the Great Lakes is problematic because of changing water levels, and more research is needed to develop procedures that accommodate these non-periodic lake level fluctuations.

i. Longshore sediment movement.

The reader is referred to *Coastal Sediment Transport* (EM 1110-2-1502) for a detailed treatment of longshore transport.

j. Summary.

(1) A model of shoreface morphodynamics for micro- and low-mesotidal sandy coasts has been developed by Wright and Short (1984). The six stages of the model (Figure 4-22), illustrate the response of sandy beaches to various wave conditions.

(2) Sediment movement on the shoreface is a very complicated phenomenon. It is a result of numerous hydrodynamic processes, including: (1) wave orbital interactions with bottom sediments and with wave-induced longshore currents; (2) wind-induced longshore currents; (3) rip currents; (4) tidal currents; (5) storm surge ebb currents; (6) gravity-driven currents; (7) wind-induced upwelling and downwelling; (8) wave-induced upwelling and downwelling; and (9) gravity-induced downslope transport.

(3) The Bruun Rule (Equation 4-5 or 4-6) is a model of shoreface response to rising sea level. Despite the model's simplicity, it helps explain how barriers have accommodated rising sea level by translating upward and landward. A limitation is that the model does not address *when* the predicted shore response will occur (Hands 1983). It merely reveals the horizontal distance the shoreline must *ultimately* move to reestablish the equilibrium profile at its new elevation under the stated assumptions.

(4) The concept of the equilibrium shoreface profile applies to sandy coasts primarily shaped by wave action. It can be expressed by a simple equation (Equation 4-7) which depends only on sediment characteristics. Although the physical basis for the equilibrium profile concept is weak, it is a powerful tool because models based on the concept produce resulting numbers that are of the right order of magnitude when compared with field data from many locations.

(5) *Closure* is a concept that is often misinterpreted and misused. For engineering practice, depth of closure is commonly defined as the minimum water depth at which no measurable or significant change in bottom depth occurs (Stauble et al. 1993). Closure can be computed by two methods: (1) analytical approximations such as those developed by Hallermeier (1978) which are based on wave statistics at a project site (Equation 4-10); or (2) empirical methods based on profile data. When profiles are superimposed, a minimum value for closure can be interpreted as the depth where the standard deviation in depth change decreases markedly to a near-constant value. Both methods have weaknesses. Hallermeier's analytical equations depend on the quality of wave data. Empirical determinations depend on the availability of several years of profile data at a site. Determining closure in the Great Lakes is problematic because lake levels fluctuate due to changing hydrographic conditions.

4-6. Cohesive Shore Processes and Dynamics

a. Introduction.

(1) Cohesive sediments are typically homogenous mixtures of fine sand, silt, clay, and organic matter that have undergone consolidation during burial. These mixtures derive their strength from the cohesive (electrochemical attractive) properties of clay minerals, most commonly kaolinite, illite, chlorite, and montmorillonite. Clay particles exhibit a layered structure forming flaky, plate-like crystals that carry negative charges around their edges causing cations to be absorbed onto the particle surface. The presence of free cations is critical to the bonding of clay platelets. As clay particles become smaller, perimeters of the crystals become proportionally greater, which acts to increase the charge of each particle (Owen 1977). Owen (1977) describes a process in which some clays have the ability to absorb ions from solution into the layered structure of the clay, which allows the clay crystal to adjust its size and surface charge. In general, the higher the proportion of clay minerals, the more cohesive the sediment, although the type of clay mineral present, particle size, and the quantity and type of cations present in solution are also important factors.

(2) The presence of organic material may also be responsible for the cohesion of fine-grained sediments. Various organic substances are electrically charged and capable of acting as nuclei to attract clay minerals, forming particles having a clay-organic-clay structure (Owen 1977). Mucous secretions from various organisms can also bond fine particles together, forming cohesive sediments. These organic cohesive processes are quite common in low energy estuarine environments where fine-grained sediment sources are abundant and biological productivity is high.

(3) Detailed information on clay mineralogy and behavior is found in geotechnical engineering texts (Bowles 1979, 1986; Spangler and Hardy 1982).

(4) Hard, desiccated (dry), and well-compacted cohesive sediments are generally more erosion-resistant than cohesionless sediments exposed to the same physical conditions. Glacial till in some areas, such as the shores of the Great Lakes, is as consolidated and dense as sedimentary rock. Compacted and desiccated clay which is exposed on the seafloor in some formerly glaciated coasts (for example, off New England and Tierra del Fuego,

Argentina), is rock-hard and very difficult to penetrate with drilling equipment.

(5) In contrast, recent clayey sediments in river deltas or estuaries have a high water content and are readily resuspended by waves. As long as the receiving basins remain protected and there is a steady supply of new sediment, the soft clays accumulate and slowly compact (over thousands of years). Major storms like hurricanes can produce dramatic changes to marshy shores, especially if protective barrier islands are breached or overtopped by storm surges. A marshy coastline may also be severely eroded by normal (non-storm) waves if a river has changed its route to a different distributory channel, cutting off the sediment supply to this portion of the coast. The migration of the Mississippi River mouths is one of the factors contributing to coastal erosion in southern Louisiana (discussed in more detail in Chapter 4, Section 2).

(6) Coastal dynamic processes of cohesive shores are not as well understood and have not been as thoroughly studied as the dynamics of sandy shores. Because cohesive materials are very fine-grained, they are usually not found in recent deposits in exposed, high-energy coastlines. However, outcrops of ancient clay sediments may be present and may be surprisingly resistant to wave action. In protected environments where clays do accumulate, the shores develop distinctive morphological features in comparison with unconsolidated shorelines. Nairn (1992) defines a high-energy cohesive shore as being composed largely of a cohesive sediment substratum that plays a dominant role in the change of shoreline shape through the process of erosion. On the other hand, estuaries and tidal rivers are governed by quite different conditions: cohesive sediments are eroded, transported, and deposited on the seafloor primarily by tidal or fluvial currents (Owen 1977). This type of environment is also characterized by extremely high concentrations of suspended material in the nearshore water.

(7) The processes described here consider two categories of cohesive environments. The first deals with high-energy, erosional shorelines consisting of relict cohesive material being acted upon by contemporary processes. Materials from these environments are characterized by erosion-resistant, consolidated cohesive sediments that form distinctive geomorphic features along open shorelines. In contrast, the second category deals with low-energy, depositional environments of soft, unconsolidated muds, silts, and clays, characteristic of estuaries, deltas, and marshes.

b. High-energy cohesive coasts.

(1) High-energy cohesive coasts are those that do not permit abundant accumulation of fine-grained material due to sustained wave attack. Cohesive sediments in these environments are products of ancient geologic events that deposited and compacted the material into its present state. Coastal processes have exposed the material, leaving it vulnerable to the contemporary, high-energy wave conditions. The result is usually irreversible erosion across the entire active profile from the backshore bluff face to distances well offshore. These conditions are frequently found on open ocean shorelines in California and Massachusetts and are very common in the Great Lakes.

(2) Exposed cohesive coastlines have the ability to resist erosion due to the compressive, tensile, and consolidated properties exhibited by the sediment. Because these shores are primarily erosional rather than depositional, they exhibit distinctive morphological features in comparison with cohesionless shores. These distinct characteristics include steep vertical bluffs that constitute a marked discontinuity in slope between the upland and the shore (Mossa, Meisberger, and Morang 1992).

(3) The presence of a cohesive material underlying an unconsolidated sandy beach controls how the shoreface erodes. If the cohesive material is eroded by the high energy processes typical along open ocean and Great Lakes shorelines, the cohesive properties are lost. The fine-grained material does not have the ability to reconstitute itself, resulting in irreversible erosion. Most beach sand that results is quickly swept away during storms, preventing the formation of protective beaches. Where sand can accumulate, it has an important interactive role in cohesive shore processes. Sunamura (1976) states that sand introduced to the system acts as an abrasive agent on cohesive material, thereby increasing erosion rates. Nairn (1992) and Kamphius (1987, 1990) have shown that downcutting of the nearshore cohesive substratum by abrasion is the controlling factor in the recession of adjacent bluffs in the Great Lakes. The downcutting and deepening of the nearshore profile allows higher waves to attack the foreshore, resulting in accelerated bluff recession, as illustrated in Figure 4-31. However, as sand thickness increases over the cohesive surface, a threshold is reached where the sand protects the underlying material. At this stage, downcutting no longer occurs and shore recession is arrested.

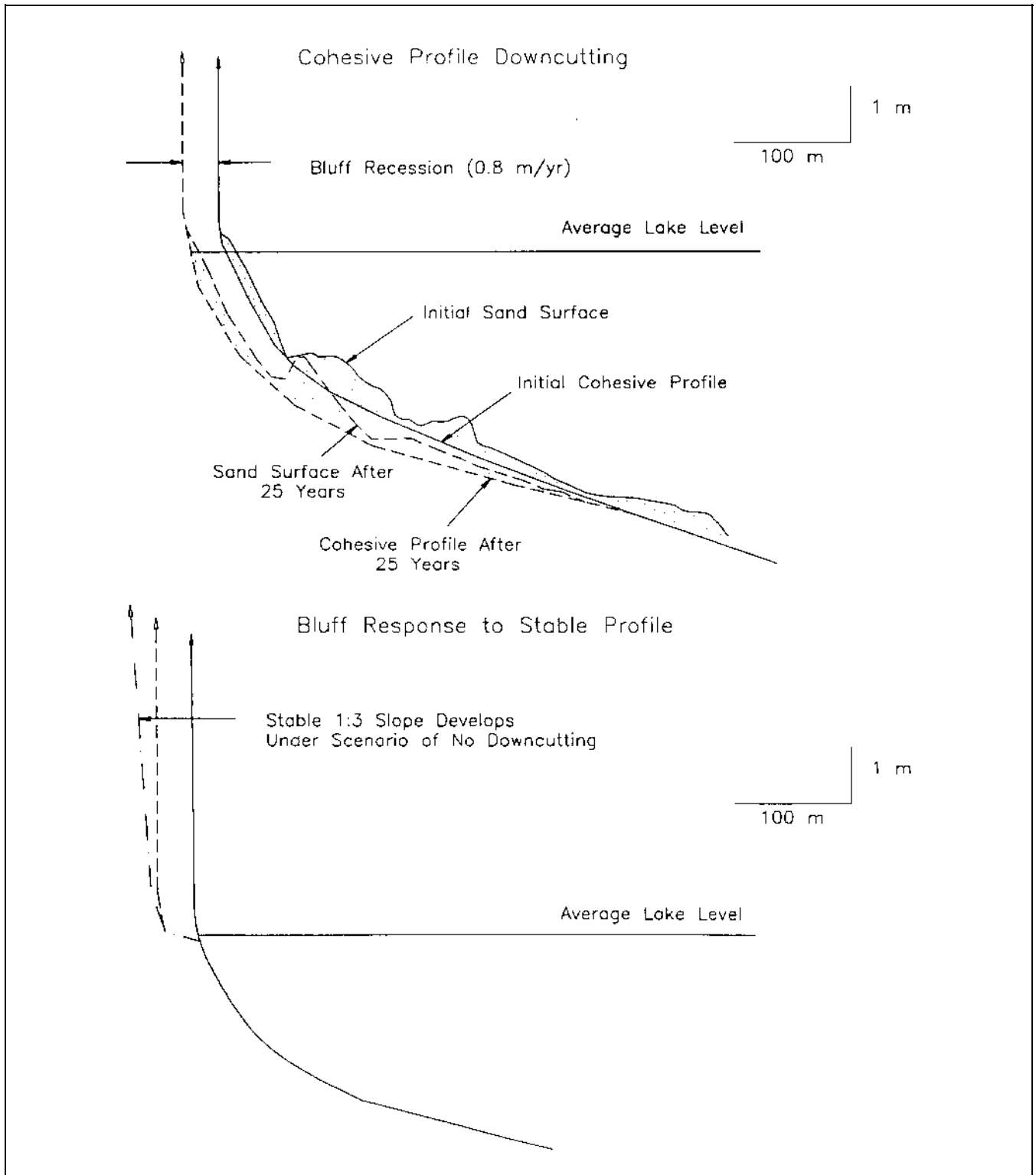

Figure 4-31. Illustration showing the relationship between downcutting of cohesive material in the nearshore and bluff recession (from Nairn (1992))

(4) Slopes and recession rates of the bluff faces depend on energy conditions as well as the geotechnical properties of the bluffs (grain size and degree of consolidation). Coastal processes, primarily waves, erode and undercut the base of the bluffs. This causes the upper portions to slump, resulting in a wide range of slope angles. In time, the bluffs may be fronted by a gently sloping beach or intertidal platform where debris may accumulate (Figure 3-22 and 4-32). If waves and currents remove the erosional debris faster than the rate of supply, then the bluff will rapidly retreat, resulting in a steep slope face. When the supply of eroded material exceeds the removal rate, debris accumulates at the base of the bluff, allowing for a lower angle slope face. Coasts shaped by these processes exhibit irregular shorelines. The formation of headlands and bays may be related to differential erosion rates of the various cohesive materials that are present. Once formed, irregular topography may have pronounced influence on waves, tides, sediment transport, and further shoreline evolution.

(5) Shorelines of the Great Lakes illustrate the processes described above. Cohesive shores on the Great Lakes are typically composed of hard glacial till deposits, remnants from the glacial processes that formed the lakes. Characteristic of Great Lakes cohesive shorelines is the existence of a backshore bluff (Figure 4-33). The bluff can be as low as a half meter, in the form of a wave cut terrace, or may be as high as 60 m or more (Nairn 1992). Where recession of the bluff has occurred, the face is steep and lacks vegetation. In some instances, there may be sandy beaches just seaward of the base of the bluff and there may be offshore sandbars. Other characteristics include the presence of exposed cohesive outcrops in the nearshore. Where sand cover is thin, intermittent, or non-existent, downcutting of the nearshore lake bed occurs, leaving the base of the bluffs vulnerable to wave attack, allowing accelerated shoreline retreat.

(6) Much of Alaska's Bering Sea, Beaufort Sea, and Chukchi Sea coasts have low bluffs of permanently frozen glacial till. The water content of the till varies, and the bluffs thaw at varying rates on exposure to air during the summer. Storm surges cause dramatic bluff failures as ice in the toe turns to liquid and shear failures allow still-frozen blocks of bluff to fall. At times, these shores are protected by shore-fast ice that rides up at or near the summer water time, creating "ramparts" that may be several meters high. Some mechanical scour occurs, but often the net effect is armoring because the ramparts last beyond the time when the offshore ice is gone.

c. Estuaries and low-energy, open-shore coasts.

(1) Estuaries are semi-enclosed, protected, bodies of water where ocean tides and fresh water are exchanged. They function as sinks for enormous volumes of sediment. Estuarine sediments are derived from various sources including rivers, the continental shelf, local erosion, and biological activity, and sedimentation is controlled by tides, river flow, waves, and meteorology. The lower-energy conditions of estuaries, as opposed to those found on open coasts, allow for the deposition of fine-grained silts, muds, clays, and biogenic materials. Estuarine sediments are typically soft and tend to be deposited on smooth surfaces that limit turbulence of the moving water. When allowed to accumulate, these materials consolidate and undergo various chemical and organic changes, eventually forming cohesive sediments.

(2) The shores of estuaries and certain open-water coasts in low-energy environments (e.g., coastal Louisiana, Surinam, Bangladesh, and Indonesia) are characterized as having smooth, low-sloping profiles with turbid water occurring along the shore and extending well offshore (Suhayda 1984). These areas usually exhibit low and vegetated backshores and mud flats which are exposed at low tide. These conditions are also found in Chesapeake and Delaware Bays.

(3) Nichols and Biggs (1985) describe the movement of estuarine sediments as consisting of four processes:

- Erosion of bed material.
- Transportation.
- Deposition on the bed.
- Consolidation of deposited sediment.

These processes are strongly dependent on estuarine flow dynamics and sediment particle properties. The properties most important for cohesive sediments are interparticle bonding and chemical behavior because these parameters make cohesive sediment respond quite differently to hydrodynamic forces than to noncohesive sediments. Due to the cohesive bonding, consolidated materials (clays and silts) require higher forces to mobilize, making them more resistant to erosion. However, once the cohesive sediment is eroded, the fine-grained clays and silts can be transported at much lower velocity than is required for the initiation of erosion.

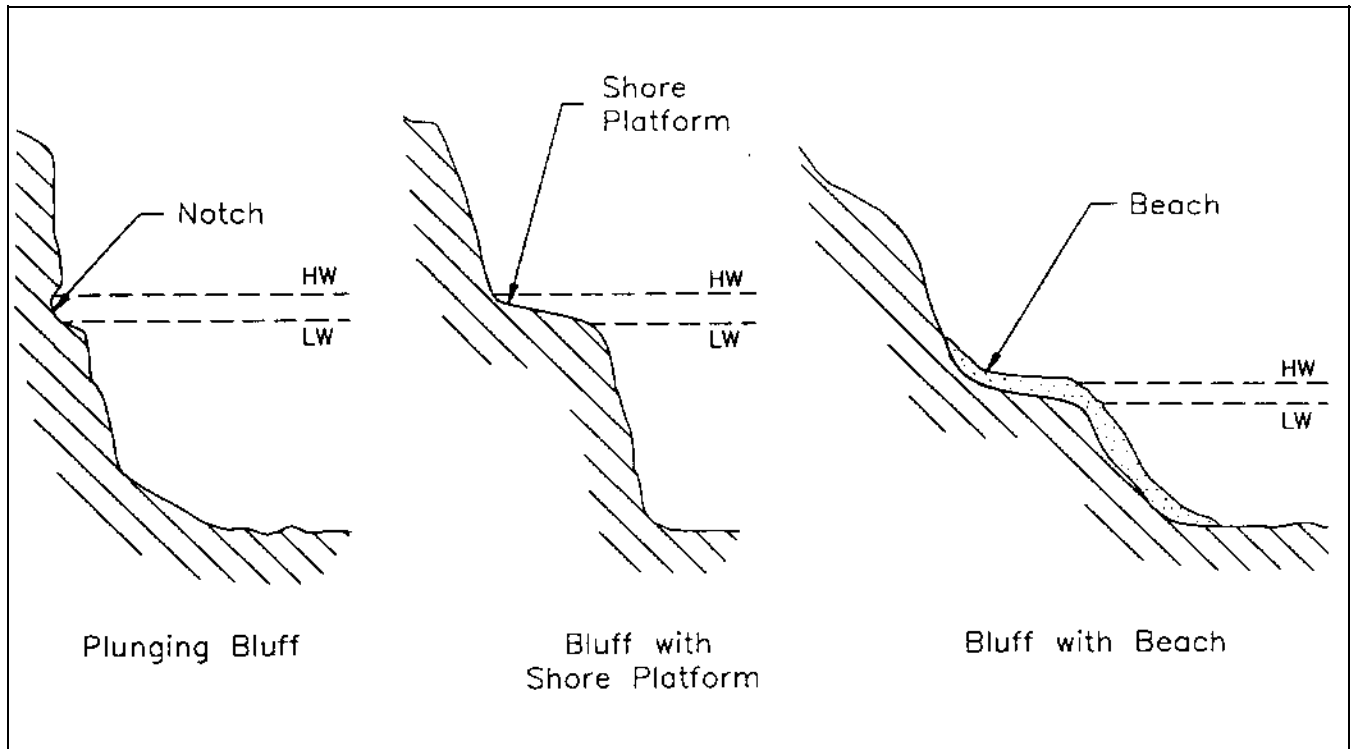

Figure 4-32. Variety of bluff morphology along cohesive shorelines (from Mossa, Meisburger, and Morang (1992))

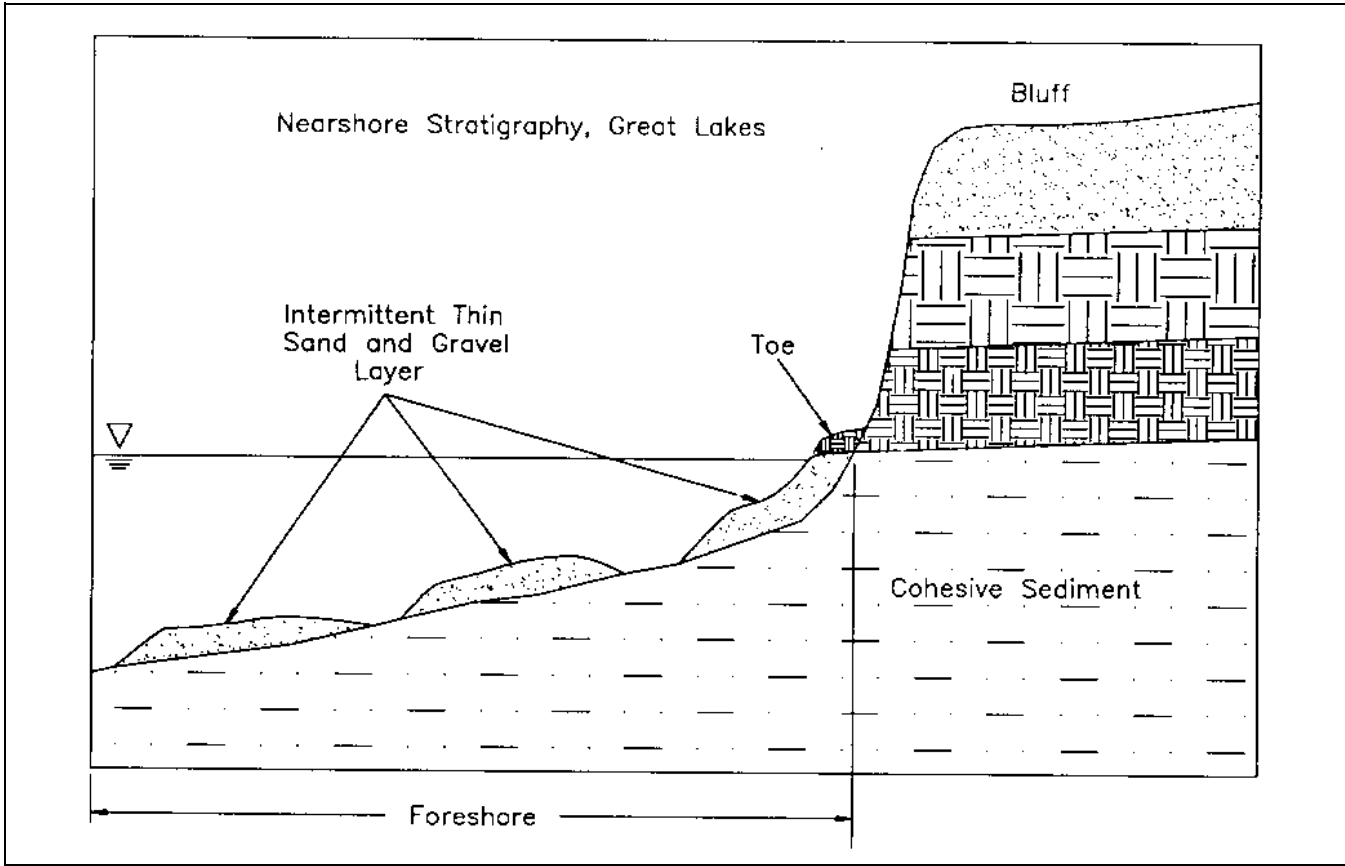

Figure 4-33. Characteristics of Great Lakes cohesive shorelines (great vertical exaggeration)

Chapter 5 Coastal Geological Investigations¹

5-1. Introduction

a. Three principal time scales are important in assessing the geologic and geomorphic² changes of coasts. These include: (1) modern studies, which are based largely on field data or laboratory and office experiments of environmental processes; (2) historic studies, which are based largely on information from maps, photography, archives, and other sources; and (3) studies of paleo-environments, which are based largely on stratigraphy and associated geological principles (Figure 5-1). These general categories overlap. Furthermore, within each of the categories, certain time scales may be of particular importance for influencing coastal changes. For example, tidal and seasonal changes are significant in modern studies, and Holocene sea level history is important in paleo-environmental studies. Tidal fluctuations are difficult to detect in studies of paleoenvironmental changes, and sea level typically changes too slowly to be an important factor in modern process studies.

b. Several lines of inquiry are available to assess the geologic and geomorphic history of coasts. One means of acquiring coastal data is through field data collection and observation. These data may be numerical or non-numerical, and may be analyzed in the field, laboratory, or office. Laboratory studies are used to collect data through physical model experiments, such as in wave tanks, or to analyze geological properties of field data, such as grain size or mineralogy. Office studies include interpretation of historic maps, photographs, and references as well as analyses and numerical simulation of field, laboratory, and office data. Typically, the best overall understanding of environmental processes and the geologic history of coasts is acquired through a broad-based combination of techniques and lines of inquiry.

c. Quality of results depends on several factors, including the use of existing data. If secondary data sources (i.e. existing maps, photography, and literature sources) are limited or unavailable, assessing the geologic

history will be more difficult, more costly, and typically more inaccurate. Consequently, before initiating detailed field, laboratory, or office studies, thorough literature review and search for secondary data sources should be conducted. Appendices E and F list sources and agencies that can be consulted in searches for secondary data.

d. Quality of research equipment, techniques, and facilities also influences the quality of the evaluation of geologic and geomorphic history. For example, echo-sounding and navigation instruments used to conduct bathymetric surveys have recently been improved. Using these tools, the mapping of geologic and geomorphic features can be extended further seaward to a higher degree of accuracy than was previously possible. It is important that coastal researchers stay abreast of new techniques and methods, such as remote sensing and geophysical surveys, computer software and hardware developments, and new laboratory methods. For example, recent developments in Geographical Information Systems (GIS) enable the coastal scientist to analyze and interpret highly complex spatial data sets. This report describes some recent developments and techniques that are used in the analysis of coastal data sets.

e. Scientists must recognize certain problems and assumptions involved in data collection and analyses and make adjustments for them before attempting an interpretation. It is critical to account for various sources of error in preparing estimates of coastal changes and acknowledge the limitations of interpretations and conclusions when these are based on data covering a short time period or a small area.

f. Many of the techniques used to monitor processes and structures in the coastal zone are exceedingly complex. This chapter outlines some of the many errors that can occur when the inexperienced user deploys instruments or accepts, without critical appraisal, data from secondary sources. The text is not intended to be so pessimistic that it dissuades coastal researchers from continuing their investigations, but rather is intended to guide them to other references or to specialists where expert advice can be obtained.

5-2. Sources of Existing Coastal Information

a. Literature sources.

(1) University and college departments and libraries. In many instances, books, periodicals, dissertations, theses, and faculty research project reports contain data.

¹ Chapter 5 is an adaptation of Morang, Mossa, and Larson (1993), with new material added.

² Geomorphic refers to the description and evolution of the earth's topographic features - surficial landforms shaped by winds, waves, ice, flowing water, and chemical processes.

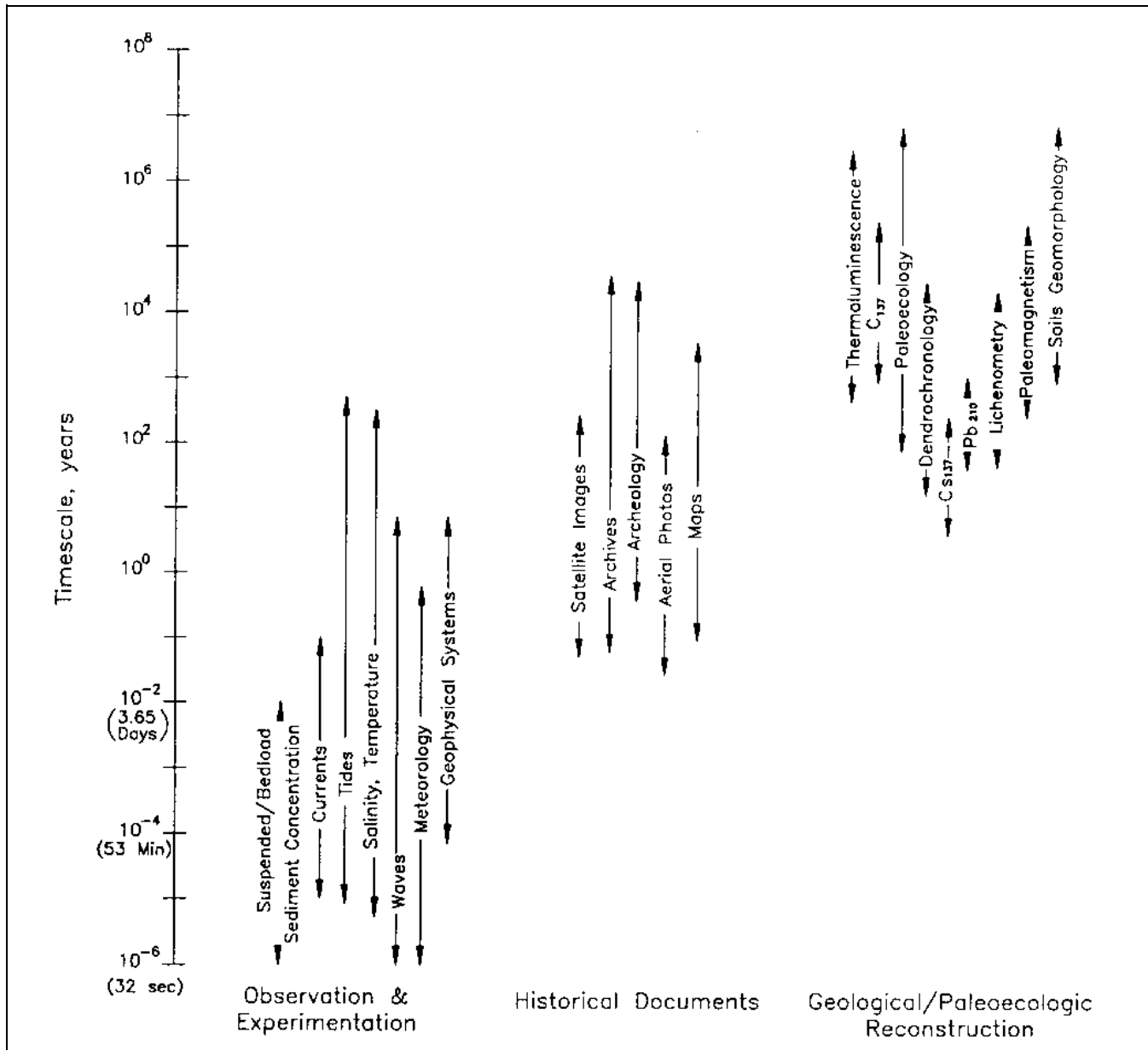

Figure 5-1. Techniques for studying geomorphic changes of coasts over various time scales. Arrows indicate approximate time span during which a particular study technique can be used. X-axis is unitless; width of outlines represent relative importance of general methods for studying coastal changes

This especially occurs when the institutions are in coastal areas, where research is funded by Federal or state government agencies (i.e. Sea Grant), where the university has graduate programs and faculty active in research in appropriate fields. Major universities also have government document repositories where Federal and state government publications are housed.

(2) Local sources. These can provide detailed and sometimes unique data pertinent to the locale. Such

sources include the local newspaper, courthouse records, historical diaries, lighthouse records, local journals, engineering contract records, land transactions, and museums.

(3) Government agencies. Geologic coastal data may be available from government agencies at the Federal, state, and local level (Appendices E and F). Federal agencies with data archives include the U.S. Geological Survey (USGS), the U.S. Coast and Geodetic Survey (USCGS), the National Oceanographic and Atmospheric

Agency (NOAA), the U.S. Army Corps of Engineers (USACE), (including the Waterways Experiment Station, and USACE District and Division offices), the Department of Transportation, the Environmental Protection Agency, the U.S. Fish and Wildlife Service, and the Naval Research Laboratory (NRL). A geographic list of CERC coastal geologic and monitoring reports is provided in Appendix G. State agencies with relevant coastal information include state geological surveys (or bureaus of geology), departments of transportation, departments of environmental resources and/or water resources, and state planning departments. Some state health departments archive well logs.

(4) Industry. Energy (oil and gas) companies often keep records, which may be accessible to scientists, of coastal processes in conjunction with their offshore drilling operations. Construction companies have records in files on their construction projects. Environmental and engineering firms may also have data from projects that were performed for government. Some of these data are in the public domain. Environmental impact reports from nuclear power plants built in coastal areas contain extensive coastal process and geologic data.

(5) Journals and conference proceedings. Most large university libraries have holdings of national and international scientific journals. Most of the scientific literature associated with the geologic history of coasts is in the realm of geology, oceanography, marine science, physical geography, atmospheric science, earth science and polar studies.

(6) Computerized literature searches. Most major university and government agency libraries have access to computerized literature databases. The databases contain information that may be acquired by key terms, subjects, titles, and author names.

b. Meteorological and climatic data.

(1) Meteorological and climatic data are often useful for characterizing significant environmental processes and for revealing the characteristics of severe storms. Major storms or long-term variations in storminess strongly affect coastal morphology (Carter 1988). This is manifested, for example, by the changes on barrier beaches associated with winds, waves, and high water levels, which may cause overtopping and overwashing during storms.

(2) Meteorological and climatic data can be compiled from secondary sources or through an original data

collection program in the field using instruments and observations. As with most of the important environmental factors, most existing information pertains to studies over historic and modern time scales. The National Climatic Data Center and the National Hurricane Center within NOAA are important sources of meteorological and climatic data.

c. Wave data.

(1) Wave data are required to characterize the process-response framework of the coastal zone. Important wave parameters include wave height, period, steepness and direction, and breaker type. Of special interest is the character of waves inside the breaker zone, where it is estimated that 50 percent of sediment movement takes place, mostly as bed load (Ingle 1966). Wave data can be: (a) collected from existing sources; (b) estimated in the office using hindcast techniques from weather maps, shipboard observations, and littoral environment observations; or (c) measured in the field using instrumented wave gauges.

(2) Wave gauge data are collected by Federal and state agencies and by private companies. For research projects that require wave data, analyzed wave statistics may be available if instrumented buoys, offshore structures, and piers are located near the study site. Published data, which are geographically spotty, include statistics from wave gauges, wave hindcasting, and visual observations from shipboard or the littoral zone.

(3) Wave hindcasting is a technique widely used for estimating wave statistics by analysis of weather maps using techniques developed from theoretical considerations and empirical data. A coastal scientist can use published hindcast data or may choose to compute original estimates for a study area. Appendix D is a list of the USACE Wave Information Studies reports, which cover the Atlantic, Pacific, Gulf of Mexico, and Great Lakes coasts. Advantages of hindcasting include the long-term database associated with weather maps and the comparatively economic means of obtaining useful information. Disadvantages involve the transformation of waves into shallow water, especially in areas of complex bathymetry.

(4) Visual wave observations from ships at sea and from shore stations along the coasts of the United States are also published in several references. Although observations are less accurate than measured data, experienced persons can achieve reasonably accurate results and the great amount of observations available make it a valuable resource. Offshore, shipboard wave observations have

been compiled by the U.S. Navy Oceanographic Research and Development Activity, (now the Naval Research Laboratory (NRL)), in the form of sea and swell charts and data summaries such as the Summary of Shipboard Meteorological Observations. While geographic coverage by these sources is extensive, the greatest amount of observations come from shipping lanes and other areas frequented by ship traffic.

(5) At the shore, a program sponsored by HQUSACE for data collection is the Littoral Environmental Observation (LEO) program (Schneider 1981; Sherlock and Szuwalski 1987). The program, initiated in 1966, makes use of volunteer observers who make daily reports on conditions at specific sites along the coasts of the United States. Data from over 200 observation sites are available from CERC (Figure 5-2). As shown, LEO data not only include wave parameters, but also information on winds, currents, and some morphologic features. LEO is best applied to a specific site, and does not provide direct information on deepwater statistics. The biggest disadvantage is the subjective nature of the wave height estimates. LEO data should only be used as indicators of long-term trends, not as a database of absolute values.

d. Sources of water level data. The NOS of the NOAA is responsible for monitoring sea level variations at 115 station locations nationwide (Hicks 1972). Coastal USACE District offices collect tidal elevation data at additional locations. Daily readings are published in reports that are titled "Stages and Discharges of the (location of district office) District." Predicted water levels and tidal current information for each day can be obtained from the annual "Tide Tables: High and Low Water Predictions" and "Tidal Current Tables" published by the NOS. A convenient way to obtain daily tides is from commercial personal computer (PC) programs. Many of these programs are updated quarterly or yearly. Background information concerning tidal datums and tide stations can be found in NOS publications titled "Index of Tide Stations: United States of America and Miscellaneous Other Stations," and "National Ocean Service Products and Services Handbook."

e. Geologic and sediment data.

It is often important in studies of the geologic and geomorphic history of coasts to evaluate existing geologic and sediment data. This type of information is dispersed among numerous agencies and sources and includes a variety of materials such as geologic maps, soil surveys, highway borings, and process data such as the

concentrations and fluxes of suspended sediment from nearby rivers. Published data are available from agencies such as the USGS, the U.S. Soil Conservation Service, the American Geological Institute, and CERC. Differences in geology and soil type may provide clues toward understanding erosion and accretion patterns. Geologic and sedimentologic data are often useful for characterizing significant environmental processes and responses, such as the effects of severe storms on coastlines.

f. Aerial photography.

(1) Historic and recent aerial photographs provide invaluable data for the interpretation of geologic and geomorphic history. The photographs can be obtained from Federal and state government agencies such as the USGS, the U.S. Department of Agriculture, the EROS Data Center, and others listed in the Appendices E and F. Stereographic pairs with overlap of 60 percent are often available, allowing very detailed information to be obtained using photogrammetric techniques. Temporal coverage for the United States is available from the 1930's to present for most locations. The types of analysis and interpretation that can be performed depend in part on the scale of the photographs, the resolution, and the percentage of cloud cover. The effects of major events can be documented by aerial photography because the photographic equipment and airplane can be rapidly mobilized. By such means, the capability exists for extensive coverage in a short time and for surveillance of areas that are not readily accessible from the ground.

(2) For modern process studies, a series of aerial photographs provides significant data for examining a variety of problems. Information pertinent to environmental mapping and classification such as the nature of coastal landforms and materials, the presence of engineering structures, the effects of recent storms, the locations of rip currents, the character of wave shoaling, and the growth of spits and other coastal features can be examined on aerial photographs. For the assessment of some morphologic features, photogrammetric techniques may be helpful. It is generally preferable to obtain photography acquired during low tide so that nearshore features are exposed or partly visible through the water.

(3) For studies over historical time scales, multiple time series of aerial photographs are required. Historical photography and maps are integral components of shoreline change assessments. Water level and, therefore, shoreline locations, show great variation according to when aerial photographic missions were flown.

LITTORAL ENVIRONMENT OBSERVATIONS				
RECORD ALL DATA CAREFULLY AND LEGIBLY				
<u>SITE NUMBERS</u>	<u>YEAR</u>	<u>MONTH</u>	<u>DAY</u>	<u>TIME</u>
<input type="text"/> <input type="text"/> <input type="text"/> <input type="text"/> <input type="text"/> 1 2 3 4 5	<input type="text"/> <input type="text"/> 6 7	<input type="text"/> <input type="text"/> 8 9	<input type="text"/> <input type="text"/> 10 11	<input type="text"/> <input type="text"/> <input type="text"/> <input type="text"/> 12 13 14 15
<p><u>WAVE PERIOD</u></p> <p>Record the time in seconds for eleven (11) wave <u>crests</u> to pass a stationary point. If calm record 0.</p> <p style="text-align: center;"> <input type="text"/> <input type="text"/> <input type="text"/> 16 17 18 </p>		<p><u>BREAKER HEIGHT</u></p> <p>Record the best estimate of the average wave height to the nearest length of a foot.</p> <p style="text-align: center;"> <input type="text"/> <input type="text"/> <input type="text"/> 19 20 21 </p>		
<p><u>WAVE ANGLE AT BREAKER</u></p> <p>Record to the nearest degree the direction the waves are coming from using the protractor on the following page. 0 if calm</p> <p style="text-align: center;"> <input type="text"/> <input type="text"/> <input type="text"/> 22 23 24 </p>		<p><u>WAVE TYPE</u></p> <p>0-Calm 3-Surging 1-Spilling 4-Spill/Plunge 2-Plunging</p> <p style="text-align: right;"> <input type="text"/> 25 </p>		
<p><u>WIND SPEED</u></p> <p>Record wind speed to the nearest mph. If calm record 0.</p> <p style="text-align: center;"> <input type="text"/> <input type="text"/> 26 27 </p>		<p><u>WIND DIRECTION</u></p> <p>Direction the wind is coming.</p> <p>1-N 3-E 5-S 7-W 0-Calm 2-NE 4-SE 6-SW 8-NW</p> <p style="text-align: right;"> <input type="text"/> 28 </p>		
<p><u>FORESHORE SLOPE</u></p> <p>Record foreshore slope to the nearest degree.</p> <p style="text-align: center;"> <input type="text"/> <input type="text"/> 29 30 </p>		<p><u>WIDTH OF SURF ZONE</u></p> <p>Estimate in feet the distance from shore to breakers, if calm record 0.</p> <p style="text-align: center;"> <input type="text"/> <input type="text"/> <input type="text"/> <input type="text"/> 31 32 33 34 </p>		
<p><u>LONGSHORE CURRENT</u></p> <p><u>CURRENT SPEED</u></p> <p>Measure in feet the distance the dye patch is observed to move during minute period; if no longshore movement record 0.</p> <p style="text-align: center;"> <input type="text"/> <input type="text"/> <input type="text"/> 43 44 45 </p>		<p><u>DYE</u></p> <p>Estimate distance in feet from shoreline to point of dye injection.</p> <p style="text-align: center;"> <input type="text"/> <input type="text"/> <input type="text"/> 36 37 38 </p> <p><u>CURRENT DIRECTION</u></p> <p>0 No longshore movement +1 Dye moves toward right -1 Dye moves toward left</p> <p style="text-align: right;"> <input type="text"/> <input type="text"/> 46 47 </p>		

NES FORM 2397 R-Oct 93 EDITION OF 8 MAR 72 IS OBSOLETE.

Figure 5-2. Littoral Environmental Observation forms used by volunteer observers participating in the LEO program (draft) (Continued)

RIP CURRENTS

If rip currents are present, indicate spacing (feet). If spacing is irregular estimate average spacing. If no rips record 0.

49 50 51 52

BEACH CUSPS

If cusps are present, indicate spacing (feet). If spacing is irregular estimate average spacing. If no cusps record 0.

54 55 56

BEACH WIDTH

Measure the distance of the most seaward Beach Berm crest from a reference point to the nearest foot.

57 58 59 60

PLEASE PRINT:

SITE NAME

OBSERVER

Please Check The Form For Completeness

REMARKS:

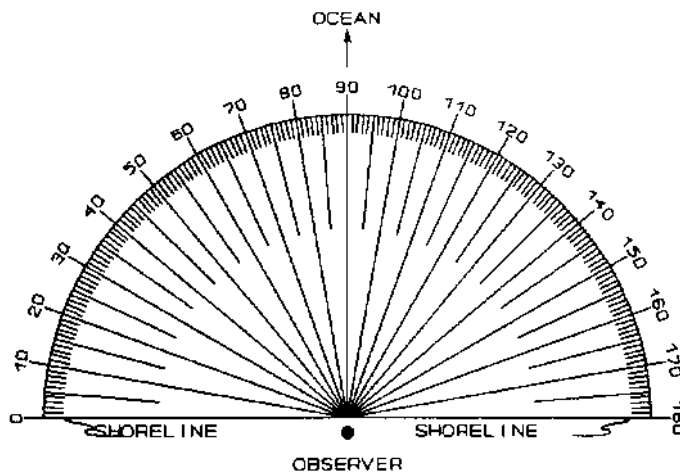

NOTE: If a pier is used for an observation platform: place 0-180 line on the rail parallel to the centerline of the pier, sight along the crest of the breaking waves and record the angle observed

Figure 5-2. (Concluded)

Therefore, the coastal scientist should account for such variations as potential sources of error in making or interpreting shoreline change maps. Section 5-5 contains a more detailed discussion of aerial photograph analysis.

g. Satellite remotely sensed data.

(1) Satellite data are available from U.S. agencies, the French Systeme Pour L'Observation de la Terre (SPOT) satellite data network, and from Russian coverage.¹ In most instances, the data can be purchased either as photographic copy or as digital data tapes for use in computer applications. Imagery and digital data may assist in understanding large-scale phenomena, especially processes which are indicators of geologic conditions and surface dynamics. Agencies that collect and distribute satellite data are listed in Appendix E. Numerous remote sensing references are listed in Lampman (1993). A listing of satellite data maintained by the National Space Science Data Center (NSSDC) is printed in Horowitz and King (1990). This data can be accessed electronically.

(2) Satellite data are especially useful for assessing large-scale changes of the surface of the coastal zone. In the vicinity of deltas, estuaries, and other sediment-laden locations, spatial patterns of suspended sediment can be detected with remote sensing (Figure 5-3). In shallow non-turbid water bodies, some features of the offshore bottom, including the crests of submarine bars and shoals, can be imaged. The spatial extent of tidal flows may be determined using thermal infrared data, which can be helpful in distinguishing temperature differences of ebb and flood flows and freshwater discharges in estuaries. In deeper waters, satellites can also provide data on ocean currents and circulation (Barrick, Evans, and Weber 1977). Aircraft-mounted radar data also show considerable promise in the analysis of sea state.

(3) The Landsat satellite program was developed by the National Aeronautics and Space Administration in cooperation with the U.S. Department of the Interior. When it began in 1972, it was primarily designed as an experimental system to test the feasibility of collecting earth resource data from unmanned satellites. Landsat satellites have used a variety of sensors with different wavelength sensitivity characteristics, ranging from the visible (green) to the thermal infrared with a maximum

wavelength of 12 micrometers (μm). Figure 5-4 shows bandwidths and spatial resolution of various satellite sensors. Of the five Landsat satellites, only Landsat-4 and Landsat-5 are currently in orbit. Both are equipped with the multispectral scanner, which has a resolution of 82 m in four visible and near-infrared bands, and the thematic mapper, which has a resolution of 30 m in six visible and near- and mid-infrared bands and a resolution of 120 m in one thermal infrared band (10.4-12.5 μm).

(4) SPOT is a commercial satellite program. The first satellite, which was sponsored primarily by the French government, was launched in 1986. The SPOT-1 satellite has two identical sensors known as HRV (high-resolution-visible) imaging systems. Each HRV can function in a 10-m resolution panchromatic mode with one wide visible band, or a 20-m resolution multispectral (visible and near infrared) mode with three bands (Figure 5-3).

(5) Several generations of satellites have flown in the NOAA series. The most recent ones contain the Advanced Very High Resolution Radiometer (AVHRR). This provides increased aerial coverage but at much coarser resolution than the Landsat or SPOT satellites. More information on the wide variety of satellites can be found in textbooks on remote sensing (i.e. Colwell 1983, Lillesand and Kiefer 1987, Richards 1986, Sabins 1987, Siegal and Gillespie 1980, Stewart 1985).

(6) Aircraft-mounted scanners, including thermal sensors and radar and microwave systems, may also have applications in coastal studies. LIDAR (light detection and ranging), SLAR (Side-Looking Airborne Radar), SAR (Synthetic Aperture Radar), SIR (shuttle imaging radar), and passive microwave systems have applications including mapping of bottom contours of coastal waters. A LIDAR system, known as SHOALS (Scanning Hydrographic Operational Airborne Lidar System), is now being used by the U.S. Army Corps of Engineers to profile coastal areas and inlets. The system is based on the transmission and reflection of a pulsed coherent laser light from a helicopter equipped with the SHOALS instrument pod and with data processing and navigation equipment (Lillycrop and Banic 1992). In operation, the SHOALS laser scans an arc across the helicopter's flight path, producing a survey swath equal to about half of the aircraft altitude. A strongly reflected return is recorded from the water surface, followed closely by a weaker return from the seafloor. The difference in time of the returns is converted to water depth. SHOALS may revolutionize hydrographic surveying in shallow water for several

¹Russian Sojuzkarta satellite photographs are available from Spot Image Corporation (Appendix E). Almaz synthetic aperture radar data are available from Hughes STX Corporation.

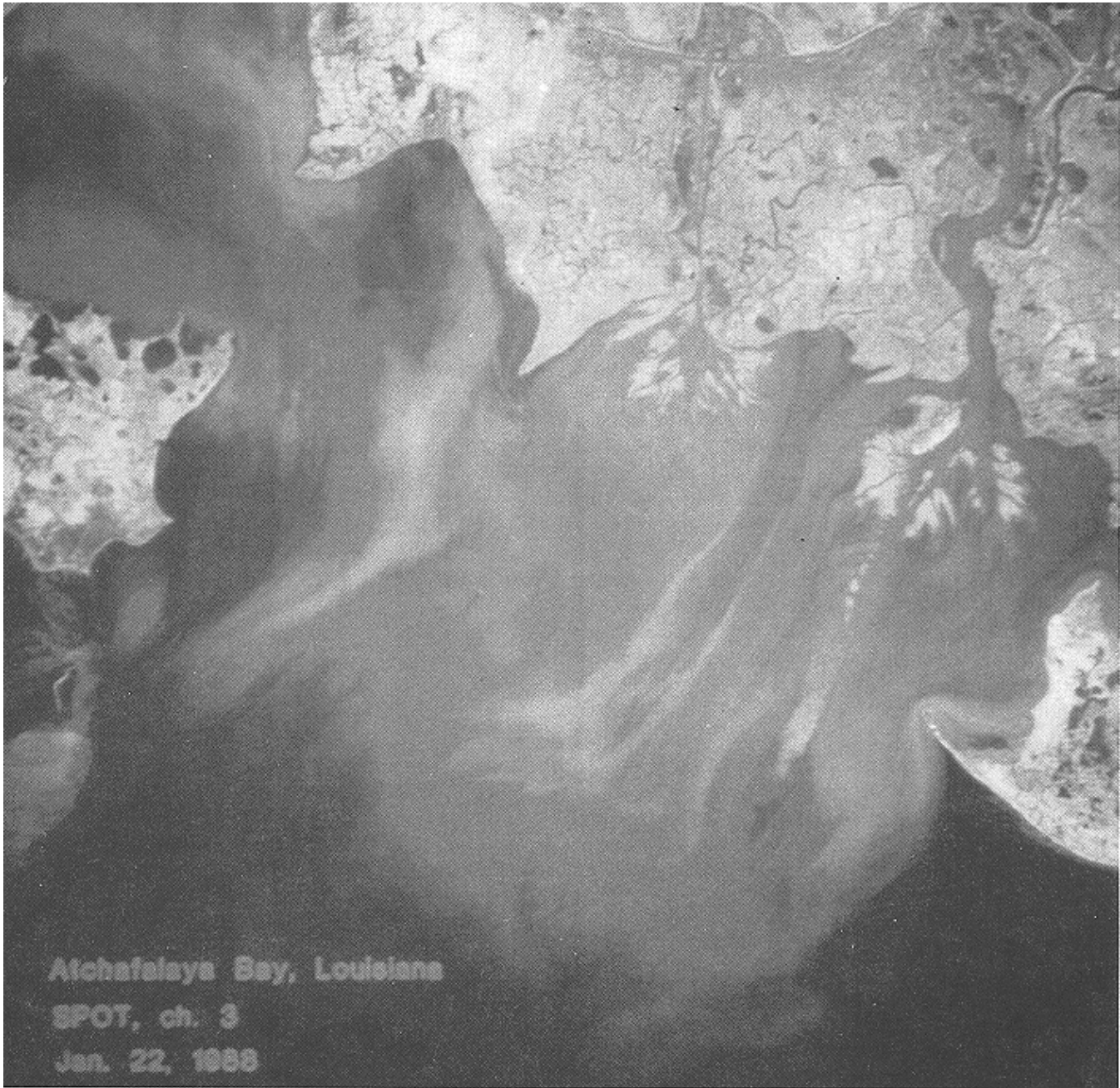

Figure 5-3. SPOT satellite image, Atchafalaya Bay, LA. Suspended sediment from runoff is clearly visible. Data processed by the Earthscan Laboratory, School of Geosciences, Louisiana State University, Baton Rouge, LA

reasons. The most important advantage is that the system can survey up to 8 square km per hour, thereby covering large stretches of the coast in a few days. This enables almost instantaneous data collection along shores subject to rapid changes. The system can be mobilized quickly, allowing large-scale post-storm surveys or surveys of unexpected situations such as breaches across barriers.

Finally, minimum survey water depth is only 1 m; this allows efficient coverage of shoals, channels, or breaches that would normally be impossible or very difficult to survey using traditional methods, especially in winter. Maximum survey depth is proving to be about 10 m, depending on water clarity.

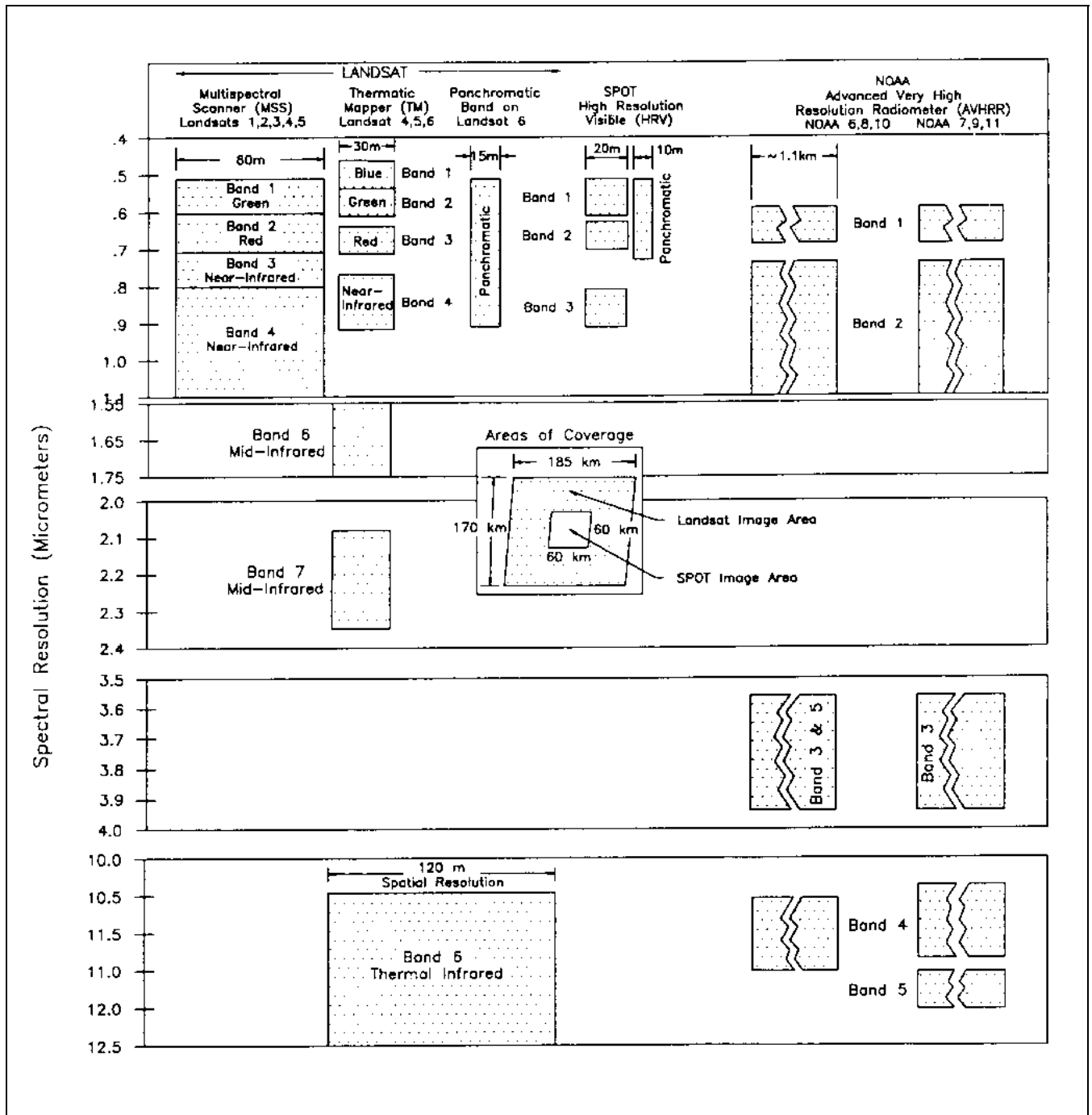

Figure 5-4. Spectral resolution and approximate spatial resolution of sensors on Landsat, SPOT, and NOAA satellites (from Earth Observation Satellite Company literature and Huh and Leibowitz (1986))

h. Topographic and bathymetric data.

(1) Topographic and bathymetric maps are available from the USGS, many USACE District Offices, and the USCGS. USGS topographic maps are generally revised every 20 to 30 years, and sometimes more often in areas

determined to be of high priority. Nevertheless, the maps may be outdated for some studies because of the ephemeral nature of many coastlines. The USGS quadrangles are available in a 7.5' series (scale 1:24,000) and a 15' series (scale 1:62,500). The resolution of these maps is typically inadequate to provide details of surface

features, but may be sufficient for examining large landforms and pronounced changes, particularly over long periods.

(2) Recent and historic hydrographic survey data are available from the National Ocean Survey (NOS). Much of this data can be obtained in the form of preliminary plots that are of larger scale and contain more soundings and bottom notations than the published charts made from them.

(3) Bathymetric survey maps are sometimes out of date because geomorphic changes in many submarine areas occur rapidly. On some navigation charts, the bathymetry may be more than 50 years old and the marked depths may be quite different from actual depths. The greatest changes can be areas of strong current activity, of strong storm activity, of submarine mass movement, and of dredging near ship channels. The user must also be aware of changes in the datum used in different maps. Annual or more frequent hydrographic surveys are available at most Federal navigation projects.

i. Shoreline change maps.

(1) Shoreline changes may be interpreted from navigation maps, topographic maps, aerial photographs, and property records. In some areas, maps showing shoreline changes and land loss may have been produced by state and federal agencies, universities, or engineering firms. However, the user should be aware of potential sources of error which may not have been adequately corrected when these maps were prepared.

(2) Shoreline and coastal change maps that are constructed from historic maps and photographs are subject to numerous sources of error. For example, maps may not have common datums, may have different scales, may have variable accuracy due to age or loss of accuracy in publication procedures, and may be based on different projections which in turn cause geometric distortions. Ideally, shoreline change maps constructed from aerial photographs should be corrected for distortions caused by pitch, tilt, and yaw of the aircraft. Difficulties in identifying common points over time, problems in rectifying scale, and distortions near margins and corners are common. Additional problems include the unavailability of photographs of the desired vintage, scale, clarity, or resolution. Haze, fog, and cloud cover may obscure ground features. Finally, the water level at the time that the photographs were taken can greatly influence the position of the shorelines. Specific data sources and procedures

for analyzing shoreline change maps are presented in section 5-5.

5-3. Field Data Collection and Observation

a. Background.

(1) In order to apply appropriate technologies to a field study, the coastal scientist should know something about the nature of the problem and the expected outcome. For example, if a community is being threatened by erosion, measurements of processes, topography, and bathymetry are needed to determine storm-induced and long-term erosion trends. Also, studies of historical data may be required to determine the rates and spatial variability of shoreline change over time. Studies involving stratigraphy may be required if the purpose is to find local sources of borrow material for beach nourishment. Design of a research study must include thorough planning of objectives and sampling strategies, given time, logistic, and budget constraints. Much time and effort can be wasted during a field study if the research objectives are not well-defined and the sampling plan is inappropriate.

(2) Before undertaking detailed field studies, it is important to review all available coastal data pertinent to the study area and problems. The existing information is critical to the effective design of field studies and can result in more cost-effective field work. Often, time and budget constraints may severely limit data collection, making available data even more important.

(3) While in the field, relevant data and information should be meticulously recorded in water-resistant field books. Details can also be recorded on a tape recorder. Photographs serve as valuable records of field conditions, sampling equipment, and procedures. Video recorders are being increasingly used during field reconnaissance.

(4) The type of work conducted in the field may fall into several categories. It may range from a simple visual site inspection to a detailed collection of process measurements, sediment samples, stratigraphic samples, topographic and bathymetric data, and geophysical data. Studies may include exploring the acting forces, rates of activity, interactions of forces and sediments, and variations in activity over time. If the field work will involve extensive data collection, a preliminary site visit is highly recommended to help determine site conditions and to develop a sampling plan.

(5) Spatial and temporal aspects of site inspection are important considerations. The spatial dimensions of the sampling plan should have adequate longshore and cross-shore extent and an adequate grid or sample spacing with which to meet study objectives. Temporal considerations include the frequency of sampling and the duration over which samples will be collected. Sampling frequency and duration are most important in modern process studies, such as monitoring the topographic and bathymetric changes associated with storms. Studies of paleoenvironmental or geologic time scales usually do not require repetitive visits, but thorough spatial sampling is critical.

(6) A conceptual model is essential before designing a field data collection program. This "model" is a set of working hypotheses which use existing knowledge to organize missing information. As information is acquired, the conceptual model is revised and validated. Additional observations may be required to test a wider variety of conditions, and conceptual models may need to be revised depending on the results of the study.

b. Site inspection and local resources.

(1) A general site inspection can provide insights toward identifying significant research problems at a study area, in verifying and enhancing data from aerial photographs and remote sensing sources, and in developing sampling strategies for more rigorous field work. Even for a brief site visit, thorough preparation is strongly recommended. Preparation should include reviewing the pertinent geologic, oceanographic, and engineering literature, compiling maps and photographs, and understanding the scope of the problem or situation. The field inspection should include observations by all members to be involved in the project, if at all possible.

(2) The duration of the field examination must be sufficient to assess the major objectives of the study. Local residents, existing data records, and field monitoring equipment may need to be used. A site inspection should include observation of marine forces and processes, assessment of geomorphic indicators, visits to neighboring sites, and interviews with residents and other local or knowledgeable individuals. Questions to be asked might include what, why, when, where, and how come? Why does this section of the shore look as it does? How do humans influence the local environment? Is the problem geologic (natural) or man-made? Do catastrophic events, such as hurricanes, appear to have much impact on the region? A checklist of data to be collected at a coastal site visit is presented in Appendix H. A handy field notebook of geologic data sheets is

published by the American Geologic Institute (Dietrich, Durto, and Foose 1982).

c. Photographs and time sequences. Photography is often an important tool for initial reconnaissance work as well as for more detailed assessments of the study area. One special application of cameras involves the use of time-lapse or time interval photography, which may be helpful in studies of geomorphic variability to observe shoreline conditions, sand transport (Cook and Gorsline 1972), and wave characteristics. If the camera is set to record short-term processes, relatively frequent photographs are typically obtained. If historic ground photographs are available, additional pictures can be acquired from the same perspective. Changes in an area over time, applicable to both short- and long-term studies, can also be recorded with video photography. It is important that pertinent photographic information be recorded in a field log:

- Date.
- Time.
- Camera location.
- Direction of each photograph.
- Prominent landmarks, if any.

Date, location, and direction should be marked on slide mounts for each exposure.

d. Wave measurements and observations. It is often relevant in studies of historic and process time scales to obtain data regarding wave conditions at the site. Instrumented wave gauges typically provide the most accurate wave data. Unfortunately, wave gauges are expensive to purchase, deploy, maintain, and analyze. Often, they are operated for a short term to validate data collected by visual observation or hindcasting methods. Multiple gauges, set across the shore zone in shallow and deep water, can be used to determine the accuracy of wave transformation calculations for a specific locale.

(1) Types of wave gauges.

(a) Wave gauges can be separated into two general groups: directional and non-directional. In general, directional gauges and gauge arrays are more expensive to build, deploy, and maintain than non-directional gauges. Nevertheless, for many applications, directional

instruments are vital because the directional distribution of wave energy is an important parameter in many applications, such as sediment transport analysis and calculation of wave transformation. Wave gauges can be installed in buoys, placed directly on the sea or lake bottom, or mounted on existing structures, such as piers, jetties, or offshore platforms.

(b) Of the non-directional wave gauges, buoy-mounted systems such as the Datowell Waverider are accurate and relatively easy to deploy and maintain. Data are usually transmitted by radio between the buoy and an onshore receiver and recorder. Bottom-mounted pressure gauges measure water level changes by sensing pressure variations with the passage of each wave. The gauges are either self-recording or are connected to onshore recording devices with cables. Bottom-mounted gauges must be maintained by divers unless the mount can be retrieved by hoisting from a workboat. Internal-recording gauges usually need more frequent maintenance because the data tapes must be changed or the internal memory downloaded. Advantages and disadvantages of self-contained and cable-telemetered gauges are listed in Table 5-1. Structure-mounted wave gauges are the most economical and most accessible of the non-directional gauges, although their placement is confined to locations where structures exist. The recording devices and transmitters can be safely mounted above water level in a protected location.

(c) Directional wave gauges are also mounted in buoys or on the seafloor (Figure 5-5). Arrays of non-directional gauges can be used for directional wave analyses. Directional buoy-type wave gauges are often designed to collect other parameters such as meteorology.

(2) Placement of wave gauges. The siting of wave gauges along the coast depends on the goals of the monitoring project, funds and time available, environmental hazards, and availability of previously collected data. There are no firm guidelines for placing gauges at a site, and each project is unique. There are two approaches to wave gauging: one is to deploy instruments near a project site in order to measure the wave and sea conditions that directly affect a structure or must be accounted for in designing a project. The second approach is to deploy a gauge further out to sea to measure regional, incident waves. In the past, when wave gauges were exceedingly expensive, researchers often opted to collect regional data with a single instrument. Now, with lower costs for hardware and software, we recommend that several gauges be deployed near the coast flanking the project area. A priori knowledge of a site or practical considerations may

dictate gauge placement. The user must usually compromise between collecting large amounts of data for a short, intensive experiment, and maintaining the gauges at sea for a longer period in order to try to observe seasonal changes. Table 5-2 summarizes some suggested practices based on budget and study goals. Suggestions on data sampling intervals are discussed in Section 5-5.

(3) Seismic wave gauge. Wave estimates based on microseismic measurements are an alternative means to obtain wave data in high-energy environments. Microseisms are very small ground motions which can be detected by seismographs within a few kilometers of the coast. It is generally accepted that microseisms are caused by ocean waves and that the amplitudes and periods of the motions correspond to the regional wave climate. Comparisons of seismic wave gauges in Oregon with in situ gauges have been favorable (Howell and Rhee 1990; Thompson, Howell, and Smith 1985). The seismic system has inherent limitations, but deficiencies in wave period estimates can probably be solved with more sophisticated processing. Use of a seismometer for wave purposes is a long-term commitment, requiring time to calibrate and compare the data. The advantage of a seismograph is that it can be placed on land in a protected building.

e. Water level measurements and observations.

(1) To collect continuous water level data for site-specific, modern process studies, tide gauges must be deployed near the project site. Three types of instruments are commonly used to measure water level:

(a) *Pressure transducer gauges.* These instruments are usually mounted on the seafloor or attached to structures. They record hydrostatic pressure, which is converted to water level during data processing. A major advantage of these gauges is that they are underwater and somewhat inaccessible to vandals. In addition, ones like the Sea Data Temperature Depth Recorder are compact and easy to deploy.

(b) *Stilling-well, float gauges.* These instruments, which have been in use since the 1930's, consist of a float which is attached to a stylus assembly. A clockwork or electric motor advances chart paper past the stylus, producing a continuous water level record. The float is within a stilling well, which dampens waves and boat wakes. The main disadvantage of these gauges is that they must be protected from vandals. They are usually used in estuaries and inland waterways where piles or

**Table 5-1
Self-Contained and Cable-Telemetry Wave Gauges; Advantages and Disadvantages**

I. Self-contained gauges

A. Advantages

1. Deployment is often simple because compact instrument can be handled by a small dive team.
2. Gauge can be easily attached to piles, structural members, or tripods.
3. Field equipment can be carried by airplane to remote sites.
4. Gauges will continue to function in severe storms as long as the mounts survive.
5. Usually easy to obtain permits to deploy instruments (typically, notification to mariners must be posted).

B. Disadvantages

1. Gauge must be periodically recovered to retrieve data or replace storage media.
2. Data collection time is limited by the capacity of the internal memory or data tapes. Researcher must compromise between sampling density and length of time the gauge can be gathering data between scheduled maintenance visits.
3. Battery capacity may be a limiting factor for long deployments.
4. If bad weather forces delay of scheduled maintenance, gauge may reach the limit of its storage capacity. This will result in unsampled intervals.
5. While under water, gauge's performance cannot be monitored. If it fails electronically or leaks, data are usually lost forever.
6. Gauge may be struck by anchors or fishing vessels. The resulting damage or total loss may not be detected until the next maintenance visit.

C. Notes

1. Data compression techniques, onboard data processing, and advances in low-energy memory have dramatically increased the storage capacity of underwater instruments. Some can remain onsite as long as 12 months.

II. Data transmission by cable

A. Advantages

1. Data can be continuously monitored. If a failure is detected (by human analysts or error-checking computer programs), a repair team can be sent to the site immediately.
2. Because of the ability to monitor the gauge's performance, infrequent inspection visits may be adequate to maintain systems.
3. Frequency and density of sampling are only limited by the storage capacity of the shore-based computers.
4. Gauge can be reprogrammed in situ to change sampling program.
5. Electrical energy is supplied from shore.

B. Disadvantages

1. Permitting is difficult and often requires considerable effort.
2. Lightning is a major cause of damage and loss of data.
3. Cable to shore is vulnerable to damage from anchors or fishing vessels.
4. Shore station may be damaged in severe storms, resulting in loss of valuable storm data.
5. Shore station and data cable are vulnerable to vandalism.
6. Backup power supply necessary in case of blackouts.
7. Installation of cable can be difficult, especially in harbors and across rough surf zones.
8. Installation often requires a major field effort, with vehicles on beach and one or two boats. Heavy cable must be carried to the site.
9. Cable eventually deteriorates in the field and must be replaced.
10. Cable may have to be removed after experiment has ended.

C. Notes

1. Some cable-based gauges have internal memory and batteries so that they can continue to collect data even if cable is severed.
2. Ability to constantly monitor gauge's performance is a major advantage in conducting field experiments.

bridges are available for mounting the well and recording box. Figure 5-6 is an example of tide data from Choctawhatchee Bay, Florida.

(c) *Staff gauges.* Water levels are either recorded manually by an observer or calculated from electric resistance measurements. The resistance staff gauges require frequent maintenance because of corrosion and biological fouling. The manual ones are difficult to use at night and

during storms, when it is hazardous for the observer to be at the site.

Typically, water level measurements recorded by gauges are related to an established datum, such as mean sea level. This requires that the gauge elevations be accurately measured using surveying methods. The maximum water level elevations during extreme events can also be

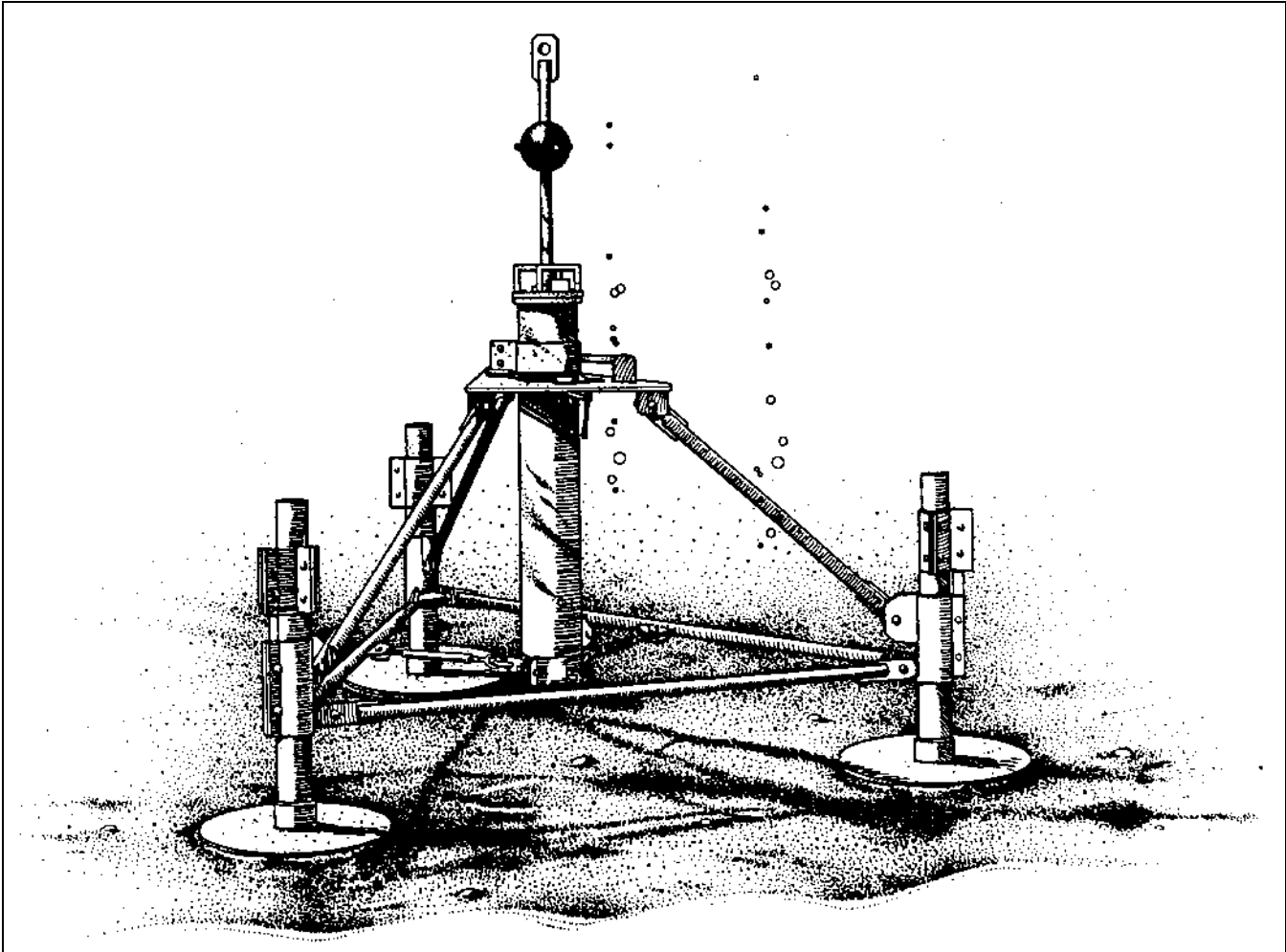

Figure 5-5. Bottom-mounted Sea Data™ 635-12 directional wave gauge mounted in tripod using railroad wheels as corner weights

determined by examining water marks on structures or other elevated features.

(2) Water level information over paleoenvironmental time scales has been investigated by researchers using stratigraphic coring, seismic techniques, and radiometric dating. Petroleum geologists have used seismic stratigraphy to reconstruct ancient sea levels (Payton 1977, Sheriff 1980).

f. Current measurements and observations.

(1) General techniques of current measurement.

(a) The observation of hydraulic phenomena can be accomplished by two general approaches. One of these, Lagrangian, follows the motion of an element of matter in

its spatial and temporal evolution. The other, Eulerian, defines the motion of the water at a fixed point and determines its temporal evolution. Lagrangian current measuring devices are often used in sediment transport studies, in pollution monitoring, and for tracking ice drift. Eulerian, or fixed, current measurements are important for determining the variations in flow over time at a fixed location. Recently developed instruments combine aspects of both approaches.

(b) Four general classes of current measuring technology are presently in use (Appell and Curtin 1990):

- Radar and Lagrangian methods.
- Spatially integrating methods.

**Table 5-2
Suggested Wave Gauge Placement for Coastal Project Monitoring**

I. High-budget project (major harbor; highly populated area)

A. Recommended placement:

1. One (or more) wave gauge(s) close to shore near the most critical features being monitored (example, near an inlet). Although near-shore, gauges should be in intermediate or deep water based on expected most common wave period. Depth can be calculated from formulas in *Shore Protection Manual* (1984).
2. In addition, one wave gauge in deep water if needed for establishing boundary conditions of models.

B. Schedule:

1. Minimum: 1 year. Monitor winter/summer wave patterns (critical for Indian Ocean projects).
2. Optimum: 5 years or at least long enough to determine if there are noticeable changes in climatology over time. Try to include one El Niño season during coverage for North American projects.

C. Notes:

1. Concurrent physical or numerical modeling: Placement of a gauge may need to take into account modellers' requirements for input or model calibration.
2. Preexisting wave data may indicate that gauges should be placed in particular locations. As an alternative, gauges may be placed in locations identical to the previous deployment in order to make the new data as compatible as possible with the older data. **Long, continuous data sets are extremely valuable!**
3. Hazardous conditions: If there is a danger of gauges being damaged by anchors or fishing boats, the gauges must be protected, mounted on structures (if available), or deployed in a location which appears to be the least hazardous.

II. Medium-budget project

A. Recommended placement:

1. One wave gauge close to shore near project site.
2. Obtain data from nearest NOAA National Data Buoy Center (NDBC) buoy for deepwater climatology.

B. Schedule: minimum 1 year deployment; longer if possible

C. Notes: same as IC above. Compatibility with existing data sets is very valuable.

III. Low budget, short-term project

A. Recommended placement: gauge close to project site.

B. Schedule: if 1-year deployment is not possible, try to monitor the season when the highest waves are expected (usually winter, although this may not be true in areas where ice pack occurs).

C. Notes: same as IC above. It is critical to use any and all data from the vicinity, anything to provide additional information on the wave climatology of the region.

- Point source and related technology.
- Acoustic Doppler Current Profilers (ADCP) and related technology.

The large number of instruments and methods used to measure currents underscores that detection and analysis of fluid motion in the oceans is an exceedingly complex process. The difficulty arises from the large continuous scales of motion in the water. As stated by McCullough (1980), "There is no single velocity in the water, but many, which are characterized by their temporal and spatial spectra. Implicit then in the concept of a fluid 'velocity' is knowledge of the temporal and spatial averaging processes used in measuring it. Imprecise, or worse, inappropriate modes of averaging in time and/or space now represent the most prominent source of error in

near-surface flow measurements." McCullough's comments were addressed to the measurement of currents in the ocean. In shallow water, particularly in the surf zone, additional difficulties are created by turbulence and air entrainment caused by breaking waves, by suspension of large concentrations of sediment, and by the physical violence of the environment. Trustworthy current measurement under these conditions becomes a daunting task.

(2) Lagrangian.

(a) Dye, drogues, ship drift, bottles, temperature structures, oil slicks, radioactive materials, paper, wood chips, ice, trees, flora, and fauna have all been used to study the surface motion of the oceans (McCullough 1980). Some of these techniques, along with the use of

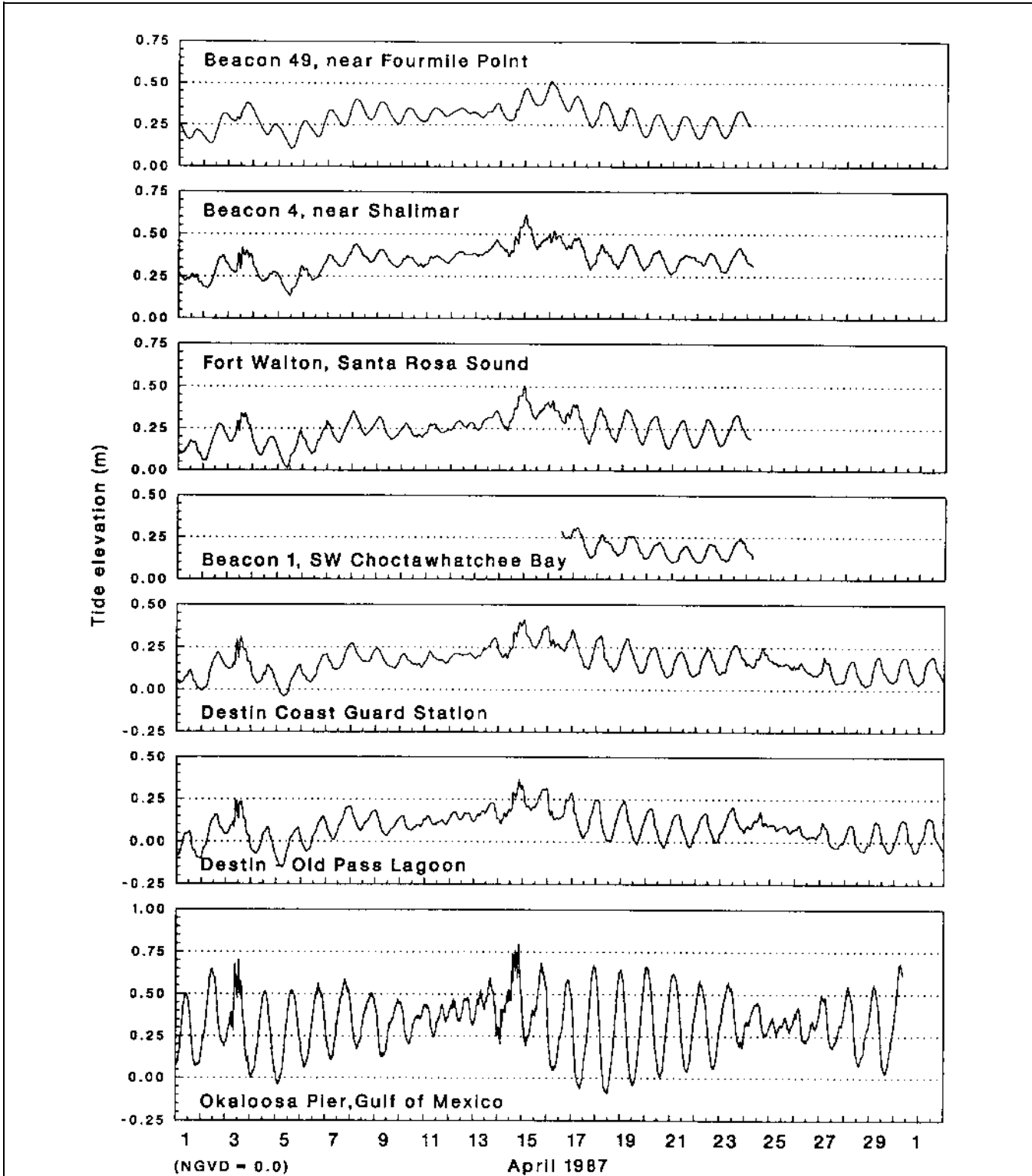

Figure 5-6. Tidal elevations from seven stations in Choctawhatchee Bay, FL, and the Gulf of Mexico. The overall envelope of the seven curves is similar, but individual peaks are shifted in phase from station to station. Original tide records courtesy of U.S. Army Engineer (USAE) District, Mobile

mid-depth drogues and seabed drifters, have been widely used in coastal studies. A disadvantage of all drifters is that they are only quasi-Lagrangian sensors because, regardless of their design or mass, they cannot exactly follow the movement of the water (Vachon 1980). Nevertheless, they are particularly effective at revealing surface flow patterns if they are photographed or video recorded on a time-lapse basis. Simple drifter experiments can also be helpful in developing a sampling strategy for more sophisticated subsequent field investigations. Floats, bottom drifters, drogues, and dye are used especially in the littoral zone where fixed current meters are adversely affected by turbulence. Resio and Hands (1994) analyze the use of seabed drifters and comment on their value in conjunction with other instruments.

(b) High frequency (HF) radar surface-current mapping systems have been tested since the 1970's. The advantage of using the upper high radar frequencies is that these frequencies accurately assess horizontal currents in a mean water depth of only 1 m (total layer thickness about 2 m). Hence, HF radar accurately senses horizontal currents in the uppermost layers of the oceans, where other instruments such as moored current meters and ADCP's become inoperable (Barrick, Lipa, and Lilleboe 1990). Nevertheless, HF radar has had limited success in the oceanography community because of the difficulty in proving measurement accuracy and because of relatively high system costs (Appell and Curtin 1990).

(c) Large-scale coastal circulation can be observed in satellite images, as seen in Figure 5-3.

(3) Spatially integrating methods. To date, experiments in spatially averaging velocity by observing induced electrical fields have been conducted by towing electrodes from ships or by sending voltages in abandoned underwater telephone cables. Some of these experiments have been for the purpose of measuring barotropic flow in the North Pacific (Chave, Luther, and Filloux 1990; Spain 1990 - these two papers provide a substantial summary of the mathematics and methods). This author is unaware of whether these techniques have been tested in shallow water or in restricted waterways such as channels. At this time, therefore, spatially integrating methods appear to have no immediate application to coastal engineering studies.

(4) Point source (Eulerian) and related technology.

(a) In channels, bays, and offshore, direct measurements of the velocity and direction of current flow can be made by instruments deployed on the bottom or at various

levels in the water column. Two general classes of current meters are available: mechanical (impeller-type) and electronic. Several types of electronic current meters are in common use, including electromagnetic, inclinometer, and acoustic travel-time (Fredette et al. 1990, McCullough 1980; Pinkel 1980).

(b) Impeller current meters measure currents by means of a propeller device which is rotated by the current flow. They serve as approximate velocity component sensors because they are primarily sensitive to the flow component in a direction parallel to their axle. Various types of propeller design have been used to measure currents, but experience and theoretical studies have shown that the ducted propellers are more satisfactory in measuring upper ocean currents than rotor/vane meters (Davis and Weller 1980). Impeller/propeller meters are considered to be the most reliable in the surf zone (Teleki, Musialowski, and Prins 1976), as well as the least expensive. One model, the Endeco 174, has been widely used by CERC for many years throughout the country. Impeller gauges are subject to snarling, biofouling, and bearing failures, but are more easily repaired in the field and are more easily calibrated than other types (Fredette et al. 1990).

(c) Electronic current meters have many features in common, although they operate on different principles. Their greatest common advantages are rapid response and self-contained design with no external moving parts. They can be used in real-time systems and can be used to measure at least two velocity components. The degree of experience of the persons working with the instruments probably has more influence on the quality of data acquired than does the type of meter used (Fredette et al. 1990). The InterOcean Systems S4 electromagnetic meter has been successfully used by CERC at field experiments.

(5) ADCPS. These profilers operate on the principle of Doppler shift in the backscattered acoustic energy caused by moving particles suspended in the water. Assuming that the particles have the same velocity as the ambient water, the Doppler shift is proportional to the velocity components of the water within the path of the instrument's acoustic pulse (Bos 1990). The backscattered acoustic signal is divided into parts corresponding to specific depth cells, often termed "bins." The bins can be various sizes, depending upon the depth of water in which the instrument has been deployed, the frequency of the signal pulse, the time that each bin is sampled, and the acceptable accuracy of the estimated current velocity. Much excitement has been generated by ADCP's, both among scientists working in shallow water and in the

deep ocean (a comprehensive bibliography is listed in Gordon et al. (1990)). A great advantage of using ADCP's in shallow water is that they provide profiles of the velocities in the entire water column, providing more comprehensive views of water motions than do strings of multiple point source meters. ADCP data are inherently noisy, and signal processing and averaging are critical to the successful performance of the gauges (Trump 1990).

(6) Indirect estimates of currents. Indirect estimates of current speed and direction can be made from the orientation, size, and shape of bed forms, particularly in shallow water. Widespread use of side-scan sonar has made this type of research possible in bays, inlets, and offshore. Sedimentary structures on the seafloor are caused by the hydrodynamic drag of moving water acting on sediment particles. The form and shape of bottom structures reflect the effects and interaction among tidal currents, waves, riverine flow, and longshore currents. These complex interactions especially affect bedforms in tidal channels and other restricted waterways. Bedforms reflect flow velocity, but are generally independent of depth (Clifton and Dingler 1984; Boothroyd 1985). Their shape varies in response to increasing flow strength (Hayes and Kana 1976). Bedform orientation and associated slipfaces also provide clues to flow direction (Morang and McMaster 1980; Wright, Sonu, and Kielhorn 1972).

g. Grab sampling and samplers.

(1) Seafloor sediments in coastal areas can show great spatial and temporal variation. The surface sediments may provide information about the energy of the environment as well as the long-term processes and movement of materials, such as sediment transport pathways, sources and sinks. Bed surface sediments are typically collected with grab samplers and then analyzed using standard laboratory procedures. These tests are described in detail in other sources (Fredette et al. 1990; Buller and McManus 1979).

(2) There are a variety of grab type samplers of different sizes and design that are used for collecting surface sediment samples (described in detail in Bouma (1969)). Most consist of a set of opposing, articulated scoop-shaped jaws that are lowered to the bottom in an open position and are then closed by various trip mechanisms to retrieve a sample. Many grab samplers are small enough to be deployed and retrieved by hand; others require some type of lifting gear. If there is gravel in the sample, at least 2 to 3 litres of sample are needed for reliable grain size distribution testing.

(3) A simple and inexpensive dredge sampler can be made of a section of pipe that is closed at one end. It is dragged a short distance across the bottom to collect a sample. Unlike grab samples, the dredged samples are not representative of a single point and may have lost finer material during recovery. However, dredge samplers are useful in areas where shells or gravel which prevent complete closure of the jaws are present.

(4) Although obtaining surficial samples is helpful for assessing recent processes, it is typically of limited value in stratigraphic study because grab samplers usually recover less than 15 cm of the sediment. Generally, the expense of running tracklines in coastal waters for the sole purpose of sampling surficial sediments is not economically justified unless particularly inexpensive boats can be used. Occasionally, grab and dredge samples are taken during geophysical surveys, but the sampling operations require the vessel to stop at each station, thus losing survey time and creating interrupted data coverage. Precise offshore positioning now allows grab samples to be collected at specific locations along the boat's track after the survey has been run and the data examined.

h. Stratigraphic sampling.

(1) Sediments and sedimentary rock sequences are a record of the history of the earth and its changing environments, including sea-level changes, paleoclimates, ocean circulation, atmospheric and ocean geochemical changes, and the history of the earth's magnetic field. By analyzing stratigraphic data, age relations of the rock strata, rock form and distribution, lithologies, fossil record, biopaleogeography, and episodes of erosion and deposition at a coastal site can be determined. Erosion removes part of the physical record, resulting in unconformities. Often, evidence of erosion can be interpreted using physical evidence or dating techniques.

(2) Sediment deposits located across a zone that ranges from the maximum water level elevation to the depth of the wave base are largely indicative of recent processes. Within this zone in unconsolidated sediments, simple reconnaissance field techniques are available for collecting data. The techniques often use ordinary construction equipment or hand tools. Smaller efforts require shovels, hand augers, posthole diggers, or similar hand-operated devices. Larger-scale efforts may include trenches, pits or other large openings created for visual inspection, sample collection, and photography (Figure 5-7). A sedimentary peel can be taken from the exposed surface. The peel retains the original



Figure 5-7. Trench excavated in the edge of a sand dune, eastern Alabama near Alabama/Florida state line

arrangement of sedimentary properties (Bouma 1969). Often, undisturbed chunk or block samples and disturbed jar or bag samples are carved from these excavations and taken back to the laboratory.

(3) Rates and patterns of sedimentation can be determined using marker horizons. Marker horizons may

occur in relation to natural events and unintentional human activities or they may be directly emplaced for the express purpose of determining rates and patterns of sedimentation. Recently, several studies have estimated rates of sedimentation in marshes by spreading feldspar markers and later measuring the thicknesses of materials deposited on the feldspar with cryogenic coring devices.

(4) The petrology and mineralogy of rock samples can be used to identify the source of the sediment. This can indicate if river flow has changed or if coastal currents have changed directions. Mineralogy as it pertains to sediment budgets is discussed in Meisburger (1993) and Wilde and Case (1977).

(5) Direct sampling of subbottom materials is often essential for stratigraphic studies that extend beyond historic time scales. Table 5-3 lists details on a number of subaqueous sediment sampling systems that do not require drill rigs. One system listed in Table 5-3, the vibracorer, is commonly used by geologists to obtain samples in the marine and coastal environment. Vibratory corers consist of three main components: a frame, coring tube or barrel, and a drive head with a vibrator (Figure 5-8). The frame consists of a quadrapod or tripod arrangement, with legs connected to a vertical beam. The beam supports and guides the core barrel and vibrator and allows the corer to be free-standing on the land surface or seafloor. The core may be up to 3 or 4 m long, which is adequate for borrow site investigations and many other coastal studies.

(6) While common vibratory corers are capable of penetrating up to 5 m or more of unconsolidated sediment, actual performance depends on the nature of the subbottom material. Under unfavorable conditions, very little sediment may be recovered. Limited recovery occurs for several reasons, chief among these being lack of penetration of the core barrel. In general, stiff clays, gravel and hard-packed fine to very fine sands are usually most difficult to penetrate. Compaction and loss of material during recovery can also cause a discrepancy between penetration and recovery. In comparison with rotary soil boring operations, vibratory coring setup, deployment, operation, and recovery are rapid. Usually a 3-m core can be obtained in a manner of minutes. Longer cores require a crane or some other means of hoisting the equipment, a procedure that consumes more time, but is still comparatively rapid. Success with vibracoring depends on some prior knowledge of sediment type in the region.

(7) Cores can be invaluable because they allow a direct, detailed examination of the layering and sequences of the subsurface sediment in the study area. The sequences provide information regarding the history of the depositional environment and the physical processes during the time of sedimentation. Depending upon the information required, the types of analysis that can be performed on the core include grain size, sedimentary structures, identification of shells and minerals, organic content, microfaunal identification, (pollen counts) x-ray

radiographs, radiometric dating, and engineering tests. If only information regarding recent processes is necessary, then a box corer, which samples up to 0.6-m depths, can provide sufficient sediment. Because of its greater width, a box corer can recover undisturbed sediment from immediately below the seafloor, allowing the examination of microstructure and lamination. These structures are usually destroyed by traditional vibratory or rotary coring.

(8) If it is necessary to obtain deep cores, or if there are cemented or very hard sediments in the subsurface, rotary coring is necessary. Truck- or skid-mounted drilling rigs can be conveniently used on beaches or on barges in lagoons and shallow water. Offshore, rotary drilling becomes more complex and expensive, usually requiring jack-up drilling barges or four-point anchored drill ships (Figure 5-9). An experienced drilling crew can sample 100 m of the subsurface in about 24 hr. Information on drilling and sampling practice is presented in EM 1110-1-1906 and Hunt (1984).

i. Sediment movement and surface forms. Of great importance in investigations of geologic history is tracing sediment movement. This includes identifying the locations of sediment sources and sinks, quantifying sediment transport rates, and discovering the pathways. Sediment transportation is influenced by grain properties such as size, shape, and density, with grain size being most important. Differential transport of coarse and fine, angular and rounded, and light and heavy grains leads to grading. Field visits to a locality are often repeated to assess temporal variability of these phenomena. Simultaneous measurements of energy processes, such as current and waves, are often required to understand the rates and mechanisms of movement.

(1) Measurement of sediment movement.

(a) The measurement of suspended and bed load sediment movement in the surf zone is an exceedingly difficult process. There are a variety of sampling devices available for measuring suspended and bed load transport in the field (Dugdale 1981; Seymour 1989), but these devices have not performed properly under some conditions or have been expensive and difficult to use. For these reasons, new sampling procedures are being developed and tested at CERC and other laboratories. Point measurements of sediment movement can be performed by two general procedures:

- Direct sampling and weighing of a quantity of material.

Table 5-3
Subaqueous Soil Sampling Without Drill Rigs and Casing

Device	Application	Description	Penetration depth	Comments
Petersen dredge	Large, relatively intact "grab" samples of seafloor.	Clam-shell type grab weighing about 1,000 lb with capacity about 0.4 ft ³	To about 4 in.	Effective in water depths to 200 ft. More with additional weight.
Harpoon-type gravity corer	Cores 1.5- to 6-in.-dia. in soft to firm soils.	Vaned weight connected to coring tube dropped directly from boat. Tube contains liners and core retainer.	To about 30 ft.	Maximum water depth depends only on weight. Undisturbed (UD) sampling possible with short, large-diameter barrels.
Free-fall gravity corer	Cores 1.5- to 6-in. dia. in soft to firm soils.	Device suspended on wire rope over vessel side at height above seafloor about 15 ft and then released.	Soft soils to about 17 ft. Firm soils to about 10 ft.	As above for harpoon type.
Piston gravity corer (Ewing gravity corer)	2.5-in. sample in soft to firm soils.	Similar to free-fall corer except that coring tube contains a piston that remains stationary on the seafloor during sampling.	Standard core barrel 10 ft; additional 10-ft sections can be added.	Can obtain high-quality UD samples.
Piggott explosive coring tube	Cores of soft to hard bottom sediments.	Similar to gravity corer. Drive weight serves as gun barrel and coring tube as projectile. When tube meets resistance of seafloor, weighted gun barrel slides over trigger mechanism to fire a cartridge. The exploding gas drives tube into bottom sediments.	Cores to 1-7/8 in. and to 10-ft lengths have been recovered in stiff to hard materials.	Has been used successfully in 20,000 ft of water.
Norwegian Geotechnical Institute gas-operated piston	Good-quality samples in soft clays.	Similar to the Osterberg piston sampler except that the piston on the sampling tube is activated by gas pressure.	About 35 ft.	
Vibracorer	High-quality samples in soft to firm sediments. Dia. 3-1/2 in.	Apparatus is set on seafloor. Air pressure from the vessel activates an air-powered mechanical vibrator to cause penetration of the tube, which contains a plastic liner to retain the core.	Length of 20 and 40 ft. Rate of penetration varies with material strength. Samples a 20-ft core in soft soils in 2 min.	Maximum water depth about 200 ft.
Box corer	Large, intact slice of seafloor.	Weighted box with closure of bottom for benthic biological sampling.	To about 1 ft.	Central part of sample is undisturbed.

(Adapted from Hunt (1984))

- Detection of the fluid flow by electro-optical or acoustic instruments deployed in the water.

(b) Two general methods are available to directly sample the sediment in suspension and in bed load. First, water can be collected in hand-held bottles or can be remotely sucked into containers with siphons or pump apparatus. The samples are then dried and weighed. The second method is to trap a representative quantity of the sediment with a mesh or screen trap through which the water is allowed to flow for a fixed time. A fundamental problem shared by both methods is the question of

whether the samples are truly representative of the sediment in transport. For example, how close to the seabed must the orifice be to sample bed load? If it is high enough to avoid moving bed forms, will it miss some of the bed load? Streamer traps made from mesh are inexpensive to build but difficult to use. The mesh must be small enough to trap most of the sediment but must allow water to flow freely. Kraus (1987) deployed streamers at Duck, NC, from stainless steel wire frames (Figure 5-10). Kraus and Dean (1987) obtained the distribution of long-shore sand transport using sediment traps. At this time, sediment traps are still research tools and are not

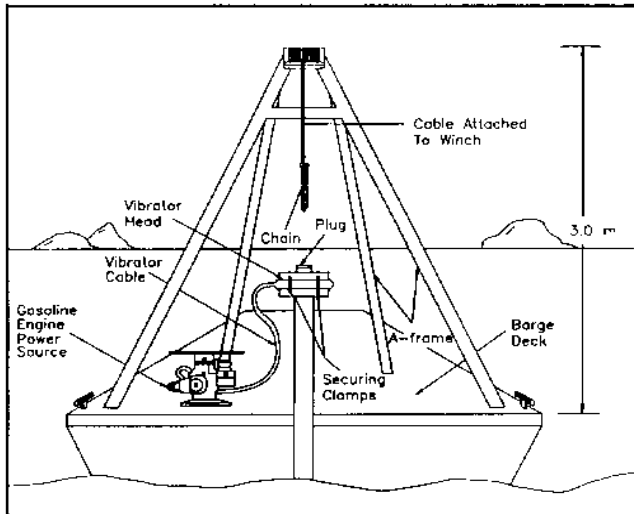

Figure 5-8. Front view of lightweight vibracorer mounted on a barge

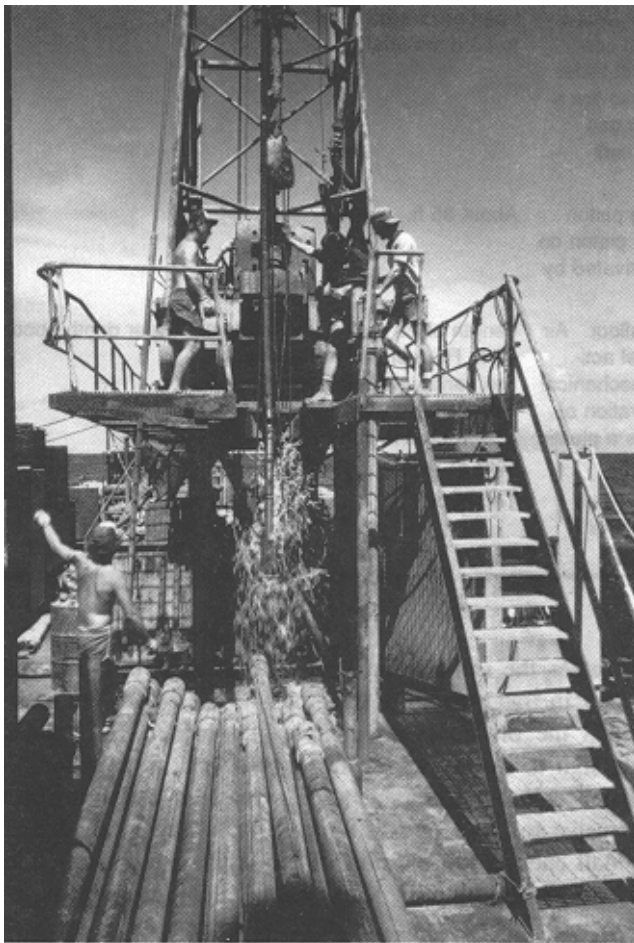

Figure 5-9. Rotary drilling operations underway from a 4-point anchored drill ship. Drilling is conducted 24 hr using two crews

commonly used. A fundamental limitation of traps is that they can usually only be used in mild conditions. In winter and during storms it is too hazardous for the field technicians to maintain the equipment. Perversely, it is under these harsher conditions when the greatest sediment movement occurs. Another fundamental problem is relating the instantaneous measured suspended and bedload transport to long-term sediment movement. Because of the extreme difficulty of conducting research in the surf zone, answers to these questions remain elusive.

(c) Electronic instruments are being developed to detect or estimate sediment transport. They have some advantages over direct sampling procedures. These include the ability to measure the temporal variations of suspended or bed load sediment and the ability to be used in cold water or in harsh conditions. (Note, however, that in severe storms, essentially no man-made devices have survived in the surf zone.) Their disadvantages include the difficulty of calibrating the sensors and testing their use with different types of sand and under different temperatures. In addition, many of these instruments are expensive and not yet commonly available. Sternberg (1989) and Seymour (1989) discuss ongoing research to develop and test new instruments for use in sediment transport studies in estuarine and coastal areas.

(d) Sediment movement, both bed load or total load, can also be measured with the use of natural and artificial tracers (Dugdale 1981). Heavy minerals are natural tracers which have been used in studies of sediment movement (McMaster 1960; Wilde and Case 1977). Natural sand can also be labelled using radioactive isotopes and fluorescent coatings (Arlman, Santema, and Svašek 1958; Duane 1970; Inman and Chamberlain 1959; Teleki 1966). Radioactive tracers are no longer used because of health and safety concerns. When fluorescent dyes are used, different colors can be used simultaneously on different size fractions to differentiate between successive experiments at one locality (Ingle 1966). Artificial grains, which have the same density and hydraulic response of natural grains, can also be used in tracer studies. Aluminum cobble has been used by Nicholls and Webber (1987) on rocky beaches in England. The aluminum rocks were located on the beaches using metal detectors. Nelson and Coakley (1974) review artificial tracer methods and concepts.

(e) As with other phenomena, the experimental design for tracer studies may be Eulerian or Lagrangian. For the time integration or Eulerian method, the tracer grains are injected at a constant rate over a given interval

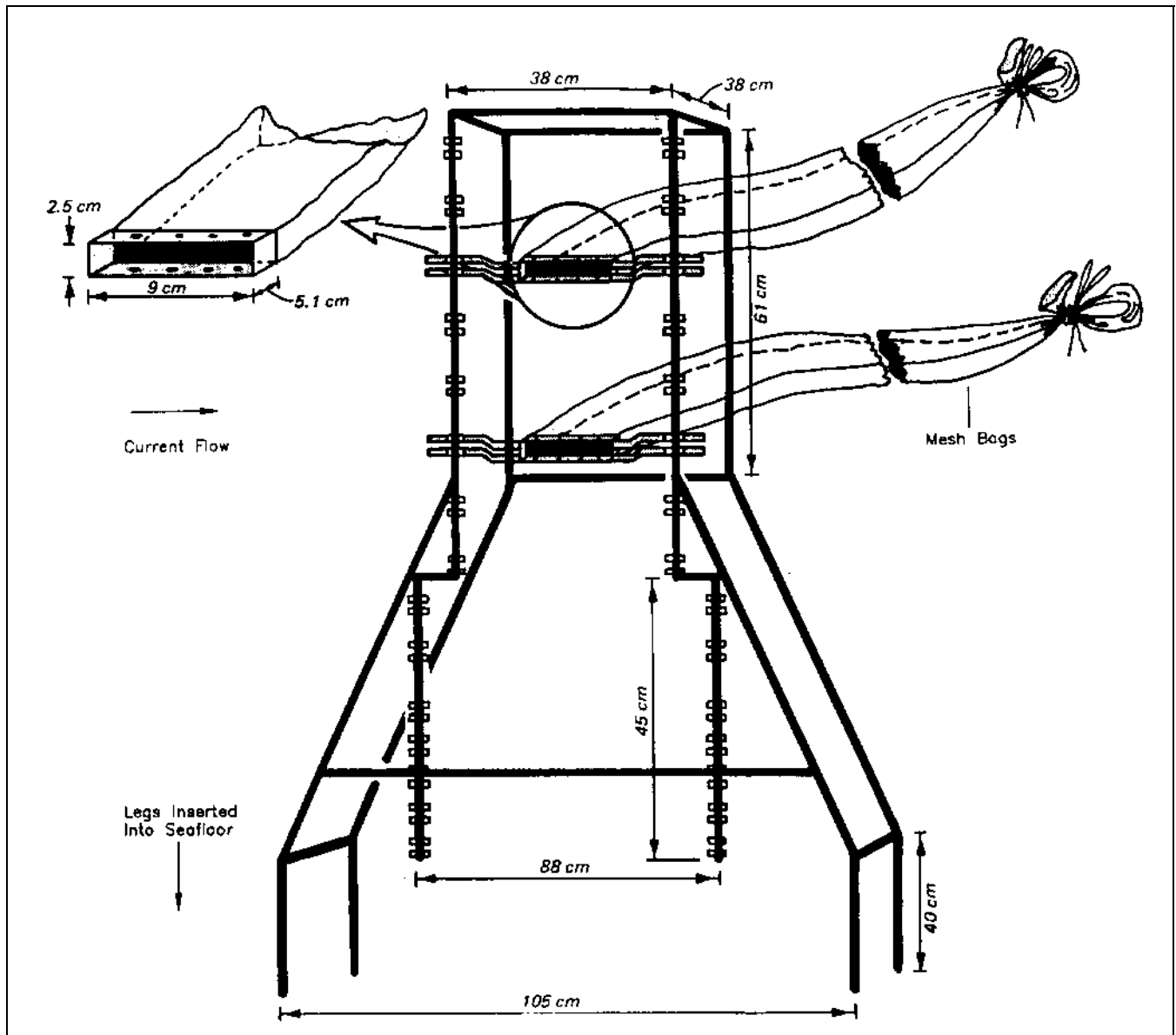

Figure 5-10. Side view of steel frame and polyester mesh sediment trap used at Duck, NC, by Kraus (1987) during CERC's DUCK-85 field experiments

of time. For the space integration or Lagrangian method, the tracers are released over an area at the same time. The choice of the method depends upon the nature of the problem. Field experiments must be designed carefully to isolate the parameter of interest that is to be measured or traced. For example, if the purpose of the study is to assess bed-load transport, then care must be taken not to introduce tracers into the suspended load in the water column.

(2) Use of subsurface structure to estimate flow regime. An introduction to bed form shape and nomenclature has been presented in Chapter 4.

(a) Several useful indices of foreset laminae, which may assist in making qualitative estimates of the strength of currents in modern and ancient sediments, are given by Jopling (1966). These include: (1) maximum angle of dip of foreset laminae (at low velocities the angle may

exceed the static angle of repose whereas at high velocities the angle is less than the static angle); (2) character of contact between foreset and bottomset (the contact changes from angular to tangential to sigmoidal with increasing velocity); (3) laminae frequency measured at right angles to bedding (there are more laminae per unit area with increasing velocity); (4) sharpness or textural contrast between adjacent laminae (at higher velocities laminae become less distinct); and (5) occurrence of regressive ripples (regressive ripples indicate relatively higher velocities).

(b) Measurements of bed forms can be accomplished on exposed sand banks at low water using surveying techniques or large-scale aerial photographs. Dimensionless parameters of ripples and other bedforms can indicate depositional environment (Tanner 1967). The flow directions can be assessed in terms of the trace of the crestline (Allen 1968). Wave-formed structures reflect the velocity and direction of the oscillatory currents as well as the length of the horizontal component of orbital motion and the presence of velocity asymmetry within the flow (Clifton and Dingler 1984). The flow strength for intertidal estuarine bed forms can also be estimated for a given flow depth by the velocity-depth sequence of bed forms (Boothroyd 1985).

j. Navigation and positioning equipment.

(1) Accurate positioning is essential for most geological monitoring studies. Several types of positioning and navigation systems are available for coastal studies, with the most common being Loran-C and Global Positioning Systems (GPS). Other technologies, such as short-range microwave and optical systems, are also in common use (Fredette et al. 1990).

(2) Loran-C computes microsecond time differences using pulsed low-frequency radio waves between networks and receivers. The differences are then computed as lines of position. The receivers can be used up to about 2,000 km from the networks with reasonable accuracy. The absolute accuracy of Loran-C varies from 180 to 450 m, while the repeatable accuracy varies from 15 to 90 m.

(3) *Global Positioning System (GPS)* is a revolution in electronic navigation for the military because of its unmatched ability to provide rapid and extremely accurate position fixes around the world under all weather conditions. The system is not yet fully operational and some of the satellites have not yet been launched. Unfortunately for civilian users, the Department of Defense has

implemented a national security program called *Selective Availability (SA)*, which deliberately degrades GPS accuracy by distorting the satellite signals. There are two types of GPS receivers:

- *Precise Positioning Systems (PPS)*, which are available only to the military and "approved civilians," contain electronic chips which recognize and correct the SA distortion.
- *Standard Positioning Systems (SPS)* are available commercially for boaters and civilians. The SA distortion makes these units accurate to 100 m 95 percent of the time and 300 m for the remaining 5 percent. The problem with SPS is that civilian users do not know the extent of the SA distortion or when it is in effect, therefore making it impossible to determine the level of accuracy of the GPS readings at any given time.

In an effort to provide accuracy of 12-20 m in harbors and harbor approaches, the U.S. Coast Guard has been developing *Differential GPS (DGPS)* for coastal waters. This procedure attempts to cancel the error which SA imposes. Using land-based receivers at specific, known locations (Coast Guard stations, lighthouses), the Coast Guard receives simultaneous signals from 12 satellites, determines the difference between the exact and GPS-reported locations, calculates a correction, and transmits the correction over local radio frequencies to nearby vessels. Boats must be equipped with special receivers to demodulate the signal and apply it to the GPS signal that the boat is receiving.

As of 1994, only 10 of the planned 47 U.S. DGPS stations have been installed, and the operating stations are still in the prototype stage. Several more years of adjusting and tuning are anticipated. Users can contact the Coast Guard's GPS Information Center (Alexandria, VA; tel 703/313 5900) for up-to-date information on the status of the system. In light of the developmental stage of DGPS technology, **users are cautioned against relying on manufacturers' claims of pinpoint accuracy.** The technology is simply not yet developed to this level. Use of GPS for USACE surveys is discussed in EM 1110-1-1003.

(4) Navigation (positioning) error standards have been established for USACE hydrographic surveys. Three general classes of surveys have been defined (EM 1110-2-1003):

- Class 1 - Contract payment surveys.
- Class 2 - Project condition surveys.
- Class 3 - Reconnaissance surveys.

Although the requirements of geologic site surveys may not be the same as those of USACE hydrographic surveys, the accuracy standards are useful criteria when specifying quality control requirements in contractual documents. The frequency of calibration is the major distinguishing factor between the classes of survey, and directly affects the accuracy and adequacy of the final results. With the increasing use of Geographic Information Systems (GIS) for analysis and manipulation of data, high standards of accuracy are imperative. Calibrations are time-consuming and reduce actual data collection time. Nevertheless, this must be countered with the economic impact that low quality data may be useless or may even lead to erroneous conclusions (leading, in turn, to incorrectly designed projects and possible litigation).

(5) The maximum allowable tolerances for each class of survey are shown in Table 5-4.

(6) Table 5-5 depicts positioning systems which are considered suitable for each class of survey. The table presumes that the typical project is located within 40 km (25 miles) of a coastline or shoreline reference point. Surveys further offshore should conform to the standards in the NOAA Hydrographic Manual (NOAA 1976). Planning and successful implementation of offshore surveys are sophisticated activities and should be carried out by personnel or contractors with considerable experience and a successful record in achieving the accuracies specified for the particular surveys.

k. Geophysical techniques.

(1) Geophysical survey techniques, involving the use of sound waves and high quality positioning systems on

ocean vessels, are widely used for gathering subsurface geological and geotechnical data in coastal environments. Geophysical procedures provide indirect subsurface data as opposed to the direct methods such as coring and trenching. The use of geophysical methods can assist in locating and correlating geologic materials and features by determining acoustic transparency, diffraction patterns, configuration and continuity of reflectors, and apparent bedding patterns. Inferences can often be made using these measures of stratigraphic and lithologic characteristics and important discontinuities. Table 5-6 lists frequencies of common geophysical tools.

(2) Fathometers or depth-sounders, side-scan sonar, and subbottom profilers are three major types of equipment used to collect geophysical data in marine exploration programs. All three systems are acoustic devices that function by propagating acoustic pulses in the water and measuring the lapsed time between pulse initiation and the arrival of return signals reflected from various features on or beneath the bottom. These systems are used to obtain information on seafloor geomorphology, bottom features such as ripple marks and rock outcrops, and the underlying rock and sediment units. Acoustic depth-sounders are used for conducting bathymetric surveys. Side-scan sonar provides an image of the aerial distribution of sediment and surface bed forms and larger features such as shoals and channels. It can thus be helpful in mapping directions of sediment motion. Subbottom profilers are used to examine the near-surface stratigraphy of features below the seafloor.

(3) A single geophysical method rarely provides enough information about subsurface conditions to be used without actual sediment samples or additional data from other geophysical methods. Each geophysical technique typically responds to several different physical characteristics of earth materials, and correlation of data from several methods provides the most meaningful results. **All geophysical methods rely heavily on experienced operators and analysts.**

Table 5-4
Maximum Allowable Errors for Hydrographic Surveys

Type of Error	Survey Classification		
	1 Contract Payment	2 Project Condition	3 Reconnaissance
Resultant two-dimensional one-sigma RMS positional error not to exceed	3 m	6 m	100 m
Resultant vertical depth measurement one-sigma standard error not to exceed	± .152 m (± 0.5 ft)	± .305 m (± 1.0 ft)	± .457 m (± 1.5 ft)

(From EM 1110-2-1003)

Table 5-5
Allowable Horizontal Positioning System Criteria

Positioning System	Estimated Positional Accuracy (meters, RMS)	Allowable for Survey Class		
		1	2	3
Visual Range Intersection	3 to 20	No	No	Yes
Sextant Angle Resection	2 to 10	No	Yes	Yes
Transit/Theodolite Angle Intersection	1 to 5	Yes	Yes	Yes
Range Azimuth Intersection	0.5 to 3	Yes	Yes	Yes
Tag Line (Static Measurements from Bank)				
< 457 m (1,500 ft) from baseline	0.3 to 1	Yes	Yes	Yes
> 457 m (1,500 ft) but < 914 m (3,000 ft)	1 to 5	No	Yes	Yes
> 914 m (3,000 ft) from baseline	5 to 50+	No	No	Yes
Tag Line (Dynamic)				
< 305 m (1,000 ft) from baseline	1 to 3	Yes	Yes	Yes
> 305 m (1,000 ft) but < 610 m (2,000 ft)	3 to 6	No	Yes	Yes
> 610 m (2,000 ft) from baseline	6 to 50+	No	No	Yes
Tag Line (Baseline Boat)	5 to 50+	No	No	Yes
High-Frequency EPS* (Microwave or UHF)	1 to 4	Yes	Yes	Yes
Medium-Frequency EPS	3 to 10	No	Yes	Yes
Low-Frequency EPS (Loran)	50 to 2000	No	No	Yes
Satellite Positioning:				
Doppler	100 to 300	No	No	No
STARFIX	5	No	Yes	Yes
NAVSTAR GPS:**				
Absolute Point Positioning (No SA)	15	No	No	Yes
Absolute Point Positioning (w/SA)	50 to 100	No	No	Yes
Differential Pseudo Ranging	2 to 5	Yes	Yes	Yes
Differential Kinematic (future)	0.1 to 1.0	Yes	Yes	Yes

* Electronic Positioning System

** Global Positioning System

(From EM 1110-2-1003)

(4) Bathymetric surveys are required for many studies of geology and geomorphology in coastal waters. Echo sounders are most often used to measure water depths offshore. Errors in acoustic depth determination are caused by several factors:

(a) Velocity of sound in water. The velocity in near-surface water is about 1,500 m/sec but varies with water density, which is a function of temperature, depth, and salinity. For high-precision surveys, the acoustic velocity should be measured onsite.

(b) Boat-specific corrections. As the survey progresses, the vessel's draft changes as fuel and water are used. Depth checks should be performed several times per day to calibrate the echo sounders.

(c) Survey vessel location with respect to known datums. An echo sounder on a boat simply measures the depth of the water as the boat moves over the seafloor. However, the boat is a platform that moves vertically depending on oceanographic conditions such as tides and surges. To obtain water depths that are referenced to a

Table 5-6
Summary of Acoustic Survey Systems

Acoustic System	Frequency (kHz)	Purpose
Sea floor and water column		
Echosounder	12 - 80	Measure water depth for bathymetric mapping
Water column bubble detector (tuned transducer)	3 - 12	Detect bubble clusters, fish, flora, debris in water column
Side-scan sonar	38 - 250	Map sea floor topography, texture, outcrops, man-made debris, structures
Sub-bottom profilers		
Tuned transducers	3.5 - 7.0	High resolution sub-bottom penetration
Electromechanical:		
Acoustipulse®	0.8 - 5.0	Bottom penetration to ~30 m
Uniboom®	0.4 - 14	15 - 30 cm resolution with 30 - 60 m penetration
Bubble Pulser	~ 0.4	Similar to Uniboom®
Sparker:		
Standard	50 - 5,000 Hz	Use in salt water (minimum 20 ‰), penetration to 1,000 m
Optically stacked	(same)	Improved horizontal resolution
Fast-firing 4 KJ & 10 KJ	(same)	Improved horizontal and vertical resolution
De-bubbled, de-reverberated	(same)	Superior resolution, gas-charged sediment detection
Multichannel digital	(same)	Computer processing to improve resolution, reduce noise

(From Sieck and Self (1977), EG&G®, Datasonics®, and other literature)

known datum, echo sounder data must be adjusted in one of two ways. First, tides can be measured at a nearby station and the echo sounder data adjusted accordingly. Second, the vertical position of the boat can be constantly surveyed with respect to a known land datum and these results added to the water depths. For a class 1 survey, either method of data correction requires meticulous attention to quality control.

(d) Waves. As the survey boat pitches up and down, the seafloor is recorded as a wavy surface. To obtain the true seafloor for the highest quality surveys, transducers and receivers are now installed on heave-compensating mounts. These allow the boat to move vertically while the instruments remain fixed. The most common means of removing the wave signal is by processing the data after the survey. Both methods are effective, although some contractors claim one method is superior to the other.

Even with the best efforts at equipment calibration and data processing, the maximum practicable achievable accuracy for nearshore depth surveys using echosounders is about ± 0.15 m (EM 1110-2-1003). The evaluation of these errors in volumetric calculations is discussed in Section 5-5. Survey lines are typically run parallel to one another, with spacing depending on the survey's purpose and the scale of the features to be examined.

(5) In geophysical surveys, the distance between the sound source and reflector is computed as velocity of sound in that medium (rock, sediment, or water) divided by one half of the two-way travel time. This measurement is converted to an equivalent depth and recorded digitally or on a strip chart.

(6) The principles of subbottom seismic profiling are fundamentally the same as those of acoustic depth sounding. Subbottom seismic devices employ a lower

frequency, higher power signal to penetrate the seafloor (Figure 5-11). Transmission of the waves through earth materials depends upon the earth material properties, such as density and composition. The signal is reflected from interfaces between sediment layers of different acoustical impedance (Sheriff 1980). Coarse sand and gravel, glacial till and highly organic sediments are often difficult to penetrate with conventional subbottom profilers, resulting in poor records with data gaps. Digital signal processing of multi-channel data can sometimes provide useful data despite poor signal penetration. Spacing and grid dimensions again depend upon the nature of the investigation and the desired resolution.

(7) Acoustic characteristics are usually related to lithology so that seismic reflection profiles can be considered roughly analogous to a geological cross section of the subbottom material. However, because of subtle changes in acoustic impedance, reflections can appear on the record where there are minor differences in the lithology of underlying and overlying material. Also,

significant lithologic differences may go unrecorded due to similarity of acoustic impedance between bounding units, minimal thickness of the units, or masking by gas (Sheriff 1980). Because of this, seismic stratigraphy should always be considered tentative until supported by direct lithologic evidence from core samples. Signal processing procedures are being developed by the USACE to analyze waveform characteristics of outgoing and reflected pulses. With appropriate field checks, the seafloor sediment type and hardness can be modeled, reducing the need for extensive coring at a project site.

In shallow coastal areas, it is common practice to use jet probing to accompany subbottom seismic surveys. This is especially important when there is a thin veneer of sand over more resistant substrate.

(8) The two most important parameters of a subbottom seismic reflection system are its vertical resolution, or the ability to differentiate closely spaced reflectors, and penetration. As the dominant frequency of

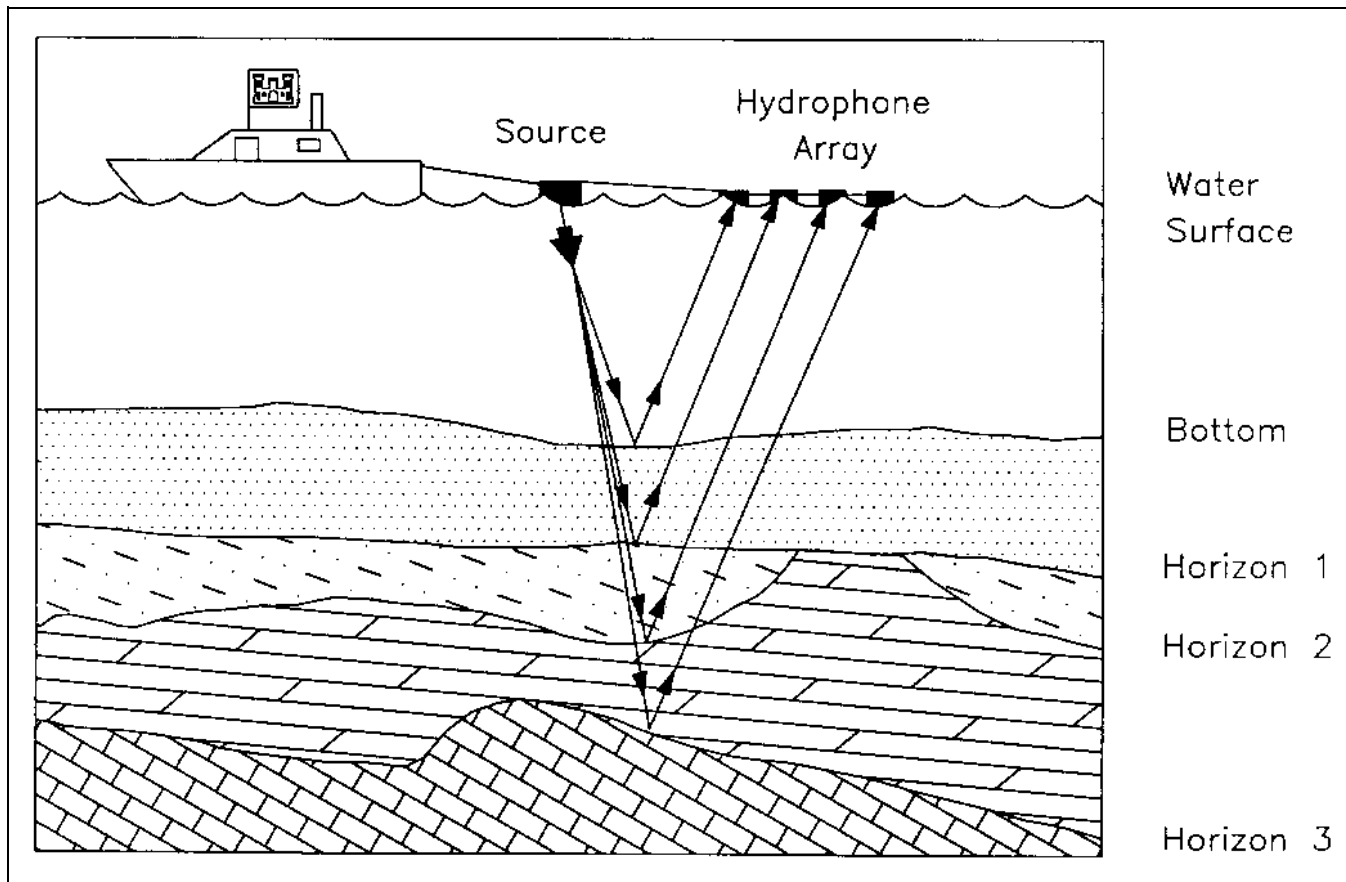

Figure 5-11. Principles of obtaining subbottom seismic data

the output signal increases, the resolution becomes finer. Unfortunately, raising the frequency of the acoustic pulses increases attenuation of the signal and consequently decreases the effective penetration. Thus, it is a common practice to use two seismic reflection systems simultaneously during a survey; one having high resolution capabilities and the other capable of greater penetration.

(9) Side-scan sonar is used to distinguish topography of the seafloor. Acoustic signals from a source towed below the water surface are directed at a low angle to either or both sides of a trackline, in contrast with the downward-directed Fathometer and seismic reflection signals (Figure 5-12). The resulting image of the bottom is similar to a continuous aerial photograph. Detailed information such as spacing and orientation of bed forms and broad differences of seafloor sediments, as well as features such as rock outcrops, boulders, bed forms, and man-made objects, can be distinguished on side-scan. It is generally recommended that bathymetry be run in conjunction with side-scan to aid in identifying objects with

subtle vertical relief. The side-scan system is sensitive to vessel motion and is most suitable for use during calm conditions.

(10) Commonly available side-scan sonar equipment, at a frequency of 100 khz, is capable of surveying the seafloor to over 500 m to either side of the vessel trackline; thus, a total swath of 1 km or more can be covered at each pass. To provide higher resolution output at close range, some systems are capable of dual operation using both 500-khz and 100-khz frequency signals. The data are simultaneously recorded on separate channels of a four-channel recorder. Digital side-scan sonar systems are available that perform signal processing to correct for slant range to seafloor targets and correct for survey vessel speed. The resulting records show the true x-y location of seafloor objects, analagous to maps or aerial photographs. The digital data can be recorded on magnetic media, allowing additional signal processing or reproduction at a later date.

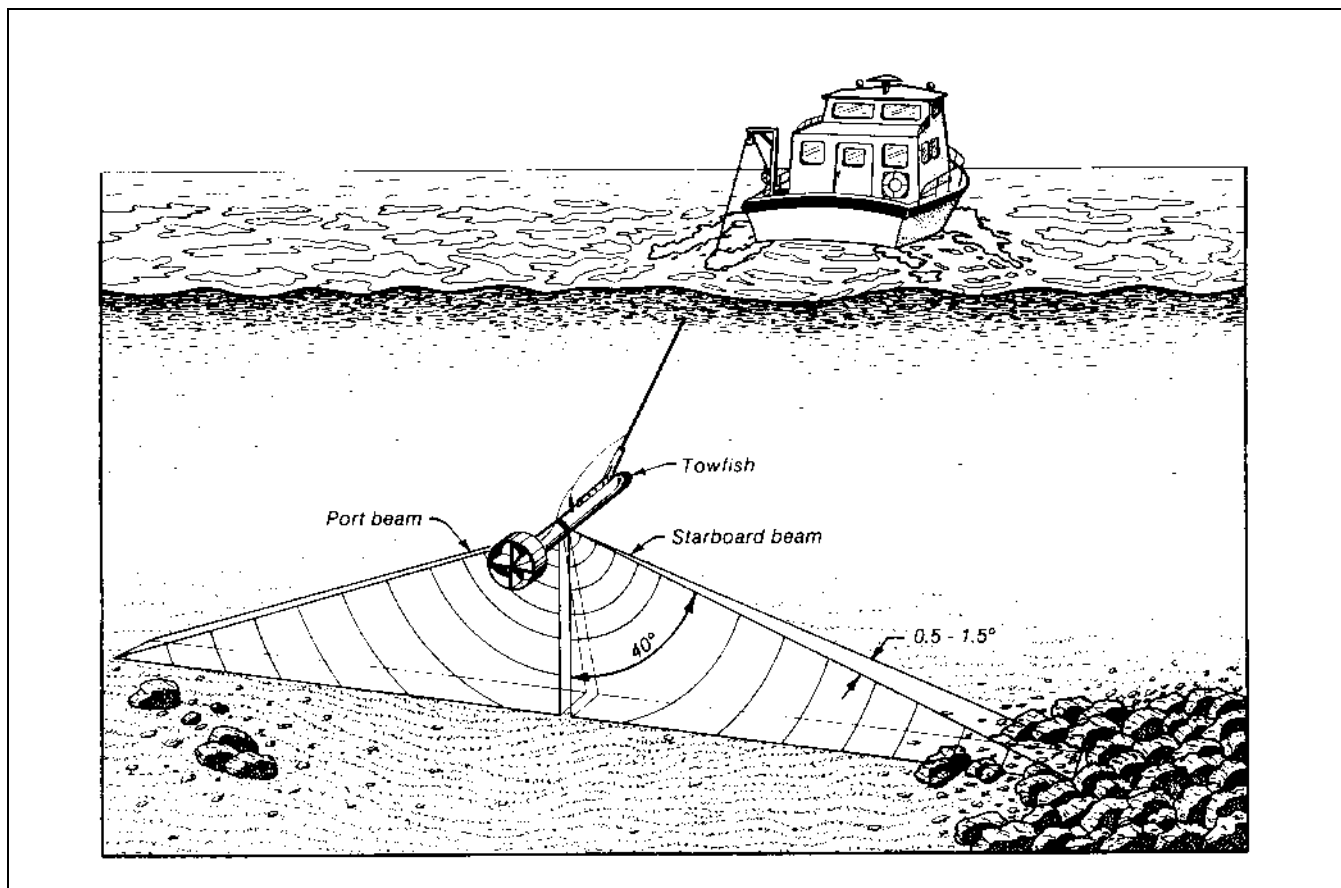

Figure 5-12. Side-scan sonar in operation

(11) The identification of potential sand borrow sites for beach renourishment has become an increasingly important economic and environmental issue in recent years. Reconnaissance surveys to identify potential sites are made using high-resolution seismic profilers, side-scan sonar, and echo sounders. Suggested survey procedures are discussed in Appendix I.

(12) Ground-penetrating radar (GPR) is a relatively new technique for subsurface exploration. In contrast to the acoustic systems described above, GPR is used sub-aerially. The radio portion of the electromagnetic spectrum is emitted from the source and reflected back to the sensors. The transparency of geologic materials varies. Sands and limestones are typically reasonably transparent. The use of GPR in marine environments is limited because salt water is non-transparent to electromagnetic radiation in the radio frequencies. Fitzgerald et al. (1992) used GPR as a tool to study beach ridge barriers in Buzzards Bay, Massachusetts. GPR has been very useful in the Great Lakes to detect buried channels and till outcrops.

1. Morphologic and bathymetric profiles.

(1) Periodic topographic and nearshore bathymetric surveys constitute the most direct and accurate means of assessing geologic and geomorphic changes over modern time scales. Time series data, such as repeated beach profiles, allow the assessment of erosion and accretion in the coastal zone. The preferred surveying technique involves collecting a series of shore-normal profile lines. These must extend landward of the zone that can be inundated by storms, usually behind the frontal dunes. The lines should extend seaward deep enough to include the portion of the shoreface where most sediment moves (i.e., to beyond closure, as defined in Chapter 4).

(2) Permanent or semi-permanent benchmarks are required for reoccupying profile sites over successive months or years. On rapidly transgressing coasts, these benchmarks should be located at the landward end of the profile line in order to minimize their likelihood of being damaged in storms. The locations of survey monuments must be carefully documented and referenced to other survey markers or control points. The ability to accurately reestablish a survey monument is very important because it ensures that profile data collected over many years will be comparable (Hemsley 1981). Locations which might experience dune burial should be avoided, and care should also be taken to reduce the visibility of benchmarks to minimize damage by vandals.

(3) Both the frequency of the sampling and the overall duration of the project must be considered when planning a beach profiling study. Morphologic changes of beaches can occur over varying time scales, and if long-term studies are to be conducted, the dynamic nature of the beach should be taken into account. Often, it is financially or logistically impractical to conduct frequent, repeated surveys for a sufficient length of time to obtain reliable and comprehensive information on long-term processes at the study area. Nonetheless, resurveying of profile lines over a period of more than one year can be of substantial help in understanding the prevailing seasonal changes. Resurveying of control profile lines at selected time intervals can reveal seasonal patterns. In addition, special surveys can be made after significant storms to determine their effects and measure the rate of recovery of the local beach system. At a minimum, summer and winter profiles are recommended. Unfortunately, there are no definitive guidelines for the timing and spacing of profile lines. Table 5-7 outlines a suggested survey schedule for monitoring beach fill projects. In summary, observation over a period of time is recommended in order to document the range of variability of morphology and bathymetry.

(4) Some issues concerning the spatial aspects of study include the spacing of profiles, longshore dimensions, and cross-shore dimensions. Profile lines should be spaced at close enough intervals to show any significant changes in lateral continuity. In a cross-shore direction, the uppermost and lowermost limits of the profiles should be located where change is unlikely to occur, and should adequately cover the most active zones such as the shore and upper shoreface. The preferred closure depth is at the toe of the shoreface, although a selected depth contour where variability becomes minimal is acceptable. Historical shorelines are an important component of where these uppermost and lowermost limits are located, particularly along rapidly changing coastlines. For example, shore and dune deposits that are now inland from the modern shoreline are likely to be affected by marine or lacustrine processes only during large storms. Large-scale aerial photographs or maps of these interior areas are usually adequate for examining these more stable features. Appropriate longshore dimensions of the survey grid depend upon the nature of the problem. Profile lines should be connected with a shore-parallel survey to determine positions and elevations of each profile relative to one another.

Table 5-7
Example of Beach Fill Area Profile Survey Scheme

Year	Times/Year	Number of Profiles
pre-fill	2	Collect within fill area and at control locations in summer and winter months to characterize seasonal profile envelope (beach & offshore).
post-fill	1	Collect all profiles immediately after fill placement at each site (beach & offshore) to document fill volume. Collect control profiles immediately after project is completed.
1	4	Four quarterly survey trips collecting all beach and offshore profiles out to depth of closure. Begin series during the quarter following the post-fill survey.
Continue year 1 schedule to time of renourishment (usually 4-6 years). If project is a single nourishment, taper surveys in subsequent years:		
2	2	6- and 12-month survey of all beach and offshore profiles
3	2	6- and 12-month survey of all beach and offshore profiles.
4	1	12-month survey of beach and offshore profiles.
Note:		
<ul style="list-style-type: none"> · If project is renourished, repeat survey schedule from post-fill immediately after each renourishment to document new fill quantity and behavior. · Project-specific morphology and process requirements may modify this scheme. · Monitoring fill after major storms is highly desirable to assess fill behavior and storm protection ability. Include both profile and sediment sampling. Conduct less than one week after storm conditions abate to document the beach and offshore response. 		

(5) Onshore (beach) profiles.

(a) Onshore portions of profiles are surveyed using standard land survey techniques and equipment. Equipment commonly used in surveys includes transits, levels, or theodolites, which are used for siting survey rods. Detailed information concerning techniques and equipment can be found in textbooks (i.e. Brinker and Wolf (1984)).

(b) Surveys are preferably conducted during low tide, when the profile line can be extended as far seaward as possible. A typical cross-shore profile survey can consist of around 25 to 50 points over a total length of 600 to 1,000 m. Data point spacing is variable, with more points taken over areas with complex elevation change such as a berm scarp or the nearshore bar trough and crest. Measurements are usually made every 5 to 10 m along the subaerial profile, or at a shorter interval to define major morphologic features. Standard procedure places the survey instrument at the baseline and proceeds seaward.

(6) Extending profile lines offshore beyond wading depths requires boats or amphibious vehicles. Amphibious vehicles are better-suited to this task because they can traverse the sea-land boundary and maintain the continuity of profile lines. Acoustic echo sounders can be used for continuous profiling seaward of the breaker zone, but the signals are usually disrupted by breaking waves, and boats

suitable for offshore use cannot approach the shore close enough to connect directly with a land profile. High-precision electronic navigation is recommended if the surveys extend offshore more than a few hundred meters.

(7) Sea sleds.

(a) During calm weather conditions, sea sleds have been successfully used to obtain shoreface profiles close to shore. A sea sled consists of a long, upright stadia rod mounted vertically on a base frame with sledlike runners (Clausner, Birkemeier, and Clark 1986) or a sled-mounted mast with a prism for use by total station survey system (Fredette et al. 1990). The sled is towed, winched, or otherwise propelled along the profile lines while frequent depth and position data are determined using onshore instruments. Because the sea sled does not float, elevations are not subject to wave or tide variations, thus providing a more accurate comparison between repeated surveys. At present, it is not possible to obtain bottom samples with a sea sled; these must be obtained from a boat or amphibious vehicle working in conjunction with the sled. Sleds are currently limited to use within 4 km of the coast and water depths of 12 m, less than the height of the sled masts. A limitation of sleds is that they normally must be used at sites with road access to the beach. It is very difficult to use them if the shore is revetted or armored. Also, sleds cannot be used if the offshore topography is rough (i.e., till or coral outcrops, glacial boulders).

(b) When conducting a sled survey, the tow boat is navigated based upon a continuous report of the sled's coordinates transmitted from the shore station. The sled should be kept to within 2 to 3 m of the shore-normal profile line 95 percent of the time. Measurements of the sled position are usually read at approximately 10-m intervals along the profile line close to shore to resolve bar/trough features, and increased to 15- to 20-m intervals further offshore (Birkemeier et al. 1985, Stauble et al. 1993). The positioning measurements are automatically recorded by a data logger and copied to a computer for processing or editing at the end of each survey day.

(8) A helicopter bathymetric surveying system has been in use at USAE District, Portland, since the 1960's. The big advantage of this procedure is that land-accuracy surveys can be conducted offshore in high waves and near structures, conditions under which a boat could not perform (Pollock 1995). A helicopter is fitted with a weighted, calibrated cable and prisms. A total station survey system is set up onshore to measure the location of the cable. Soundings are commonly taken at 8-m intervals along profile lines up to 2,500 m offshore. Operations are limited by poor visibility or winds over 15-20 m/sec (30-40 knots).

(9) The Coastal Research Amphibious Buggy (CRAB), a self-propelled vehicle, was developed to make continuous onshore-offshore profiles and obtain bottom samples. The CRAB is a tripod mounted on wheels and is propelled by hydraulic motors. It can move under its own power across the beach and shoreface to a depth of about 8 m. It has been widely used at the CERC Field Research Facility at Duck, North Carolina. Both the CRAB and sea sled are important tools for characterizing submarine bars and the overall morphology of offshore profiles (Stauble 1992).

m. Prototype monitoring.

Prototype testing and monitoring involve bringing together multiple means of investigating and measuring the processes and responses of a coastal site. Prototype studies often involve physical experiments, conducted under ideal or well-monitored conditions in the field. The purpose of many prototype studies is to test and evaluate theoretical formulae or conceptual assumptions. Prototype studies, in other instances, are conducted to assess the status and variations of environmental conditions at a site and to develop information for guidance in construction of structures.

5-4. Laboratory Techniques and Approaches

a. Laboratory observation and experiment. The characteristics of samples obtained in the field can be further analyzed in the laboratory. Some properties that are commonly examined include: (1) sediment properties, such as grain size, shape, and density, mineralogy, and heavy mineral type and content; (2) stratigraphic properties, which can be characterized using core description, preservation, and analysis techniques; and (3) geochronological history, obtained from radiometric dating and a variety of relative dating approaches. In order to achieve maximum benefit from laboratory analyses, the coastal scientist must be cognizant of the limitations and variance of precision and accuracy of each test and procedure.

(1) Laboratory analysis of sediment.

(a) Sediments can be classified into size range classes. Ranked from largest to smallest, these include boulders, cobbles, gravel, sand, silt, and clay (Table 5-8). Particle size is often expressed as D , or the diameter in millimeters, and sometimes includes a subscript, such as D_{84} , to indicate the diameter corresponding to the listed percentile. As an alternative, grain size is often expressed in phi (ϕ) units, where $\phi = -\log_2 D$ (Hobson 1979). This procedure normalizes the grain size distribution and allows computation of other size statistics based on the normal distribution.

(b) Grain-size analysis involves a series of procedures to determine the distribution of sediment sizes in a given sample. An important aspect of the laboratory analysis program, which must be designed into the field sampling scheme, is to obtain sufficient sediment to adequately determine the sediment population characteristics (Table 5-9). Large samples should be divided using a sample splitter to prevent clogging of sieves. Particle aggregates, especially those in the silt-clay range which show cohesive properties, should be separated and dispersed by gentle grinding and use of a chemical dispersant (sodium hexametaphosphate) before analysis. Note that depending on the purpose of the study, it may be important to preserve the hydraulic characteristics of sediment aggregates (i.e., clay balls, cemented sand, or shell fragments). In these circumstances, it is best to not split or mechanically grind the samples.

**Table 5-8
Sediment Particle Sizes**

ASTM (Unified) Classification ¹	U.S. Std. Sieve ²	Phi Size in mm	Phi Size	Wentworth Classification ³
Boulder	12 in (300 mm)	4096.	-12.0	Boulder
		1024.	-10.0	
Cobble	3 in (75mm)	256.	-8.0	Large Cobble
		128.	-7.0	Small Cobble
		107.64	-6.75	
		90.51	-6.5	
		76.11	-6.25	
		64.00	-6.0	
Coarse Gravel	3/4 in (19 mm)	53.82	-5.75	Very Large Pebble
		45.26	-5.5	
		38.05	-5.25	
		32.00	-5.0	Large Pebble
		26.91	-4.75	
		22.63	-4.5	
		19.03	-4.25	
		16.00	-4.0	
		13.45	-3.75	
		11.31	-3.5	Medium Pebble
Fine Gravel	2.5	9.51	-3.25	Small Pebble
		8.00	-3.0	
		6.73	-2.75	
		5.66	-2.5	
Coarse Sand	4 (4.75 mm)	4.76	-2.25	Granule
		5	-2.0	
		6	-1.75	
		7	-1.5	
		8	-1.25	
		10 (2.0 mm)	-1.0	
		12	-0.75	
		14	-0.5	
		16	-0.25	
		18	0.0	
Medium Sand	20	0.84	0.25	Coarse Sand
		25	0.5	
		30	0.75	
		35	1.0	
		40 (0.425 mm)	1.25	
		45	1.5	
		50	1.75	
		60	2.0	
		70	2.25	
		80	2.5	
Fine Sand	100	0.177	2.75	Fine Sand
		120	3.0	
		140	3.25	
		170	3.5	
		200 (0.075 mm)	3.75	
		230	4.0	
		270	4.25	
		325	4.5	
		400	4.75	
		Fine-grained Soil: Clay if $PI \geq 4$ and plot of PI vs. LL is on or above "A" line Silt if $PI < 4$ and plot of PI vs. LL is below "A" line * and the presence of organic matter does not influence LL.	300	
0.0312	5.0			Medium Silt
0.0156	6.0			Fine Silt
0.0078	7.0			Very Fine Silt
0.0039	8.0			Coarse Clay
0.00195	9.0			Medium Clay
0.00098	10.0			Fine Clay
0.00049	11.0			
0.00024	12.0			
0.00012	13.0			
0.000061	14.0			

1. ASTM Standard D 2487-92. This is the ASTM version of the Unified Soil Classification System. Both systems are similar (from ASTM (1993)).
 2. Note that British Standard, French, and German DIN mesh sizes and classifications are different.
 3. Wentworth sizes (in inches) cited in Krumbein and Sloss (1963).

Table 5-9
Minimum Weight of Sample Required for Sieving

Maximum Particle Size Present in Substantial Proportion (> 10%)		Weight of Sample
in.	mm	kg
2.5	64	50
2.0	50	35
1.5	40	15
1.0	25	5
0.75	20	2
0.50	12.5	1
0.38	10	0.5
0.25	6.3	0.2
	2.4	0.1

British Standards Institution (1975). Note: quantities specified in ASTM Standard D2487-92 are similar.

(c) Laboratory techniques used to estimate sediment diameter depend in part on the grain size. Pebbles and coarser sediments can be directly measured with calipers or by coarse sieves. The grain-size distribution of sand is determined directly by sieve analysis, sedimentation tubes, or Coulter counter. Silt and clay-sized material is determined indirectly by hydrometer or pipette analysis, or the use of a Coulter counter. The size distribution of mixed sediments is determined by using a combination of sieve and hydrometer or pipette analyses. Practical procedures for conducting laboratory grain size and mineralogical tests on sediment samples are covered by Folk (1980) and Lewis (1984). Laboratory manuals more oriented towards engineering applications include EM 1110-2-1906 and those produced by the American Society for Testing and Materials (1964) and Bowles (1986).

(d) Coastal sediments reflect the relative importance of various source areas, and transport processes. Some sources of coastal sediments include river basins that empty into the coastal zone, nearshore cliffs and uplands that are denuded by waves, wind, transported material mass wasting and slope wash, and sediments transported by longshore currents. Because gravel and larger particles require more energy to be transported, they are typically found close to their source. In contrast, silt and clay may be transported long distances. The size fraction distribution is determined by the composition of the source rocks and weathering conditions. The mineralogy of sediments, especially clays, shows that variations are controlled by source rocks and weathering conditions. Resistant minerals, such as quartz and feldspars, comprise most coastal deposits (Table 3-2). However, as tracers, the least common minerals are generally the best indicators of source.

(e) Heavy minerals can provide information regarding source and process and other aspects of geomorphic variability in the coastal zone (Brenninkmeyer 1978; Judge 1970; McMaster 1960; Neihsel 1962). Pronounced seasonal variations in heavy minerals may occur in beach and nearshore samples. Lag deposits of heavy minerals are often seen on the beach after storms.

(f) Analysis of size and texture can also be used to distinguish among sediments that may have come from the same original source area. As an example, Mason and Folk (1958) used size analysis to differentiate dune and beach sediments on Mustang Island, Texas.

(g) A variety of techniques are used to identify the mineralogy of coastal sediments. Mineralogy of coarse sediments and rocks is typically assessed using laboratory microscopes. Clay mineralogy is usually assessed with X-ray diffraction methods or electron microscopy. Heavy minerals are separated from light minerals using bromoform (specific gravity of 2.87) after washing and sieving. In unconsolidated sediments, heavy mineral samples are examined under a microscope to determine approximations or percentages of mineral types.

(2) Core description and analysis.

(a) Core description is widely used to characterize the features and depositional environments of sediments. After being collected in the field, core barrels are sealed to retain moisture. In the laboratory, they are cut in half lengthwise. One side of the core is used for description and the other for radiography, peels, and subsampling for grain size analysis, palynology, and organic materials. Cores are often photographed soon after splitting, while the exposed surfaces are still fresh.

(b) A hypothetical USACE core drilling log is shown in Figure 5-13 completed in the level of detail necessary for coastal geologic studies. An alternate sheet used at some universities is shown in Figure 5-14. Important characteristics of the sedimentary sequence that need to be described include grain size variations, sedimentary structures and directions, and occurrences of cyclic bedding, such as varves. Evidence of plant roots and features such as color changes, mottling, discontinuities, and other variations in physical characteristics may be indicators of key changes. Roots, for example, often correspond to marshes in coastal sequences. Fossils and pollen in stratigraphic sequences are indicative of paleoenvironmental characteristics and changes. Techniques for

Hole No. WC-2

DRILLING LOG		DIVISION ABC Division		INSTALLATION XYZ District		SHEET 1 OF 1 SHEETS	
1. PROJECT Warren County Beach Restoration				10. SIZE AND TYPE OF BIT None			
2. LOCATION (Coordinates or Station) X = 796,769 Y = 863,620				11. DATUM FOR ELEVATION BROWN (TBM or MSL) NGVD 1929			
3. DRILLING AGENCY GL, USAE-WES				12. MANUFACTURER'S DESIGNATION OF DRILL CERC Vibracore			
4. HOLE NO. (As shown on drawing and site number) WC-2				13. TOTAL NO. OF OVERBURDEN SAMPLES TAKEN 3		14. TOTAL NUMBER CORE BOXES 1	
5. NAME OF DRILLER R.U. Boring				15. ELEVATION GROUND WATER 0.07 m ±		16. DATE HOLE STARTED 9/24/94 COMPLETED 9/24/94	
6. DIRECTION OF HOLE <input checked="" type="checkbox"/> VERTICAL <input type="checkbox"/> INCLINED _____ DEG. FROM VERT.				17. ELEVATION TOP OF HOLE 2.35 m.			
7. THICKNESS OF OVERBURDEN 3.10 m.				18. TOTAL CORE RECOVERY FOR BORING 97 %			
8. DEPTH DRILLED INTO ROCK 0				19. SIGNATURE OF INSPECTOR Geologist: Jane Doe			
9. TOTAL DEPTH OF HOLE 3.10 m.							
ELEVATION m.	DEPTH m.	LEGEND e	CLASSIFICATION OF MATERIALS (Description) d	% CORE RECOVERY o	BOX OR SAMPLE NO. f	REMARKS (Drilling time, water loss, depth of weathering, etc., if significant) g	
2.35	0	CL	Silty Clay - Yellowish brown 10YA 3/3 with yellowish brown mottles 7.5YR 5/8. Moist, finely divided, scattered shells, very firm, many roots. Natural levee environment.			Notes: 1. Colors described as per Munsell system. 2. Depositional environment from preliminary field geologist evaluation. 3. Sample taken in 3.0" I.D. thin-wall aluminum irrigation pipe. Vibrated with vibracore to 3.1m. No retainer, no drill bit. 4. Tube pulled out by cable. 5. Hole collapsed within 1 hr. at tube removal. 6. Water line in hole at 2.28 m. depth prior to collapse. 7. Condition of core when split: v. good and complete. 8. No H ₂ S odor detected.	
1.79	.56	SP	Silty Sand - Dark grayish brown 2.5Y 4/2. Loose, moist, parallel laminations, burrows. Minimal (22%) fines. Alluvial environment.		0.6 SP1		
1.40	.75	CL	Clay - Dark yellowish brown 10YR 6/2. Very firm, moist. Gray silt and clay laminations - depth of 1.40 m.		0.8 SP2		
1.25	1.10	OL	Organic Clay - Brown to grayish brown 5YR 4/3 Very firm, moist, distinct laminations, lead casts in lower section, sparse forams, sparse pyritized roots. Tidal marsh environment.	100	1.10 SP3 Pick forams from bag sample		
0.30	2.05	PT	Peat - Dusky brown 5YR 2/2. Fibrous, firm, moist, massive Salt marsh environment		1.24 SP3		
0.07	2.28	SP	Sand - Dark grayish brown 2.5Y 4/2. Very firm, wet, distinct bedding, possible ripples and scour, scattered clay lenses. Possible barrier island or inlet ebb shoal environment.		2.0 Box # 1: 0.0-3.0m		
-0.65	3.0		LOST - Fall out of bottom of sample tube	0			
-0.75	3.1		Bottom of hole at 3.10m.				
			Additional logging in lab: Cut longitudinal thin section for X-ray of entire core, then epoxy peel entire thin section.			4. Core tube split in field. Core split longitudinally, wrapped to retain moisture, and placed in box. Identify as WC-2-94. (Bags in box also)	

ENG FORM 1836 PREVIOUS EDITIONS ARE OBSOLETE. MAR 71 PROJECT Warren Co. Beach Restor. HOLE NO. WC-2

Figure 5-13. Example of hypothetical USACE drilling log. Descriptions and notations by field geologist should be sufficiently complete to allow an interpretation of depositional environment and other factors indicating paleoenvironmental characteristics

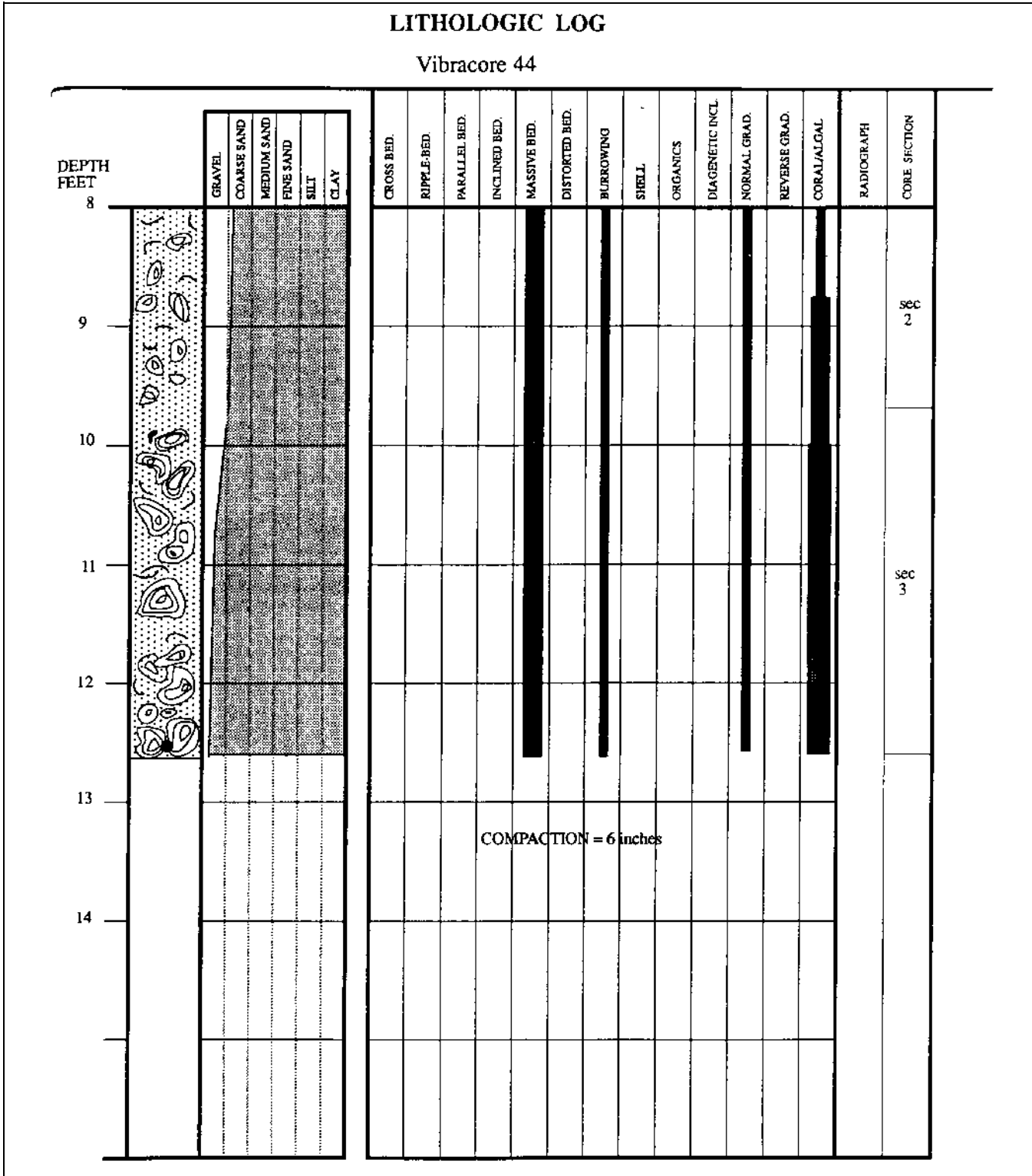

Figure 5-14. Example core description form used for sedimentary environments (courtesy of Dr. Harry Roberts, Louisiana State University)

analysis and interpretation of such evidence can be found in Faegri and Iverson (1975) and Kapp (1969).

(c) Grain size variation in cores can yield much information about the sedimentary environments and thus the geologic history of the region. Coarser fractions settle first, followed by silts and clays. This separation is a function of particle settling velocities, which vary depending upon particle size, density, shape, and the nature of the transport media. Changes in the environment of deposition can result in the clay fraction being separated from granular material both spatially and temporally. For example, silt and clay are usually deposited further from shore than granular material.

(d) X-ray radiography is an imaging method that amplifies contrasts in grain size, mineralogical composition, packing density, water content, diagenetic products, sedimentary structures and geochemical inclusions in cores that otherwise appear homogeneous (Roberts 1981). Being able to distinguish these features may assist in understanding the sequence of geomorphic changes that occurred at that site. For example, the scale and direction of bed forms can be used to estimate paleocurrents. Marker horizons are related to a date or a significant event. Peat indicates stability and growth at or near sea level. Radiography is based on the differential transmission of X-ray radiation through a sample onto sensitized X-ray photographic film. Variations in texture as well as chemical composition throughout the sediment result in differential attenuation of the incident X-ray radiation before it reaches the underlying film. Samples of uniform thickness (about 1 cm) that are cut lengthwise with a wire knife provide the best results in radiography (Roberts 1981).

(e) The occurrence of paleosols in cores may also provide important information toward assessing the geologic history of coasts. In terrestrial coastal environments, there may be prolonged periods of minimal sedimentation during which soil development may occur, followed by periods of relatively rapid sedimentation without soil development.¹ This scenario is characteristic of recent sea level changes during the Quaternary. As alternative scenarios, such cycles could occur in a semi-protected salt marsh subject to sedimentation during a severe storm or

in a soil which subsided as a result of rapid burial by other sediments. As with modern soils, horizon color and horizon assemblages based on color permit an initial identification. Important paleosols, which may reflect only limited pedogenesis, are represented only by thin, dark, organic horizons. Less apparent chemical and physical changes in sediments which were exposed to atmospheric and meteorological processes may also occur. Soils that are uniform over a wide area can sometimes be used as approximate marker horizons and thus are valuable for relative dating purposes. In some circumstances, soils may also contain enough organic material to be suitable for radiocarbon dating.

(3) Geochronology. Geochronology is the study of time in relationship to the history of the earth. Geochronology encompasses a variety of radiometric and non-radiometric techniques, which collectively can date materials whose ages extend from near-present through the Pleistocene and earlier. Radiometric techniques vary in precision, in time range, in the types of materials that can be analyzed, and the type of information that results are capable of providing. Non-radiometric techniques that may be useful in coastal areas include archives, archeology, dendrochronology, thermoluminescence dating, magnetostratigraphy or paleomagnetic dating, paleoecology, the use of weathering and coating indices. Use of multiple techniques typically provides the best results for assessing the geologic history of coasts.

(4) Radiometric dating and isotopes.

(a) Radiometric dating techniques have been used since the 1950's. Many natural elements are a mixture of several isotopes, which have the same chemical properties and atomic numbers but different numbers of neutrons and hence atomic masses. Radiometric methods of dating are based on radioactive decay of unstable isotopes. The duration of time leading to the state where half the original concentration remains is known as the half-life. In general, the useful dating range of individual isotopic methods is about ten times their half-life. The radiometric isotopes Carbon-14, Potassium-Argon 40, Caesium-137, Lead-210, and Thorium-230 are the most commonly used in standard geologic investigations (Faure 1977; Friedlander, Kennedy, and Miller 1955).

(b) Radiocarbon (Carbon-14 or ¹⁴C) dating is perhaps the most widely used technique for assessing the age of Holocene and late Pleistocene organic materials. Once an organism or plant dies, its radiocarbon (¹⁴C) content is no longer replenished and begins to decrease exponentially, achieving a half-life after some 5,730 years.

¹ The term "soil" in this context refers to unconsolidated surficial sediment which supports plant life. This is a more restrictive definition than the one typically used in engineering texts, which refers to soil as any unconsolidated material, even if barren of plant life.

Substances that are often examined with ^{14}C dating include wood, charcoal, peat, shells, bones, aqueous carbonates, rope, and soil organics. Recent developments using mass spectrometers allow detection of absolute amounts of ^{14}C content in samples as small as 5 mg. To be comparable, radiocarbon dates are adjusted to a zero age at AD 1950. Analytical error factors are given as one or two standard deviations about the mean. Other errors, associated with sample contamination, changes in atmospheric or oceanic ^{14}C content, and fractionation, are more difficult to estimate. Absolute dates of samples less than 150 years old or greater than 50,000 years old are currently considered to be ambiguous.

(c) Potassium:argon dating (Potassium-Argon-40 or K:Ar) can be applied to a wide range of intrusive and extrusive igneous rocks that contain suitable minerals. In addition to constraints on rock type, it is necessary for the sample to be unaltered by weathering or other geological processes that may allow diffusion of radiogenic argon from the sample. The occurrence of such rocks along coasts is generally restricted to regions adjacent to plate boundaries and regions of active tectonics. Potassium-argon dating of Holocene deposits is generally imprecise, with errors of ± 15 to 30 percent. Only certain minerals, particularly those with a high K and low atmospheric Ar content, are suitable for extending the K:Ar dates into the late Pleistocene. For these reasons, it has limited applications in studies of the geologic history of coasts.

(d) Fission-track dating was developed as a complementary technique to potassium:argon (K:Ar) dating. Most applications to Quaternary deposits have involved dating airfall volcanic ash or glass deposits, a field known as tephrochronology. This material usually has wide distribution and geologically speaking has infinitely narrow depositional time duration. However, it is often absent or quickly removed in many coastal settings. If present, the rapid deposition and large aerial extent of ash make it an excellent tool for correlation of rock strata, which can provide radiometric age dates. A listing of some of the important volcanic ash layers in North America, which include very recent to Pleistocene dates, can be found in Sarna-Wojcicki, Champion, and Davis (1983).

(e) Cesium-137 (^{137}Cs) is an artificial isotope, primarily produced during the atmospheric testing of nuclear weapons. These tests began in the 1940's, peaked in the early 1960's, and have declined since the advent of nuclear test ban treaties (Wise 1980). ^{137}Cs is strongly absorbed onto sediment or soil and has been used in studies of soil erosion and sediment accumulation in wetlands,

lakes, and floodplains. The timing of very recent events (post-1954) and human impacts on coastal ecosystems can be improved using such techniques.

(f) Lead-210 (^{210}Pb) is an unstable, naturally occurring isotope with a half-life of just over 22 years and a dating range of 100 to 200 years (Oldfield and Appleby 1984, Wise 1980). It forms as part of a decay chain from Radium-226, which escapes into the atmosphere as the inert gas Radon-222. The excess or unsupported ^{210}Pb returns to the earth as rainfall or dry fallout, and can be separated from that produced by in situ decay. Applications in coastal environments are limited but show good potential. This technique would be of greatest value in low-energy environments and would allow documentation of the timing of recent events and human impacts on coastal ecosystems.

(g) Thorium-230/Uranium-234 ($^{230}\text{Th}/^{234}\text{U}$), a useful dating technique that complements other methods, is applicable for dating coral sediments. The technique involves comparing the relative amounts of the radioactive isotope of thorium, ^{230}Th , with that of uranium, ^{234}U . Thorium-230 increases in coral carbonate from zero at the death of the organism to an equilibrium with Uranium-234 at 0.5 million years, allowing samples as old as middle Pleistocene to be dated.

(5) Non-radiometric methods of dating and relative dating.

(a) Archival and archeological documentation can assist in understanding the geologic history of coasts. Historical and social documents may contain detailed descriptions of major storms, of ice movements, of shoreline changes, and of other catastrophic events. Historical records are most useful if they correspond to a particular date or specified range of time, as do newspaper reports. Archeological evidence can provide important clues for assessing Holocene environmental changes. Pottery, stone tools, coins, and other artifacts can be assigned ages and thus may be of assistance in dating surface and subsurface deposits. If discovered in a stratigraphic sequence, cultural artifacts provide a minimum age for deposits beneath and maximum age for deposits above. Archeological evidence, such as buried middens, inland ports, or submerged buildings, may also indicate shoreline changes and sometimes can be used to estimate rates of deposition in coastal areas. For example, the Holocene Mississippi River deltaic chronology was revised using artifacts as indicators of the age of the deltaic surfaces (McIntire 1958).

(b) Thermoluminescence (TL), a technique that is commonly practiced in archeology for dating pottery, has been extended for use in geological studies. It has been used for dating a variety of Pleistocene sediments, including loess. For geological purposes, TL needs further refinement because most results to date are considered in error, generally being too young. It does, however, generally provide a good estimate of stratigraphic order. Thermoluminescence dating has the best potential where clay-fired artifacts are present and has promise for dating a variety of deposits of Quaternary age.

(c) Magnetostratigraphy or paleomagnetic dating is a geochronologic technique that is used in conjunction with correlations of regional radiometric dates and paleomagnetic characteristics. Because the earth's magnetic field changes constantly, the magnetic characteristics of rock and sediments can be used to determine an age for materials. The most dramatic changes are reversals, in which the earth's polarity switches from the north to the south pole. The reversals are relatively infrequent occurrences, with the most recent one occurring 700,000 years ago. Less dramatic secular variations of the geomagnetic field, however, can also be important in helping to provide a time scale useful for dating over hundreds or thousands of years by linking magnetic properties with time scales established by radiometric techniques. The combination of declination (the angle between true and magnetic north), inclination (the dip of the earth's magnetic field), and magnetic intensity produces a characteristic paleomagnetic signature for a particular location and time. The magnetic alignments can be incorporated and preserved in baked materials, in sediment particles which settle out in standing water, and in cooled magma. The technique is most-suited to lake sediments containing homogeneous particle sizes and organics. This technique can be used in places where the magnetostratigraphy has been linked with radiometric dates and can be extended to over 200 million years before present.

(d) Dendrochronology or tree ring dating can provide precise data regarding minimum age of a geomorphic surface. It can also provide proxy data concerning environmental stresses, including climatic conditions such as cold temperatures and droughts. In some parts of the world, overlapping sets of rings on trees have been used to construct a comprehensive environmental history of the region.

(e) Lichenometry is the study of the establishment and development of lichen to determine a relative chronology (Worsley 1981). Although used most extensively

for studies of glacier fluctuations, this technique also has application in shoreline dating. The method involves the measurement of thallus size, with increasing diameter representing increasing age. It is valid from about ten years to a few centuries before present. This measurement is often conducted in the field with a ruler or with calipers. Field techniques differ, although normally the largest diameters are measured. Although there has been a lack of critical assessment of the technique, the majority of research shows that the technique gives reasonable dates when applied to a variety of environments.

(f) Paleocology is the study of fossil organisms in order to reconstruct past environments. Pollen analysis, or palynology, is the single most important branch of paleocology for the late Pleistocene and Holocene. Uses of paleocological tools include: (a) the establishment of relative chronologies and indirect dating by means of correlation with other dated sequences; (b) characterization of depositional environments at or near the sampling site, since certain species and combinations of species are adapted to certain conditions; (c) reconstruction of the paleoenvironmental and paleoclimatic conditions; (d) establishment of human-induced transformations of the vegetation and land use regime (Oldfield 1981).

(g) The use of weathering and coating indices for relative age dating in geomorphology is rapidly increasing. Using laboratory microscopes, samples are calibrated with those of known age and similar chemistry for each geographic area. One such method, obsidian hydration dating, is based on the reaction of the surface of obsidian with water from the air or soil, which produces a rind whose thickness increases with time (Pierce, Obradovich, and Friedman 1976). Rock varnish-cation ratio dating is used primarily in deserts, where rocks develop a coating (Dorn 1983). Emery (1941) used dated graffiti to determine the rates of erosion and weathering in sandstone cliffs.

(h) Varve chronology may be useful in quiescent or low-energy basins where thin laminae of clay and silt are deposited. In glaciated coastal areas, the thin layers or varves are usually annual deposits. The sequences of successive graded layers can be discerned visually. Color variations occur because usually the winter season deposits have a higher organic material content. The result is alternating light-colored, gray-brown sediment layers and dark-colored organic layers.¹ Varve chronology rarely extends beyond about 7,000 years.

¹ In freshwater lakes, varves are caused by clay-silt deposition cycles. The silt settles out in spring and summer, and the clay in fall and winter.

(i) A major limitation of varve chronology is the fact that in the marine environment, annual varves are usually only preserved in anoxic basins, where a lack of oxygen causes a dearth of bottom-dwelling animals. Otherwise, mollusks, worms, fish, and crustaceans thoroughly rework the seafloor. This reworking, known as bioturbation, thoroughly destroys near-surface microstructure in most of the shallow-water portions of the world's oceans. Examples of anoxic basins include portions of the Black Sea (Anderson, Lyons, and Cowie 1994) and Saanich Inlet in British Columbia. The latter receives an annual input of clays from the Fraser River. Yearly variations in the discharge of the Fraser River's spring freshet cause changes in varve thicknesses.

b. Physical models.

(1) The use of physical models can be invaluable in understanding how geomorphic variability occurs in coastal areas. Physical modelling provides an opportunity for reducing the complexity of natural systems, for scaling down dimensions, and for accelerating change over time so that detailed interactions can be identified. Physical models can be applied in studies of hydrodynamics, sediments, and structures. In studies of coastal processes and responses, the wave tank is both the simplest and the most utilized physical model.

(2) Physical models are typically either two- or three-dimensional. A wave tank is considered to be a two-dimensional model because changes over length and over depth can be examined. Where variations over width are also investigated, the model is considered to be three-dimensional. A three-dimensional model or basin may have a variety of types of bottoms, including beds that are fixed, fixed with tracers, or moveable. Physical models require precise scaling and calibration, and much design and construction expertise must be devoted to their initial construction. Once set up, however, they allow for direct measurement of process elements, repeated experiments over a variety of conditions, and the study and isolation of variables that are difficult to assess in the field.

(3) Some examples of physical model experiments (conducted principally in wave tanks) that helped elucidate geomorphologic variability of coasts include studies of littoral drift blockage by jetties (Seabergh and McCoy 1982), breaker type classification (Galvin 1968), experiments of cliff erosion (Sunamura 1983), relationships of storm surge or short-term water level changes to beach and dune erosion, and studies of suspended sediment concentration under waves (Hughes 1988).

(4) Large-scale physical models of harbors, rivers, and estuaries have been built and tested at the Waterways Experiment Station in order to examine the effects of jetties, weirs, channel relocations, and harbor construction on hydrodynamics and shoreline changes in these complex systems. Measurements made by gauges at prototype (i.e. field) sites have sometimes been used to help calibrate the physical models. In turn, the results of tests run in the physical models have identified locations where gauges needed to be placed in the field to measure unusual conditions. An example is provided by the Los Angeles/Long Beach Harbor model (Figure 5-15). In operation since the early 1970's, it has been used to predict the effects of harbor construction on hydrodynamics and water quality. As part of this project, wave gauges were deployed in the two harbors at selected sites. Figure 5-16 is an example of wave data from Long Beach Harbor. Although the two gauge stations were only a few hundred meters apart, the instrument at sta 2 occasionally measured unusually high energy compared to sta 1. The cause of these energy events is unknown but is hypothesized to be related to long-period harbor oscillations. The lesson is that a user must discard data without considering the siting of the instruments.

5-5. Analysis and Interpretation of Coastal Data

a. Background.

(1) All geologic and engineering project data, whether obtained from existing sources, field prototype collection, laboratory analyses, or physical models, must be analyzed and interpreted to ultimately be useful in geologic and geomorphic studies. The analysis procedures depend upon the type of data collected. Some analyses require subjectivity or interpolation, such as constructing geologic cross sections or making seismic interpretations. Others are highly objective involving computer probabilistic models. A coastal scientist or engineer should be aware of the assumptions, limitations, and errors involved, and should attempt to provide sufficient information so that his data can be replicated, analyses tested, and the interpretation supported.

(2) Computers play an important role in analysis and interpretation of data from various sources. Statistical techniques are applied to a variety of data, including: (a) spectral analysis of wave characteristics; (b) wave refraction analysis; (c) time series analysis of water level data; (d) Fourier analysis of current data; (e) moment measures of grain size; (f) eigenvectors of shoreline change; and (g) the use of fractals in shoreline geometry.

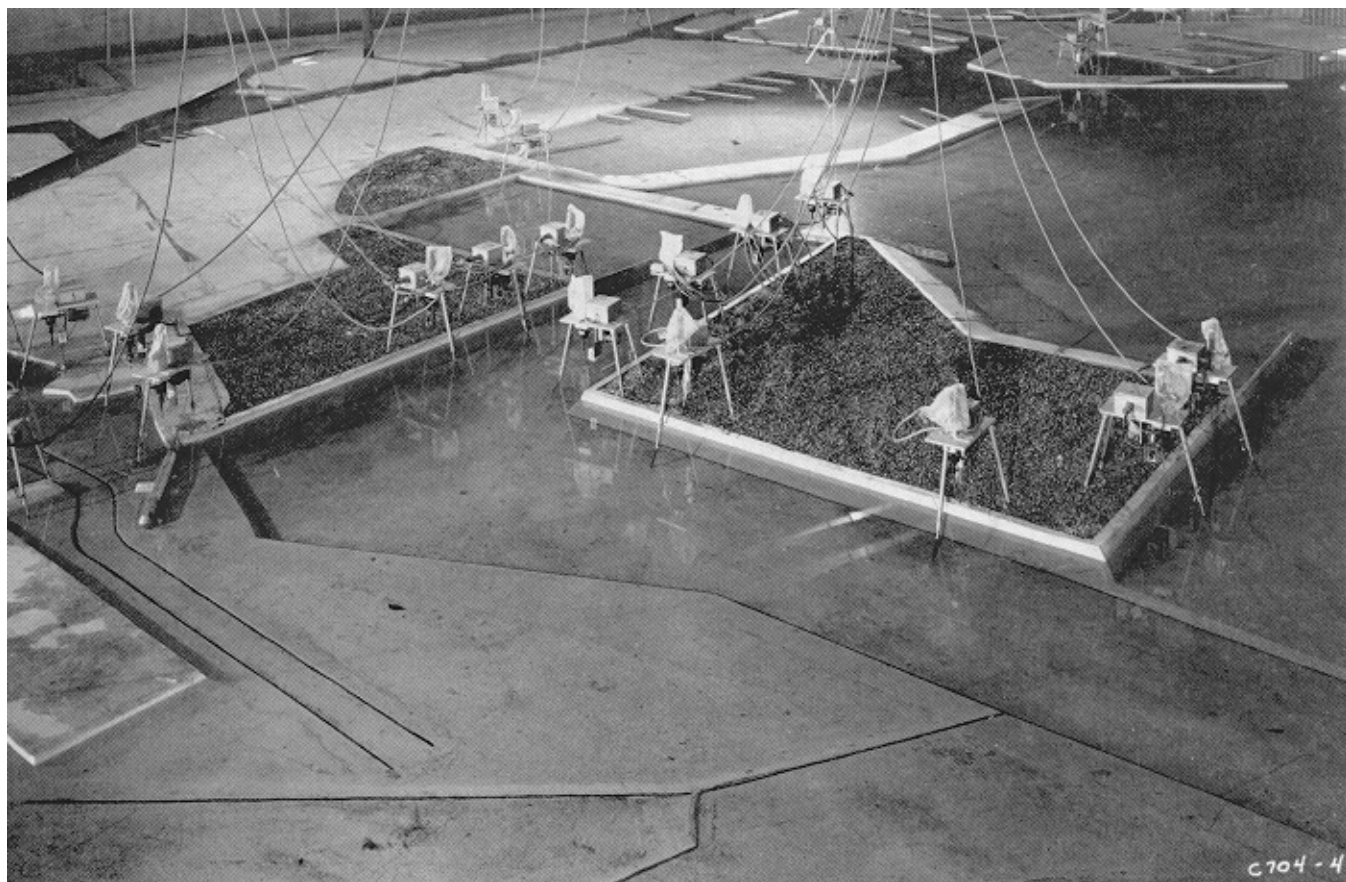

Figure 5-15. Physical model of Los Angeles/Long Beach Harbor. Instruments on tripods are water level gauges

Computers are also used for numerous types of calculations, such as volumetric changes in beach profiles, as well as two- and three-dimensional plotting of these changes. If numerous types of spatial data exist for a location, they may be entered into a Geographic Information System (GIS) so that important questions can be addressed involving spatial changes. Computer software and hardware are also used for analysis, classification, and interpretation of digital remotely sensed data from satellites and aircraft.

(3) The following sections briefly outline some concepts and procedures pertinent to analyses of coastal data. The reader is referred to specialized texts for detailed descriptions of the underlying mathematics and data processing methods.

b. Wave records.

(1) General procedures.

(a) To an observer on the shore or on a boat, the sea surface usually appears as a chaotic jumble of waves of various heights and periods, moving in many different directions. Wave gauges measure and record the changing elevation of the water surface. Unfortunately, these data, when simply plotted against time, reflect the complexities of the sea's surface and provide little initial information about the characteristics of the individual waves which were present at the time the record was being made (Figure 5-17). Once the water elevation data are acquired, further processing is necessary in order to obtain wave statistics that can be used by coastal scientists or engineers to infer what wave forces have influenced their study area.

(b) Wave data analysis typically consists of a series of steps:

- Data transfer from gauge to computer.

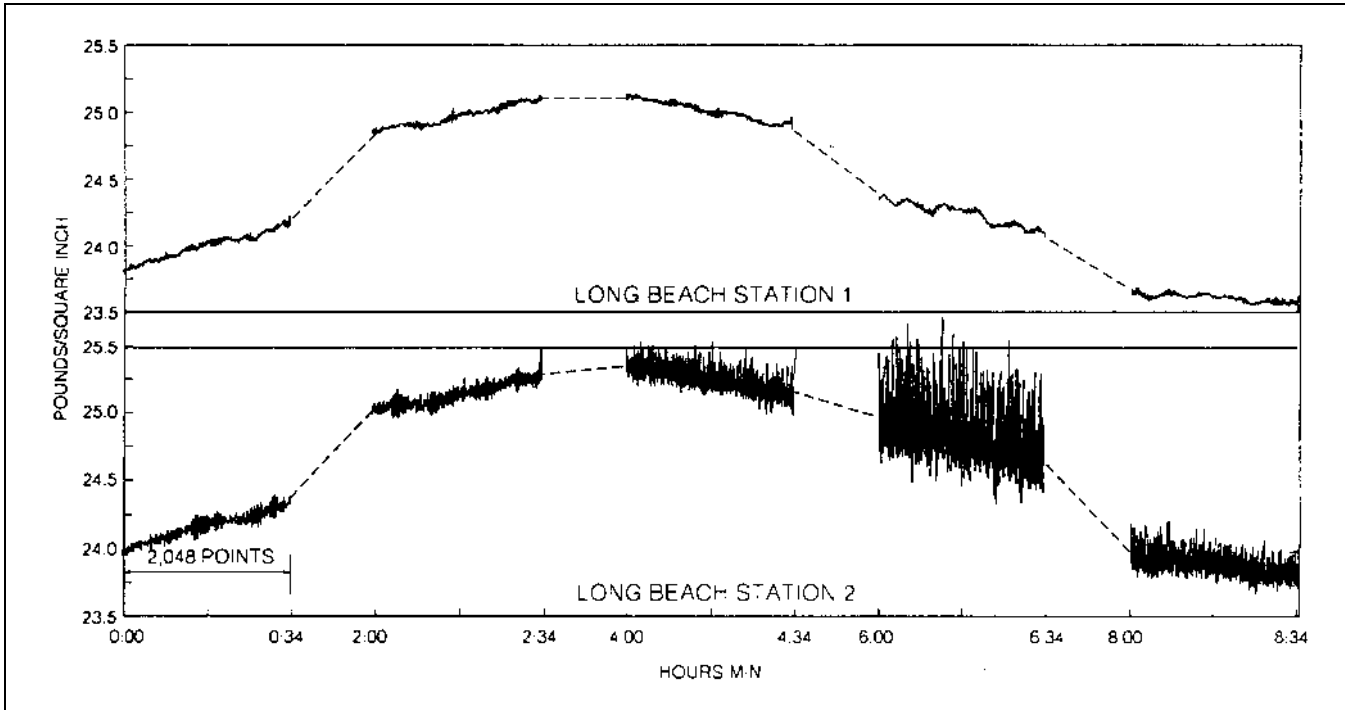

Figure 5-16. Comparison of wave gauge pressure measurements recorded at Long Beach Harbor sta 1 and 2. Although the two stations were only a few hundred meters apart, unusual energy events were recorded at sta 2 which did not appear at sta 1. The abrupt shifts in the curve at each 2-hr interval represent changes in tide height. Each 2048-point record is 34.13 min long and each new wave burst is recorded at a 2-hr interval

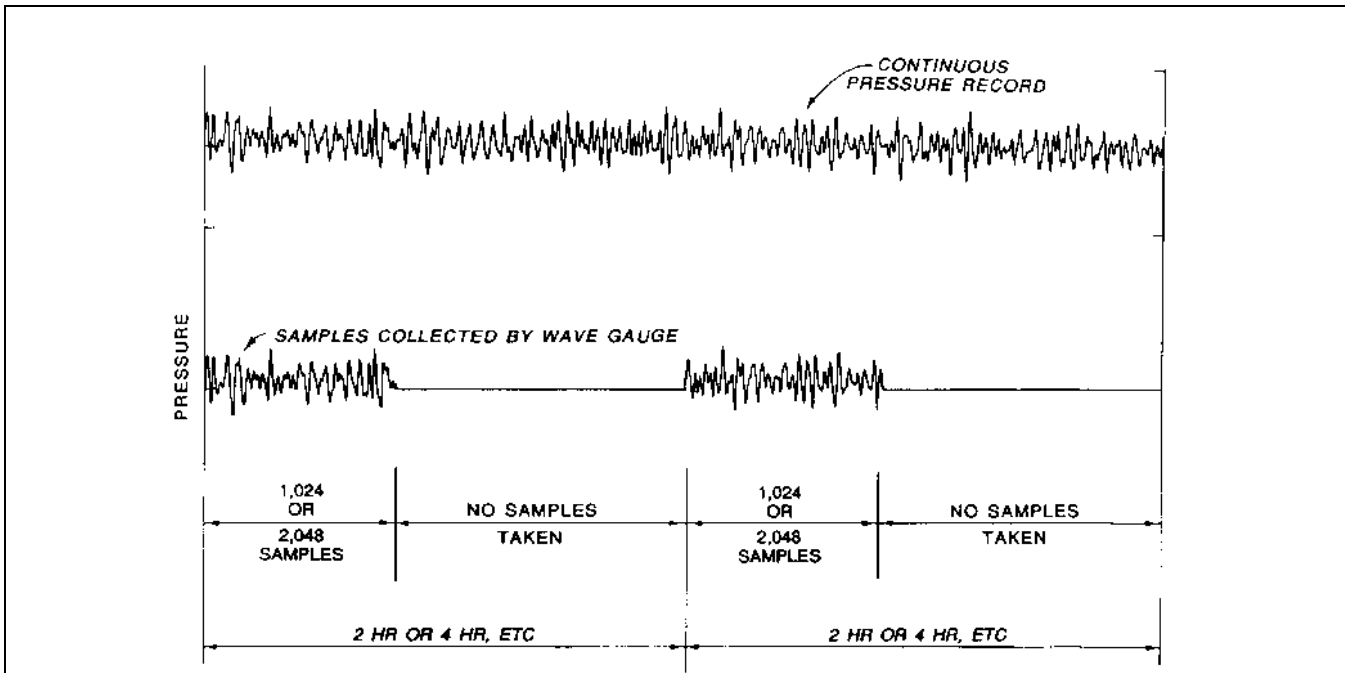

Figure 5-17. Example of continuous wave pressure record and wave burst sampling of pressure data

- Conversion of data from voltage readings to engineering units.
- Initial quality control inspection.
- Spectral analysis.
- Additional quality control (if necessary).
- Summary statistics in table and plot form.
- Plots of individual wave bursts or special processing.

It is beyond the scope of this manual to discuss details of the above procedures. This section will summarize some aspects of data collection, quality control, analysis, and terminology. Because of the complexity of the subject, the reader is referred to Bendat and Piersol (1986), Horikawa (1988), and Weaver (1983) for additional references.

(2) Data collection planning.

A continuous time series of raw pressure values plotted with time along the x-axis is shown in Figure 5-17. Because it is impractical and too expensive to collect data continuously throughout the day, discrete time series or "bursts" are collected at predetermined intervals (often every 2, 4, or 6 hr; Figure 5-17). Wave bursts typically consist of 1,024 or 2,048 consecutive pressure, U-velocity, and V-velocity¹ samples. At a sampling frequency of 1 Hz, these produce time series of 17.07 min and 34.13 min, respectively. Clearly, it would be desirable to acquire wave bursts frequently, but the sheer amount of data would soon overwhelm an analyst's ability to organize, interpret, and store the records. A researcher who plans a data acquisition program must balance the need to collect data frequently versus the need to maintain gauges in the field for an extended period. There is a temptation to assume that as long as the gauges are at sea, they should be programmed to collect absolutely as much data as possible. However, data management, analysis, and archiving can cost at least as much as the deployment and maintenance of the gauges. It is essential that these analysis costs be factored into the project budget. Typical sampling schemes used at CERC projects are listed in Table 5-10.

(3) Quality control of wave data.

Table 5-10
Wave Data Sampling Intervals, Typical CERC Projects

Instrument	Location	Sample interval hr
Sea Data self-contained wave gauge	Ocean coastlines	4 or 6
Sea Data self-contained wave gauge	Great lakes	2 or 3
CERC Directional Wave Gauge	Ocean coastlines	1
NOAA wave and meteorology buoys	Oceans and lakes	1

(a) One aspect of wave analysis, which is absolutely critical to the validity of the overall results, is the quality control procedures used to ensure that the raw data collected by the gauges are truly representative of the wave climate at the site. Wave gauges are subject to mechanical and electrical failures. The pressure sensors may be plugged or may be covered with growths while underwater. Nevertheless, even while malfunctioning, gauges may continue to collect data which, on cursory examination, may appear to be reasonable. As an example, Figure 5-18 shows pressure records from two instruments mounted on the same tripod off the mouth of Mobile Bay, Alabama. The upper record in the figure is from a gauge with a plugged pressure orifice. The curve reflects the overall change in water level caused by the tide, but high frequency fluctuations caused by the passing of waves have been severely damped. The damping is more obvious when a single wave burst of 1,024 points is plotted (Figure 5-19). Without the record from the second gauge, would an analyst have been able to conclude that the first instrument was not performing properly? This type of determination can be especially problematic in a low-energy environment like the Gulf of Mexico, where calm weather can occur for long periods.

(b) Another difficult condition to diagnose occurs when the wave energy fluctuates rapidly. Many computerized analysis procedures contain user-specified thresholds to reject records that contain too many noise spikes. Occasionally, however, violent increases in energy do occur over a short time, and it is important that the analysis procedures do not reject these records without verification. As an example, one of two gauges in Long Beach harbor (the lower curve in Figure 5-16) may have malfunctioned and written many noise spikes on the tape. In reality, the gauge recorded unusual energy events within the harbor. Another example, from Burns Harbor, Indiana, is shown in Figure 5-20. When wave height was plotted against time, numerous spikes appeared. In this

¹ Orthogonal horizontal water velocity measurements.

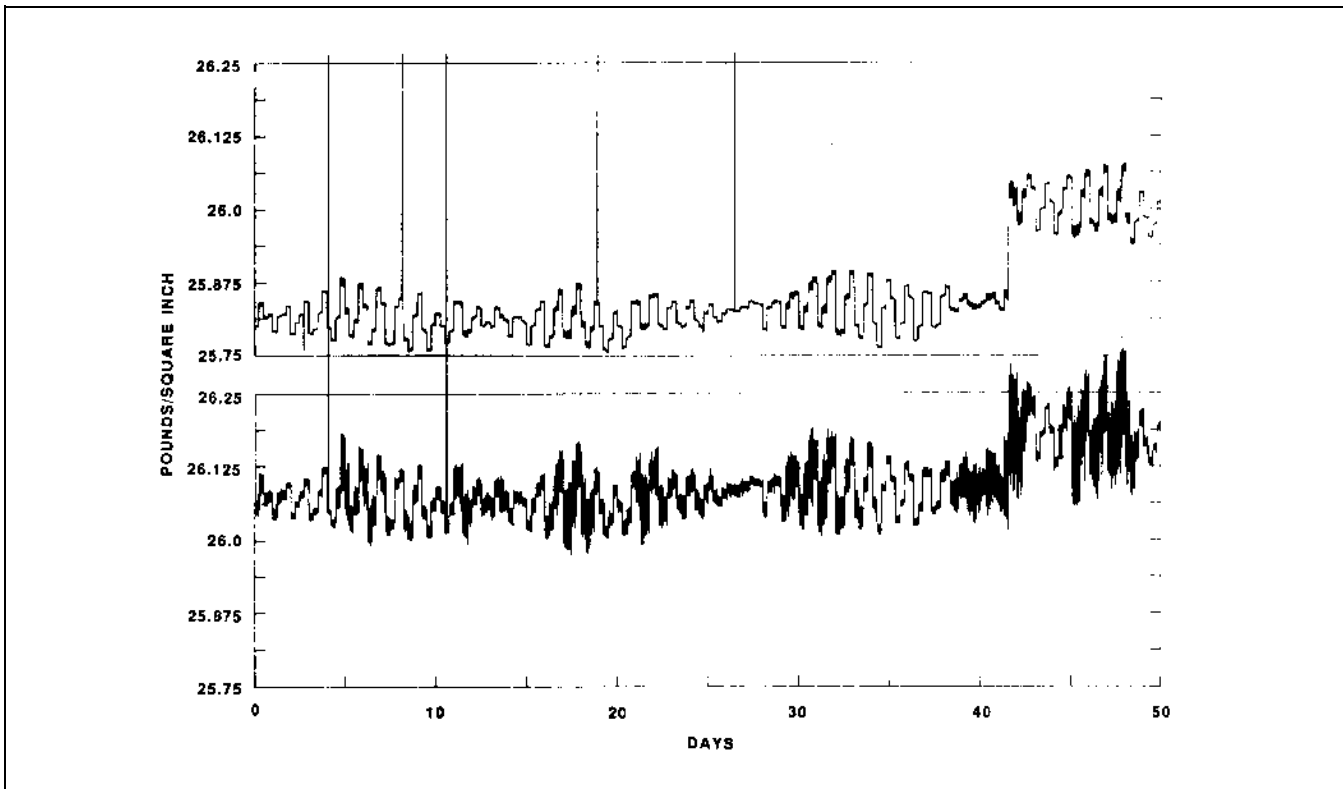

Figure 5-18. Pressure data collected by two gauges mounted on a tripod off Mobile Bay, Alabama. The upper record is from a gauge with a plugged pressure orifice. The abrupt increase in pressures near day 43 was caused when a fishing boat struck and overturned the tripod

case, the rapid increase in energy was genuine, and the spikey appearance was caused by the plotting of many weeks of data on one plot. An examination of the individual pressure records (Figure 5-21) reveals how rapidly the energy increased in only a few hours (a characteristic of Great Lakes storms). This example demonstrates that the method of displaying wave statistics can have a major influence on the way the data are perceived by an analyst. Additional examples and quality control procedures for validating wave data are discussed in Morang (1990).

(4) Analysis procedures and terminology.

(a) Wave data analysis can be broadly subdivided into non-directional and directional procedures. Although the latter are considerably more complex, the importance of delineating wave direction in coastal areas is usually great enough to justify the extra cost and complexity of trying to obtain directional wave spectra. The types of wave statistics needed vary depending on the application. For example, a geologist might want to know what the average wave period, height, and peak direction are along a stretch of the shoreline. This information could then be used to estimate wave refraction and longshore drift. An

engineer who is building a structure along the shore would be interested in the height, period, and approach direction of storm waves. He would use these values to calculate stone size for his structure. Table 5-11 lists common statistical wave parameters.

(b) Table 5-11 is intended to underscore that wave analysis is a complex procedure and should be undertaken by coastal researchers with knowledge of wave mechanics and oceanography. In addition, researchers are urged to be cautious of wave statistics from secondary sources and to be aware of how terms have been defined and statistics calculated. For example, "significant wave height" is defined as the average height of the highest one-third of the waves in a record. How long should this record be? Are the waves measured in the time domain by counting the wave upcrossings or downcrossings? The two methods may not produce the same value of H_s . Might it not be better to estimate significant wave height by performing spectral analysis of a wave time series in the frequency domain and equating $H_s = H_{m0}$? This is the procedure commonly used in experiments where large amounts of data are processed. The latter equivalency is

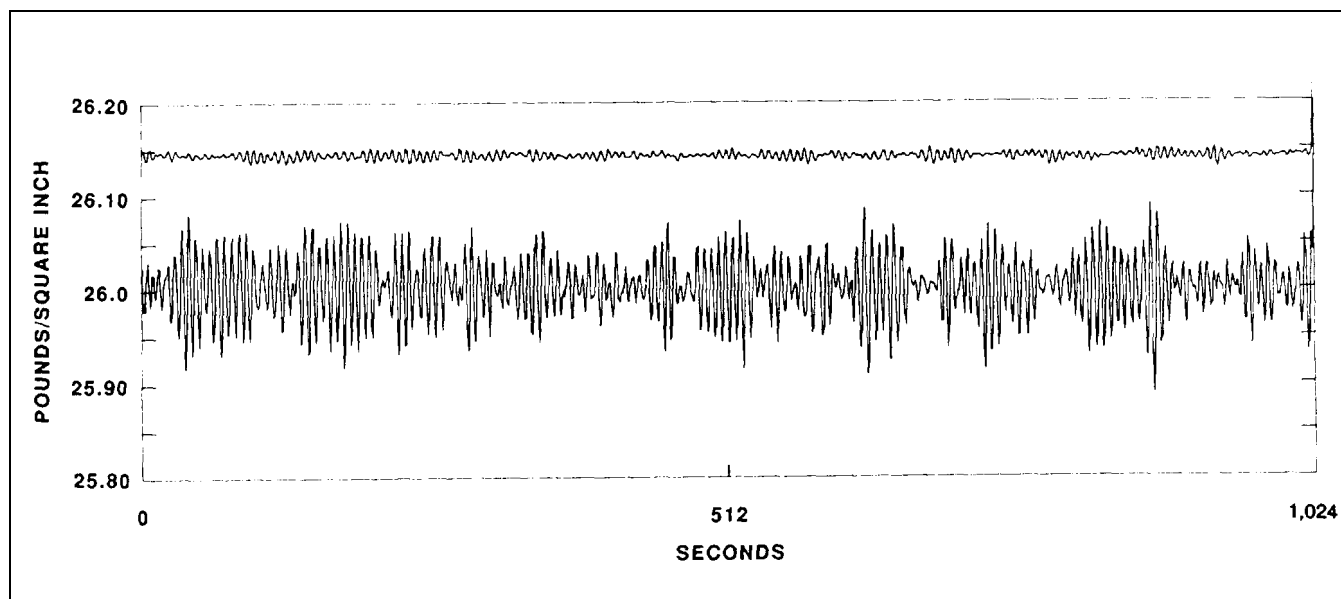

Figure 5-19. Example of a single wave burst of 1,024 pressure points from the same gauges which produced the records in Figure 5-18. The data from the plugged gauge (the upper curve) is not only reduced in amplitude but also shifted in phase. It is essentially impossible to correct the plugged data and recreate even an approximation of the original

usually considered valid in deep and intermediate water but may not be satisfactory in shallow water (Horikawa 1988).

(c) Directional wave statistics are also subject to misinterpretations depending upon the computation method. At sea, very rarely do the waves come from only one direction. More typically, swell, generated by distant storms, may approach from one or more directions, while the local wind waves may have a totally different orientation. Researchers need to distinguish how the wave energy is distributed with respect to both direction and period (i.e., the directional spectral density, $S(f, \Theta)$). The directional distribution of wave energy is often computed by a method developed by Longuet-Higgins, Cartwright, and Smith (1963) for use with floating buoys in deep water. Other distribution functions have been proposed and used by various researchers since the 1970's (Horikawa 1988). Although the various methods do not produce the same directional wave statistics under some circumstances, it is not possible to state that one method is superior to another.

(d) The user of environmental data must be aware of the convention used to report directions. Table 5-12 lists the definitions used at CERC; other institutions may not conform to these standards.

(e) Some oceanographic instruments are sold with software that performs semi-automatic processing of the data, often in the field on personal computers. In some instruments, the raw data are discarded and only the Fourier coefficients saved and recorded. The user of these instruments is urged to obtain as much information as possible on the mathematical algorithms used by the gauge's manufacturer. If these procedures are not the same as those used to analyze other data sets from the area, the summary statistics may not be directly comparable. Even more serious, this author has encountered commercial processing software which was seriously flawed with respect to the calculation of directional spectra. In one field experiment, because the original raw data had not been archived in the gauge, the data could not be reprocessed or the errors corrected. As a result, the multi-month gauge deployment was rendered useless.

(f) In summary, it is vital that the user of wave data be aware of how wave statistics have been calculated and thoroughly understand the limitations and strengths of the computational methods that were employed.

(5) Display of wave data and statistics.

(a) In order to manage the tremendous amount of data that are typically acquired in a field experiment,

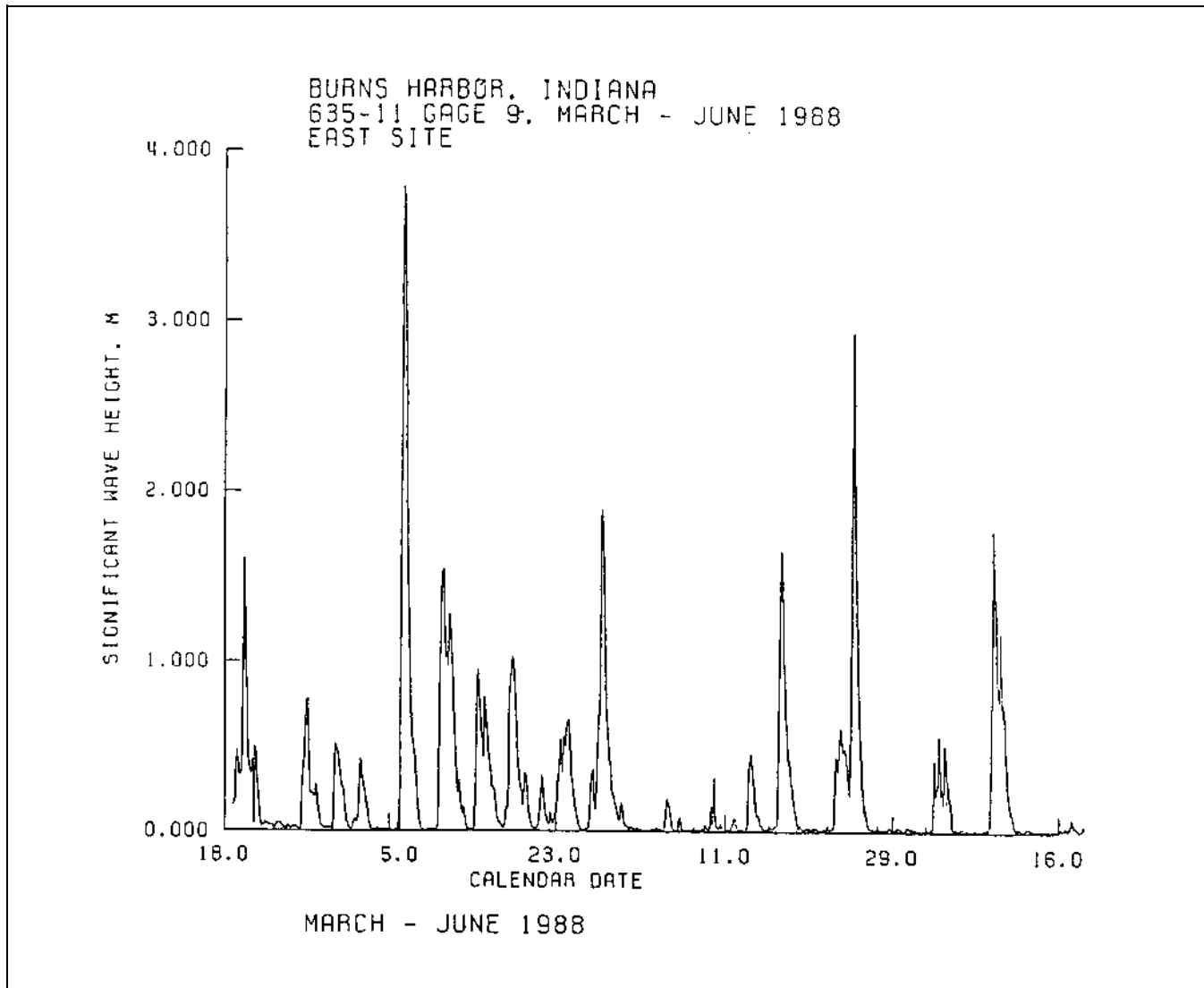

Figure 5-20. Analyzed wave data from Burns Harbor, Indiana. Spikey appearance is caused by plotting almost 3 months of data on one plot

perform quality control, and interpret the results, wave data should be analyzed as soon as possible. In addition, there is often an urgent need to examine the raw data to ascertain whether the gauges can be redeployed or must be repaired.

(b) Figures 5-17 and 5-19 are examples of pressure plotted against time. The value of this form of display for quality control purposes has been demonstrated, but these plots are of limited value in revealing information about the overall nature of the wave climate in the study area.

(c) To review the data from an extended deployment, the summary statistics must be tabulated or plotted.

Figure 5-22 is an example of tabulated directional wave data from a Florida project site. These same data are graphically displayed in Figure 5-23. The upper plot shows H_{m0} wave height, the center peak period, and the lower peak direction. Although other statistics could have been plotted on the same page, there is a danger of making a display too confusing. The advantage of the tabulation is that values from individual wave bursts can be examined. The disadvantage is that it is difficult to detect overall trends, especially if the records extend over many months. As data collection and processing procedures improve, and as more and more data are acquired at field projects, it will be increasingly difficult to display the

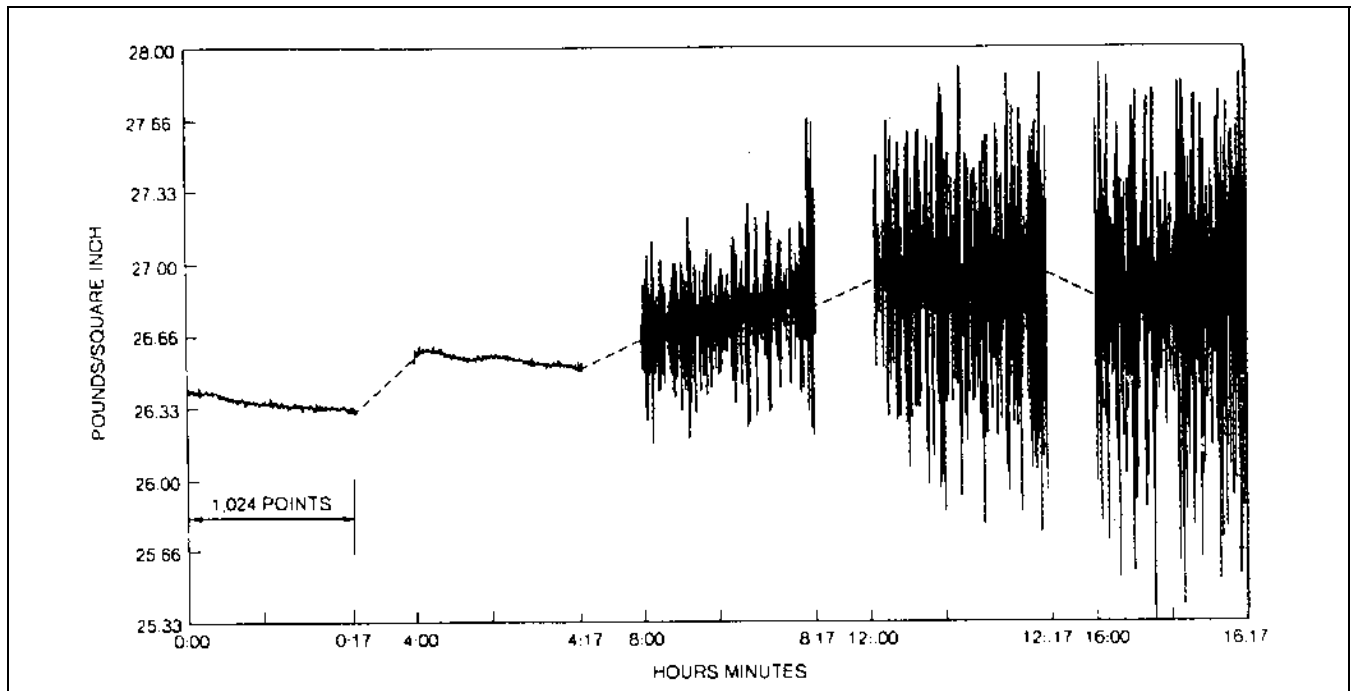

Figure 5-21. Pressure data from Burns Harbor, Indiana, April 6, 1988. This plot shows how dramatically the energy can increase in only a few hours

results in a useful and flexible format that does not overwhelm the end user but yet also does not oversimplify the situation.

(6) Applications of wave data. One important use of wave climate data in coastal engineering is in the construction of wave refraction diagrams. These demonstrate how nearshore bathymetry influences the direction of waves approaching the shoreline. This information can be used to estimate mass transport and longshore transport of sediment, which, in turn, can be used to predict morphologic changes under both natural and structurally influenced coasts. Wave refraction analyses can also be used for hypothetical scenarios, such as predicting the effects on incident waves of dredging an offshore shoal or dumping dredged materials offshore.

c. Water level records.

(1) Changes in water levels along coastlines have profound influence on the geology, the natural ecology, and human habitation in these regions. Predicting and understanding these changes can guide coastal planners in developing rational plans for coastal development and in the design, construction, and operation of coastal structures and waterways. Causes of sea level changes along open coasts have been discussed in Chapter 2.

(2) Tide gauge records may be analyzed for spatial interpolation and for assessing temporal variations such as surges, tides, seasonal changes, and long-term trends. Discrepancies between the predicted tide at one site and the actual tide measured only a short distance away may be considerable. A method for adjusting between predicted tides at a station and those at a nearby study area using only limited field measurements is discussed by Glen (1979). Other analysis methods are discussed in EM 1110-2-1414.

(3) For engineering projects, assessments of short-term water level changes range from simple plotting of data to more sophisticated mathematical analyses. In some cases, some of the components that drive water level changes can be isolated. To assess longer (multiyear) trends, it is important to dampen or separate the effects of yearly variability so that the nature of the secular trends becomes more pronounced. Least-squares regression methods are typically inadequate because the secular trends often show pronounced nonlinearity (Hicks 1972). It may also be important to examine long-term periodic effects in a long data record such as the 18.6-year nodal period, which Wells and Coleman (1981) concluded was important for mudflat stabilization in Surinam.

Table 5-11
Sea State Parameters

Symbol	Description	Units
Basic Terms		
a	Amplitude	m
c	Phase velocity or celerity	m/sec
c_g	Group velocity	m/sec
f	Frequency	Hz
H	Wave height	m
L	Wave length measured in the direction of wave propagation	m
T	Wave period $1/f$	sec
Θ	Direction of wave propagation as used in directional spectra	deg
Δf	Basic frequency increment in discrete Fourier analysis	Hz
σ	Standard deviation	m
General Parameters		
f_p	Spectral peak frequency $1/T_p$	Hz
H_s	Significant wave height defined as the highest one-third of the wave heights calculated as $H_{1/3, \text{downcrossing}}$ or $H_{1/3, \text{upcrossing}}$	m
T_p	Spectral peak period $1/f_p$	sec
Time Domain Analysis Functions		
$H_{1/3,d}$	Zero-downcrossing significant wave height. Average of the highest one-third zero-downcrossing wave heights	m
$H_{1/3,u}$	Zero-upcrossing significant wave height	m
Frequency Domain Analysis Parameters		
f_p	Spectral peak frequency. This frequency may be estimated by different methods, such as: (1) Frequency at which $S_w(f)$ is a maximum; (2) Fitting a theoretical spectral model to the spectral estimates	Hz
H_{mo}	Estimate of significant wave height, $4\sqrt{m_0}$	m^2/Hz
m_n	n th moment of spectral density	m^2/sec^n
$S(f)$	Spectral density	m^2/Hz
T_p	Spectral peak period $1/f_p$	sec
Directional Parameters and Functions		
k	Wave vector	rad/m
$d(f,\Theta)$	Directional spreading function	deg
$S(f,\Theta)$	Directional spectral density	$(\text{m}^2/\text{Hz})/\text{deg}$
α	Wave direction. This is the commonly used wave-direction parameter, representing the angle between true north and the direction from which the waves are coming. Clockwise is positive in this definition	deg
Θ	Direction of wave propagation describing the direction of k . Counterclockwise is positive	deg
$\Theta_m(f)$	Mean wave direction as a function of frequency. The mean of all $\Theta_m(f)$ is known as the overall wave direction	deg

(Condensed from IAHR Working Group on Wave Generation and Analysis (1989))

Table 5-12
Reporting Conventions for Directional Environmental Measurements

Type	Convention	Example
Wind	FROM WHICH wind is blowing	North wind blows from 0 deg
Waves	FROM WHICH waves come	West waves come from 270 deg
Unidirectional currents	TO WHICH currents are flowing	East current flowing to 90 deg

(4) Historic water levels have been used by Hands (1979, 1980) to examine the changes in rates of shore retreat in Lake Michigan and to predict beach/nearshore profile adjustments to rising water levels. Additional research is being sponsored by the International Joint Commission to model how changing water levels affect erosion of various bluff stratigraphies and the nearshore profile.

d. Current records. Current data are often critical for evaluating longshore and cross-shore sediment transport and for evaluating hydraulic processes in inlets and other restricted waterways. Currents, which are generated by a variety of mechanisms, vary greatly spatially and temporally in both magnitude and direction. Four general classes of unidirectional flow affect coastal environments and produce geologic changes. These include:

- Nearshore wave-induced currents, including longshore and rip currents.
- Flow in tidal channels and inlets, which typically changes direction diurnally or semi-diurnally, depending on the type of tide along the adjacent coast.
- River discharge.
- Oceanic currents, which flow along continental land masses.

This section will briefly discuss the first two of these topics and present data examples. The third and fourth are beyond the scope of this manual, and the reader is referred to outside references for additional information.

(1) Nearshore wave-induced currents.

(a) In theory, one of the main purposes for measuring nearshore, wave-induced currents is to estimate longshore transport of sediments. At the present level of technology

and mathematical knowledge of the physics of sediment transport, the direct long-term measurement of longshore currents by gauges is impractical. Two main reasons account for this situation. First, deployment, use, and maintenance of instruments in the nearshore and the surf zone are difficult and costly. Second, the mechanics of sediment transport are still little-understood, and no one mathematical procedure is yet accepted as the definitive method to calculate sediment transport, even when currents, grain size, topography, and other parameters are known. An additional consideration is how to monitor the variation of current flow across and along the surf zone. Because of the extreme difficulty of obtaining data from the surf zone, neither the cross-shore variations of currents nor the temporal changes in longshore currents are well known.

(b) Longshore (or littoral) drift is defined as: "Material (such as shingle, gravel, sand, and shell fragments) that is moved along the shore by a littoral current" (Bates and Jackson 1984). Net longshore drift refers to the difference between the volume of material moving in one direction along the coast and that moving in the opposite direction (Bascom 1964). Along most coasts, longshore currents change directions throughout the year. In some areas, changes occur in cycles of a few days, while in others the cycles may be seasonal. Therefore, one difficulty in determining net drift is defining a pertinent time frame. Net drift averaged over years or decades may conceal the fact that significant amounts of material may also flow in the opposite direction.

(c) Because net longshore currents may vary greatly from year to year along a stretch of coastline, it would be desirable to deploy current meters at a site for several years in order to obtain the greatest amount of data possible. Unfortunately, the cost of a multi-year deployment could be prohibitive. Even a long deployment might not detect patterns that vary on decade-long scales, such as the climatic changes associated with El Niño. At a minimum, near-shore currents should be monitored at a field site for at least a year in order to assess the changes associated with the passing seasons. Coastal scientists and engineers must be aware of the limitations of field current data and recognize that long-term changes in circulation patterns may remain undetected despite the best field monitoring efforts.

(2) Flow in tidal channels and inlets.

(a) An inlet is "a small, narrow opening in a shoreline, through which water penetrates into the land" (Bates

EAST PASS, DESTIN, FLORIDA
635-9 GAGE 03
APRIL - JUNE 1989
(OFF OKALOOSA PIER, FT. WALTON BEACH)

ANALYSIS SUMMARY
PUV Version 3.5
20-JAN-90
CEWES-CD-P

MM	DY	YR	HRMN	HmO (M)	TP (SEC)	Dp (DEG)	AVE.CUR (M/SEC)	C.DIR. (DEG)	DEPTH (M)
6	6	89	1230	0.64	5.4	182	0.34	296	9.8
6	6	89	1830	1.02	6.2	209	0.36	273	9.3
6	7	89	30	1.29	6.6	203	0.39	275	9.3
6	7	89	630	0.98	6.6	200	0.36	310	9.5
6	7	89	1230	0.91	6.6	204	0.24	301	9.8
6	7	89	1830	0.75	6.9	201	0.20	273	9.4
6	8	89	30	0.65	5.4	207	0.17	240	9.4
6	8	89	630	1.24	5.2	192	0.28	287	9.7
6	8	89	1230	2.21	7.3	200	0.60	297	10.0
6	8	89	1830	2.56	8.8	193	0.64	209	9.5
6	9	89	30	2.40	9.5	194	0.59	187	9.4
6	9	89	630	1.71	8.8	206	0.48	352	9.5
6	9	89	1230	1.45	7.8	202	0.40	203	9.7
6	9	89	1830	1.49	8.8	200	0.42	292	9.5
6	10	89	30	1.16	7.8	204	0.35	281	9.4
6	10	89	630	0.83	6.6	206	0.26	272	9.5
6	10	89	1230	0.83	7.3	198	0.25	279	9.6
6	10	89	1830	0.73	6.9	203	0.20	250	9.4
6	11	89	30	0.58	7.3	201	0.18	269	9.4
6	11	89	630	0.56	6.9	205	0.15	144	9.5
6	11	89	1230	0.56	6.6	203	0.15	15	9.5
6	11	89	1830	0.54	6.6	211	0.13	138	9.4
6	12	89	30	0.43	6.6	213	0.12	111	9.4
6	12	89	630	0.48	5.4	209	0.12	118	9.5
6	12	89	1230	0.49	4.5	224	0.10	109	9.4
6	12	89	1830	0.50	5.2	216	0.12	246	9.4
6	13	89	30	0.47	4.2	233	0.12	129	9.5
6	13	89	630	0.68	4.7	219	0.12	265	9.6
6	13	89	1230	0.67	5.0	225	0.17	271	9.4
6	13	89	1830	0.56	4.7	213	0.20	274	9.3
6	14	89	30	0.68	4.7	215	0.24	282	9.5
6	14	89	630	0.70	5.0	220	0.14	203	9.6
6	14	89	1230	0.67	5.2	212	0.14	254	9.4
6	14	89	1830	1.12	5.7	213	0.24	209	9.3
6	15	89	30	1.32	6.9	218	0.34	267	9.5
6	15	89	630	1.87	6.9	213	0.46	267	9.8
6	15	89	1230	1.97	8.3	201	0.51	269	9.5
6	15	89	1830	1.56	8.8	201	0.43	337	9.3
6	16	89	30	1.25	7.3	212	0.34	305	9.5
6	16	89	630	1.45	5.2	206	0.31	248	9.8
6	16	89	1230	1.91	7.8	203	0.48	3	9.4
6	16	89	1830	1.06	7.8	214	0.34	280	9.2
6	17	89	30	1.07	6.6	203	0.31	298	9.5
6	17	89	630	0.94	6.2	206	0.33	289	9.8
6	17	89	1230	0.77	6.0	198	0.21	260	9.5
6	17	89	1830	0.60	6.6	199	0.20	278	9.2
6	18	89	30	0.47	6.9	197	0.17	289	9.4
6	18	89	630	0.50	5.2	185	0.19	290	9.8
6	18	89	1230	0.49	6.0	180	0.22	270	9.6

Figure 5-22. Example of tabular summary of wave data from offshore Fort Walton Beach, Florida

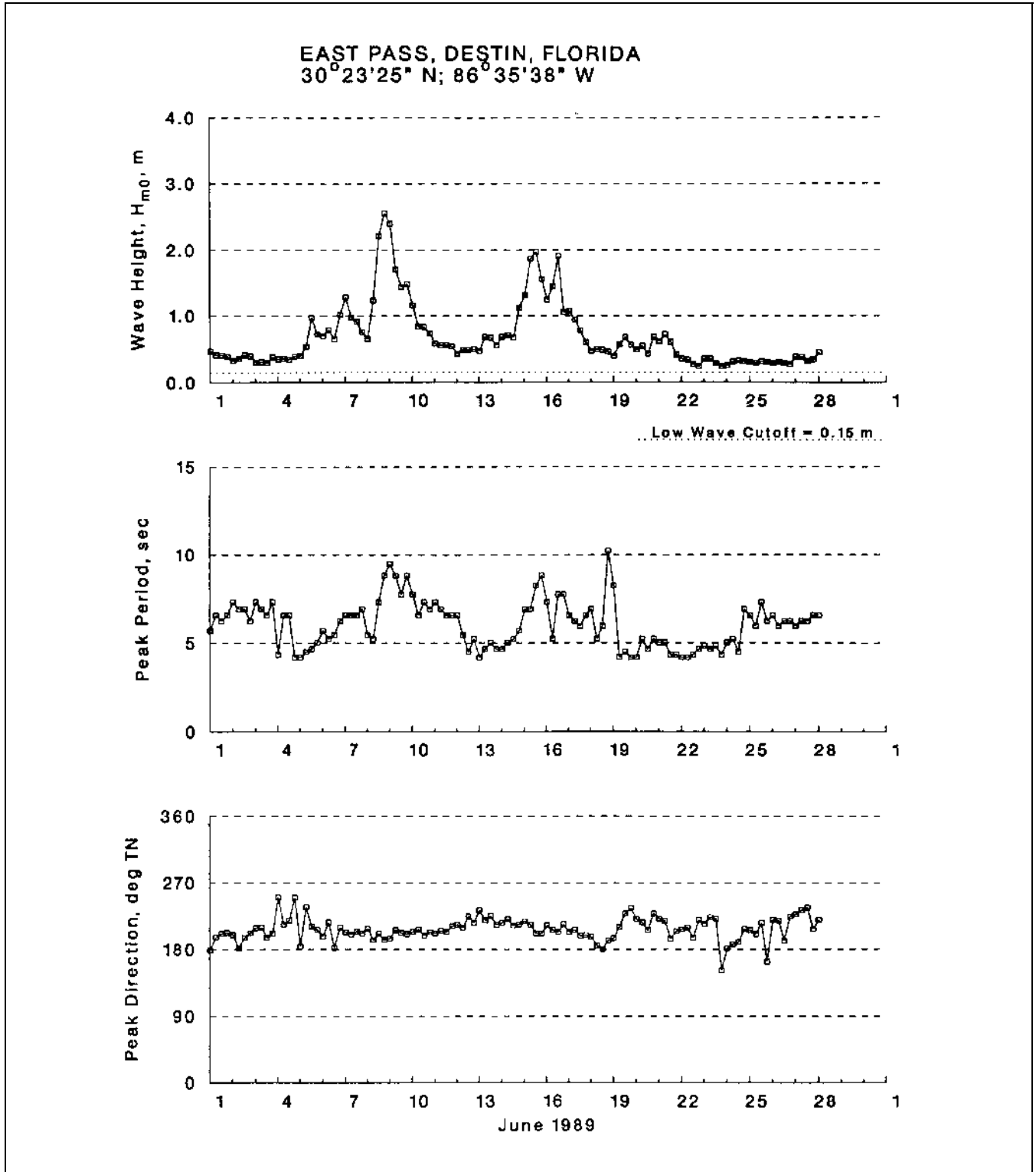

Figure 5-23. Plots of wave height, peak period, and peak direction from offshore Fort Walton Beach, Florida

and Jackson 1984). Inlets range in size from short, narrow breaches in barrier islands to wide entrances of major estuaries like Chesapeake Bay. Many geologic and engineering studies concern flow through tidal inlets in sand-dominated barriers, particularly when the inlets serve as navigation channels connecting harbors to the open sea.

(b) Inlets allow for the exchange of water between the sea and the bay during each tidal cycle. Therefore, currents in tidal inlets are typically unidirectional, changing direction diurnally or semidiurnally, depending upon the tides along the adjacent open coast. Flow through the inlets can be complicated by the hydrodynamics of the inland bay, especially if there are other openings to the sea.

(c) Various numerical and conceptual models have been developed to describe flow through inlets and allow researchers to predict the effects of changing inlet dimensions, lengths, and orientations (Aubrey and Weishar 1988; Escoffier 1977; Seelig, Harris, and Herchenroder 1977; *Shore Protection Manual* 1984). Most models, however, benefit from or require calibration with physical measurements made within the inlet and the general vicinity. The required field measurements are usually either tidal elevations from the open sea and within the adjacent bay or actual current velocities from within the inlet's throat.

(d) Display of tidal elevation data is relatively straightforward, usually consisting of date or time on the x-axis and elevation on the y-axis. Examples of tidal elevations from a bay and an inlet in the Florida Panhandle are shown in Figure 5-6. Although the overall envelope of the curves is similar, each one is unique with respect to the heights of the peaks and the time lags. The curves could be superimposed to allow direct comparison, but, at least at this 1-month-long time scale, the result would be too complicated to be useful.

(e) Display of current meter measurements is more difficult because of the large quantity of data usually collected. An added difficulty is posed by the changing currents within an inlet, which require a three-dimensional representation of the flow which varies with time. Current measurements from East Pass, Florida, collected during three field experiments in the mid-1980's are presented as examples. Currents were measured with manual Price type AA meters deployed from boats and with tethered Endeco 174 current meters. The manual measurements were made hourly for 24 hr in order to observe a complete tidal cycle. The measurements were made across the inlet at four stations, each one consisting of a

near-surface, a mid-depth, and a near-bottom observation (Figure 5-24). Therefore, 12 direction and velocity data values were obtained at each hour (Figure 5-25). One way to graphically display these values is to plot the velocities on a plan view of the physical setting, as shown in Figure 5-24. This type of image clearly shows the directions and relative magnitudes of the currents. In this example, the data reveal that the currents flow in opposite directions in the opposite halves of the inlet. The disadvantage of the plan view is that it is an instantaneous snapshot of the currents, and the viewer cannot follow the changes in current directions and magnitudes over time unless the figure is redrawn for each time increment. Temporal changes of the currents can be shown on dual plots of magnitude and direction (Figure 5-26). Unfortunately, to avoid complexity, it is not reasonable to plot the data from all 12 measurement locations on a single page.

Therefore, measurements from the same depth are plotted together, as in Figure 5-26, or all measurements from one site can be plotted together (top, middle, and bottom).

(f) In summary, current data can be displayed in the form of instantaneous snapshots of the current vectors or as time series curves of individual stations. Many plots are usually needed to display the data collected from even short field projects. It may be advantageous to present these plots in a data appendix rather than within the text of a report.

(3) Error analysis of current data.

(a) Error analysis of current records can be broadly divided into two categories. The first concerns calibrations of the actual current sensing instruments. A user needs to know how closely the numbers reported by a particular instrument represent the water motions that it is purported to be measuring. This information is important for both evaluation of existing data sets and for planning of new field experiments, where some instruments may be more suitable than others.

(b) The second broad question pertains to whether the measurements which have been gathered adequately represent the flow field in the inlet or channel that is being examined. This second problem is exceedingly difficult to evaluate because it raises the fundamental questions of "How much data do I need?" and, "Can I afford to collect the data that will really answer my questions?" The user is typically tempted to respond that he wants just as much data as possible, but this may prove to be counterproductive. For example, if the

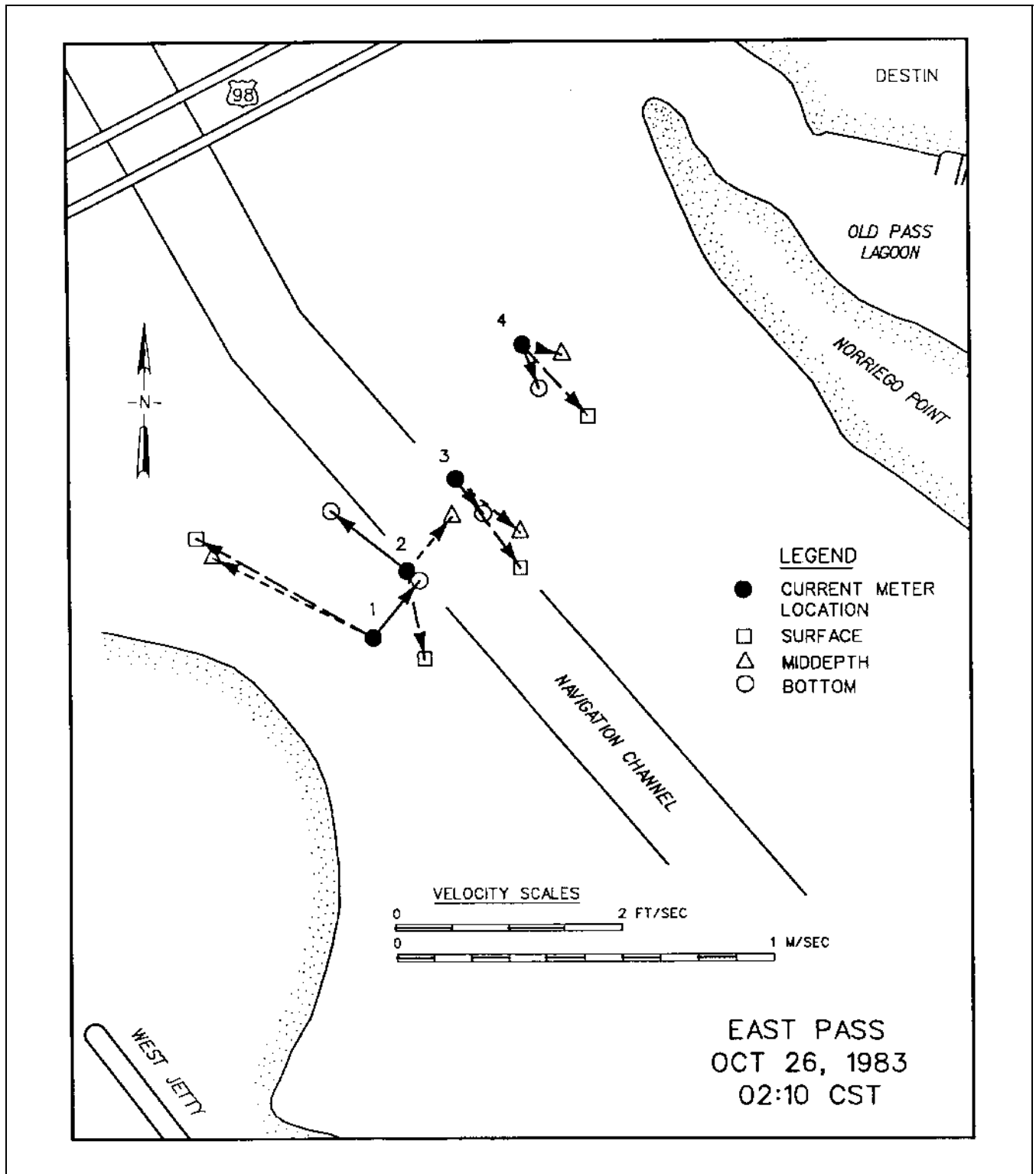

Figure 5-24. Current measurement stations in East Pass Inlet, Destin, Florida, during October, 1983. Measurements were made hourly from small boats. At 02:10 CST, currents were flowing to the northwest along the west side of the inlet and to the southeast along the center and east sides of the inlet. Station 2 was in the mixing zone

DESTIN (EAST PASS) TIDE STUDY

U.S. ARMY ENGINEER DISTRICT, MOBILE

Project DESTIN TIDE STUDY	Date 26 OCT 83	Page 7	of 12	Pages
Boat SKI BARGE	Meter No. PRICE TYPE STANDARD	Dir. Ind. No. WES 23		
Observers JAB	JHL	JTM		
Range EAST PASS SOUTH OF US 98 BRIDGE STARTED @ STATION # 1 @ BEACON # 9 (WEST TO EAST)				

* DST = DAYLIGHT SAVING TIME / SUBTRACT ONE HOUR FOR STANDARD TIME

Sta No.	* Military Time	Feet Below Surface	Current			Remarks	Sta No.	* Military Time	Feet Below Surface	Current		
			Dir Mag	Rev Time	Velocity Ft/Sec					Dir Mag	Rev Time	Velocity Ft/Sec
1	0200	S 4.16	135	20/49	1.910	ANCHOR WINDY CHOPPY SEAS FLOOD TIDE	1	0302	S 3.80	EBB 122	20/48	1.84
		M 10.4	150	20/50	1.892				M 9.56	EBB 120	20/49	1.80
		B 16.6 20.8	128	20/64	1.701				B 15.4 19.2	EBB 220	20/45	1.989
2	0206	S 4.16	128	30/50	1.33	ANCHOR WINDY CHOPPY SEAS FLOOD TIDE	2	0307	S 3.62	EBB 350	20/51	1.815
		M 10.4	125	20/42	1.06				M 9.20	EBB 230	20/51	1.875
		B 16.6 20.8	150	20/42	1.06				B 14.8 18.4	FLOOD 130	20/42	1.06
3	0211	S 2.44	120	30/42	1.58	ANCHOR WINDY CHOPPY SEAS FLOOD TIDE	3	0321	S 2.40	EBB 325	20/47	1.948
		M 6.10	120	30/42	1.58				M 6.00	EBB 310	20/50	1.892
		B 8.9 12.2	118	30/41	1.62				B 9.2 12.1	EBB 320	20/64	1.701
4	0216	S 2.92	122	30/50	1.33	ANCHOR WINDY CHOPPY SEAS FLOOD TIDE	4	0326	S 2.92	EBB 320	20/49	1.910
		M 7.30	125	30/51	1.30				M 7.30	EBB 295	10/41	1.552
		B 11.1 14.6	122	20/43	1.03				B 11.1 14.6	EBB 340	20/62	1.723
		S						S				
		M						M				
		B						B				
		S						S				
		M						M				
		B						B				

Figure 5-25. Example of handwritten field notes listing times and data values of East Pass current measurements. The data are efficiently presented but difficult to visualize

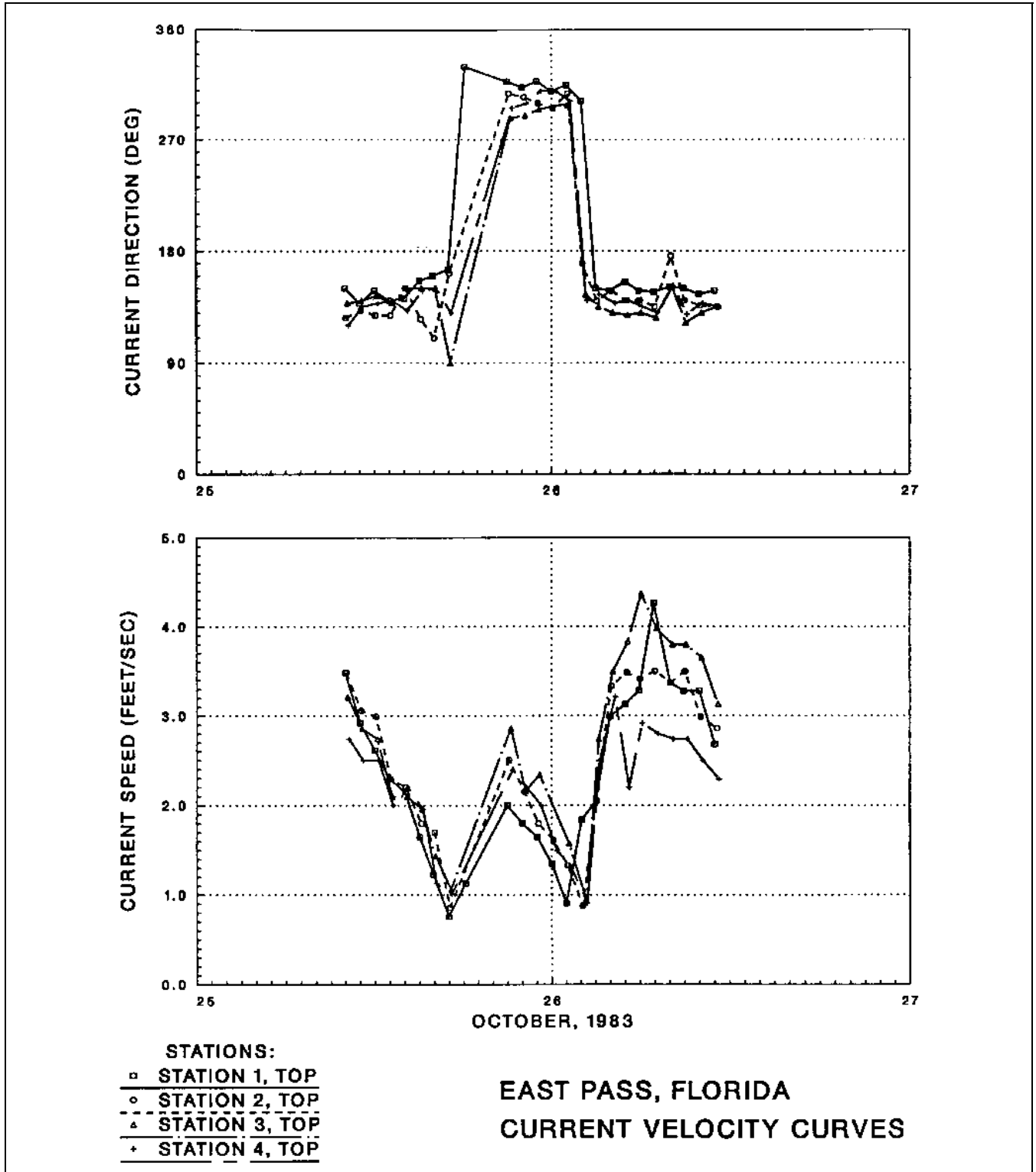

Figure 5-26. Time series plots of East Pass current speed (bottom) and direction (top)

currents in an inlet are being measured to determine variations in the tidal prism over time, will a dense gridwork of sampling stations in an inlet provide more useful data? Or might the excess data reveal unnecessary details about turbulence and mixing in the inlet? These are intrinsically interesting questions, but may not be germane to the engineering problems that must be addressed. Although the dense grid pattern of data can be used to evaluate overall flow, the collection, analysis, and management of the excess data can be costly and time-consuming. The money used on management of this data might be better spent extending a simpler sampling program for a longer period at the site. Unfortunately, there are no firm guidelines to planning current studies and placing instruments.

(c) Analysis of error from various types of current sensors has been the subject of extensive study in the last 30 years. Numerous types of error can occur, both during field deployment of the instrument and during data processing. These can result from instrument calibration, clock time errors, and data recording and playback. In addition, the user is cautioned that each of the many types and brands of current meters is capable of recording accurately only a segment of the spectrum of water motions because of the influence of the mooring assembly, type of velocity sensor used, and recording scheme of the instrument (Halpern 1980). Halpern's (1980) paper lists many references pertaining to the results of tests of moored current meters.

(d) Manufacturers of current meters publish accuracy standards in their literature. These standards may be optimistic, especially under the adverse conditions encountered in many coastal settings. In addition, the type of mooring used for the instrument affects the quality of the measured data (Halpern 1978). For these reasons, the user of existing data is urged to obtain as much information as possible regarding the specifics of the deployment and the type of mooring in order to try to assess the accuracy of the results. Ultimately, successful use of current gauges is critically dependent upon the planning of the experiment and upon the care and skill of the technicians who maintain and deploy the instruments.

(4) River discharge.

(a) River outflow has a major effect on some coastlines, particularly where massive deltas have formed (e.g. Mississippi Delta). Even if a study area is not located on a delta, coastal researchers must be aware of the potential impact of rivers on coastal processes, especially if the

study region is affected by freshwater runoff at certain seasons or if longshore currents carry river-derived sediment along the shore.

(b) River discharge data are available for many coastal rivers. A cursory examination of the annual hydrograph will reveal the seasonal extremes. Because of the episodic nature of coastal flooding, annual discharge figures may be misleading. A useful parameter to estimate river influence on the coast is the hydrographic ratio (H_R), which compares tidal prism volume with fluvial discharge volume (Peterson et al. 1984).

(5) Oceanic currents.

(a) Major oceanic currents intrude onto some continental shelves with enough bottom velocity to transport sandy sediments. The currents operate most effectively on the outer shelf, where they may transport significant volumes of fine-grained sediments but presumably contribute little if any new sediment (Boggs 1987). Along most coastlines, ocean currents have little direct effect on shoreline sedimentation or erosion. Even off southeast Florida, where the continental shelf is narrow, the western edge of the Gulf Stream flows at least 1/2 km offshore. However, in some locations where currents approach the coastal zone, sediment discharged from rivers is transported and dispersed along the adjacent coastline. This process may arrest the seaward progradation of the delta front, while causing extensive accumulations of riverine-derived clastics downdrift of the river mouth (Wright 1985).

(b) In shallow carbonate environments, reefs thrive where currents supply clean, fresh ocean water. Reefs stabilize the bottom, provide habitat for marine life, produce carbonate sediment, and sometimes protect the adjoining shore from direct wave attack (i.e., the Great Barrier reef of Australia). In the United States, live reefs are found in the Gulf of Mexico off Texas and west Florida and in the Atlantic off Florida. Coral islands are found in the Pacific in the United States Trust Territories. For geologic or engineering studies in these environments, there may be occasional need to monitor currents. Procedures of deepwater current measurement are presented in Appell and Curtin (1990) and McCullough (1980).

(c) In summary, the effect of tide or wave-induced currents is likely to be much more important to most coastal processes than ocean currents. Measurement of ocean currents may occasionally be necessary for geologic studies in deltaic or carbonate environments.

e. *Shoreline change mapping*¹.

(1) Introduction.

(a) Maps and aerial photographs can provide a wealth of useful information for the interpretation of geologic coastal processes and evolution. Maps and photographs can reveal details on:

- Long-term and short-term advance or retreat of the shore.
- Longshore movement of sediments.
- The impact of storms, including barrier island breaches, overwash, and changes in inlets, vegetation, and dunes.
- Problems of siltation associated with tidal inlets, river mouths, estuaries, and harbors.
- Human impacts caused by construction or dredging.
- Compliance with permits.
- Biological condition of wetlands and estuaries.

(b) The use of maps and aerial photographs to determine historical changes in shoreline position is increasing rapidly. Analyzing existing maps does not require extensive field time or expensive equipment, therefore often providing valuable information at an economical price. This section summarizes the interpretation of shorelines on photographs and maps and corrections needed to convert historic maps to contemporary projections and coordinate systems.

(c) Many possible datums can be used to monitor historical changes of the shoreline. In many situations, the high water line (hwl) has been found to be the best indicator of the land-water interface, the coastline (Crowell, Leatherman, and Buckley 1991). The hwl is easily recognizable in the field and can usually be approximated from aerial photographs by a change in color or shade of the beach sand. The datum printed on the NOS T-sheets is listed as "Mean High Water." Fortunately, the early NOS topographers approximated hwl during their survey procedures. Therefore, direct

comparisons between historical T-sheets and modern aerial photographs are possible. In order to calculate the genuine long-term shoreline change, seasonal beach width variations and other short-term changes should be filtered out of the record. The best approach is to use only maps and aerial images from the same season, preferably summertime, when the beach is exposed at its maximum width.

(d) A crucial problem underlying the analysis of all historical maps is that they must be corrected to reflect a common datum and brought to a common scale, projection, and coordinate system before data from successive maps can be compared (Anders and Byrnes 1991). Maps made before 1927 have obsolete latitude-longitude coordinate systems (U.S. datum or North American (NA) datum) that must be updated to the current standard of NAD 1927 or the more recent NAD 1983. To align maps to a specific coordinate system, a number of stable and permanent points or features must be identified for which accurate and current geographic coordinates are known. These locations, called primary control points, are used by computer mapping programs to calculate the transformations necessary to change the map's projection and scale. The most suitable control points are triangulation stations whose current coordinates are available from the National Geodetic Survey.

(e) Maps that were originally printed on paper have been subjected to varying amounts of shrinkage. The problem is particularly difficult to correct if the shrinkage along the paper's grain is different than across the grain. Maps with this problem have to be rectified or discarded. In addition, tears, creases, folds, and faded areas in paper maps must be corrected.

(f) Air photographs, which are not map projections, must be corrected by optical or computerized methods before shore positions compiled from the photos can be directly compared with those plotted on maps. The distortion correction procedures are involved because photos do not contain defined control points like latitude-longitude marks or triangulation stations. On many images, however, secondary control points can be obtained by matching prominent features such as the corners of buildings or road intersections with their mapped counterparts (Crowell, Leatherman, and Buckley 1991). Types of distortion which must be corrected include:

- Tilt. Almost all vertical aerial photographs are tilted, with 1 deg being common and 3 deg not unusual (Lillesand and Kiefer 1987). The scale across tilted air photos is non-orthogonal,

¹ Material in this section adapted from Byrnes and Hiland (1994) and other sources.

resulting in gross displacement of features depending upon the degree of tilt.

- Variable scale. Planes are unable to fly at a constant altitude. Therefore, each photograph in a series varies in scale. A zoom transfer scope can be used to remove scale differences between photos.
- Relief displacement. Surfaces which rise above the average land elevation are displaced outward from the photo isocenter. Fortunately, most U.S. coastal areas, especially the Atlantic and Gulf barriers, are relatively flat and distortion caused by relief displacement is minimal. However, when digitizing cliffed shorelines, control points at about the same elevation as the feature being digitized must be selected.
- Radial lens distortion. With older aerial lenses, distortion varied as a function of distance from the photo isocenter. It is impossible to correct for these distortions without knowing the make and model of the lens used for the exposures (Crowell, Leatherman, and Buckley 1991). If overlapping images are available, digitizing the centers, where distortion is least, can minimize the problems.

Fortunately, most errors and inaccuracies from photographic distortion and planimetric conversion can be quantified. Shoreline mapping exercises have shown that if care is taken in all stages of filtering original data sources, digitizing data and performing distortion corrections, the resulting maps meet, and often exceed, National Map Accuracy Standards (Crowell, Leatherman, and Buckley 1991).

(g) In order to accurately document shoreline position and generate shoreline position maps, several steps are needed to quantify shoreline change. These steps include assembling data sources, entering data, digitizing coordinates, analyzing potential errors, computing shoreline change statistics, and interpreting shoreline trends. Based on shoreline change studies conducted at universities and Federal, State, and local agencies, a brief summary of the recommended techniques and procedures is given below.

(2) Data sources. Five potential data sources exist for assessing spatial and temporal changes in shoreline position. These include United States Geological Survey (USGS) topographic quadrangles, National Ocean Service

(NOS) topographic sheets, local engineering surveys, near-vertical aerial photographs, and GPS surveys. Each data source addresses a specific mapping purpose, as described below.

(a) USGS topographic maps. The most common maps used for documenting changes along the coast are USGS topographic quadrangle maps. These maps are created at a range of scales from 1:24,000 to 1:250,000 (Ellis 1978). The primary purpose of these maps is to portray the shape and elevation of the terrain above a given datum, usually the mean high water line. Accurate delineation of the shoreline was not a primary concern on these land-oriented maps. However, shoreline position routinely is revised on 1:24,000 topographic maps using aerial photographic surveys. Many shoreline mapping studies have used these maps for quantifying changes in position, but more accurate and appropriate sources should be employed if available.

(b) NOS Topographic Maps. Another type of topographic map is that produced by the U.S. Coast and Geodetic Survey (USC&GS) (now National Ocean Survey - NOS). Because this agency is responsible for surveying and mapping topographic information along the coast, topographic map products (T-sheets) have been used in the study of coastal erosion and protection, and frequently in law courts in the investigation of land ownership (Shalowitz 1962). Most of these maps are planimetric in that only horizontal position of selected features is recorded; the primary mapped feature is the high-water shoreline. From 1835 to 1927, almost all topographic surveys were made by plane table; most post-1927 maps were produced using aerial photographs and photogrammetric methods (Shalowitz 1964). NOS shoreline position data are often used on USGS topographic quadrangles, suggesting that T-sheets are the primary source for accurate shoreline surveys. Scales of topographic surveys are generally 1:10,000 or 1:20,000. These large-scale products provide the most accurate representation of shoreline position other than direct field measurements using surveying methods.

(c) Large-scale engineering surveys. In areas of significant human activity, engineering site maps often exist for specific coastal regions. However, surveyed areas often are quite limited by the scope of the project; regional mapping at large scale (greater than 1:5,000) is sparse. If these data do exist, they potentially provide the most accurate estimates of high-water shoreline position and should be used. These data are valuable for rectifying aerial photography for mapping shoreline position.

(d) Near-vertical aerial photography. Since the 1920's, aerial photography has been used to record shoreline characteristics in many coastal regions. However, these data cannot be used directly to produce a map. Aircraft tilt and relief may cause serious distortions that have to be removed by rectification. A number of graphical methods and computational routines exist for removing distortions inherent in photography (Leatherman 1984; Anders and Byrnes 1991). Orthophotoquadrangles and orthophotomosaics are photomaps made by applying differential rectification techniques (stereo plotters) to remove photographic distortions. Users are warned that conversion of photographic images to map projections is not a trivial procedure, despite the availability of modern cartographic software. Ease of data collection and the synoptic nature of this data source provide a significant advantage over most standard surveying techniques.

(e) GPS surveys. During the late 1970's through the 1980's, significant advances in satellite surveying were made with the development of the Navigation Satellite Timing and Ranging (NAVSTAR) Global Positioning System (GPS). The GPS was developed to support military navigation and timing needs; however, many other applications are possible with the current level of technology. This surveying technique can be very accurate under certain conditions; however, signal degradation through selective availability causes significant positional errors if only one station is being used (Leick 1990). Differential GPS provides the capability for accurately delineating high-water shoreline position from ground surveys.

(3) Data entry.

(a) Frequently, shoreline maps have variable scales and use different datums and coordinate systems. Shoreline maps should be corrected to reflect a common datum and brought to a common scale, projection, and coordinate system before data from successive maps can accurately be compared. There are several computer cartographic systems, consisting of a high-precision digitizing table and cursor and computer interface, available. Ideally, a GIS system should be used to digitize various data sources and store the information in data layers that can be linked to a relational database. Most systems have a table or comment file associated with each data layer to document the original map source, cartographic methods, and potential errors.

(b) Digitized shoreline points are commonly entered into an X-Y data file for each shoreline source. Data transformation to a common surface can be converted using standard mapping software packages. A header or

comment line should be incorporated into the digital record of the cartographic parameters, i.e., map scale, projection, and horizontal and vertical datums. Datum shifts can account for significant changes in historical maps generated in the 1800's.

(c) Another transformation is the projection of the earth's spherical shape onto a two-dimensional map. The method by which the earth's coordinates are transferred to a map is referred to as the map projection. Commonly used projections include:

- Lambert projection - scaled to correct along two standard parallels; base for state plane coordinates.
- Mercator projection - scaled along uniformly spaced straight parallel lines; used for NOS T- and H-sheets.
- Transverse Mercator projection - essentially the standard Mercator rotated through 90 deg; used for all large scale maps such as USGS 7½' quadrangles.

Additional projections are described in Ellis (1978).

(d) Before the shoreline is digitized, triangulation points should be digitized for each shoreline map. The triangulation stations provide control points, which are crucial when using older maps or a multitude of different map sources (Shalowitz 1964). Older maps may contain misplaced coordinate systems. If there is not enough information on the coordinate system or triangulation station, the map should not be used for quantitative data. A useful source of available U.S. triangulation stations is *Datum Differences* (USC&GS 1985).

(e) Media distortion can be eliminated by using maps drawn on stable-base materials such as NOS T- and H-sheets. Most USACE District project maps are made from Mylar film. The original map or a high-quality Mylar copy should be used as opposed to black-line, blue-line, or other paper-based medium. However, if paper maps are used, and distortion from shrinking and swelling is significant, the digitizer setup provides some degree of correction by distributing error uniformly across the map. In addition, rubber-sheeting and least-squares fit computer programs allow the user to define certain control points and correct for distortion errors as much as possible. It is also important to remember that data in digital form acquire no new distortions, whereas even stable-base maps can be torn, wrinkled, and folded. Scale distortion

from optical methods of map reproduction are also corrected by bringing all maps to a 1:1 scale.

(4) General digitizing guidelines. Cartographic methods and map handling should be consistent within a project and organization. Shoreline digitizing guidelines (summarized by Byrnes and Hiland, in preparation) include:

(a) All shorelines are digitized from stable-base materials. If possible use NOS T- and H-sheets on Mylar, or on bromide if Mylar is not available for a particular map. Shorelines mapped from rectified aerial photography are drawn onto, and digitized from, acetate film.

(b) To prevent curling and wrinkling of maps, store cartographic and photographic materials flat or vertical. Bromide-based maps that are shipped in a map tube should be kept flat for several days before digitizing.

(c) When attaching a map to a digitizer table, the area being digitized is always perfectly flat. Any wrinkles can cause that portion of the map to move during digitizing, creating positional errors. High-quality drafting tape or masking tape is used to attach the map. One corner is taped first, then the map is smoothed diagonally and the opposite corner is taped securely; this procedure is repeated for the other two corners. Once the corners are secured, the map is smoothed from the center to the edges and taped along each edge.

(d) High-precision equipment must be used for accurate shoreline change mapping. Digitizer tables and cursors with a precision of 0.1 mm are recommended. This magnitude of change equates to 1 m of ground distance at a scale of 1:10,000. The center bead or crosshair should ideally be smaller than the width of the line being digitized; the smallest pen width generally available is 0.13 mm. The width of the crosshair of a high-precision cursor is approximately 0.1 mm.

(e) When digitizing, use manual point input as opposed to stream input. Stream input places points at a specified distance as the user traces over the line being digitized. This procedure tends to make a very uniform and smooth line. However, it could miss some curvature in the line if the specified distance is too large; likewise, it could accept more points than are needed if the specified distance is too small, resulting in extremely large files, as well as storage and display problems. In addition, if the user's hand slips during the digitizing process,

stream digitizing will continue to place points in the erroneous locations. These can be difficult and time-consuming to correct. Manual digitizing allows the user to place points at non-uniform distances from each other, and therefore allows the user to represent all variations in the shoreline.

(f) The seaward edge of the high-water shoreline and the center point of the printed bathymetric sounding should be used as the reference positions for data capture.

(5) Potential errors. It is important that all available procedures be used as carefully as possible to capture map data; however, no matter how cautious the approach, a certain amount of error will be generated in all measurements of digitized horizontal position. Potential errors are introduced in two ways. *Accuracy* refers to the degree to which a recorded value conforms to a known standard. In the case of mapping, this relates to how well a position on a map is represented relative to actual ground location. *Precision*, on the other hand, refers to how well a measurement taken from a map or an aerial photograph can be reproduced. Table 5-13 lists the factors affecting the magnitude of error associated with data sources and measurement techniques. Both types of error should be evaluated to gauge the significance of calculated changes relative to inherent inaccuracies. The following discussion addresses these factors in terms of data sources, operator procedures, and equipment limitations.

(6) Cartographic sources.

(a) Shoreline measurements obtained from historical maps can only be as reliable as the original maps themselves. Accuracy depends on the standards to which each original map was made, and on changes which may have occurred to a map since its initial publication. Field and aerial surveys provided the source data used to produce shoreline maps. For T- and H-sheets at a 1:10,000 scale, national standards allow up to 8.5 m of error for a stable point (up to 10.2 m of error at 1:20,000), but the location of these points can be more accurate (Shalowitz 1964; Crowell, Leatherman, and Buckley 1991). Non-stable points are located with less accuracy; however, features critical to safe marine navigation are mapped to accuracy stricter than national standards (Ellis 1978). The shoreline is mapped to within 0.5 mm (at map scale) of true position, which at 1:10,000 scale is 5.0 m on the ground.

(b) Potential error considerations related to field survey equipment and mapping of high-water shoreline

Table 5-13
Factors Affecting Potential Errors Associated with Cartographic Data Sources

Accuracy		Precision
Maps and Charts	Field Surveys and Aerial Photographs	
Scale	Location, Quality, and Quantity of Control Points	Annotation of High-Water Line
Horizontal Datum	Interpretation of High-Water Line	Digitizing Equipment
Shrink/Stretch	Field Surveying Standards	Temporal Data Consistency
Line Thickness	Photogrammetric Standards	Media Consistency
Projection	Aircraft Tilt and Pitch	Operator Consistency
Ellipsoid	Aircraft Altitude Changes	
Publication Standards	Topographic Relief	
	Film Prints Versus Contact Prints	

(After Anders and Byrnes (1991))

position were addressed by Shalowitz (1964; p. 175) as follows:

With the methods used, and assuming the normal control, it was possible to measure distances with an accuracy of 1 meter (Annual Report, U.S. Coast and Geodetic Survey 192, 1880) while the position of the plane table could be determined within 2 or 3 meters of its true position. To this must be added the error due to the identification of the actual mean high water line on the ground, which may approximate 3 to 4 meters. It may therefore be assumed that the accuracy of location of the high-water line on the early surveys is within a maximum error of 10 meters and may possibly be much more accurate than this. This is the accuracy of the actual rodded points along the shore and does not include errors resulting from sketching between points. The latter may, in some cases, amount to as much as 10 meters, particularly where small indentations are not visible to the topographer at the planetable.

The accuracy of the high-water line on early topographic surveys of the Bureau was thus dependent upon a combination of factors, in addition to the personal equation of the individual topographer. But no large errors were allowed to accumulate. By means of the triangulation control, a constant check was kept on the overall accuracy of the work.

(c) In addition to survey limitations listed by Shalowitz (1964), line thickness and cartographic errors (relative location of control points on a map) can be evaluated to provide an estimate of potential inaccuracy

for source information. Although it can be argued that surveys conducted after 1900 were of higher quality than original mapping operations in the 1840's, an absolute difference can not be quantified. Consequently, the parameters outlined above are assumed constant for all field surveys and provide a conservative estimate of potential errors. For the 1857/70 and 1924 T-sheets, digitizer setup recorded an average percent deviation of 0.02, or 4 m ground distance at a 1:20,000 scale. Line thickness, due to original production and photo-reproduction, was no greater than 0.3 mm, or 6 m ground distance for this same scale.

(d) A primary consideration with aerial surveys is the interpreted high-water shoreline position. Because delineation of this feature is done remotely, the potential for error is much greater than field surveys and is a function of geologic control and coastal processes. Dolan et al. (1980) indicated that average high-water line movement over a tidal cycle is about 1 to 2 m along the mid-Atlantic coast; however, accurate delineation of the line is sometimes difficult due to field conditions, knowledge of human impacts, and photographic quality. Although the magnitude of error associated with locating the high-water line is unknown, on gently sloping beaches with large tidal ranges (i.e. Sea Islands, Georgia/South Carolina), significant horizontal displacement can occur with a small increase in elevation.

(e) For H-sheets, a topographical survey of the coast was often conducted before the bathymetric survey. The control points established along the shoreline were then used for positioning of the survey vessel offshore. Due to the nature of triangulating distances and angles from points on land, horizontal positions plotted for the vessel became less accurate as it moved away from shore.

When the vessel was out of sight of the triangulation points along the coast, positioning was done by dead reckoning. Therefore, horizontal positions of some off-shore soundings on early H-sheets may be suspect.

(7) Digitizer limitations. Another source of error relates to equipment and operator accuracy and precision. As stated earlier, the absolute accuracy (accuracy and precision) of the digitizing tables used for this study is 0.1 mm (0.004 in). At a scale of 1:10,000, this converts to ± 1 m. Furthermore, the precision with which an operator can visualize and move the cursor along a line can lead to much greater errors (Tanner 1978). To evaluate the magnitude of operator error associated with digitizing shoreline position, at least three repetitive measurements should be compared.

(8) Analysis of shoreline change data.

(a) In most instances, data pairs are generated from shoreline locations relative to some arbitrary axis system. A comparison of these data pairs is used to calculate mean shoreline movements, variations in the rate and direction of movements, and maximum net movements (Anders, Reed, and Meisburger 1990). Generally the coastline is divided into segments based on the general orientation of the shoreline, as shown in Figure 5-27. Baselines should be chosen based on segments that are parallel to the shoreline. Usually a standard Cartesian coordinate system is assigned to each segment with the positive x-axis directed generally north to south and the positive y-axis lying orthogonally seaward. The resulting data pairs include the x-value and the y-value, which represents the perpendicular transect.

(b) Three primary statistics are generally used for shoreline change computations. They include the sample mean, sample standard deviation, and maximum shoreline movement. The sample mean is defined as a measure of central tendency for a set of sample observations and is expressed as follows:

$$\bar{x} = \frac{\sum_{i=1}^n x_i}{n} \quad (5-1)$$

where x_i = sample observations for $i = 1$ to n and n = total number of observations. The sample standard deviation s is a measure of sample variability about the mean.

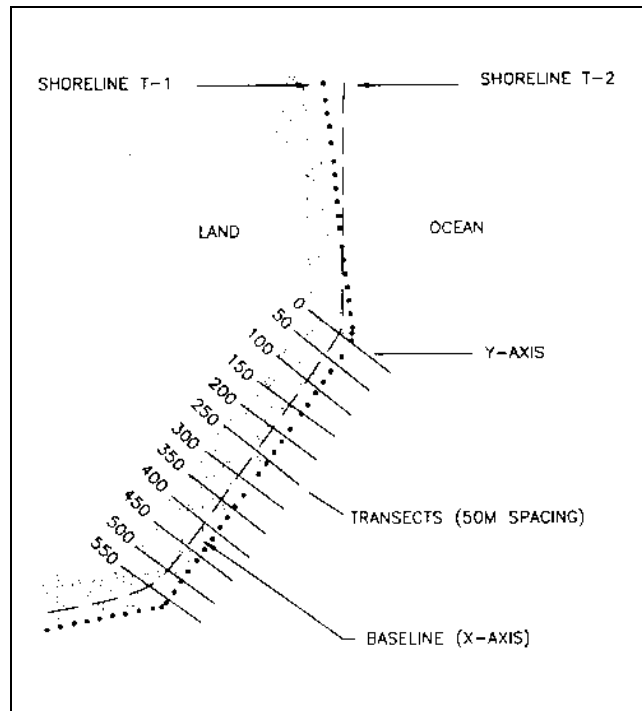

Figure 5-27. Coastline is divided into segments based on the general orientation of the shoreline

$$s = \sqrt{\frac{\sum_{i=1}^n (x_i - \bar{x})^2}{n - 1}} \quad (5-2)$$

The maximum shoreline movement represents the difference in the most landward and seaward position. It also represents the end points for shoreline change inclusive of all the data sets. Identifying areas of maximum shoreline movement is useful with beach fill projects.

(c) Comparisons of calculated shoreline change rates are generally grouped by specific time periods or by alongshore segments (i.e. geomorphic features representing spatial trends). A case example, shown in Figure 5-28, of distinctive spatial shoreline trends is located in northern New Jersey, where the shoreline is part of a barrier spit complex including an active compound spit (Sandy Hook, New Jersey to Sea Bright), barrier peninsula (Sea Bright to Monmouth Beach), and a headland coastline (Monmouth Beach to Shark River Inlet) (Gorman and Reed 1989).

(9) Interpretation of shoreline change.

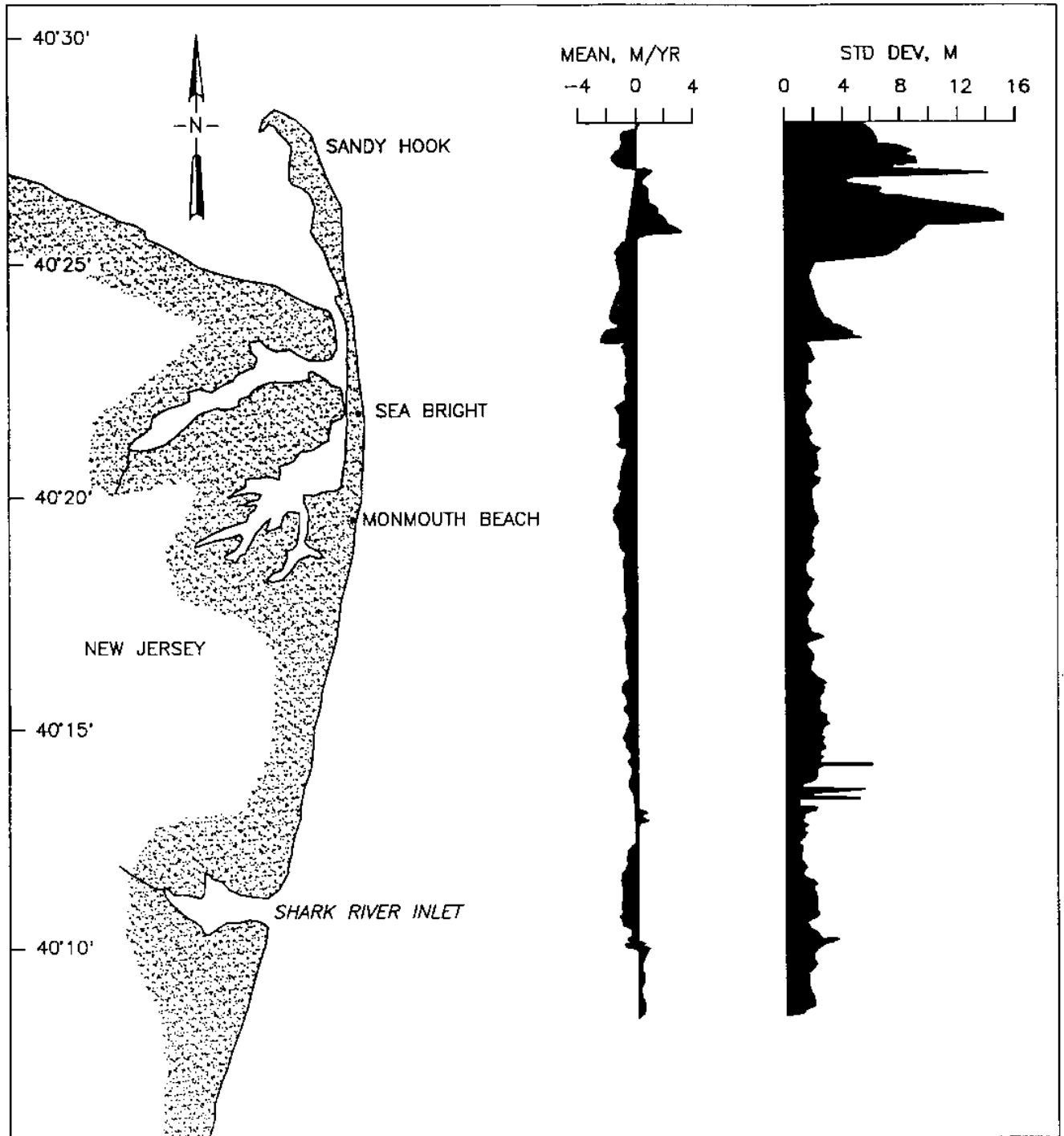

Figure 5-28. Distinctive spatial shoreline trends along the northern New Jersey shore

(a) Historical shoreline positions have been recognized as a primary data source for quantifying rates of erosion and accretion. Coastal scientists, engineers, and planners often use this information for computing rates of shoreline movement for shore protection projects, determining a project rate of retreat for shore protection, estimating the magnitude and direction of sediment transport, monitoring engineering modifications to a beach, examining geomorphic variations in the coastal zone, establishing coastal erosion set-back lines, and verifying numerical shoreline change models.

(b) Relevant published studies that quantify shoreline movement for key U.S. coastlines are listed in Table 5-14. Usually, the alongshore shoreline is subdivided based on geomorphic features or human modifications (Anders, Reed, and Meisburger 1990; Gorman and Reed 1989). Another criterion used is to identify end points of shoreline segments where little or no net change was measured (Knowles and Gorman 1991). Recently, a blocking technique was used by Byrnes and Hiland (1994) to evaluate the spatial shoreline trends based on areas with similar direction of change producing variable-length shoreline cells.

f. Beach and nearshore profiles.

(1) Background. Evaluation of continuous and repeated beach and nearshore profiles documents the entire active profile envelope and provides a complete picture of the response of the profile to coastal processes. Because storms are an important factor in coastal sedimentary processes, it is important to assess profile changes after major storm events. Collecting field data as soon as possible after storms and comparing these profiles to the most recent pre-storm ones provides a measure of areas of erosion and accretion and the volume changes that have occurred.

(2) Accuracy criteria.

(a) Elevation resolution for a typical project profile is estimated to be about 0.012 m at a maximum range.

(b) As described in section 5-3, water bodies are often surveyed by a sled which is towed by boat out into the water from about +1.5 m to closure depth. This results in overlap between the onshore rod survey and the sled survey to assure that the two systems are recording the same elevations. If offshore surveys are conducted by boat-mounted echosounder, overlap with the rod survey is usually not possible.

(c) Comparison of sled/Zeiss systems and boat echosounder systems has shown sled surveys to have a higher vertical and horizontal accuracy (Clausner, Birkemeier, and Clark 1986). Echosounder surveys are limited by the indirect (acoustic) nature of the depth measurement, the effects of water level variations and boat motions, and the inability to survey the surf zone due to wave action and tidal range. In summary, there are quality advantages in using sled surveys offshore, but operational limitations are imposed by wave heights, water depth, seafloor obstructions, and the maneuvering needed to keep the sled on line.

(d) All profile surveys must be referenced to the same elevation datum. This can especially be a problem when echosounder surveys are conducted by different agencies or contractors over time (Figure 5-29). Meticulous field notes must be kept to record datums, corrections, equipment calibrations, and other information that is needed for accurate data reduction.

(3) Analysis techniques.

Table 5-14
Selected Shoreline Movement Studies

Author	Location	Method
Byrnes and Hiland 1994	Cumberland-Amelia Islands, Georgia/Florida	Georeferenced in GIS
Gorman and Reed 1989	Northern New Jersey	Cartographic techniques, map overlays
Anders, Reed, and Meisburger 1990	South Carolina	Cartographic techniques, map overlays
McBride et al. 1991	Louisiana	Georeferenced in GIS
Morton 1979	Texas	Map overlays
Everts, Battley, and Gibson 1983	Cape Henry - Cape Hatteras	Map overlays
Leatherman 1984	Maryland	Metric mapping

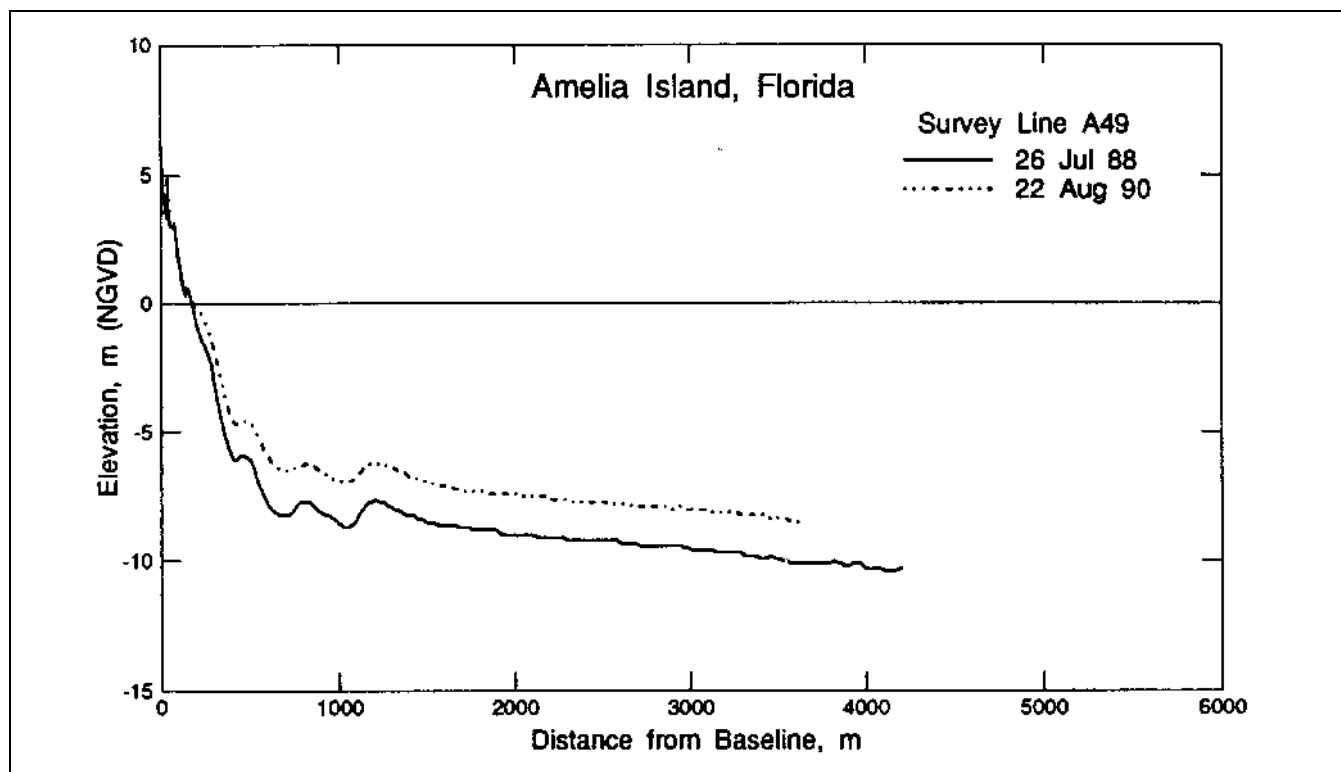

Figure 5-29. Example of vertical offset between two offshore profile surveys due to use of different datums

(a) Profile analysis reveals the variability in cross-shore elevation patterns and volume change that occur along a profile line. With multiple profiles, the along-shore variability in profile response is documented. With a long-term monitoring program, seasonal variations and the impact of storms are identified.

(b) Profile data recorded in the field are typically processed in the laboratory using computer software packages. The CERC Interactive Survey Reduction Program (ISRP) plots and compares both spatial and temporal profile sets (Birkemeier 1984). The program allows the plotting of field data sets at various scales and vertical exaggerations from baseline (X) and elevation (Y). An unlimited number of profiles can be plotted on a single axis to compare profile change and determine profile envelopes and closure areas. The most frequent analysis uses profiles of successive dates to compare morphology and volume changes. CERC's Beach Morphology and Analysis Package (BMAP) contains many analysis tools, including generation of synthetic profiles (Sommerfeld et al. 1994).

(c) Vertical elevations of important morphologic features found on profiles are usually referenced to

NGVD or another datum specified for a particular project. All horizontal distances should be measured from the designated baseline position, preferably located behind the primary dunes for safety (i.e., survival during major storms). Volume change calculations can be made from the baseline to a common distance offshore (usually the shortest profile) to normalize volume change between survey dates. Profile volume calculations should be based on the minimum distance value. Survey distances offshore often vary in length due to the wave conditions at the time of the sled survey.

(4) Profile survey applications.

(a) General. Interpretation of beach response to coastal processes can be done with geometric and volumetric comparison of beach profile sets. If the profile sets cover a long period, information on both the cross-shore and alongshore evolution of a coastline can be made (i.e., dunes versus seawalls, position of the berm crest, and closure depth). Several types of beach parameters can be measured from profile data, including the width of the subaerial beach, location and depth of the inner bar, and beach and nearshore profile slope. Comparisons between successive profiles can be used to quantify

shoreline position change, volumetric change, and seasonal profile response. Numerous studies (Hands 1976, Wright and Short 1983) have documented the cyclic nature of beach topography in response to seasonal shifts in the local wind and wave climate. In addition to normal effects, profile surveys can also be used to measure change caused by short-term episodic events (Chiu 1977; Savage and Birkemeier 1987).

(b) Linear Measurements. Selected parameters can be used to define cross-shore morphologic features within a study area. General location and limits of features in the beach and nearshore zone used for linear profile computations are shown in Figure 5-30.

- The most variable beach parameter is beach width, which is usually measured between the base of the dune and mean low water (mlw).
- Beach slope can be calculated between the base of the dune and mlw.

- The zone from mlw out to the nearshore slope break is generally considered as the area where the nearshore slope is computed.
- Alongshore changes of the inner bar position are a useful guide of the surf zone breaker height and bottom slope. The inner bar position is measured from 0.0 m (NGVD) to the bar crest (Hands 1976; Gorman et al. 1994).
- If shoreline change or aerial photography maps are not available, shoreline position can be estimated from the location of a specified elevation point on a profile line. An approximate position of the high-water shoreline should be selected based on local tidal information. A common elevation referenced for this type of analysis is 0.0 (NGVD) (USAE District, Jacksonville 1993). However, this position constitutes a highly variable measure due to the movement of the bar or ridge and runnel features along the lower beach.

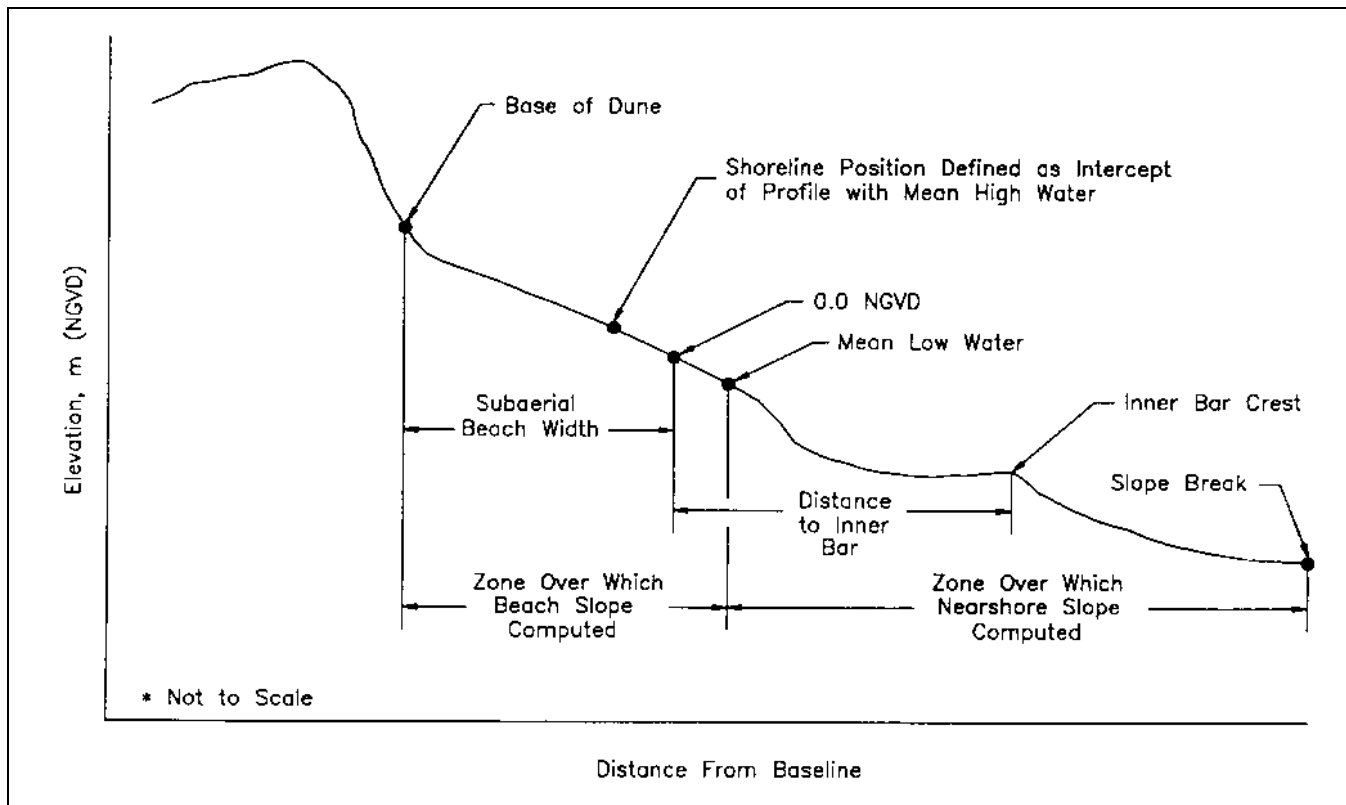

Figure 5-30. Features within the beach and nearshore zone used for linear profile computations

(c) Volumetric analysis. Volume analysis of most long-term profile data sets will provide temporal and spatial documentation of profile volume change due to overwash processes, storm impacts, and nearshore bar evolution. Computer programs such as ISRP can provide quantitative information on profile shape change and volume of sediment gained or lost between two or more survey dates (Birkemeier 1984). Figure 5-31 shows an analysis of the Ocean City, Maryland, beach fill project. Based on volume computations, this type of analysis provided a time history of fill placed on the beach and the subsequent readjustment of the fill material. Typical profile response showed erosion on the dry beach above NGVD and accretion in the nearshore area after fill placement as the shoreface adjusted to a new equilibrium profile.

(d) Seasonality. Winter erosional beach profiles can be characterized as having concave foreshore areas and a well-developed bar/trough in the nearshore. During fair-weather summer conditions, the bar moves landward and welds onto the foreshore, producing a wider berm with a lower offshore bar and flatter trough. Profile response to the seasonal cycle is a function of storm frequency and intensity. When trying to determine the extent of the profile envelope, at least 1 year of data should be used. The profile envelope of an East Coast beach system is shown in Figure 4-29, with the characteristic winter and summer berm profiles. Because there are frequent local storm surges during the winter months, the berm and dune crest often retreat; however, in most areas sand recovery takes place during the summer months as littoral material moves onshore and longshore. Along a well-defined ridge and runnel system, significant sediment exchange can occur between the summer and winter months (Figure 3-21).

Great Lakes beaches also display summer/winter patterns, often characterized by considerable bar movement (Figure 4-30). At some Great Lakes sites, the mobile sand layer is quite thin and seasonal patterns can be difficult to detect (Figure 5-32).

g. *Bathymetric data.*

(1) Introduction. Analysis and examination of topographic and bathymetric data are fundamental in many studies of coastal engineering and geology. When assembling bathymetric surveys from a coastal area, a researcher is often confronted with an immense amount of data which must be sorted, checked for errors, redisplayed at a common scale, and compared year by year or survey by survey in order to detect whether changes in bottom

topography have occurred. This section will discuss three general aspects of geographic data analysis:

- Processing of bathymetric data using mapping software.
- Applications and display of the processed results.
- Error analyses.

(2) Bathymetric data processing - data preparation and input.

(a) Most historical bathymetric data sets consist of paper maps with printed or handwritten depth notations (Figure 5-33). Occasionally, these data are available on magnetic media from agencies like NOAA, but often a researcher must first digitize the maps in order to be able to perform computer-based processing and plotting. If only a very limited region is being examined, it may be more expedient to contour the charts by hand. The disadvantage of hand-contouring is that it is a subjective procedure. Therefore, one person should be responsible for all of the contouring to minimize variations caused by different drawing styles or methods of smoothing topographic variations.

(b) In order to be able to manipulate 3-dimensional (X, Y, and Z) data, display and plot it at different scales, and compare different data sets, it is necessary to use one of the commercial mapping programs such as GeoQuest Corporation's Contour Plotting System 3 (CPS-3) or Golden Software's Surfer. These are comprehensive packages of file manipulation, mapping algorithms, contouring, and 2- and 3-dimensional display. Their use requires considerable training, but they are powerful analysis tools.

(c) The raw data used by mapping programs consists of data in X-Y-Z form. As described in the previous section, if the data are derived from old maps, they must first be corrected to a common datum, map projection, and coordinate system. For small files, visual examination of the data may be worthwhile in order to inspect for obviously incorrect values. Because it is laborious to review thousands of data points, simple programs can be written to check the raw data. For example, if all the depths in an area are expected to be between +2.0 and -12.0 m, the program can tag depths that are outside this range. The analyst can then determine if questionable points are erroneous or represent genuine but unexpected topography. The X and Y points should typically

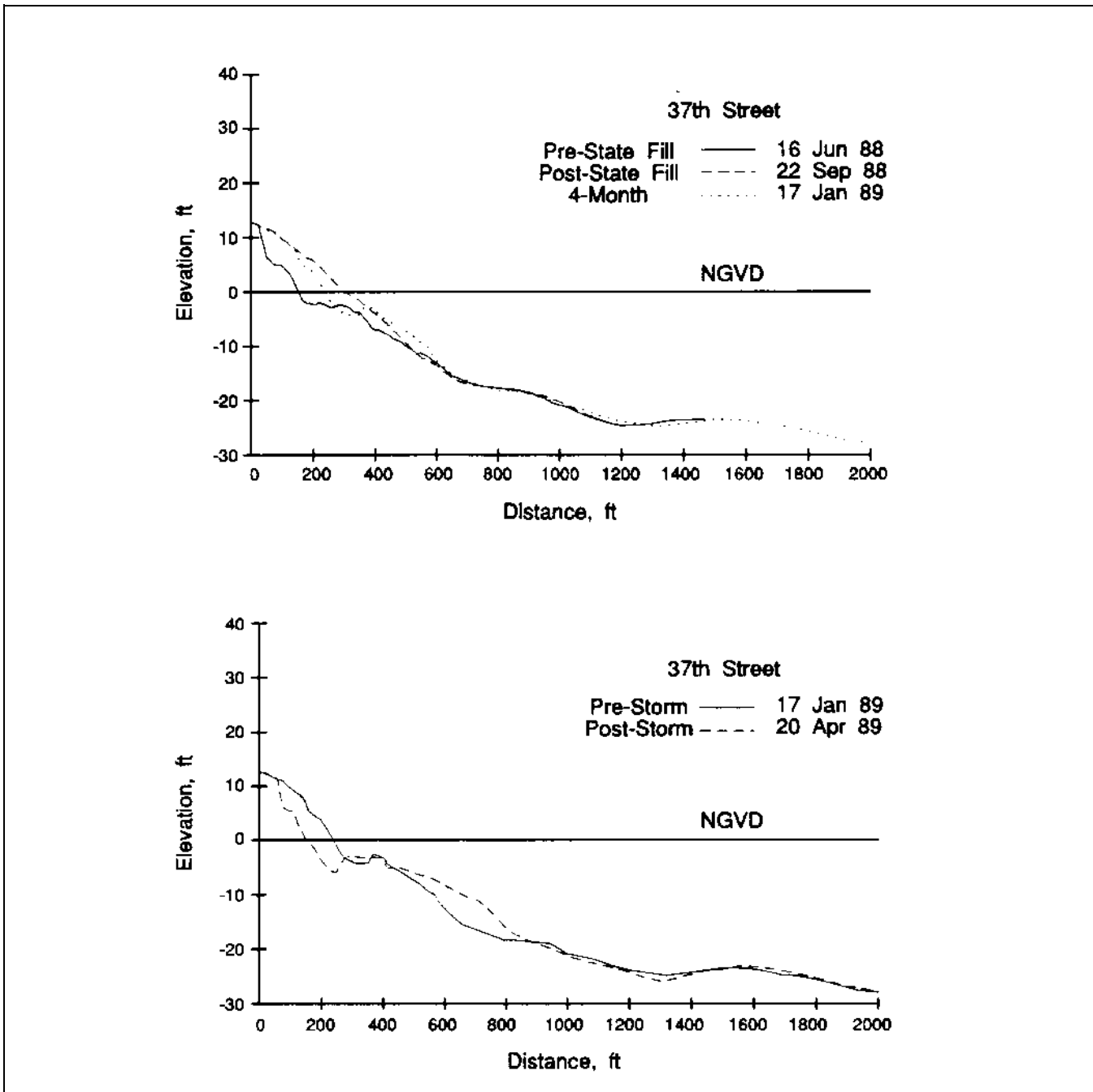

Figure 5-31. Analysis of the Ocean City, MD, beach fill project. Upper plot shows profile before beach fill and the large quantity of sand placed on the beach during the summer of 1988. Lower plot shows erosion of the upper profile during a storm in early 1989. Sand from the beach moved offshore to the region between 400 and 900 ft from the benchmark

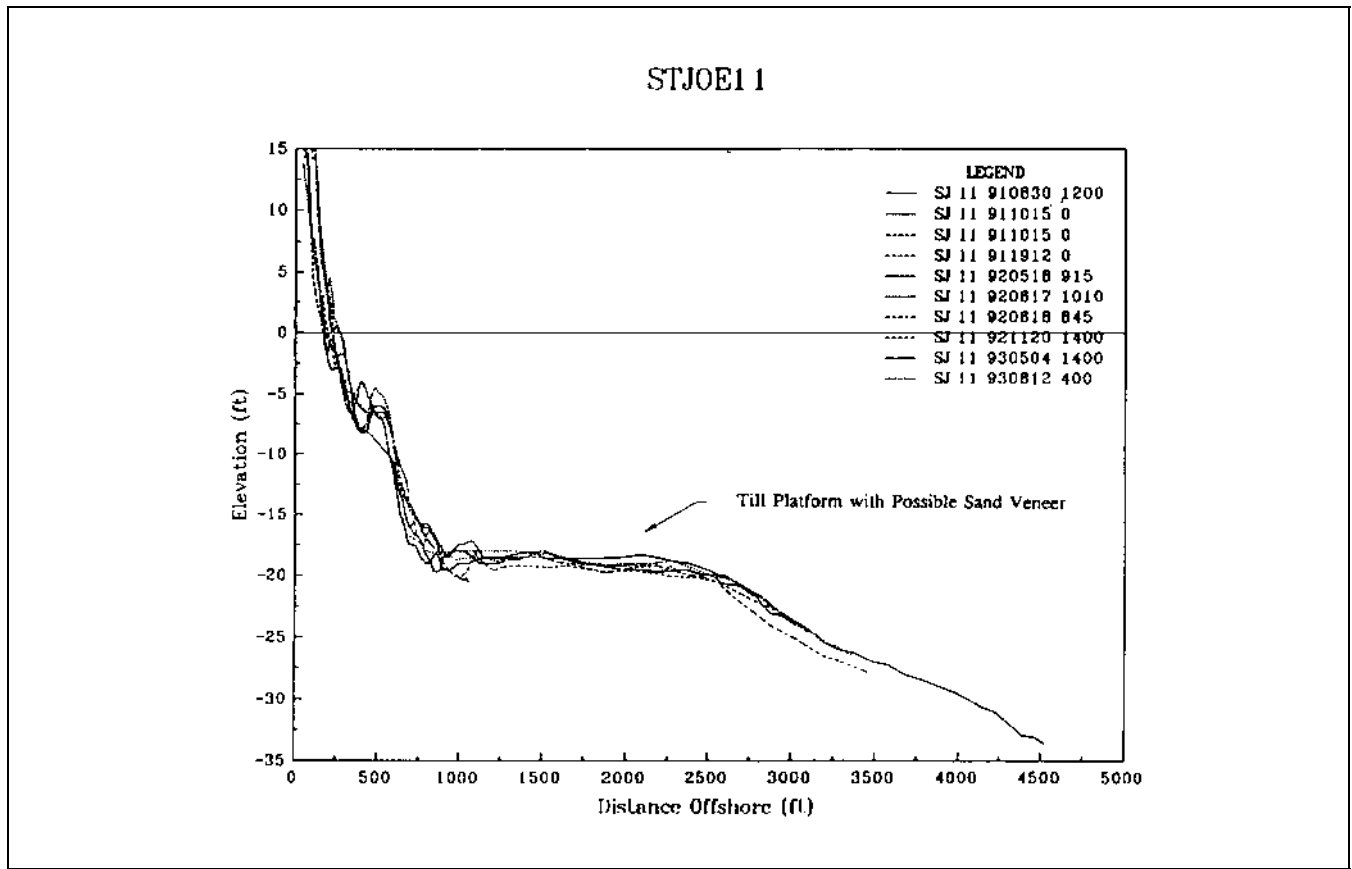

Figure 5-32. Profile envelope from St. Joseph, Michigan. The horizontal platform from 1,000 to 2,500 ft offshore is an exposed till surface. Most shoreface sand movement appears to be confined to the zone landward of the till platform, although it is likely that thin veneers of sand periodically cover the till (previously unpublished CERC data)

represent Cartesian coordinates, which is the case if the original maps were based on State Plane coordinates. X and Y points which are latitude and longitude must be converted by the program.

(3) Gridding operations.

(a) Gridding is a mathematical process in which a continuous surface is computed from a set of randomly distributed X, Y, and Z data.¹ The result is a data structure (usually a surface) called a grid. Note that the grid is an artificial structure. It is based on the original data, but the grid points are not identical to the original survey points (Figures 5-34 and 5-35). Because the grid represents the surface that is being modeled, the accuracy of

the grid directly affects the quality of any output based on it or on comparisons with other grids generated from other data sets. Computing a grid is necessary before operations such as contouring, volume calculation, profile generation, or volume comparison can be performed. The advantage of a grid is that it allows the program to manipulate the surface at any scale or orientation. For example, profiles can be generated across a channel even if the original survey lines were not run in these directions. In addition, profiles from subsequent surveys can be directly compared, even if the survey track lines were very different.

(b) Several steps must be considered as part of the grid generation. These include:

- Selecting a gridding algorithm.
- Identifying the input data.
- Specifying the limits of the grid coverage.

¹ Examples in this section were prepared using CPS-3 mapping software from GeoQuest Corporation. However, the overall concepts and procedures discussed are general, and other software packages perform similar functions.

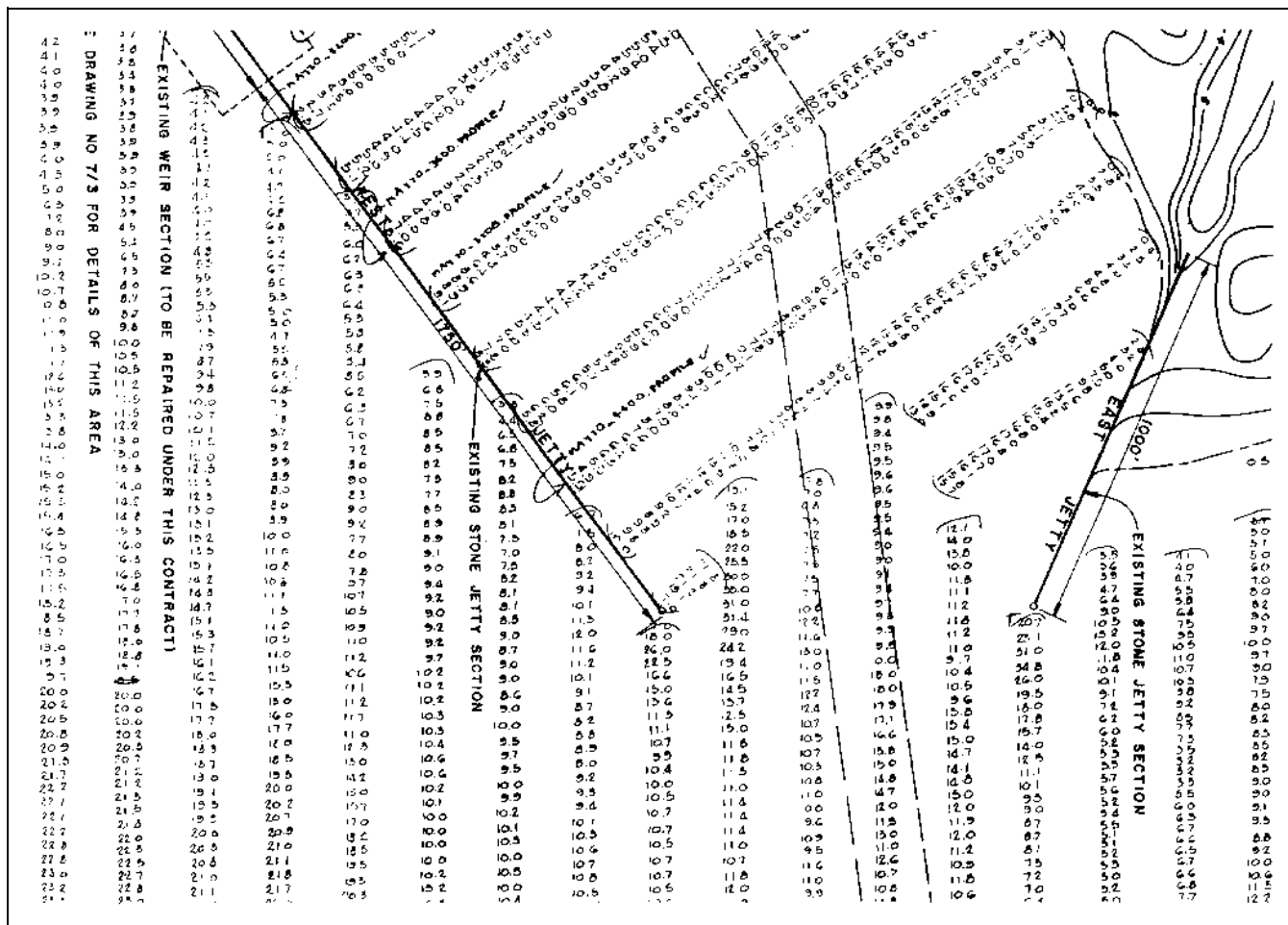

Figure 5-33. Example of a hand-annotated hydrographic map from a Florida project site. The depths have been corrected for tide and are referenced to mlw. (Map courtesy of USAE District, Mobile)

- Specifying gridding parameters.
- Specifying gridding constraints.
- Computing the grid.

The choice of a gridding algorithm can have a major effect on the ultimate appearance of the grid. Software companies have proprietary algorithms which they claim are universally superior. Often, however, the type or distribution of data determines which procedure to use, and some trial and error is necessary at the beginning of a project. Because a computed grid is an artificial structure, often it is a subjective evaluation whether one grid is “better” than another. For subaerial topography, an oblique aerial photograph can be compared with a computer-generated 3-dimensional drawing oriented at the same azimuth and angle. But for a subaqueous seafloor, how can a researcher really state that one surface does not

look right while another does? Even comparing a gridded surface with a hand-contoured chart is not a valid test because hand-contouring is a very subjective procedure.

(4) The fundamental challenge of a gridding algorithm is to estimate depth values in regions of sparse data. The procedure must attempt to create a surface which follows the trend of the terrain as demonstrated in the areas where data do exist. In effect, this is similar to the trend-estimating that a human performs when he contours bathymetric data by hand. The other challenge occurs in complex, densely sampled terrains. The algorithm must fit the surface over many points, but genuine topographic relief must not be smoothed away! Along a rocky coast, for example, high pinnacles may indeed project above the surrounding seafloor.

(a) Gridding algorithms include:

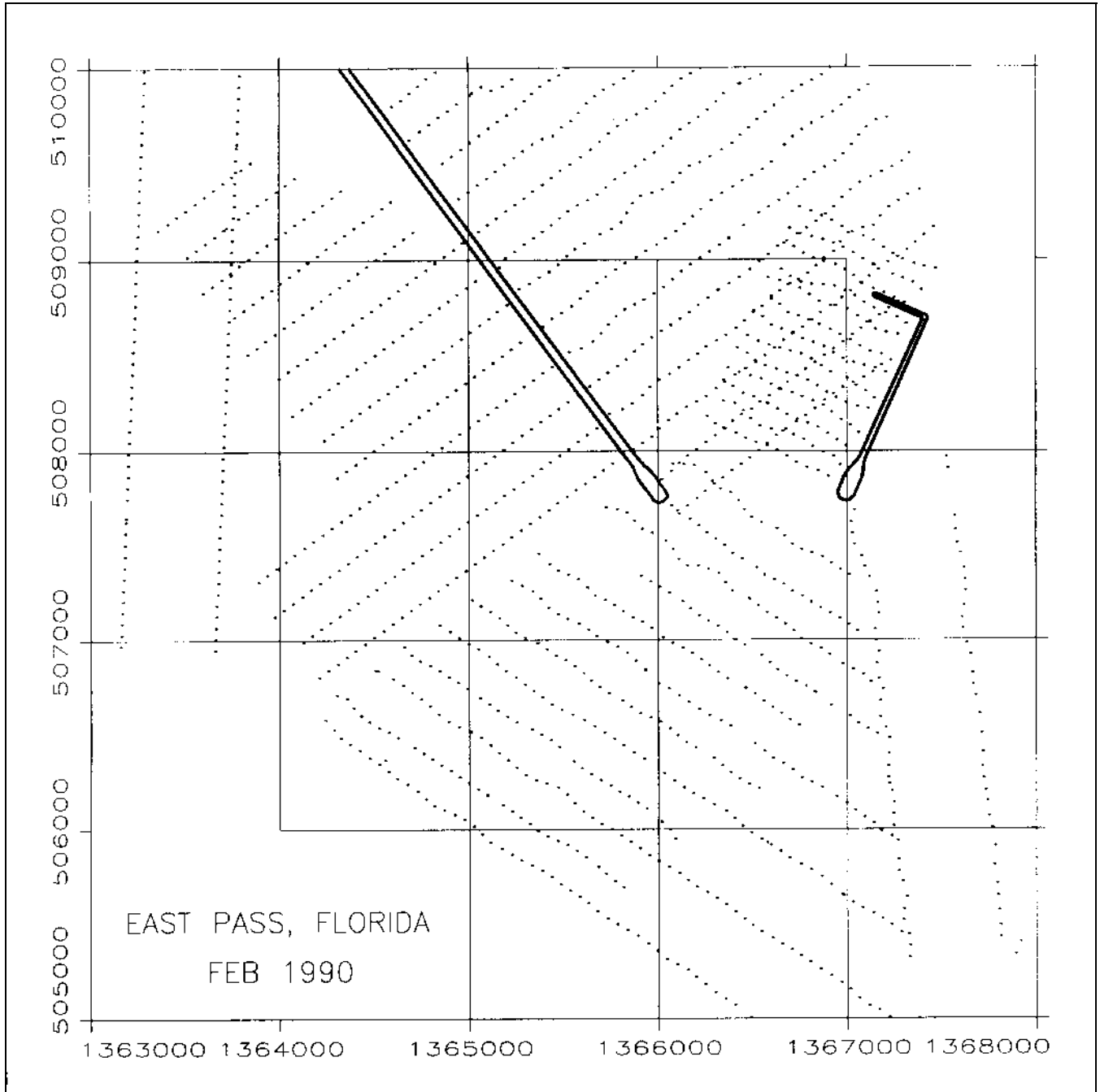

Figure 5-34. Digitally collected hydrographic data from a Florida project site. The track lines are obvious, as is the fact that the soundings are not uniformly distributed throughout the survey area. (Data courtesy of USAE District, Mobile)

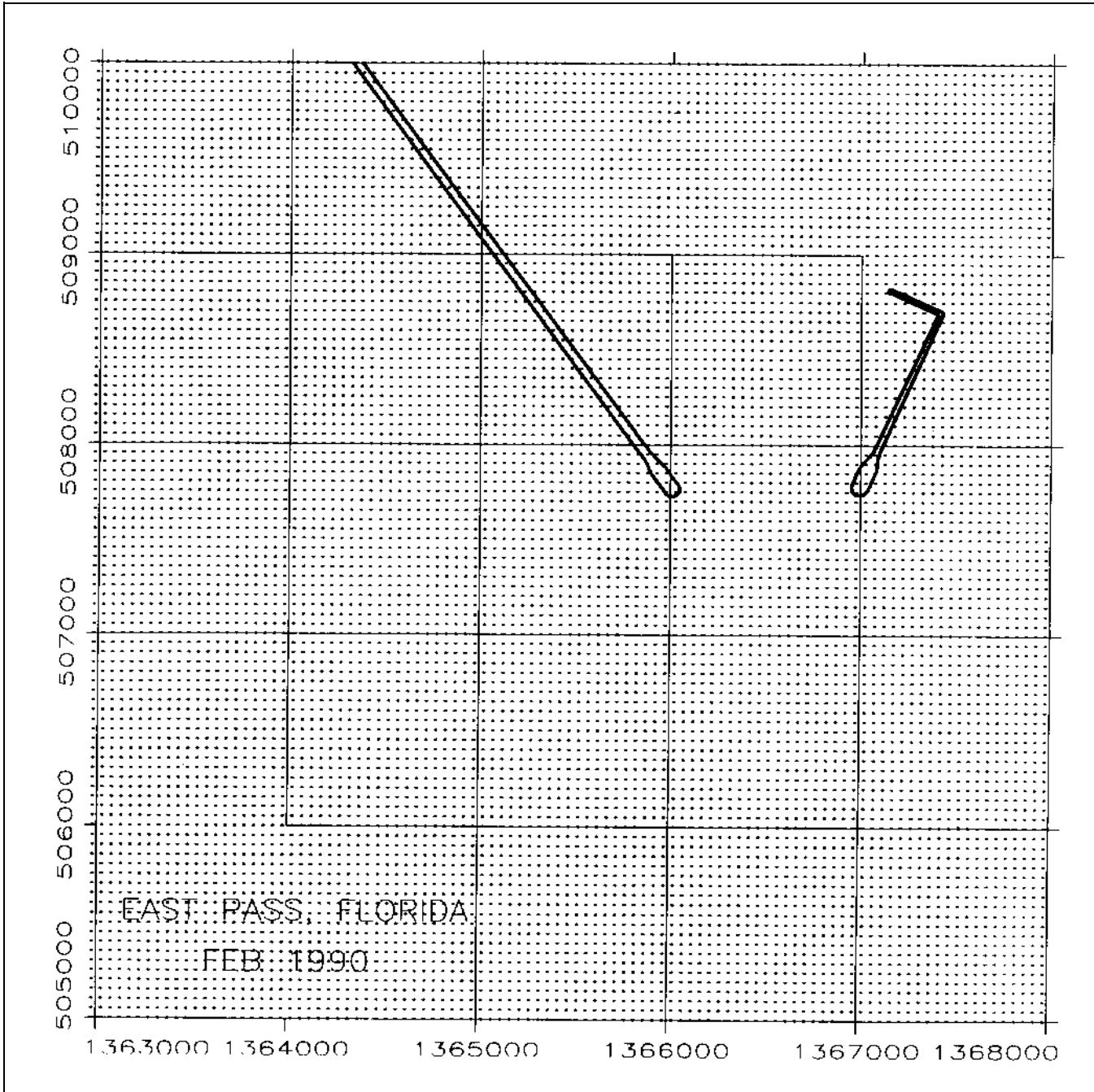

Figure 5-35. Surface grid computed by CPS-3 based on the data shown in Figure 5-31. The nodes are uniformly spaced compared with the locations of the original soundings. A grid does not necessarily have to be square, although this is common

- Convergent (multi-snap) (CPS-3 software).
- Least squares with smoothing.
- Moving average.
- Trend.
- Polynomial.

The convergent procedure often works well for bathymetric data. It uses multiple data points as controls for calculating the values at nearby nodes. The values are blended with a distance-weighting technique such that close points have more influence over the node than distant points. Several iterations are made, with the first being crude and including many points, and the final being confined to the closest points. The least-squares method produces a plane that fits across several points near the node. Once the plane has been calculated, the Z-value at the node is easily computed. The reader must consult software manuals to learn the intricacies of how these and other algorithms have been implemented.

(b) Another important parameter that must be chosen is the gridding increment. This is partly determined by the algorithm chosen and also by the data spacing. For example, if survey lines are far apart, there is little purpose in specifying closely spaced nodes because of the low confidence that can be assigned to the nodes located far from soundings. In contrast, when the original data are closely spaced, large X- and Y-increments result in an artificially smoothed surface because too many data points influence each node. Some programs can automatically calculate an increment that often produces good results.

(4) Applications and display of gridded data.

(a) Contouring of an area is one of the most common applications of mapping software (Figure 5-36). Not only is this faster than hand-contouring, but the results are uniform in style across the area and precision (i.e. repeatability) is vastly superior.

(b) The power of mapping programs is best demonstrated when analyzing different surveys. If at all possible, the different data sets should be gridded with the same algorithms and parameters in order that the results be as comparable as possible. Difficulty arises if earlier surveys contain much sparser data than later ones. Under these circumstances, it is probably best if the optimum grid is chosen for each data set. A simple application is

to plot a suitable contour to demonstrate the growth over time of a feature like a shoal (Figure 5-37). Computation of volumetric changes over time is another application (Figure 5-38). This can graphically demonstrate how shoals develop or channels migrate.

(c) Volumetric data can be used to estimate growth rates of features like shoals. As an example, using all 18 of the 1,000-ft squares shown in Figure 5-37, the overall change in volume of the East Pass ebb-tidal shoal between 1967 and 1990 was only 19 percent (Figure 5-39). Although the shoal had clearly grown to the southwest, the minor overall increase in volume suggests that considerable sand may have eroded from the inner portions of the shoal. In contrast, when plotting the change in volume of nine selected squares, the growth over time was 600 percent. This underscores how critically numerical values such as growth rates depend upon the boundaries of the areas used in the calculations. The user of secondary data beware!

(5) Error analysis of gridded bathymetry.

(a) A crucial question is how much confidence can a researcher place on growth rates that are based on bathymetric or topographic data? Unfortunately, in the past many researchers ignored or conveniently overlooked the possibility that error bars may have been greater than calculated trends, particularly if volumetric computations were based on data of questionable quality.

(b) This section outlines a basic procedure that can be used to calculate volumetric errors provided that estimates of the vertical (ΔZ) accuracy are available. If ΔZ values are unavailable for the specific surveys, standard errors of ± 0.5 , ± 1.0 , or ± 1.5 ft, based on the class of the survey, can be used (Table 5-4). For coastal surveys close to shore, this method assumes that errors in positioning (ΔX and ΔY) are random and have insignificant effect on the volumes compared with possible systematic errors in water depth measurements, tide correction, and data reduction. For older historic surveys, positioning error may be important, requiring a much more complicated analysis procedure. Positioning accuracy of hydrographic surveys is discussed in EM 1110-2-1003 and NOAA (1976).

(c) The error in volumetric difference between surveys can be estimated by determining how much the average depth in each polygon changes from one survey to another and then calculating an average depth change over all polygons. Maximum likely error (MLE) is:

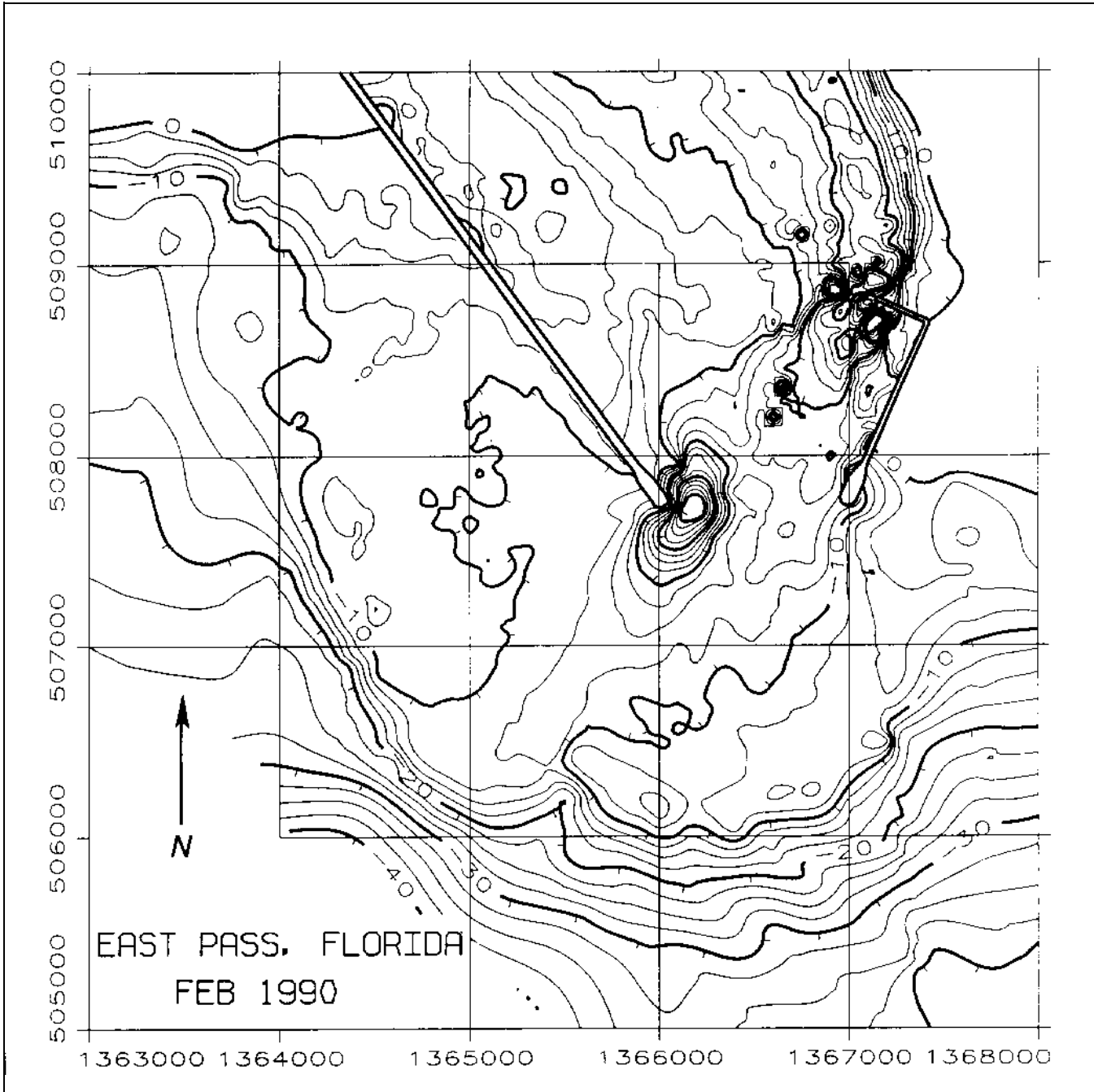

Figure 5-36. Contoured bathymetry of the same area shown in Figures 5-34 and 5-35. Depths in feet below mlw

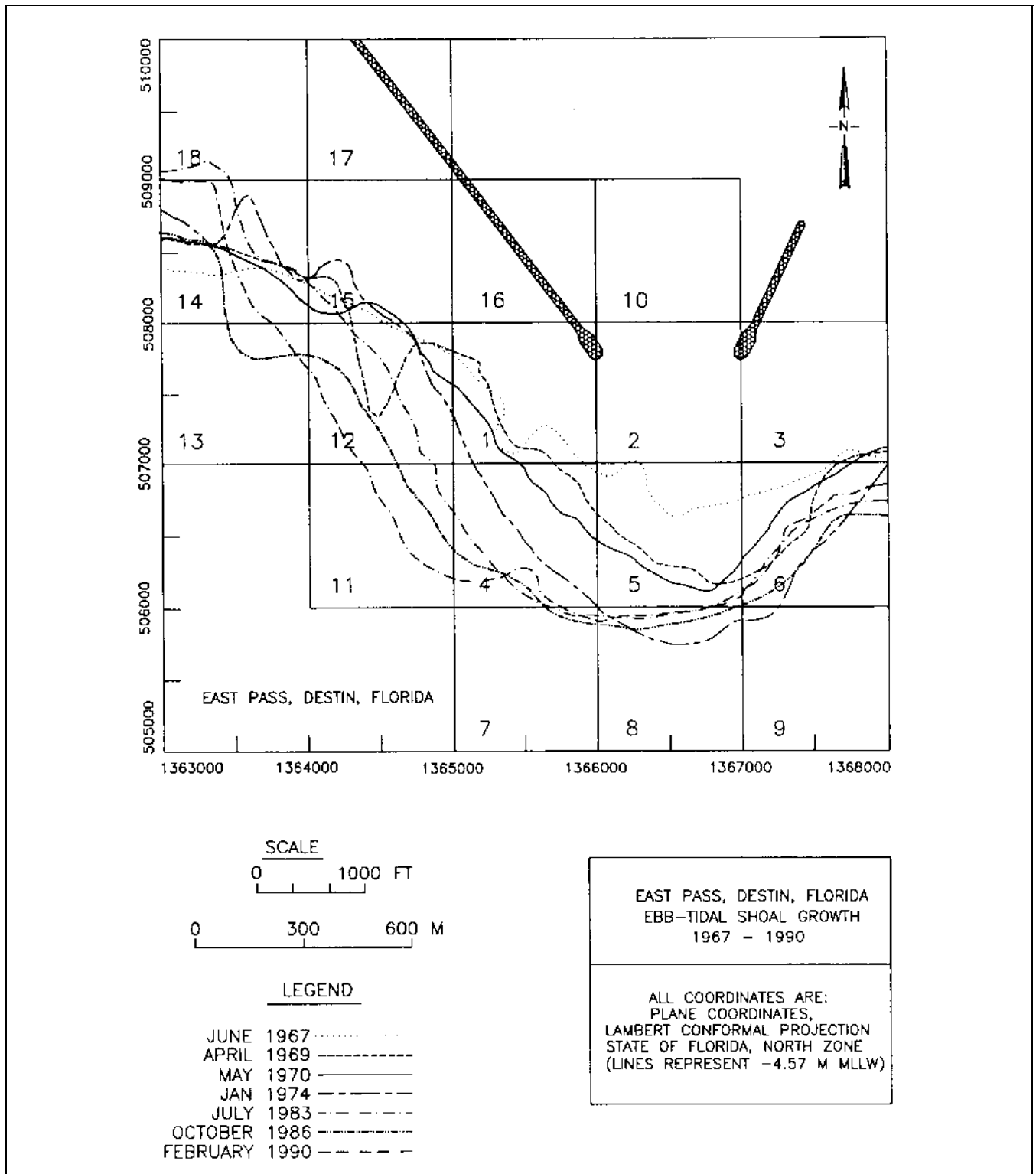

Figure 5-37. Overall growth of an ebb-tidal shoal over 24 years is shown by the advance of the 15-ft isobath. This isobath was chosen because it represented approximately the mid-depth of the bar front. The 1000-ft squares are polygons used for volumetric computations (Morang 1992a)

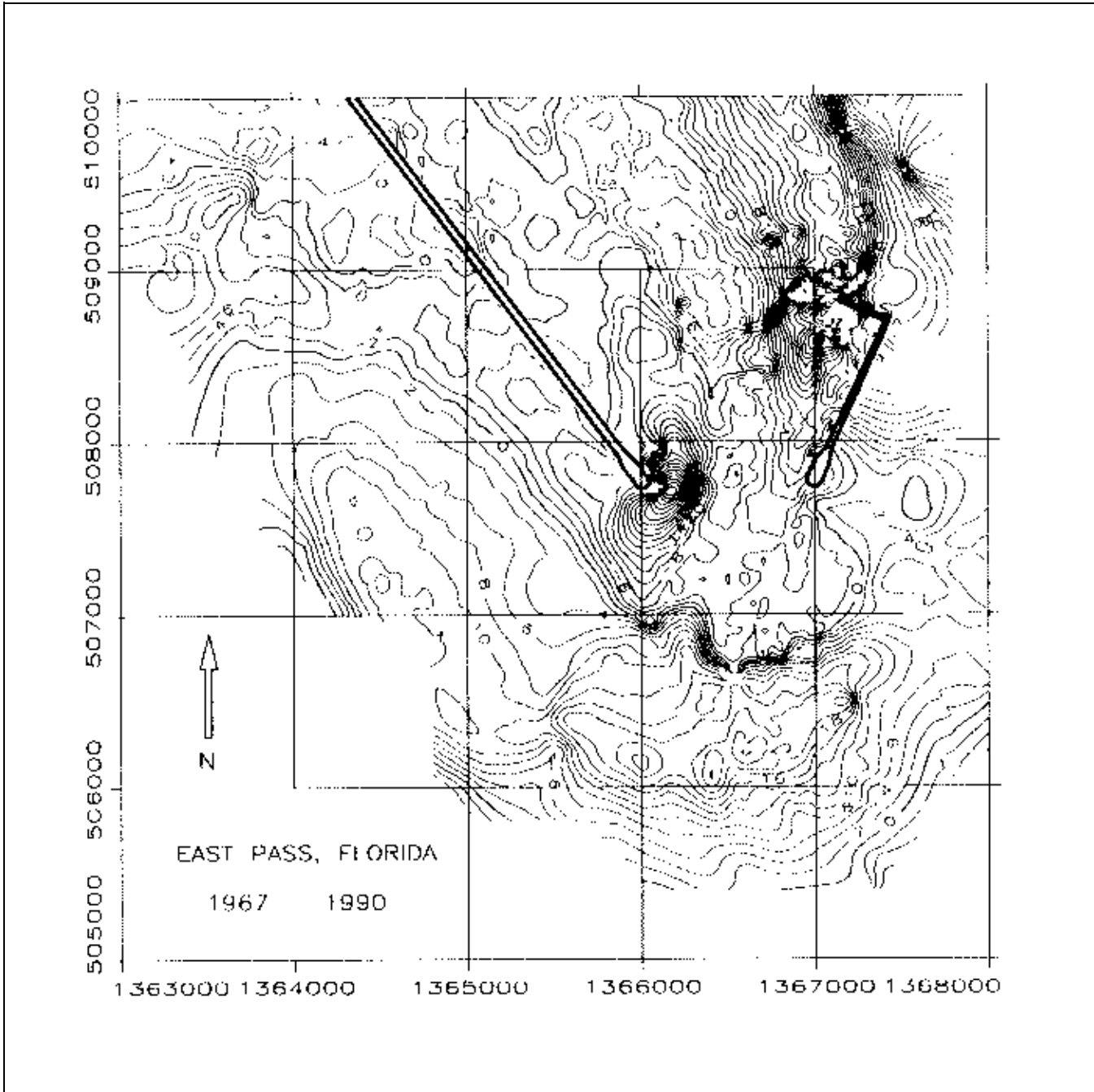

Figure 5-38. Isopach map showing overall changes in bottom configuration between 1967 and 1990 at East Pass, Florida. Red contours represent erosion, while green represent deposition (both colors at 2-ft interval). The black contour line represents the zero line (no erosion or deposition). The migration of the channel thalweg to the east is obvious, as is the growth of scour holes at the jetties. Map computed by subtracting June 1967 surface from February 1990 surface. (Morang 1992a)

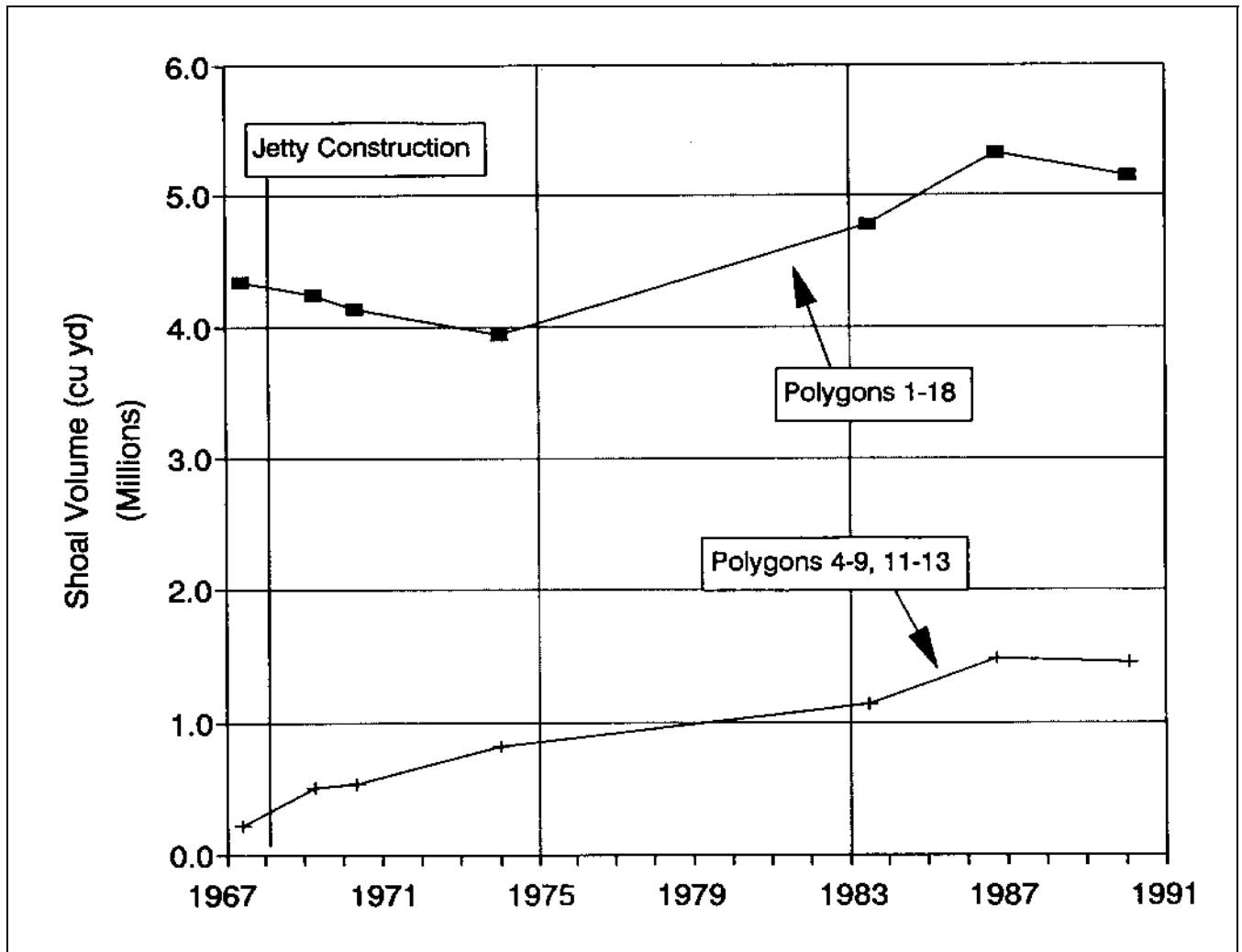

Figure 5-39. Growth of the ebb-tidal shoal at East Pass, FL. Areas used in the computations are shown in Figure 5-37. Growth rates are dramatically different depending upon which polygons are included in the volumetric computations

$$\frac{2 \times \Delta Z}{\Delta Z_{ave}}$$

For example, if $\Delta Z = 0.15$ m and $\Delta Z_{ave} = 1.0$ m, then MLE is:

$$\frac{0.30 \text{ m}}{1.00 \text{ m}} = 0.30 = 30 \text{ percent}$$

Note that this is for a Class 1 survey; many offshore surveys are not conducted under such tight specifications. If $\Delta Z = 0.46$ m for Class 3, then MLE for the above

example = 91 percent. Under these circumstances, it becomes meaningless to say that an area has changed in volume by a certain amount ± 91 percent.

(d) The size of the polygons used in the calculation of ΔZ_{ave} can influence the MLE. A particular polygon that covers a large area may average ΔZ of only 0.3 or 0.6 m, but water depths from spot to spot within the polygon may vary considerably more. Therefore, by using smaller polygons, ΔZ will typically be greater and MLE correspondingly less. However, the use of smaller polygons must be balanced against the fact that positioning errors (ΔX and ΔY) become correspondingly more significant.

(e) More research is needed to quantify errors associated with various types of offshore surveys and to identify how these errors are passed through computed quantities. They must *not* be neglected when analyzing geologic data, particularly if management or policy decisions will be based on perceived trends.

h. Sediment grain size analyses.

(1) Introduction¹.

(a) The coastal zone is comprised of many dynamic morphologic features that frequently change their form and sediment distribution. Although a beach can display a large range of sizes and shapes, each beach is characterized by particular texture and composition representing the available sediment (Davis 1985). Textural trends alongshore and cross-shore are indicative of the depositional energy and the stability (or instability) of the fore-shore and nearshore zones.

(b) Because of natural variability in grain size distributions, a sampling scheme should adequately sample the native beach in both the cross-shore and alongshore directions. Sediment sampling needs to coincide with survey profile lines so that the samples can be spatially located and related to morphology and hydrodynamic zones. Consideration of shoreline variability and engineering structures should be factored into choosing sampling locations. A suggested rule of thumb is that a sampling line be spaced every half mile, but engineering judgment is required to define adequate project coverage. On each line, it is recommended that samples be collected at all major changes in morphology along the profile, such as dune base, mid-berm, mean high water, mid-tide, mean low water, trough, bar crest, and then 3-m intervals to depth of closure (Figure 5-40) (Stauble and Hoel 1986).

(2) Grain size analysis statistics.

(a) Sediments should be sieved using U.S. Standard sieves at 1/4-phi (ϕ) unit intervals. *Phi* (ϕ) is defined as the negative logarithm of the grain dimension in millimeters to the base 2. The equation for the relationship of millimeters to phi scale is:

$$\phi = -\log_2(d_{mm}) \quad (5-3)$$

where

d_{mm} = particle diameter in millimeters

¹ Text condensed from Gorman et al. (in preparation)

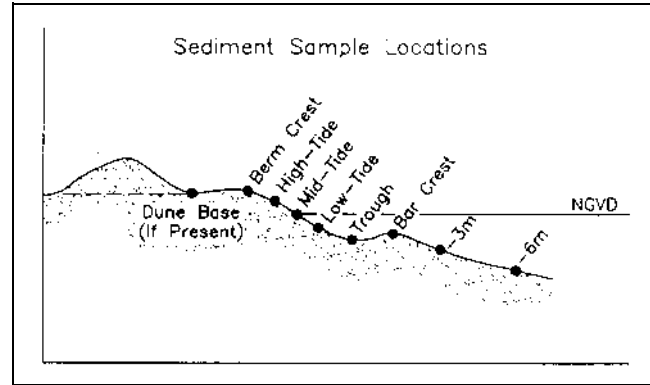

Figure 5-40. Recommended sampling locations at a typical profile line

(b) Grain-size analyses should include grain-size distribution tables, statistics and graphics of frequency, cumulative frequency and probability distribution (see "Calculation of Composite Grain Size Distribution" in the *Automated Coastal Engineering System (ACES)* of Leenknecht, Szuwalski, and Sherlock (1992) and ASTM Standard D 2487-92. Standard grain-size distribution statistics include:

- Median grain size or d_{50} - the particle size in the center of the population.
- Mean grain size or average grain size.
- Standard deviation or the spread of the distribution about the mean - defines the concept of sorting.
- Skewness or measure of symmetry of the distribution around the mean.
- Kurtosis or measure of the peakedness of the frequency distribution.

Each of these statistical parameters provides information on the grain-size distribution and its depositional environment. The mean is the most commonly used statistic to characterize the average grain size of the distribution. The median value can be read directly off a cumulative curve and is near-normal to the mean in a normal distribution but differs if the distribution is non-normal. The sorting gives the spread of the various grain sizes in the distribution. A *well-sorted distribution* contains a limited range of grain sizes and usually indicates that the depositional environment contains a narrow range of sediment sizes or a narrow band of depositional energy. A *poorly sorted distribution* contains a wide range of grain sizes

indicating multiple sources of sediment or a wide range of energies of deposition. *Positive skewness* indicates an excess of fine grain sizes, whereas *negative skewness* indicates an excess of coarser grain sizes. The *kurtosis* measures the ratio between the sorting in the tails of the distribution relative to the central portion (sand size) of the distribution.

(c) These statistical parameters are commonly calculated by two different methods. The *graphic method* uses specific percentiles of a grain-size distribution (i.e., 5, 16, 25, 50, 75, 84, and 95) that are read from graphical data plots (Folk 1974) or can be calculated from sieve data. The values are used in simple equations to produce the approximate statistical parameters. Phi values are used to calculate these parameters, and only the mean and median should be converted to millimeter values. The *method of moments* uses the entire grain-size distribution values to mathematically produce the statistical parameters (Friedman and Sanders 1978). This procedure is more accurate, but was time-consuming to calculate before the use of computers; for this reason, older sediment statistical data are commonly based on the Folk graphic method. Additional consideration for the user of grain size statistics are listed below:

- The graphical and moment methods are *not* directly comparable. Because sediment statistics for many projects have historically been calculated by the graphic method, for uniformity it may be best to continue using the graphic method.
- The graphic and moment procedures have advantages and disadvantages. These are summarized in Table 5-15.

- Note that calculated statistical parameters are only an indication of the characteristics of the sediment in the field. The user must not assume that the whole population has exactly these characteristics.
- Accurate sediment grain-size statistics are dependent on adequate sample size. Recommendations for field sampling have been listed in Table 5-9.

The following sections list equations and provide verbal description of sediment grain-size parameters for both the graphic method and the method of moments. The equations are identical to those used in the USACE ACES software (Leenknecht, Szuwalski, and Sherlock 1992).

(d) Mean grain size. Table 5-16 lists formulas and descriptive criteria for classifying the mean grain size of a sample.

(e) Standard deviation (sorting). The standard deviation or measure of sorting uses the equations and verbal descriptors listed in Table 5-17.

(f) Skewness. The skewness or measure of symmetry shows excess fine or coarse material in the grain-size distribution. Table 5-18 lists equations used for the graphic method and method of moments, with the range of verbal descriptors.

(g) Kurtosis. Kurtosis or measure of the peakedness of the grain-size distribution relates sorting of the tails compared to sorting of the central portion of the distribution. The equations listed in Table 5-19 are used for the graphic method, which centers around graphic kurtosis $K_G = 1.00$, and the method of moments, which centers around the moment kurtosis $k = 3.00$. The range of

Table 5-15
Comparison of graphic and moment procedures for calculating grain-size statistics

Method	Advantages	Disadvantages
Graphic	Can be calculated from almost all distribution data Resistant to sampling and laboratory errors (i.e., a single faulty sieve does not invalidate the calculated statistics) Can use open-ended samples (more than 5 percent of sample weight on either tail)	Does not use all data from all sieves
Moment	Uses formula that has a greater number of parameters Uses data from all sieves	Parameters have to be established in laboratory Parameters should be important to the application; otherwise may be more than needed or useful Open-ended distributions (more than 5 percent of sample in either tail) must be excluded, therefore losing the geologic information that these samples might reveal

Table 5-16
Mean Grain Size

Graphic Mean, M:

$$M = \frac{\phi_{16} + \phi_{50} + \phi_{84}}{3} \quad (5-6)$$

Where: ϕ_n = grain size of nth weight percentile in phi units

Moment Mean, \bar{x} :

$$\bar{x} = \frac{\sum f m_{\phi}}{100} \quad (5-7)$$

Where: f = frequency weight percent
 m_{ϕ} = midpoint of size class

Descriptive Criteria:

Grain size (mm)	Grain size (Phi)	Wentworth Classification
1.00 - 2.00	0.0 - -1.0	Very Coarse Sand
0.50 - 1.00	1.0 - 0.0	Coarse Sand
0.25 - 0.50	2.0 - 1.0	Medium Sand
0.125 - 0.25	3.0 - 2.0	Fine Sand
0.0625 - 0.125	4.0 - 3.0	Very Fine Sand

Table 5-17
Sample Standard Deviation (Sorting)

Graphic Sorting, σ :

$$\sigma = \frac{\phi_{84} - \phi_{16}}{4} + \frac{\phi_{95} - \phi_5}{6.6} \quad (5-8)$$

Moment Sorting, σ :

$$\sigma = \left[\frac{\sum f (m_{\phi} - \bar{x})^2}{100} \right]^{1/2} \quad (5-9)$$

Descriptive Criteria:

Sorting Range (Phi)	Description of Sorting
<0.35	Very well sorted
0.35 - 0.50	Well sorted
0.50 - 0.71	Moderately well sorted
0.71 - 1.00	Moderately sorted
1.00 - 2.00	Poorly sorted
2.00 - 4.00	Very poorly sorted
> 4.00	Extremely poorly sorted

Table 5-18
Sample Skewness

Graphic Skewness, S_k :

$$S_k = \frac{\phi_{16} + \phi_{84} - 2(\phi_{50})}{2(\phi_{84} - \phi_{16})} + \frac{\phi_5 + \phi_{95} - 2(\phi_{50})}{2(\phi_{95} - \phi_5)} \quad (5-10)$$

Moment Skewness, S_k :

$$S_k = \frac{\sum f (m_o - \bar{x})^3}{100 \sigma^3} \quad (5-11)$$

Descriptive Criteria:

Skewness Range	Description of Skewness
+1.0 to +0.3	Very fine-skewed
+0.3 to +0.1	Fine-skewed
+0.1 to -0.1	Near-symmetrical
-0.1 to -0.3	Coarse-skewed
-0.3 to -1.0	Very coarse-skewed

Table 5-19
Sample Kurtosis

Graphic Kurtosis, K_G :

$$K_G = \frac{\phi_{95} - \phi_5}{2.44 (\phi_{75} - \phi_{25})} \quad (5-12)$$

Descriptive Criteria for Graphic Method:

Graphic Kurtosis Range	Description of Kurtosis
< 0.67	Very platykurtic (flat)
0.65 to 0.90	Platykurtic
0.90 to 1.11	Mesokurtic (normal distribution)
1.11 to 1.50	Leptokurtic
1.50 to 3.00	Very leptokurtic
> 3.00	Extremely leptokurtic (peaked)

Moment Kurtosis, k :

$$k = \frac{\sum f (m_o - \bar{x})^4}{100 \sigma^4} \quad (5-13)$$

Descriptive Criteria for Moment Method:

Moment Kurtosis Range	Description of Kurtosis
< 3.00	Platykurtic (flat)
Around 3.00	Mesokurtic (normal distribution)
> 3.00	Leptokurtic

verbal descriptors of peakedness is based on the platykurtic (flat) curve versus the leptokurtic (peaked) curve, with a mesokurtic curve as normal.

(3) Composite sediments¹. Combining samples from across the beach can reduce the high variability in spatial grain size distributions on beaches (Hobson 1977). Composite samples are created by either physically combining several samples before sieving or by mathematically combining the individual sample weights to create a new composite sample on which statistical values can be calculated and sediment distribution curves generated. Samples collected along profile sub-environments can be combined into composite groups of similar depositional energy levels and processes as seen in Figure 5-41. Intertidal and subaerial beach samples have been found to be the most usable composites to characterize the beach and nearshore environment area. After comparing several composite groups, Stauble and Hoel (1986) found that a composite containing the mean high water, mid-tide, and mean low water gave the best representation of the

foreshore beach. They found that nearshore sample composite sediment distributions changed little over time. This suggests that active sorting and sediment transport occur on the active beach face and bar area and that nearshore sands remain uniform over time.

(4) Seasonal variability. There can be a wide variability in grain size distribution on a native beach between winter high wave periods and summer fair weather periods. This variability can be a problem in choosing a representative native beach. The winter grain size distribution usually is coarser and more poorly sorted than the summer distribution (due to the higher frequency of storms in the winter). The concept of the seasonal beach cycle is based on the frequency of storm-induced erosion and fair weather accretion. Extreme events, such as hurricanes that occur in the summer or early fall, as well as mild winters with few extratropical storms, may cause perturbations on the seasonal cycle. A sampling strategy to characterize the seasonal variability should take into account the recent local storm climate.

¹ Text adapted from Stauble (1994).

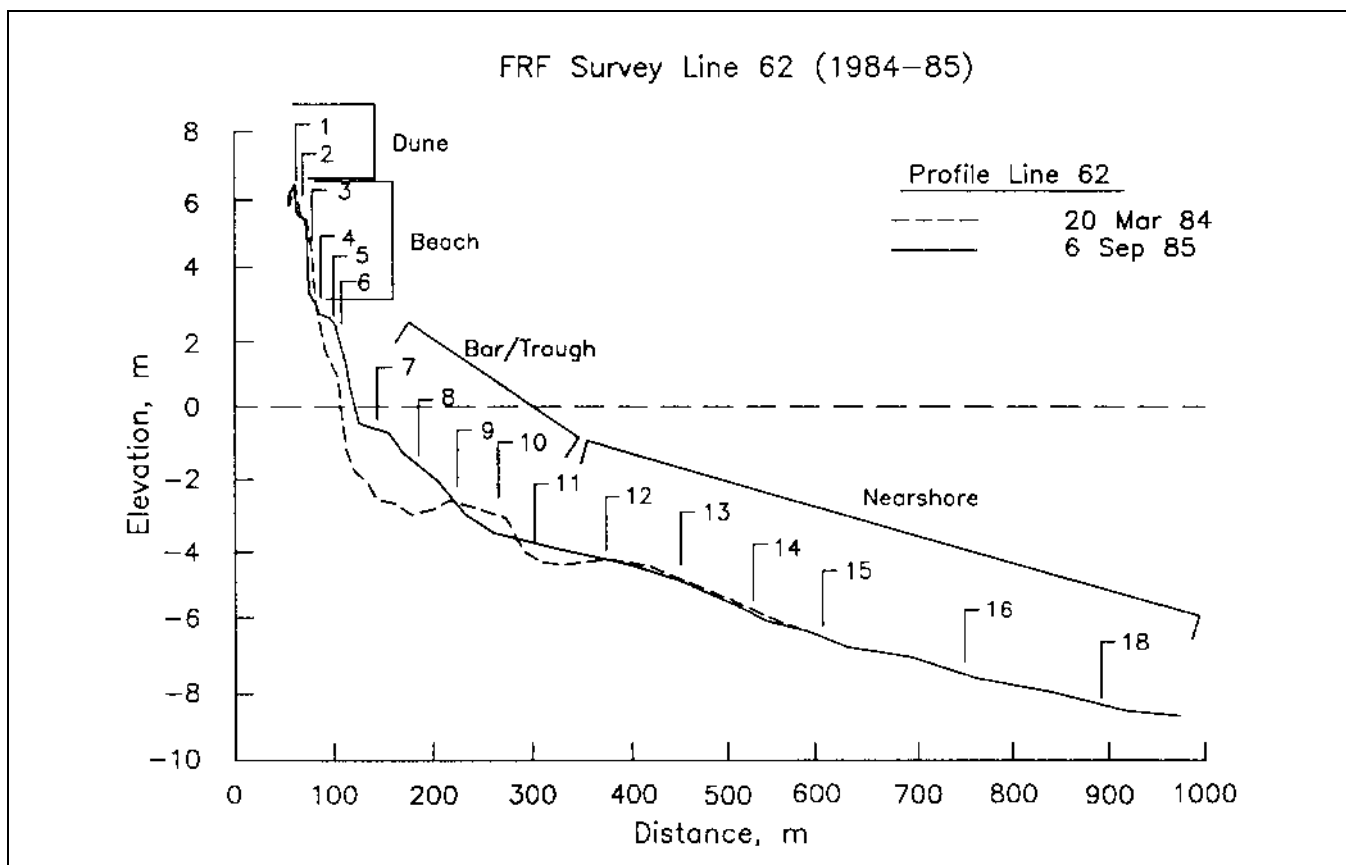

Figure 5-41. Combination of samples into composite groups of similar depositional energy levels and processes (example from CERC Field Research Facility, Duck, NC)

(5) Sediment data interpretation.

(a) Grain size distributions of beach sediment vary with both time and space. Because of the daily wave and tidal influence on sediment deposition on the beach foreshore, swash processes create an ever-changing foreshore sediment distribution. The use of composites helps to simplify the analysis and interpretation of these changes. The bar/trough area also experiences a wide variety of energy conditions and thus displays a variety of grain size distributions over time. Dune and nearshore grain size distributions have less variability due to the lower energy conditions that affect these areas. The dune is primarily influenced by wind transport, which limits change to the finer grain sizes except under extreme wave conditions, when the waves actually impact on the dune. The nearshore zone is dependant on regional and local coastal processes.

(b) An example of composite grain size distribution curves for the beach at the Field Research Facility, Duck, NC, is shown in Figure 5-42. Using the entire distribution from coarse to fine sizes shows the changes in size classes for various depositional regimes. The beach group composite is illustrated because it displayed the greatest variability in distribution during the study. The bimodal nature of the distribution can be seen, with increases in the coarse mode fraction after storms or when samples on the foreshore contained granule-size lag deposits. The coarsest material was present early in the study period during the winter storm period. Later, the distribution shifted to the finer mode except during July, 1985, when a coarse fraction was present. Swash processes of uprush and backwash are the principal transport mechanism in this area.

(c) Spatial variation along a beach is more complex. Analysis of grain size data from six profiles at Ocean City, MD, shows the influence of beach fill placement and storm processes. Figure 5-43 shows the change in mean grain size of the foreshore composites (high tide, mid-tide and low tide samples) for the six profiles located along the central section of the beach fill project. Between the pre- and post-fill sampling, the means became finer and the volume of the profile increased on five of the six locations as the fill was placed. Storm processes caused the foreshore means to become coarser, but a return to finer foreshore mean was found with storm recovery. From these studies, a general trend to coarser (and more poorly sorted) sediment grain size distribution occurred after high wave conditions. High wave power values and, to a lesser extent, wave steepness values

correlated with times when the means became coarse. The shift to finer means occurred as the wave parameters decreased.

i. Coastal data display and analysis using Geographic Information Systems.

(1) Definitions.

(a) Geographic Information Systems - known as GIS - are information-oriented computerized methods designed to capture, store, correct, manage, analyze, and display spatial and non-spatial geographic data (Davis and Schultz 1990). Using computer-based technology, GIS methodology has revolutionized many of the traditional, manual methods of cartographic analysis and display. GIS is an outgrowth of many existing technologies: cartography, spatial analysis, remote sensing, computer mapping, and digital database management.

(b) GIS is based on the manipulation of spatial data. The term *spatial data* refers to "any data or information that can be located or tied to a location, regardless of the original form (tabular, map, image, or some other form). Essentially, spatial data possess attributes or characteristics that are linked to location." (Davis and Schultz 1990).

(2) Components.

(a) Many of the data manipulation operations required to analyze bathymetric data, aerial photographs, and historic maps can be accomplished with GIS. Five major components of GIS include:

- Geographic database.
- Software.
- Hardware.
- User interface.
- Support for equipment and structure (people, organization, training).

(b) The major functions of GIS include:

- Collection.
- Storage.
- Retrieval.

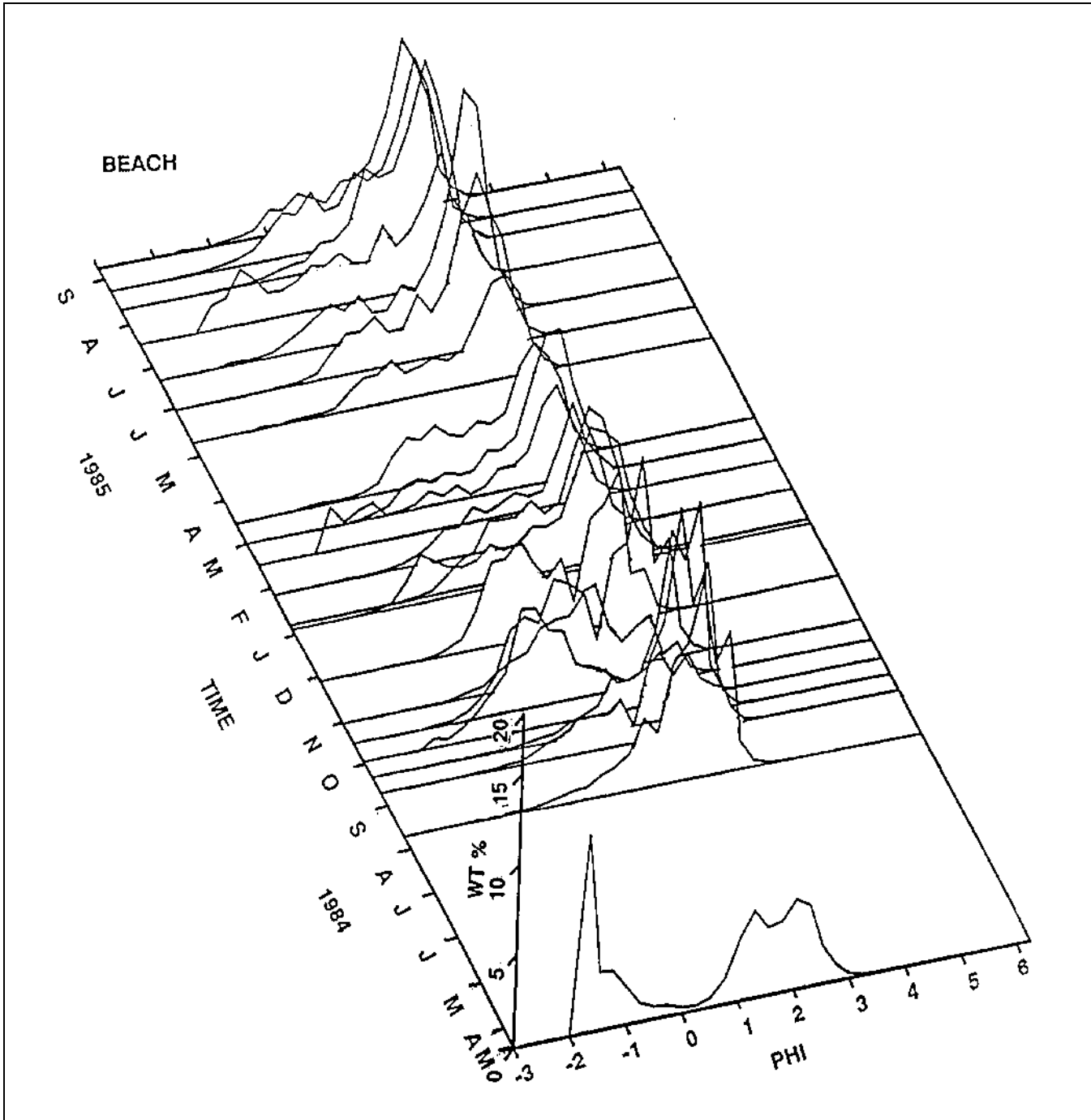

Figure 5-42. Plots of beach composite grain size distribution curves over time from the CERC Field Research Facility at Duck, NC

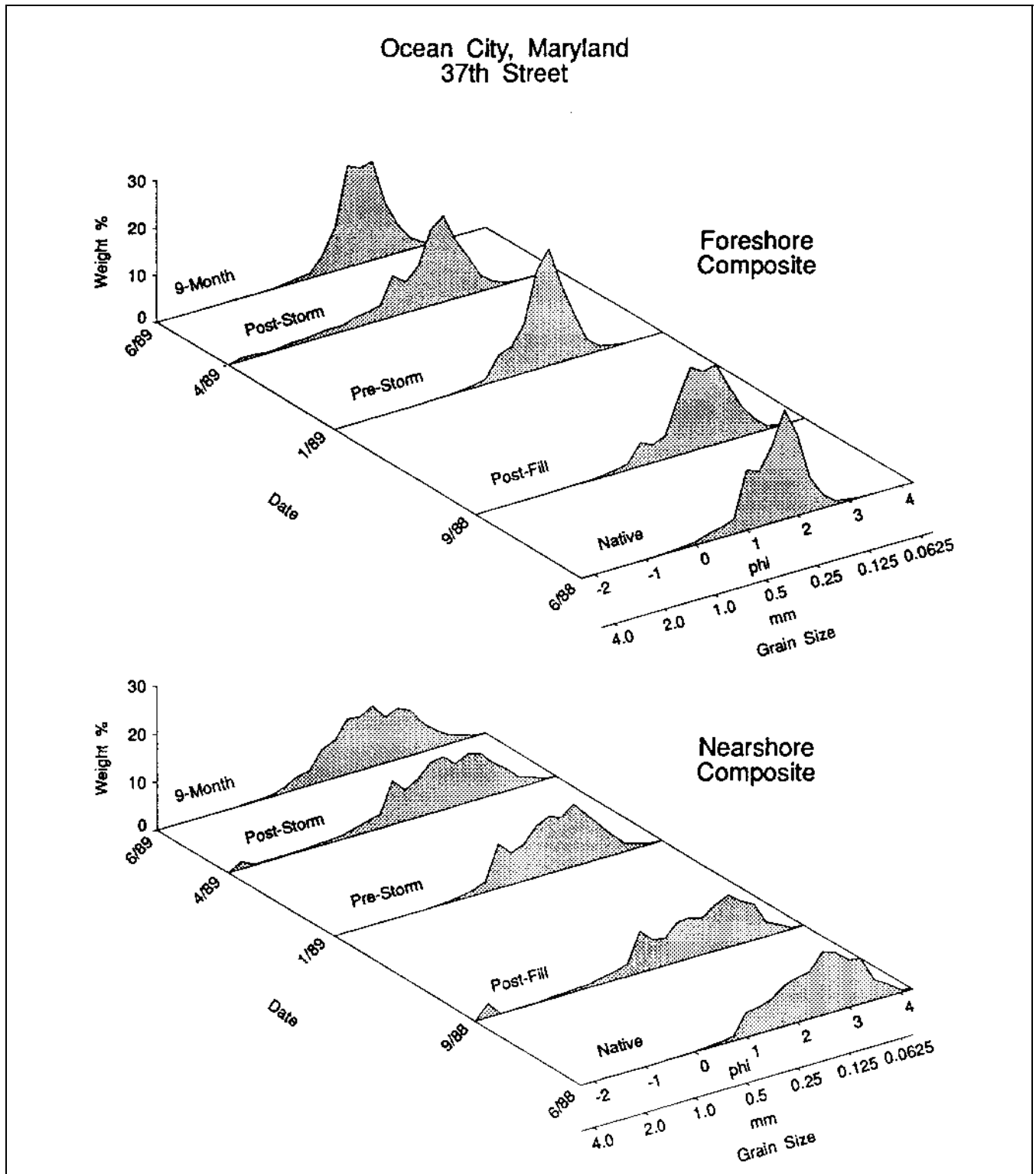

Figure 5-43. Change in mean grain size of the foreshore composites (high tide, mid-tide, and low tide samples) for six profiles located along the central section of the beach fill, Ocean City, MD

- Transformation.
- Analysis.
- Modelling.
- Display or output.

(c) The key operations that accompany the above functions are:

- Data capture and entry.
- Database management.
- Data manipulation, correction, and analysis.
- Reporting and map production.

(d) Although initially GIS was considered a subset of remote sensing and cartography, it has grown in recent years into a discipline with its own theories, approaches, techniques, and interests. The topic is too complex to cover in detail in this manual, and the reader is urged to refer to the pertinent literature. A readable primer (containing an extensive bibliography and glossary) is presented by Davis and Schultz (1990). More detailed coverage of GIS concepts and discussion of ARC/INFO® software is covered in Environmental Systems Research Institute (1992).

(3) Management and use of GIS. Rapidly declining hardware costs have made GIS affordable to an increasingly wider range of agencies. In addition, many scientists and planners are realizing that GIS may be the only effective way to interpret, display, and make more understandable vast quantities of geologic and terrain data. GIS, however, is not a panacea for all of an agency's data analysis problems. Use of a GIS in an organization requires a major commitment in training, funding, and managerial skill because the technology is relatively new and unfamiliar. Most agencies must accept new procedures in archiving and organizing data, performing quality control, updating and supporting software and hardware, and assigning key personnel to training and long-term practical projects. The latter point is critical - users cannot simply sit down at a terminal, experiment with the software for a few hours, and have any likelihood of producing effective or trustworthy data products. The decision to purchase and develop a GIS should not be taken lightly!

(4) Coastal data suitable for GIS. Some uninitiated users have the impression that GIS is a magic box that can display all kinds of geologic and marine data. In theory, this may be true. In reality, cost of hardware and data management is always a limiting factor. The more data that a particular database contains, the more costly the management, maintenance, and quality control of that information. Table 5-20 summarizes some of the types of coastal data that can be included in a GIS.

(5) Data quality.

(a) It is critical that only the highest quality data, whether original discrete points or interpreted results (e.g., shorelines extrapolated from aerial photographs) be archived in a GIS. The erroneous impression has spread that GIS automatically means high quality and high accuracy. GIS has the insidious effect that the output usually looks clean and sophisticated, and large numbers of charts and summary statistics can be quickly generated.

(b) Unfortunately, recipients of computer-drawn maps are often far removed from the assumptions and corrections used to enter and analyze the original data. Table 5-21 lists a series of steps involved in creating a modern GIS map from historic field data. Data manipulation and interpretation occur at least five times between the field operation and the completed map. Users of GIS maps must be appraised of the steps and assumptions involved in analyzing their particular data. As with any form of computerized analysis, garbage for input means garbage as output.

a. Coastal data interpretation with numerical models.

(1) Introduction.

(a) The use of numerical models in assessing changes in coastal geomorphology is rapidly increasing in sophistication. Models are designed to numerically simulate hydrodynamic processes or simulate sediment response on beaches, offshore, and in inlets. Specific types include models of wave refraction and longshore transport, beach profile response, coastal flooding, and shoreline change and storm-induced beach erosion (Birke-meier et al. 1987; Komar 1983; Kraus 1990). The judicious use of prototype data and models can greatly assist the understanding of coastal processes and landforms at a study site. Because models should be tested and calibrated, field data collection or mathematical simulation of

Table 5-20
Coastal data suitable for GIS

1. Index of all available geographic coastal data
 2. Bathymetric
 - Original soundings - valuable for numerous purposes.
 - Gridded surface data - needed for volumetric computations (original data usually also retained).
 3. Shoreline position - derived from:
 - Historic maps.
 - Recent field surveys.
 - Aerial photographs - photos require interpretation by an experienced analyst.
 4. High-resolution seismic
 - Images of original records? No - too much data to store; not useable by most people without geophysical training.
 - Interpreted seismic results:
 1. Depth to reflectors.
 2. Sediment type.
 3. Channels, faults, gas, features.
 5. Side-scan sonar
 - Images of original records? No - too much data to store; not useable by most people without geophysical training.
 - Interpreted sonogram results:
 1. Geohazards - debris, pipelines, shipwrecks.
 2. Surficial sediment - rock, sand, cohesive.
 3. Bedform orientation.
 6. Surficial sediment (grab samples)
 - Mean grain size and other statistics (grain size distribution curve if possible).
 - Color - need standard nomenclature.
 - Organic content.
 - Carbonate content.
 - Engineering properties.
 7. Core data
 - Photographic image of core? No - too much data to store.
 - Image of core log? Possible.
 - Grain size distribution and statistics at various depths.
 - Depths to interfaces (boundaries).
 - Organic content and other properties at various depths.
 - Engineering properties at various depths.
 8. Oceanographic properties of the water column (temporal in nature)
 - Salinity, other seawater chemistry.
 - Currents at spot locations (temporal - vary greatly with time).
 - Suspended sediment concentration.
 9. Biological
 - Bottom type if coral or reef.
 - Species diversity.
 - Individual species counts.
 - Pollutant concentrations.
 10. Cultural (man-made) features
 - Shore protection.
 - Oil platforms, pipelines.
 - Underwater cables.
 - Piers, jetties, structures.
 - Real estate, roads, parking lots.
-

Table 5-21
Interpretation and data manipulation required to convert historic data to GIS product

1. Original structure or feature interpreted and measured by survey team in the field.
 - Field party skilful and methodical?
 - Best survey procedures used?
 - Equipment calibrated and maintained?
 2. Information recorded onto paper charts or log books.
 3. Additional interpretation occurs if data smoothed or contoured.
 4. Historic maps and field logs interpreted by analyst many years later.
 - Changes in nomenclature?
 - Unusual datums?
 - Logs or notes incomplete? in same language?
 - Logs and maps legible?
 - Determination of date (old maps often display several dates).
 5. Data translated into digital form for modern use.
 - Technician careful?
 - Appropriate corrections made for old datums or navigation coordinates?
 - Paper charts torn, stretched, or faded?
 - Adjoining maps same year? If not, use separate layers?
 - Digitizing or scanning equipment working properly?
 6. Digital data incorporated into GIS database.
 7. GIS maps (layers) interpreted by end user.
 - Data from different years correctly overlain?
 - Valid to compare data sets of greatly differing quality?
-

waves, tides, and winds at a project site is usually required.

(b) The advantage of tools like numerical models is that they can simulate phenomena only rarely observed, can generate complex and long-duration changes, and can incorporate judgements and measurements from many sources. The use of numerical models is a highly specialized skill, requiring training, an understanding of the underlying mathematics, and empirical (“real world”) experience of coastal processes. This section summarizes types of models and introduces some of their strengths and limitations.

(2) Types of models¹.

(a) Coastal experience/empirical models. This represents the process by which an understanding or intuitive feeling of coastal processes and geomorphology is adapted and extrapolated from a researcher’s experience to a

specific project. Prediction through coastal experience without the support of objective quantitative tools has many limitations, including severe subjectivity and a lack of criteria to use for optimizing projects. Complete reliance on coastal experience places full responsibility for project decisions on the judgment of the researcher without recourse to testing the “model” with alternate tools. An empirical model is always necessary before choosing a numerical model.

(b) Beach change numerical models. Figure 5-44 summarizes the time ranges and spatial coverage of numerical models used by CERC. Summaries of the capabilities of the models follow:

- Analytical models of shoreline change. These are closed-form mathematical solutions of simplified differential equations for shoreline change derived under assumptions of steady wave conditions, idealized initial shoreline and structure positions, and simple boundary conditions. Because of the many simplifications needed to obtain closed-form solutions, these models are too crude to use for design.

¹ Material in this section has been summarized from Kraus (1989).

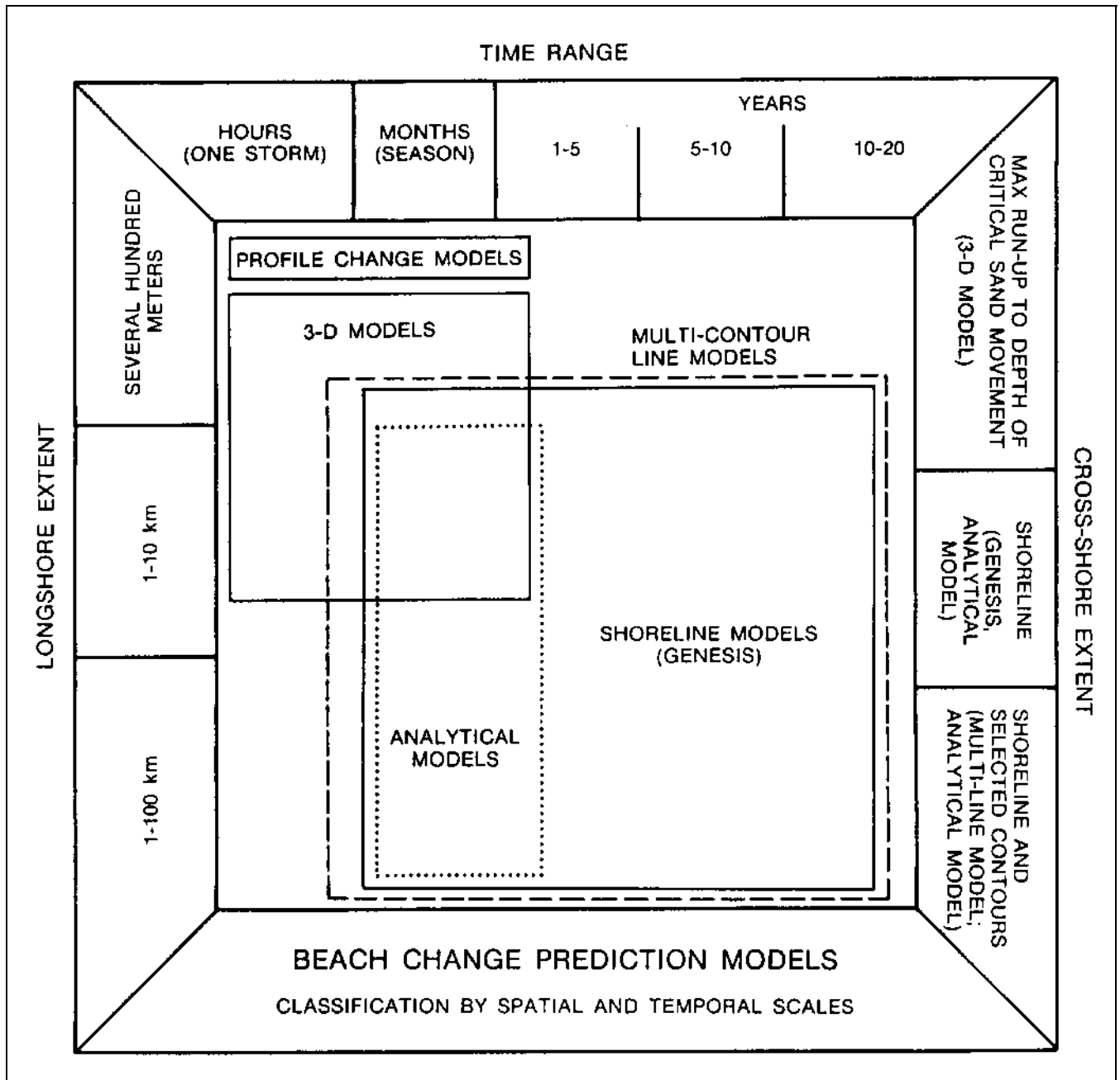

Figure 5-44. Classification of beach change models (Kraus 1989) error analysis of gridded bathymetry

- Profile change/beach erosion models. These are used to calculate sand loss on the upper profile caused by storm surge and waves. The models are one-dimensional, assuming that longshore currents are constant. Extra work needs to be done to extend their use to simulate major morphological features such as bars and berms.
- Shoreline change models. These models generalize spatial and temporal changes of shorelines analytically in response to a wide range of beach, wave, coastal structure, initial and boundary conditions. These conditions can vary with time. Because the profile shape is assumed to remain constant, onshore and offshore movement of any contour can be used to represent beach change.

These models are sometimes referred to as "one-contour line" or "one-line" models. The representative contour line is usually taken to be the shoreline (which is conveniently measured or available from a variety of sources). The GENESIS model has been extensively used at CERC (Hanson and Kraus 1989).

- Multi-contour line/schematic three-dimensional (3-D) models. These models describe the response of the bottom to waves and currents, whose intensity and geologic influence can vary both cross-shore and alongshore. The fundamental assumption of constant shoreline profile, necessary for the shoreline change models, is relaxed. The 3-D beach change models have not yet reached wide application. They have been limited by their complexity and their large requirements for computer resources and user expertise. In addition, they are still limited by our ability to predict sediment transport processes and wave climates.

(3) Calibration and verification.

(a) Model calibration is the use of a model to reproduce changes in shoreline position measured over a certain time interval. Verification is application of a model to reproduce beach changes over a time interval different than the one used for the model's calibration. Successful verification means that the model's predictions are independent of the calibration interval. However, if empirical coefficients or boundary conditions change (for example, by the construction of an entrance channel which interrupts sand transport) the verification is no longer valid. Therefore, a modeler must be aware of any changes in physical conditions at the study site that could affect the validity of his model.

(b) Unfortunately, in practice, data sets are usually insufficient to perform rigorous calibration and verification of a model. Typically, wave gauge data are missing, and historical shoreline change maps are usually spotty or unsuitable. In situations where data are lacking, coastal experience must be relied upon to provide reasonable input parameters. This underscores that considerable subjectivity is part of the modeling procedure, even if the model itself is mathematically rigorous.

(4) Sensitivity testing.

(a) This refers to the process of examining changes in the output of a model resulting from intentional changes

in the input. If large changes are caused by minor changes in the input, the overall results will depend greatly upon the quality of the verification. Unfortunately, for many practical applications, there is some degree of doubt in the verification (Hanson and Kraus 1989) (Figure 5-44). If a model is oversensitive to small changes in input values, the range of predictions will be too broad and will in essence provide no information.

(b) In summary, numerical models are a valuable complement to prototype data collection and physical (scale) models of coastal processes. However, useful numerical models require empirical input during the calibration and may be based on incomplete data sets.

Therefore, the reader is urged to be cautious of the output of any model and to be aware of the results of the verification and sensitivity tests.

5-6. Summary

a. Before initiating detailed field, laboratory, or office study, a thorough literature review and investigation of secondary data sources must be conducted. Existing sources of data are numerous, including information on processes such as waves, water levels, and currents, information on geomorphology such as geologic, topographic, and shoreline change maps, as well as information that has been previously interpreted in the literature or has yet to be interpreted such as aerial photography. If such a search is not conducted, assessment of geologic history is likely to be less reliable, field studies may be poorly planned, and considerable expense may be wasted because of duplication of existing information.

b. A wide variety of techniques and technologies are available for data collection, analysis, and interpretation of the geologic and geomorphic history of coasts. One means of acquiring coastal data is through field data collection and observation. These data may be numerical or non-numerical, and may be analyzed further in the laboratory and office depending upon the type of data collected. Laboratory studies are used to analyze geological properties of data collected in the field, such as grain size or mineralogy, or to collect data through physical model experiments, such as in wave tanks. Office studies are part of most investigations, in that they involve the analysis and/or the interpretation of data collected in the field and laboratory, from primary and secondary sources. Typically, the best overall understanding of environmental processes and the geologic history of coasts is acquired through a combination of techniques and lines of inquiry.

A suggested flowchart for conducting studies of coastal geology is illustrated in Figure 5-45.

c. Many recent developments and techniques are used in the analysis of coastal data sets. The evaluation of geologic and geomorphic history is largely dependent upon the availability and quality of research equipment, techniques, and facilities. New techniques are constantly being introduced, and it is important that the coastal geologist and engineer stay abreast of new techniques and methods, such as remote sensing and geophysical methods, computer software and hardware developments, and new laboratory methods.

d. In addition to keeping up with recent developments, the coastal scientist or engineer has the serious

responsibility of making accurate interpretations of the geologic and geomorphic history of coasts. It is vital that the important research problem and objectives be clearly defined, that important variables be incorporated in the study, and that the inherent limits and errors of the research techniques and technologies be recognized, including problems and assumptions involved in data collection and analysis. To some extent, the coastal scientist or engineer can make some adjustments for various sources of error. However, because of the geologic and geomorphic variability of coasts, extreme caution should be taken in extrapolating the final interpretations and conclusions regarding geologic history, particularly from data covering a short time period or a small area. For these reasons, assessment of the geologic and geomorphic history of coasts is an exceptionally challenging endeavor.

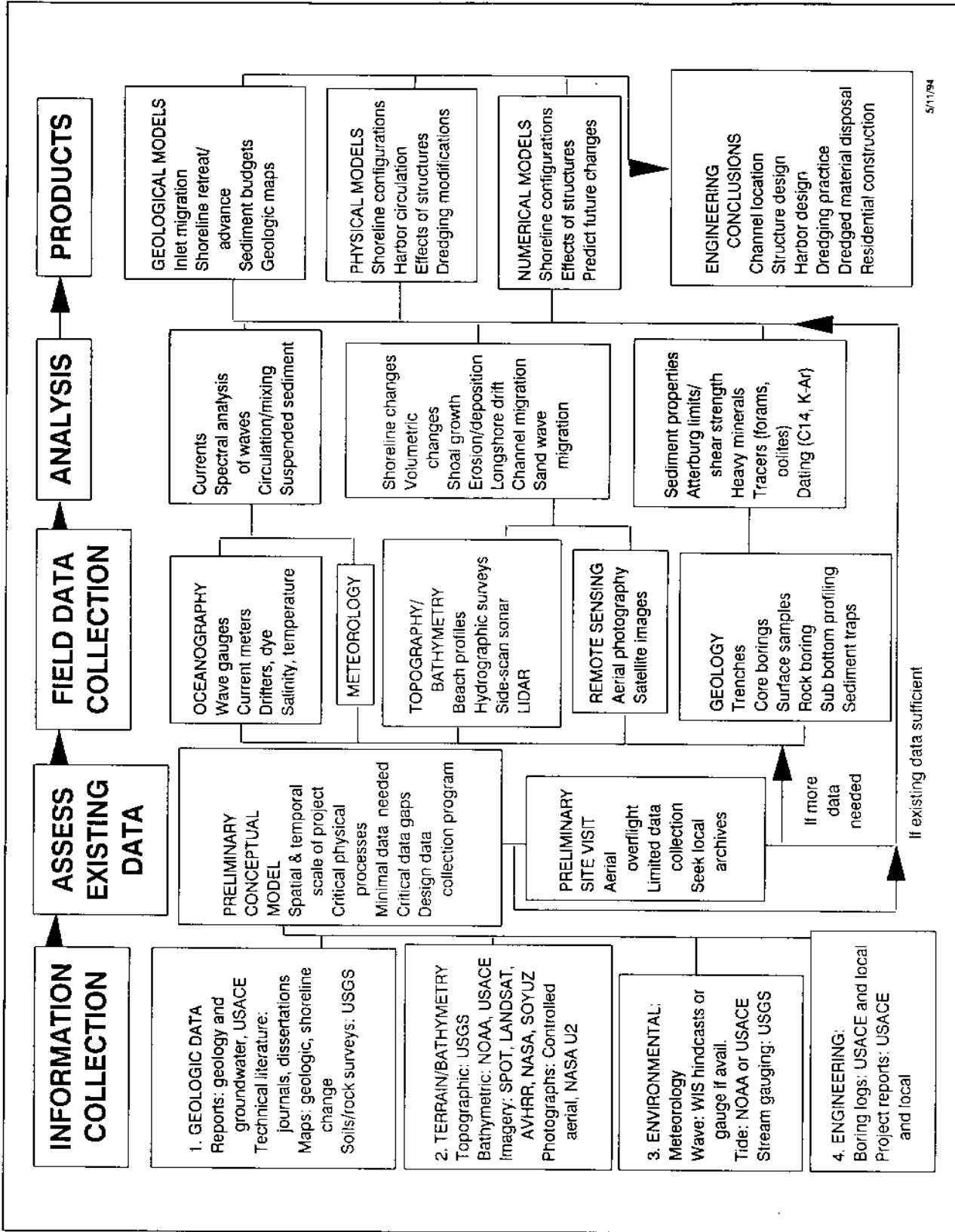

Figure 5-45. Flowchart for studies of coastal geology

Appendix A References

ER 1105-2-100

Guidance for Conducting Civil Works Planning Studies

EM 1110-1-1003

NAVSTAR Global Positioning System Surveying

EM 1110-1-1906

Soil Sampling

EM 1110-2-1003

Hydrographic Surveying

EM 1110-2-1412

Storm Surge Analysis and Design Water Level Determinations

EM 1110-2-1414

Water Levels and Wave Heights for Coastal Engineering Design

EM 1110-2-1502

Coastal Littoral Transport

EM 1110-2-1616

Sand Bypassing System Selection

EM 1110-2-1906

Laboratory Soils Testing

EM 1110-2-2302

Construction with Large Stone

EM 1110-2-2904

Design of Breakwaters and Jetties

Allen 1968

Allen, J. R. L. 1968. *Current Ripples: Their Relation to Patterns of Water and Sediment Movement*, North Holland, Amsterdam, Netherlands.

Allen 1976

Allen, E. S. 1976. *A Wind to Shake the World*, Little Brown & Co., New York, NY.

Allen 1984

Allen, J. R. L. 1984. "Sedimentary Structures, Their Character and Physical Basis," *Developments in Sedimentology*, Vol 30, Elsevier, New York, NY.

Allen 1985

Allen, J. R. L. 1985. *Principles of Physical Sedimentology*, George Allen and Unwin, London, UK.

American Society for Testing and Materials 1964

American Society for Testing and Materials. 1964. *Procedures for Testing Soils*, 4th ed., ASTM Committee D-18, Philadelphia, PA.

American Society for Testing and Materials 1993

American Society for Testing and Materials. 1993. *1993 Annual Book of ASTM Standards*, Section 4, Construction, Vol 4.08, Soil and Rock; Dimension Stone; Geosynthetics, American Society for Testing and Materials, Philadelphia, PA.

Anders and Byrnes 1991

Anders, F. J., and Byrnes, M. R. 1991. "Accuracy of Shoreline Change Rates as Determined from Maps and Aerial Photographs," *Shore and Beach*, Vol 59, No. 1, pp 17-26.

Anders, Reed, and Meisburger 1990

Anders, F. J., Reed, D. W., and Meisburger, E. P. 1990. "Shoreline Movements; Report 2: Tybee Island, Georgia to Cape Fear, North Carolina: 1851-1983," Technical Report CERC-83-1, U.S. Army Engineer Waterways Experiment Station, Vicksburg, MS.

Anderson, Lyons, and Cowie 1994

Anderson, R. F., Lyons, T. W., and Cowie, G. L. 1994. "Sedimentary Record of a Shoaling of the Oxidic/Anoxic Interface in the Black Sea," *Marine Geology*, Vol 116, No. 3/4, pp 373-384.

Appell and Curtin 1990

Appell, G. F., and Curtin, T. B., eds. 1990. *Proceedings of the IEEE Fourth Working Conference on Current Measurement*, Current Measurement Technology Committee of the Oceanic Engineering Society, Institute of Electrical and Electronics Engineers, New York, NY.

Arlman, Santema, and Svašek 1958

Arlman, J. J., Santema, P., and Svašek, J. N. 1958. "Movement of Bottom Sediment in Coastal Waters by Currents and Waves; Measurements with the Aid of Radioactive Tracers in the Netherlands," Technical Memorandum No. 105, Beach Erosion Board, U.S. Army Engineer Waterways Experiment Station, Vicksburg, MS.

Ashley 1990

Ashley, G. M. 1990. "Classification of Large-Scale Subaqueous Bedforms: A New Look at an Old Problem," *Journal of Sedimentary Petrology*, Vol 60, pp 363-396.

Aubrey and Speer 1984

Aubrey, D. G., and Speer, P. E. 1984. "Updrift Migration of Tidal Inlets," *Journal of Geology*, Vol 92, pp 531-546.

Aubrey and Weishar 1988

Aubrey, D. G., and Weishar, L., eds. 1988. *Hydrodynamics and Sediment Dynamics of Tidal Inlets*, Lecture Notes on Coastal and Estuarine Studies, Vol 29, Springer-Verlag, New York, NY.

Bagnold 1941

Bagnold, R. A. 1941. *The Physics of Windblown Sand and Desert Dunes*, Methuen, London, UK.

Bagnold 1954

Bagnold, R. A. 1954. *The Physics of Blown Sand and Desert Dunes*, 2nd ed., Methuen, London, UK.

Bagnold 1963

Bagnold, R. A. 1963. "Mechanics of Marine Sedimentation," In: *The Sea*, M. N. Hill, ed., Interscience, New York, NY, pp 507-528.

Bahr and Lanier 1981

Bahr, L. M., and Lanier, W. P. 1981. "The Ecology of Intertidal Oyster Reefs of the South Atlantic Coast: A Community Profile," Report FWS/OBS-81/15, U.S. Fish and Wildlife Service, Office of Biological Services, Washington, DC.

Ballard 1983

Ballard, R. D. 1983. *Exploring our Living Planet*, National Geographic Society, Washington, DC.

Barnett 1984

Barnett, T. P. 1984. "The Estimation of 'Global' Sea Level: A Problem of Uniqueness," *Journal of Geophysical Research*, Vol 89, No C5, pp 7980-7988.

Barrick, Evans, and Weber 1977

Barrick, D. E., Evans, M. W., and Weber, B. L. 1977. "Ocean Surface Currents Mapped by Radar," *Science*, Vol 198, pp 138-144.

Barrick, Lipa, and Lilleboe 1990

Barrick, D. E., Lipa, B. J., and Lilleboe, P. M. 1990.

"HF Radar Surface-Current Mapping: Recent U.S./Canadian Advances," *Proceedings of the IEEE Fourth Working Conference on Current Measurement*, G. F. Appell and T. B. Curtin, eds., Current Measurement Technology Committee of the Oceanic Engineering Society, Institute of Electrical and Electronics Engineers, New York, NY, pp 22-29.

Barwis 1976

Barwis, J. H. 1976. "Annotated Bibliography on the Geologic, Hydraulic, and Engineering Aspects of Tidal Inlets," General Investigation of Tidal Inlets Report 4, U.S. Army Engineer Waterways Experiment Station, Vicksburg, MS.

Basan and Frey 1977

Basan, P. B., and Frey, R. W. 1977. "Actual-Paleontology and Neoichnology of Salt Marshes Near Sapelo Island, Georgia," *Trace Fossils 2*, *Geology Journal*, Special Issue 9, T. P. Crimes and J. C. Harper, eds., Seel House Press, Liverpool, UK, pp 41-70.

Bascom 1964

Bascom, W. 1964. *Waves and Beaches, the Dynamics of the Ocean Surface*, Doubleday & Co., Garden City, NY.

Bass, Fulford, Underwood, and Parson, in preparation

Bass, G. P., Fulford, E. T., Underwood, S. G., and Parson, L. E. "Rehabilitation of the South Jetty, Ocean City, Maryland," Technical Report CERC-94-6, U.S. Army Engineer Waterways Experiment Station, Vicksburg, MS.

Bates 1953

Bates, C. C. 1953. "National Theory of Delta Formation," *Bulletin of the American Association of Petroleum Geologists*, Vol 37, pp 2119-2161.

Bates and Jackson 1984

Bates, R. L., and Jackson, J. A. 1984. *Dictionary of Geologic Terms*, 3rd ed., Anchor Press/Doubleday, Garden City, NY.

Battan 1984

Battan, L. J. 1984. *Fundamentals of Meteorology*, Prentice Hall, Englewood Cliffs, NJ.

Bendat and Piersol 1986

Bendat, J. S., and Piersol, A. G. 1986. *Random Data-Analysis and Measurement Procedures*, 2nd ed., John Wiley & Sons, New York, NY.

Bird 1976

Bird, E. C. F. 1976. "Shoreline Changes During the Past Century," *Proceedings of the 23rd International Geographic Congress, Moscow*, Pergamon, Elmsford, NY.

Birkemeier 1984

Birkemeier, W. A. 1984. "The Interactive Survey Reduction Program: User's Manual of ISRP," Instruction Report CERC-84-1, U.S. Army Engineer Waterways Experiment Station, Vicksburg, MS.

Birkemeier 1985

Birkemeier, W. A. 1985. "Field Data on Seaward Limit of Profile Change," *Journal of Waterway, Port, Coastal and Ocean Engineering*, Vol 111, No. 3, pp 598-602.

Birkemeier, Kraus, Scheffner, and Knowles 1987

Birkemeier, W. A., Kraus, N. C., Scheffner, N. W., and Knowles, S. C. 1987. "Feasibility Study of Quantitative Erosion Models for Use by the Federal Emergency Management Agency," Technical Report CERC-87-8, U.S. Army Engineer Waterways Experiment Station, Vicksburg, MS.

Birkemeier, Miller, Wilhelm, DeWall, and Gorbics 1985

Birkemeier, W. A., Miller, H. C., Wilhelm, S. D., DeWall, A. E., and Gorbics, C. S. 1985. "A User's Guide to the Coastal Engineering Research Center's (CERC's) Field Research Center," Instruction Report CERC-85-1, U.S. Army Engineer Waterways Experiment Station, Vicksburg, MS.

Boggs 1987

Boggs, S., Jr. 1987. *Principles of Sedimentology and Stratigraphy*, Merrill Publishing Company, Columbus, OH.

Boothroyd 1985

Boothroyd, J. C. 1985. "Tidal Inlets and Tidal Deltas," *Coastal Sedimentary Environments*, 2nd ed., R. A. Davis, ed., Springer-Verlag, New York, NY, pp 445-532.

Bos 1990

Bos, W. G. 1990. "A Comparison of Two Doppler Current Profilers," *Proceedings of the IEEE Fourth Working Conference on Current Measurement*, G. F. Appell and T. B. Curtin, eds., Current Measurement Technology Committee of the Oceanic Engineering Society, Institute of Electrical and Electronics Engineers, New York, NY, pp 207-214.

Bouma 1969

Bouma, Arnold H. 1969. *Methods for the Study of Sedimentary Structures*, John Wiley, New York.

Bowen 1969

Bowen, A. J. 1969. "Rip Currents; 1: Theoretical Investigations," *Journal of Geophysical Research*, Vol 74, pp 5467-5478.

Bowen 1980

Bowen, A. J. 1980. "Simple Models of Nearshore Sedimentation, Beach Profiles and Longshore Bars," *The Coast of Canada*, S. B. McCann, ed., Geological Survey of Canada, Ottawa, pp 1-11.

Bowen and Inman 1966

Bowen, A. J., and Inman, D. L. 1966. "Budget of Littoral Sands in the Vicinity of Point Arguello, California," Technical Memorandum, Coastal Engineering Research Center, U.S. Army Engineer Waterways Experiment Station, Vicksburg, MS.

Bowen and Inman 1969

Bowen, A. J., and Inman, D. L. 1969. "Rip Currents; 2: Laboratory and Field Observations," *Journal of Geophysical Research*, Vol 74, pp 5479-5490.

Bowes 1989

Bowes, M. A. 1989. "Review of the Geomorphic Diversity of the Great Lakes Shore Zone in Canada," Heritage Resources Centre, University of Waterloo, Waterloo, Canada.

Bowles 1979

Bowles, J. E. 1979. *Physical and Geotechnical Properties of Soils*, McGraw-Hill, New York, NY.

Bowles 1986

Bowles, J. E. 1986. *Engineering Property of Soils and Their Measurement*, 3rd ed., McGraw-Hill, New York, NY.

Boyd, Dalrymple, and Zaitlin 1992

Boyd, R., Dalrymple, R., and Zaitlin, B. A. 1992. "Classification of Elastic Coastal Depositional Environments," *Sedimentary Geology*, Vol 80, pp 139-150.

Brenninkmeyer 1978

Brenninkmeyer, B. M. 1978. "Heavy Minerals," *The Encyclopedia of Sedimentology*, R. W. Fairbridge and

J. Bougeois, eds., Dowden, Hutchinson and Ross, Inc., Stroudsburg, PA, pp 400-402.

Bretherton, Davis, and Fandry 1976

Bretherton, F. P., Davis, R. E., and Fandry, C. B. 1976. "A Technique for Objective Analysis and Design of Oceanographic Experiments Applied to MODE-73," *Deep-Sea Research*, Vol 23, pp 559-582.

Brinker and Wolf 1984

Brinker, R. C., and Wolf, P. R. 1984. *Elementary Surveying*, 7th ed., Harper and Row Publishers, New York, NY.

British Standards Institution 1975

British Standards Institution. 1975. *Methods of Testing Soils for Civil Engineering Purposes, BSI377, London, U.K.*

Bruun 1954

Bruun, P. 1954. "Coast Erosion and the Development of Beach Profiles," Technical Memorandum No. 44, Beach Erosion Board, U.S. Army Engineer Waterways Experiment Station, Vicksburg, MS.

Bruun 1962

Bruun, P. M. 1962. "Sea-level Rise as a Cause of Shore Erosion," *Proceedings, Journal of the Waterways and Harbor Division*, American Society of Civil Engineers, Vol 88, No. WW1, pp 117-130.

Bruun 1963

Bruun, P., 1963. "Sea-level Rise as a Cause of Shore Erosion," *Journal of the Waterways, Harbors and Coastal Engineering Division*, ASCE, Vol 88, No. WW1, pp 117-130.

Bruun 1966

Bruun, P. 1966. *Tidal Inlets and Littoral Drift*, Universitets-forlaget, Norway (in English).

Bruun 1988

Bruun, P. 1988. "The Bruun Rule of Erosion by Sea-Level Rise: A Discussion of Large-Scale Two- and Three-Dimensional Usages," *Journal of Coastal Research*, Vol 4, pp 627-648.

Bruun and Gerritsen 1959

Bruun, P., and Gerritsen, F. 1959. "Natural By-passing of Sand at Coastal Inlets," *Journal of Waterways and Harbors Division*, American Society of Civil Engineers, New York, NY, pp 75-107.

Bruun and Gerritsen 1961

Bruun, P., and Gerritsen, F. 1961. "Stability of Coastal Inlets," *Proceedings of the Seventh Conference on Coastal Engineering*, August 1960, The Hague, Netherlands, J. W. Johnson, ed., Council on Wave Research, University of California, Berkeley, CA, pp 386-417.

Bullard 1962

Bullard, F. M. 1962. *Volcanoes in History, in Theory, in Eruption*, University of Texas Press, Austin, TX.

Buller and McManus 1979

Buller, A. T., and McManus, J. 1979. "Sediment Sampling and Analysis," *Estuarine Hydrography and Sedimentation*, K. R. Dyer, ed., Cambridge University Press, Cambridge, UK.

Byrnes and Hiland 1994

Byrnes, M. A., and Hiland, M. W. 1994. "Shoreline Position and Nearshore Bathymetric Change," *Kings Bay Coastal and Estuarine Physical Monitoring and Evaluation Program: Coastal Studies; Volume I, Main Text and Appendix A*, N. C. Kraus, L. T. Gorman, and J. Pope, eds., Technical Report CERC-94-9, U.S. Army Engineer Waterways Experiment Station, Vicksburg, MS, pp 61-144.

Carter 1988

Carter, R. W. G. 1988. *Coastal Environments: An Introduction to the Physical, Ecological, and Cultural Systems of Coastlines*, Academic Press, London, UK.

Carter, Curtis, and Sheehy-Skeffington 1992

Carter, R. W. G., Curtis, T. G. F., and Sheehy-Skeffington, M. J., 1992. *Coastal Dunes, Geomorphology, Ecology, and Management for Conservation*, Al A. Balkema, Rotterdam, The Netherlands.

Carter, Williams, Fuller, and Meisburger 1982

Carter, C. H., Williams, S. J., Fuller, J. A., and Meisburger, E. P. 1982. "Regional Geology of the Southern Lake Erie (Ohio) Bottom: A Seismic Reflection and Vibracore Study," Miscellaneous Report No 82-15, Coastal Engineering Research Center, U.S. Army Engineer Waterways Experiment Station, Vicksburg, MS.

Castañer 1971

Castañer, P. F. 1971. "Selected Bibliography on the Engineering Characteristics of Coastal Inlets," Report HEL 24-7, Hydraulic Engineering Laboratory, University of California, Berkeley, CA.

Chapman 1974

Chapman, V. J. 1974. "Salt Marshes and Salt Deserts of the World," *Ecology of Halophytes*, R. J. Reimold and W. H. Queen, eds., Academic Press, NY, pp 3-19.

Chasten 1992

Chasten, M. A. 1992. "Coastal Response to a Dual Jetty System at Little River Inlet, North and South Carolina," Miscellaneous Paper CERC-92-2, U.S. Army Engineer Waterways Experiment Station, Vicksburg, MS

Chasten and Seabergh 1992

Chasten, M. A., and Seabergh, W. C. 1992. "Engineering Assessment of Hydrodynamics and Jetty Scour at Little River Inlet, North and South Carolina," Miscellaneous Paper CERC-92-10, U.S. Army Engineer Waterways Experiment Station, Vicksburg, MS.

Chave, Luther, and Filloux 1990

Chave, A. D., Luther, D. S., and Filloux, J. H. 1990. "Spatially-Averaged Velocity from the Seafloor Horizontal Electrical Field," *Proceedings of the IEEE Fourth Working Conference on Current Measurement*, G. F. Appell and T. B. Curtin, eds., Current Measurement Technology Committee of the Oceanic Engineering Society, Institute of Electrical and Electronics Engineers, New York, NY, pp 46-53.

Chiu 1977

Chiu, T.Y. 1977. "Beach and Dune Response to Hurricane Eloise of September 1975," *Proceedings Coastal Sediments '77*, American Society of Civil Engineers, New York, NY, pp 116-134.

Clausner, Birkemeier, and Clark 1986

Clausner, J. E., Birkemeier, W. A., and Clark, G. R. 1986. "Field Comparison of Four Nearshore Survey Systems," Miscellaneous Paper CERC-86-6, U.S. Army Engineer Waterways Experiment Station, Vicksburg, MS.

Clifton and Dingler 1984

Clifton, H. E., and Dingler, J. R. 1984. "Wave-formed Structures and Paleoenvironmental Reconstruction," *Marine Geology*, Vol 60, pp 165-198.

Coastal Engineering Research Center 1991

Coastal Engineering Research Center. 1991. "Recommended Physical Data Collection Program for Beach Renourishment Projects," Coastal Engineering Technical Note CETN II-26, U.S. Army Engineer Waterways Experiment Station, Vicksburg, MS.

Cole 1980

Cole, F. W. 1980. *Introduction to Meteorology*, John Wiley and Sons, Inc., New York, NY.

Coleman 1988

Coleman, J. M. 1988. "Dynamic Changes and Processes in the Mississippi River Delta," *Bulletin of the Geological Society of America*, Vol 100, pp 999-1015.

Coleman and Garrison 1977

Coleman, J. M., and Garrison, L. E. 1977. "Geological Aspects of Marine Slope Instability, Northwestern Gulf of Mexico," *Marine Geotechnology*, Vol 2, pp 9-44.

Coleman and Wright 1971

Coleman, J. M., and Wright, L. D. 1971. "Analysis of Major River Systems and Their Deltas: Procedures and Rationale, with Two Examples," Technical Report No. 95, Coastal Studies Institute, Louisiana State University, Baton Rouge, LA.

Coleman and Wright 1975

Coleman, J. M., and Wright, L. D. 1975. "Modern River Deltas: Variability of Process and Sand Bodies," *Deltas, Models for Exploration*, M. L. Broussard, ed., Houston Geological Society, Houston, TX, pp 99-149.

Colwell 1983

Colwell, R. N., Editor-in-chief. 1983. *Manual of Remote Sensing*, 2nd ed., (in 2 volumes), American Society of Photogrammetry, Falls Church, VA.

Construction Industry Research and Information Association (CIRIA) 1991

Construction Industry Research and Information Association (CIRIA). 1991. Manual on the Use of Rock in Coastal and Shoreline Engineering, CIRIA Special Publication 83, London, UK (also published as: Centre for Civil Engineering Research and Codes (CUR) Report 154, Gouda, The Netherlands).

Cook and Gorsline 1972

Cook, D. O., and Gorsline, D. S. 1972. "Field Observations of Sand Transport by Shoaling Waves," *Marine Geology*, Vol 13, pp 31-55.

Coordinating Committee on Great Lakes Basic Hydraulic and Hydrologic Data 1992

Coordinating Committee on Great Lakes Basic Hydraulic and Hydrologic Data. 1992. "IGLD 1985," Brochure

describing the International Great Lakes Datum 1985, U.S. Government Printing Office, Washington, DC.

Cotton 1952

Cotton, C. A. 1952. "Criteria for the Classification of Coasts," Abstract of papers, 17th Congress of International Geographers, Washington, DC, p 15.

Cromwell 1971

Cromwell. 1971. Barrier Coast Distribution: A Worldwide Survey," Abstracts, Second Coastal and Shallow Water Research Conference, U.S. Office of Naval Research Geography Program, University Press, University of Southern California, Los Angeles, CA, p 50.

Cronin 1975

Cronin, L. E., ed. 1975. *Estuarine Research*, Academic Press, New York, NY (2 volumes).

Crowell, Leatherman, and Buckley 1991

Crowell, M., Leatherman, S. P., and Buckley, M. K. 1991. "Historical Shoreline Change: Error Analysis and Mapping Accuracy," *Journal of Coastal Research*, Vol 7, No. 3, pp 839-852.

Curray 1964

Curray, J. R. 1964. "Transgressions and Regressions," *Papers in Marine Geology: Shepard Commemorative Volume*, R. L. Mills, ed., MacMillan, New York, NY.

Curray 1965

Curray, J. R. 1965. "Late Quaternary History, Continental Shelves of the United States," *The Quaternary of the United States*, H. E. Wright, Jr. and D. G. Frey, eds., Princeton University Press, Princeton, NJ, pp 713-735.

Dally, Dean, and Dalrymple 1985

Dally, W. R., Dean, R. G., and Dalrymple, R. A. 1985. "Wave Height Variation Across Beaches of Arbitrary Profile," *Journal of Geophysical Research*, Vol 90, No. C6, pp 11917-11927.

Dalrymple 1992

Dalrymple, R. A. 1992. "Prediction of Storm/Normal Beach Profiles," *Journal of Waterway, Port, Coastal and Ocean Engineering*, Vol 118, No. 2, pp 193-200.

Dalrymple, Silver, and Jackson 1973

Dalrymple, G. B., Silver, E. I., and Jackson, E. D. 1973. "Origin of the Hawaiian Islands," *American Scientist*, Vol 61, No. 3, pp 294-308.

Dalrymple, Zaitlin, and Boyd 1992

Dalrymple, R. W., Zaitlin, B. A., and Boyd, R. 1992. "Estuarine Facies Models: Conceptual Basis and Stratigraphic Implications," *Journal of Sedimentary Petrology*, Vol 62, No. 6, pp 1130-1146.

Dana 1849

Dana, J. D. 1849. "Geology," *Report of the U.S. Exploring Expedition, 1838-1842*, C. Sherman, Philadelphia, PA.

Davidson, Dean, and Edge 1990

Davidson, M. A., Dean, R. G., and Edge, B. L. 1990. *Shore and Beach*, Vol 58, No. 4 (Special issue dedicated to Hurricane Hugo papers).

Davidson-Arnott and Greenwood 1976

Davidson-Arnott, R. G. D., and Greenwood, B. 1976. "Facies Relationships on a Barred Coast, Kouchibouguac Bay, New Brunswick, Canada," *Beach and Nearshore Sedimentation*, R. A. Davis, Jr. and R. L. Ethington, eds., Society of Economic Paleontologists and Mineralogists Special Publication 24, Tulsa, OK, pp 149-168.

Davies 1964

Davies, J. L. 1964. "A Morphogenic Approach to World Shorelines," *Zeitschrift für Geomorphology*, Vol 8, pp 27-42.

Davies 1973

Davies, J. L. 1973. *Geographical Variation in Coastal Development*, Hafner Publishing Company, New York, NY.

Davies 1980

Davies, J. L. 1980. *Geographical Variation in Coastal Development*, 2nd ed., Longman Group, London, UK.

Davis 1896a

Davis, W. M. 1896a. "Shoreline Topography," reprinted in: *Geographical Essays*, Dover Publications, New York, NY (1954 reprint).

Davis 1896b

Davis, W. M. 1896b. "The Outline of Cape Cod," *Proceedings, American Academy of Arts and Science*, Vol 31, pp 303-332.

Davis 1973

Davis, R. A. 1973. "Coastal Ice Formation and its Effect on Beach Sedimentation," *Shore and Beach*, Vol 41, pp 3-9.

Davis 1985

Davis, R. A., Jr., ed. 1985. *Coastal Sedimentary Environments*, 2nd ed., Springer-Verlag, New York, NY.

Davis and Ethington 1976

Davis, R. A., Jr., and Ethington, R. L. 1976. *Beach and Nearshore Sedimentation*, Society of Economic Paleontologists and Mineralogists (SEPM) Special Publication No. 24, Tulsa, OK.

Davis and Hayes 1984

Davis, R. A., Jr., and Hayes, M. O. 1984. "What is a Wave-Dominated Coast?, Hydrodynamics and Sedimentation in Wave-Dominated Coastal Environments," B. Greenwood and R. A. Davis, Jr., eds., *Marine Geology*, Vol 60, pp 313-329.

Davis and Schultz 1990

Davis, B. E., and Schultz, K. L. 1990. "Geographic Information Systems, a Primer," Contract Report ITL-90-1, U.S. Army Engineer Waterways Experiment Station, Vicksburg, MS.

Davis and Weller 1980

Davis, R. E., and Weller, R. A. 1980. "Propeller Current Sensors," *Air-Sea Interaction-Instruments and Methods*, F. Dobson, L. Hasse, and R. Davis, eds., Plenum Press, New York, NY, pp 141-153.

Dean 1973

Dean, R. G. 1973. "Heuristic Model of Sand Transport in the Surf Zone," *Proceedings of Engineering Dynamics in the Surf Zone*, Institute of Engineers, Australia, pp 208-214.

Dean 1976

Dean, R. G. 1976. "Beach Erosion: Causes, Processes, and Remedial Measures," *CRC Reviews in Environmental Control*, CRC Press Inc., Boca Raton, FL, Vol 6, Issue 3, pp 259-296.

Dean 1977

Dean, R. G. 1977. "Equilibrium Beach Profiles - U.S. Atlantic and Gulf Coasts," Ocean Engineering Report No. 12, University of Delaware, Newark, DE, pp 1-45.

Dean 1984

Dean, R. G. 1984. "Applications of Equilibrium Beach Profile Concepts," *Coastal Engineering Abstracts*, American Society of Civil Engineers, New York, NY, pp 140-141.

Dean 1987

Dean, R. G. 1987. "Coastal Sediment Processes: Toward Engineering Solutions," *Proceedings of Coastal Sediments '87*, American Society of Civil Engineers, New York, NY, pp 1-24.

Dean 1988

Dean, R. G. 1988. "Sediment Interaction at Modified Coastal Inlets: Processes and Policies," *Hydrodynamics and Sediment Dynamics of Tidal Inlets*, Lecture Notes on Coastal and Estuarine Studies, D. G. Aubrey and L. Weishar, eds., Vol 29, Springer-Verlag, New York, NY, pp 412-439.

Dean 1990

Dean, R. G. 1990. "Equilibrium Beach Profiles: Characteristics and Applications," Report UFL/COEL-90/001, Coastal & Oceanographic Engineering Department, University of Florida, Gainesville, FL.

Dean 1991

Dean, R. G. 1991. "Equilibrium Beach Profiles: Characteristics and Applications," *Journal of Coastal Research*, Vol 7, No. 1, pp 53-84.

Dean and Maurmeyer 1983

Dean, R. G., and Maurmeyer, E. M. 1983. "Models for Beach Profile Response," *CRC Handbook of Coastal Process and Erosion*, P. D. Komar, ed., CRC Press, Boca Raton, FL, pp 151-166.

de Beaumont 1843

de Beaumont, L. E. 1845. Septième leçon, in: *Leçons de Géologie Pratique*, P. Bertrand, Paris, France, pp 221-252.

de Blij and Muller 1993

de Blij, H. J., and Muller, P. O. 1993. *Physical Geography of the Global Environment*, John Wiley & Sons, New York, NY.

Deery and Howard 1977

Deery, J. R., and Howard, J. D. 1977. "Origin and Character of Washover Fans on the Georgia Coast, USA,"

Gulf Coast Association Geologic Society Transactions, Vol 27, pp 259-271.

Dietrich, Dutro, and Foose 1982

Dietrich, R. V., Dutro, J. T., Jr., and Foose, R. M., Compilers. 1982. *AGI Data Sheets for Geology in the Field, Laboratory, and Office*, American Geological Institute, Alexandria, VA.

Dillon 1970

Dillon, W. P. 1970. "Submergence Effects on a Rhode Island Barrier and Lagoon and Inferences on Migration of Barriers," *Journal of Geology*, Vol 78, pp 94-106.

Dillon and Oldale 1978

Dillon, W. D., and Oldale, R. N. 1978. "Late Quaternary Sea Level Curve: Reinterpretation Based on Glacio-Eustatic Influence," *Geology*, Vol 6, pp 56-60.

Dingler, Reiss, and Plant 1993

Dingler, J. R., Reiss, T. E., and Plant, N. G. 1993. "Erosional Patterns of the Isles Dernieres, Louisiana, in Relation to Meteorological Influences," *Journal of Coastal Research*, Vol 9, No. 1, pp 112-125.

Dionne and Laverdiere 1972

Dionne, J. C., and Laverdiere, C. 1972. "Ice-Formed Beach Features From Lake St. Jean, Quebec," *Canadian Journal of Earth Science*, Vol 9, pp 979-990.

Dolan and Davis 1992

Dolan, R., and Davis, R. E. 1992. "Rating Northeasters," *Mariners Weather Log*, Vol 36, No 1, pp 4-11.

Dolan and Hayden 1983

Dolan, R., and Hayden, B. 1983. "Patterns and Prediction of Shoreline Change," *CRC Handbook of Coastal Processes*, P. D. Komar, ed., CRC Press, Boca Raton, FL, pp 123-165.

Dolan, Hayden, May, and May 1980

Dolan, R. B., Hayden, B., May, P., and May, S. 1980. "Reliability of Shoreline Change Measurements from Aerial Photographs," *Shore and Beach*, Vol 48, No. 4, pp 22-29.

Dolan, Hayden, and May 1983

Dolan, R., Hayden, B., and May, S. 1983. "Erosion of the U.S. Shorelines," *CRC Handbook of Coastal Processes and Erosion*, P. D. Komar, ed., CRC Press, Inc., Boca Raton, FL, pp 285-299.

Dorn 1983

Dorn, R. I. 1983. "Cation-Ratio Dating: A New Rock Varnish Age-Determination Technique," *Quaternary Research*, Vol 20, pp 49-73.

Douglass 1987

Douglass, S. L. 1987. "Coastal Response to Navigation Structures at Murrells Inlet, South Carolina," Technical Report CERC-87-2, U.S. Army Engineer Waterways Experiment Station, Vicksburg, MS.

Dronkers 1964

Dronkers, J. J. 1964. *Tidal Computations in Rivers and Coastal Waters*, North-Holland Publishing Company, Amsterdam, the Netherlands.

Duane 1970

Duane, D. B. 1970. "Tracing Sand Movement in the Littoral Zone: Progress in the Radioisotopic Sand Tracer (RIST) Study, July 1968-February 1969," Miscellaneous Paper No. 4-70, Coastal Engineering Research Center, U.S. Army Engineer Waterways Experiment Station, Vicksburg, MS.

Duane and Meisburger 1969

Duane, D. B., and Meisburger, E. P. 1969. "Geomorphology and Sediments of the Nearshore Continental Shelf, Miami to Palm Beach, Florida," Technical Memorandum No. 29, Coastal Engineering Research Center, USAE Waterways Experiment Station, Vicksburg, MS.

Duane, Field, Meisburger, Swift, and Williams 1972

Duane, D. B., Field, M. E., Meisburger, E. P., Swift, D. J. P., and Williams, S. J. 1972. "Linear Shoals on the Atlantic Inner Continental Shelf, Florida to Long Island," *Shelf Sediment Transport*, D. J. P. Swift, D. B. Duane, and O. H. Pilkey, eds., Dowd, Hutchinson, and Ross, Stroudsburg, PA.

Dugdale 1981

Dugdale, R. 1981. "Coastal Processes," *Geomorphological Techniques*, A. Goudie, ed., pp 247-265.

Dyer 1979

Dyer, K. R., ed. 1979. *Estuarine Hydrography and Sedimentation, a Handbook*, Cambridge University Press, Cambridge, UK.

Eckert and Callender 1987

Eckert, J., and Callender, G. 1987. "Geotechnical Engineering in the Coastal Zone," Instruction Report

CERC-87-1, U.S. Army Engineer Waterways Experiment Station, Vicksburg, MS.

Edwards and Frey 1977

Edwards, J. M., and Frey, R. W. 1977. "Substrate Characteristics Within a Holocene Salt Marsh, Sapelo Island, Georgia," *Senckenberg. Marit.*, Vol 9, pp 215-259.

Ellis 1978

Ellis, M. Y. 1978. *Coastal Mapping Handbook*, U.S. Geological Survey, U.S. Department of the Interior, and National Ocean Survey, U.S. Department of Commerce, U.S. Government Printing Office, Washington, DC.

Emery 1941

Emery, K. O. 1941. "Rate of Surface Retreat of Sea Cliffs Based on Dated Inscriptions," *Science*, Vol 93, pp 617-8.

Emery 1952

Emery, K. O. 1952. "Continental Shelf Sediments of Southern California," *Geological Society of America Bulletin*, Vol 63, pp 1105-1108.

Emery 1966

Emery, K. O. 1966. "Atlantic Continental Shelf and Slope of the United States-Geologic Background," Paper 529-A, U.S. Geological Survey, Washington, DC.

Emery 1967

Emery, K. O. 1967. "Estuaries and Lagoons in Relation to Continental Shelves," *Estuaries*, Publication 83, G. H. Lauff, ed., American Association for the Advancement of Science, Washington, DC, pp 9-11.

Emery 1968

Emery, K. O. 1968. "Relict Sediments on Continental Shelves of the World," *American Association of Petroleum Geologists Bulletin*, Vol 52, No. 3, pp 445-464.

Emery 1969

Emery, K. O. 1969. "The Continental Shelves," *Scientific American*, Vol 221, pp 107-122.

Emery and Aubrey 1991

Emery, K. O., and Aubrey, D. G. 1991. *Sea Levels, Land Levels, and Tide Gauges*, Springer-Verlag, New York, NY.

Environmental Systems Research Institute 1992

Environmental Systems Research Institute. 1992. "Understanding GIS - the ARC/INFO® Method," Rev. 6,

Environmental Systems Research Institute, Inc., Redlands, CA.

Escoffier 1940

Escoffier, F. F. 1940. "The Stability of Tidal Inlets," *Shore and Beach*, Vol 8, pp 114-115.

Escoffier 1977

Escoffier, F. F. 1977. "Hydraulics and Stability of Tidal Inlets," General Investigation of Tidal Inlets Report 13, U.S. Army Engineer Waterways Experiment Station, Vicksburg, MS.

Everts, Battley, and Gibson 1983

Everts, C. H., Battley, J. P., and Gibson, P. N. 1983. "Shoreline Movements, Report 1: Cape Henry, Virginia, to Cape Hatteras, North Carolina, 1849-1980," Technical Report CERC-83-1, U.S. Army Engineer Waterways Experiment Station, Vicksburg, MS.

Faegri and Iverson 1975

Faegri, K., and Iverson, J. 1975. *Textbook of Pollen Analysis*, Blackwell, Oxford, UK.

Faure 1977

Faure, G. 1977. *Principles of Isotope Geology*, John Wiley & Sons, New York, NY.

Field 1979

Field, M. E. 1979. "Sediments, Shallow Subbottom Structure, and Sand Resources of the Inner Continental Shelf, Central Delmarva Peninsula," Technical Paper No. 79-2, Coastal Engineering Research Center, U.S. Army Engineer Waterways Experiment Station, Vicksburg, MS.

Field and Duane 1974

Field, M. E., and Duane, D. B. 1974. "Geomorphology and Sediments of the Inner Continental Shelf, Cape Canaveral, Florida," Technical Memorandum No. 42, Coastal Engineering Research Center, USAE Waterways Experiment Station, Vicksburg, MS.

Finkl and Pilkey 1991

Finkl, C. W., and Pilkey, O. H. 1991. "Impacts of Hurricane Hugo: September 10-22, 1989," *Journal of Coastal Research*, Special Issue No. 8.

Fisher and Dolan 1977

Fisher, J. S., and Dolan, R. 1977. "Beach Processes and Coastal Hydrodynamics," *Benchmark Papers in Geology*, Vol 39, Dowden, Hutchinson & Ross, Stroudsburg, PA.

FitzGerald 1988

FitzGerald, D. M. 1988. "Shoreline Erosional-Depositional Processes Associated with Tidal Inlets," *Hydrodynamics and Sediment Dynamics of Tidal Inlets*, Lecture Notes on Coastal and Estuarine Studies, D. G. Aubrey and L. Weishar, eds., Vol 29, Springer-Verlag, New York, NY, pp 186-225.

FitzGerald and Nummedal 1983

FitzGerald, D. M., and Nummedal, D. 1983. "Response Characteristics of an Ebb-Dominated Tidal Inlet Channel," *Journal of Sedimentary Petrology*, Vol 53, No. 3, pp 833-845.

FitzGerald and Rosen 1987

FitzGerald, D. M., and Rosen, P. S., eds. 1987. *Glaciated Coasts*, Academic Press, San Diego, CA.

FitzGerald, Baldwin, Ibrahim, and Humphries 1992

FitzGerald, D. M., Baldwin, C. T., Ibrahim, N., and Humphries, S. M. 1992. "Sedimentologic and Morphologic Evolution of a Beach-Ridge Barrier along an Indented Coast: Buzzards Bay, Massachusetts," *Quaternary Coasts of the United States: Marine and Lacustrine Systems*, SEPM Special Publication No. 48, Tulsa, OK.

FitzGerald, Hubbard, and Nummedal 1978

FitzGerald, D. M., Hubbard, D. K., and Nummedal, D. 1978. "Shoreline Changes Associated with Tidal Inlets along the South Carolina Coast," *Proceedings Coastal Zone '78*, American Society of Civil Engineers, New York, NY, pp 1973-1994.

FitzGerald, Penland, and Nummedal 1984

FitzGerald, D. M., Penland, S., and Nummedal, D. 1984. "Control of Barrier Island Shape by Inlet Sediment Bypassing: Ease Friesian Islands, West Germany," *Marine Geology*, Vol 60, pp 355-376.

Flemming 1976

Flemming, B. W. 1976. "Side-scan Sonar: A Practical Guide," *International Hydrographic Review*, Vol 53, No. 1.

Flint 1971

Flint, R. F. 1971. *Glacial and Quaternary Geology*, John Wiley and Sons, New York, NY.

Folk 1974

Folk, R. L. 1974. *Petrology of Sedimentary Rock*, Hemphill Publishing Company, Austin, TX.

Folk 1980

Folk, R. L. 1980. *Petrology of Sedimentary Rocks*, Hemphill Publishing Company, Austin, TX.

Fox and Davis 1976

Fox, W. T., and Davis, R. A., Jr. 1976. "Weather Patterns and Coastal Processes," *Beach and Nearshore Sedimentation*, R. A. Davis, Jr., and R. L. Ethington, eds., Society of Economic Paleontologists and Mineralogists Special Publication No. 24, Tulsa, OK.

Fredette, Nelson, Miller-Way, Adair, Sotler, Clausner, Hands, and Anders 1990

Fredette, T. J., Nelson, D. A., Miller-Way, T., Adair, J. A., Sotler, V. A., Clausner, J. E., Hands, E. B., and Anders, F. J. 1990. "Selected Tools and Techniques for Physical and Biological Monitoring of Aquatic Dredged Material Disposal Sites," Technical Report D-90-11, Dredging Operations Technical Support Program, U.S. Army Engineer Waterways Experiment Station, Vicksburg, MS.

Frey and Basan 1985

Frey, R. W. and Basan, P. B. 1985. "Coastal Salt Marshes," *Coastal Sedimentary Environments*, R. A. Davis, Jr., ed., pp 225-301.

Friedlander, Kennedy, and Miller 1955

Friedlander, G., Kennedy, J. W., and Miller, J. M. 1955. *Nuclear and Radiochemistry*, John Wiley & Sons, New York, NY.

Friedman and Sanders 1978

Friedman, G. M., and Sanders, J. E. 1978. *Principles of Sedimentology*, John Wiley and Sons, New York, N.Y.

Frihy 1992

Frihy, O. E. 1992. "Sea-Level Rise and Shoreline Retreat of the Nile Delta Promontories, Egypt," *Natural Hazards*, Vol 5, pp 65-81.

Fuller and Meisberger 1982

Fuller, J. A., and Meisberger, E. P. 1982. "A Lightweight Pneumatic Coring Device: Design and Field Test," Miscellaneous Report No. 82-8, Coastal Engineering Research Center, U.S. Army Engineer Waterways Experiment Station, Vicksburg, MS.

Galvin 1968

Galvin, C. J. 1968. "Breaker Type Classification on Three Laboratory Beaches," *Journal of Geophysical Research*, Vol 73, pp 3651-3659.

Garland 1979

Garland, G. D. 1979. *Introduction to Geophysics*, W. B. Saunders Company, Philadelphia, PA.

Garrison and McMaster 1966

Garrison, L. E., and McMaster, R. L. 1966. "Sediments and Geomorphology of the Continental Shelf Off Southern New England," *Marine Geology*, Vol 4, pp 273-289.

Giese 1988

Giese, G. S. 1988. "Cyclical Behavior of the Tidal Inlet at Nauset Beach, Chatham, Massachusetts," *Hydrodynamics and Sediment Dynamics of Tidal Inlets*, Lecture Notes on Coastal and Estuarine Studies, Vol 29, D. G. Aubrey and L. Weishar, eds., Springer-Verlag, New York, NY, pp 269-283.

Gilbert 1885

Gilbert, G. K. 1885. 5th Annual Report, U.S. Geological Survey, Washington, DC, pp 87-88 (reprinted in Schwartz (1973)).

Glen 1979

Glen, N. C. 1979. "Tidal Measurement," *Estuarine Hydrography and Sedimentation*, K. R. Dyer, ed., Cambridge University Press, Cambridge, UK.

Godin 1972

Godin, G. 1972. *The Analysis of Tides*, University of Toronto Press, Toronto, Canada.

Goldsmith 1985

Goldsmith, V. 1985. "Coastal Dunes," *Coastal Sedimentary Environments*, 2nd ed., R. A. Davis, Jr., ed., Springer-Verlag, New York, NY, pp 303-378.

Gordon, Berezutskii, Kaneko, Stocchino, and Weisberg 1990

Gordon, R. L., Berezutskii, A. V., Kaneko, A., Stocchino, C., and Weisberg, R. H. 1990. "A Review of Interesting Results Obtained with Acoustic Doppler Current Profilers," *Proceedings of the IEEE Fourth Working Conference on Current Measurement*, G. F. Appell and T. B. Curtin, eds. Current Measurement Technology Committee of the Oceanic Engineering Society, Institute of Electrical and Electronics Engineers, New York, NY, pp 180-191.

Gorman 1991

Gorman, L. T. 1991. "Annotated Bibliography of Relative Sea Level Change," Technical Report CERC-91-16, U.S. Army Engineer Waterways Experiment Station, Vicksburg, MS.

Gorman and Reed 1989

Gorman, L. T., and Reed, D. W. (1989). "Shoreline Response of the Northern New Jersey Barrier System," *Proceedings Coastal Zone '89, Barrier islands: process and management*, American Society of Civil Engineers, New York, NY, pp 122-137.

Gorman, Pitchford, Stauble, and Langston, in preparation.

Gorman, L. T., Pitchford, K. R., Stauble, D. K., and Langston, J. T. "Appendix D, Survey and Sediment Grain-Size Data," *Kings Bay coastal and estuarine physical monitoring and evaluation program: Coastal studies; Volume II, Appendices B-G*, N. C. Kraus, L. T. Gorman, and J. Pope, eds., Technical Report CERC-94-9, U.S. Army Engineer Waterways Experiment Station, Vicksburg, MS, pp D1-D163.

Gornitz and Lebedeff 1987

Gornitz, V., and Lebedeff, S. 1987. "Global Sea-Level Changes During the Past Century," *Sea-Level Fluctuations and Coastal Evolution*, D. Nummedal, O. H. Pilkey, and J. D. Howard, eds., Special Publication No. 41, Society of Economic Paleontologists and Mineralogists, Tulsa, OK, pp 3-16.

Goudie 1981

Goudie, A., ed. 1981. *Geomorphological Techniques*, George Allen and Unwin, London, UK.

Gove 1986

Gove, P. B., ed. 1986. *Webster's Third International Dictionary*, Merriam-Webster, Springfield, MA.

Grabau 1913

Grabau, A. W. 1913. *Principles of Stratigraphy*, Dover, New York, NY.

Graf 1984

Graf, W. H. 1984. *Hydraulics of Sediment Transport*, Water Resources Publications, Littleton, CO.

Great Lakes Commission 1986

Great Lakes Commission. 1986. "Water Level Changes: Factors Influencing the Great Lakes," Great Lakes Commission, Ann Arbor, MI.

Greene 1970

Greene, H. G. 1970. "Microrelief of an Arctic Beach," *Journal of Sedimentary Petrology*, Vol 40, pp 419-427.

Greenwood and Davis 1984

Greenwood, B., and Davis, R. A., Jr. 1984. *Hydrodynamics and Sedimentation in Wave-Dominated Coastal Environments*, Developments in Sedimentology 39, Elsevier, Amsterdam, the Netherlands (reprinted from *Marine Geology*, Vol 60, Nos. 1-4).

Guilcher 1965

Guilcher, A. 1965. "Drumlin and Spit Structures in the Kenmare River, South-west Ireland," *Irish Geography*, Vol 5, No. 2, pp 7-19.

Gulliver 1899

Gulliver, F. P. 1899. "Shoreline Topography," *Proceedings of the American Academy of Arts and Science*, Vol 34, pp 149-258.

Guza and Inman 1975

Guza, R. T., and Inman, D. L. 1975. "Edge Waves and Beach Cusps," *Journal of Geophysical Research*, Vol 80, pp 2997-3012.

Hallermeier 1977

Hallermeier, R. J. 1977. "Calculating a Yearly Depth Limit to the Active Beach Profile," Technical Paper TP 77-9, Coastal Engineering Research Center, U.S. Army Engineer Waterways Experiment Station, Vicksburg, MS.

Hallermeier 1978

Hallermeier R. J. 1978. "Uses for a Calculated Limit Depth to Beach Erosion," *Proceedings of the 16th Coastal Engineering Conference*, American Society of Civil Engineers, New York, NY, pp 1493-1512.

Hallermeier 1979

Hallermeier, R. J. 1979. "Uses for a Calculated Limit Depth to Beach Erosion," *Proceedings of the Sixteenth Coastal Engineering Conference*, American Society of Civil Engineers, New York, NY, pp 1493-1512.

Hallermeier 1981a

Hallermeier, R. J. 1981a. "A Profile Zonation for Seasonal Sand Beaches from Wave Climate," *Coastal Engineering*, Vol 4, No. 3, pp 253-277.

Hallermeier 1981b

Hallermeier, R. J. 1981b. "Terminal Settling Velocity of Commonly Occurring Sand Grains," *Sedimentology*, Vol 28, No. 6, pp 859-865.

Hallermeier 1981c

Hallermeier, R. J. 1981c. "Seaward Limit of Significant Sand Transport by Waves: An Annual Zonation for Seasonal Profiles," Coastal Engineering Technical Aide CETA 81-2, Coastal Engineering Research Center, U.S. Army Engineer Waterways Experiment Station, Vicksburg, MS.

Hallermeier 1983

Hallermeier, R. J. 1983. "Sand Transport Limits in Coastal Structure Designs," *Proceedings of Coastal Structures '83*, American Society of Civil Engineers, pp 703-716.

Halpern 1978

Halpern, D. 1978. "Mooring Motion Influences on Current Measurements," *Proceedings of a Working Conference on Current Measurement*, Technical Report DEL-SG-3-78, College of Marine Studies, University of Delaware, Newark, DE, pp 69-76.

Halpern 1980

Halpern, D. 1980. "Moored Current Measurements in the Upper Ocean," *Air-Sea Interaction -- Instruments and Methods*, F. Dobson, L. Hasse, and R. Davis, eds., Plenum Press, New York, NY, pp 127-140.

Hands 1976

Hands, E. B. 1976. "Observations of Barred Coastal Profiles Under the Influence of Rising Water Levels, Eastern Lake Michigan, 1967-71," Technical Report 76-1, Coastal Engineering Research Center, U.S. Army Engineer Waterways Experiment Station, Vicksburg, MS.

Hands 1979

Hands, E. B. 1979. "Changes in Rates of Shore Retreat, Lake Michigan 1967-76," Technical Paper No. 79-4, U.S. Army Engineer Waterways Experiment Station, Coastal Engineering Research Center, Vicksburg, MS.

Hands 1980

Hands, E. B. 1980. "Prediction of Shore Retreat and Nearshore Profile Adjustments to Rising Water Levels on the Great Lakes," Technical Paper No. 80-7, U.S. Army Engineer Waterways Experiment Station, Coastal Engineering Research Center, Vicksburg, MS.

Hands 1983

Hands, E. B. 1983. "The Great Lakes as a Test Model for Profile Response to Sea Level Changes," Chapter 8 in *Handbook of Coastal Processes and Erosion*,

P. D. Komar, ed., CRC Press, Inc., Boca Raton, FL. (Reprinted in Miscellaneous Paper CERC-84-14, Coastal Engineering Research Center, U.S. Army Engineer Waterways Experiment Station, Vicksburg, MS.)

Hansen and Knowles 1988

Hansen, M., and Knowles, S. C. 1988. "Ebb-tidal Response to Jetty Construction at Three South Carolina Inlets," *Hydrodynamics and Sediment Dynamics of Tidal Inlets*, D. G. Aubrey and L. Weishar, eds., Lecture Notes on Coastal and Estuarine Studies, Vol 29, Springer-Verlag, New York, NY, pp 364-381.

Hanson and Kraus 1989

Hanson, H., and Kraus, N. C. 1989. "GENESIS: Generalized Model for Simulating Shoreline Change; Report 1, Technical Reference, Technical Report CERC-89-19, U.S. Army Engineer Waterways Experiment Station, Vicksburg, MS.

Harms 1969

Harms, J. C. 1969. "Hydraulic Significance of Some Sand Ripples," *Bulletin of the Geological Society of America*, Vol 80, pp 363-396.

Harris 1981

Harris, D. L. 1981. "Tides and Tidal Datums in the United States," Special Report No. 7, Coastal Engineering Research Center, U.S. Army Engineer Waterways Experiment Station, Vicksburg, MS.

Hathaway 1972

Hathaway, J. C. 1972. "Regional Clay Mineral Facies in Estuaries and Continental Margin of the United States and East Coast," *Environmental Framework of Coastal Plain Estuaries*, B. W. Nelson, ed., Geologic Society of America Memoir 133, Boulder, CO, pp 293-316.

Hayes 1979

Hayes, M. O. 1979. "Barrier Island Morphology as a Function of Tidal and Wave Regime," *Barrier Islands from the Gulf of St. Lawrence to the Gulf of Mexico*, S. P. Leatherman, ed., Academic Press, New York, NY, pp 1-29.

Hayes 1980

Hayes, M. O. 1980. "General Morphology and Sediment Patterns in Tidal Inlets," *Sedimentary Geology*, Vol 26, pp 139-156.

Hayes and Boothroyd 1969

Hayes, M. O., and Boothroyd, J. C. 1969. "Storms as Modifying Agents in the Coastal Environment," *Coastal Environments, Northeast Massachusetts and New Hampshire*, Eastern Section, Society of Economic Paleontologists and Mineralogists (SEPM), Field Guide. (Reprinted in: *Beach and Nearshore Sediments and Processes* 1987. SEPM Reprint Series Number 12, R. A. Davis, Jr., ed. SEPM, Tulsa, OK, pp 25-39.

Hayes and Kana 1976

Hayes, M. O., and Kana, T. W. 1976. "Terrigenous Clastic Depositional Environments: Some Modern Examples," AAPG Field Course Guidebook and Lecture Notes, Technical Report No. 11-CRD, Coastal Research Division, Department of Geology, University of South Carolina.

Hemsley 1981

Hemsley, J. M. 1981. "Guidelines for Establishing Coastal Survey Base Lines," Coastal Engineering Technical Aid No. 81-15, U.S. Army Engineer Waterways Experiment Station Coastal Engineering Research Center, Vicksburg, MS.

Henkel 1970

Henkel, D. J. 1970. "The Role of Waves in Causing Submarine Landslides," *Geotechnique*, Vol 20, pp 75-80.

Herdendorf 1988

Herdendorf, C. E. 1988. "Classification of Geologic Features in Great Lakes Nearshore and Coastal Areas," Committee report prepared for: Protecting Great Lakes Nearshore and Coastal Diversity Project, International Joint Commission, Windsor, Ontario.

Hicks 1972

Hicks, S. D. 1972. "Changes in Tidal Characteristics and Tidal Datum Planes," *The Great Alaska Earthquake of 1964*, Oceanography and Coastal Engineering, National Academy of Sciences, Washington, DC, pp 310-314.

Hicks 1978

Hicks, S. D. 1978. "An Average Geopotential Sea Level Series for the United States," *Journal of Geophysical Research*, Vol 83, No. C3, pp 1377-1379.

Hicks, Debaugh, and Hickman 1983

Hicks, S. D., Debaugh, H. A., Jr., and Hickman, L. E., Jr. 1983. "Sea-level Variations for the United States 1855-1980," National Oceanic and Atmospheric Administration, Rockville, MD.

Hobson 1977

Hobson, R. D. 1977. "Review of Design Elements for Beach-Fill Evaluation," Technical Memorandum TM-77-6, Coastal Engineering Research Center, U.S. Army Engineer Waterways Experiment Station, Vicksburg, MS.

Hobson 1979

Hobson, R. D. 1979. "Definition and Use of the Phi Grade Scale," Coastal Engineering Technical Aid No. 79-7, U.S. Army Engineer Waterways Experiment Station, Coastal Engineering Research Center, Vicksburg, MS.

Hoffman, Keyes, and Titus 1983

Hoffman, J. S., Keyes, D., and Titus, J. G. 1983. "Projecting Future Sea Level Rise; Methodology, Estimates to the Year 2100, and Research Needs," Report 230-09-007, U.S. Environmental Protection Agency, Washington, DC.

Horikawa 1988

Horikawa, K., ed. 1988. *Nearshore Dynamics and Coastal Processes: Theory, Measurement and Predictive Models*, University of Tokyo Press, Tokyo, Japan.

Horowitz and King 1990

Horowitz, R., and King, J. H. 1990. "NSSDC Data Listing," Report No.: NAS 1.15:102989; NSSDC/WDC-A-R/S-90-06; NASA-TM-102989, Goddard Space Flight Center, National Aeronautics and Space Administration, Greenbelt, MD.

Hotta, Kraus, and Horikawa 1991

Hotta, S., Kraus, N. C., and Horikawa, K. 1991. "Functioning of Multi-row Sand Fences in Forming Foredunes," *Proceedings of Coastal Sediments '91*, American Society of Civil Engineers, New York, pp 261-275.

Houston 1993

Houston, J. R. 1993. "Responding to Uncertainties in Sea Level Rise," *The State of Art of Beach Nourishment, Proceedings of the 1993 National Conference on Beach Preservation Technology*, The Florida Shore & Beach Preservation Association, Tallahassee, FL, pp 358-372.

Howard and Frey 1977

Howard, J. D., and Frey, R. W. 1977. "Characteristic Physical and Biogenic Sedimentary Structures in Georgia Estuaries," *American Association of Petroleum Geologist Bulletin*, Vol 57, pp 1169-1184.

Howd and Birkemeier 1987

Howd, P. A., and Birkemeier, W. A. 1987. "Storm-Induced Morphology Changes During DUCK85," *Coastal*

Sediments '87, American Society of Civil Engineers, New York, NY, pp 834-847.

Howell and Rhee 1990

Howell, G. L., and Rhee, J. P. 1990. "Investigation of Seismic Wave Techniques and Comparative Evaluation of the Seismic Wave Gage at Chetco River, Oregon," Miscellaneous Paper CERC-90-3, U.S. Army Engineer Waterways Experiment Station, Vicksburg, MS.

Hoyt 1967

Hoyt, J. H. 1967. "Barrier Island Formation," *Bulletin of the Geological Society of America*, Vol 78, pp 1125-1136.

Hsu 1988

Hsu, S. A. 1988. *Coastal Meteorology*, Academic Press, Inc., San Diego, CA.

Hubbard, Oertel, and Nummedal 1979

Hubbard, D. K., Oertel, G., and Nummedal, D. 1979. "The Role of Waves and Tidal Currents in the Development of Tidal-Inlet Sedimentary Structures and Sand Body Geometry: Examples from North Carolina, South Carolina, and Georgia," *Journal of Sedimentary Petrology*, Vol 49, No. 4, pp 1073-1092.

Hughes 1988

Hughes, S. A. 1988. "Laboratory Measurement of Spatial and Temporal Suspended Sediment Concentration Under Waves," Miscellaneous Paper CERC-88-1, U.S. Army Engineer Waterways Experiment Station, Vicksburg, MS.

Hughes and Fowler 1990

Hughes, S. A., and Fowler, J. E. 1990. "Midscale Physical Model Validation for Scour at Coastal Structures," Technical Report CERC-90-8, U.S. Army Engineer Waterways Experiment Station, Vicksburg, MS.

Huh and Leibowitz 1986

Huh, O. K., and Leibowitz, S. G. 1986. "User's Guide to Image Processing. Applications of the NOAA Satellite HRPT/AVHRR Data," Technical Report TR 301.86, Remote Sensing and Image Processing Laboratory, Louisiana State University, Baton Rouge, LA.

Hume and Herdendorf 1988

Hume, T. M., and Herdendorf, C. E. 1988. "A Geomorphic Classification of Estuaries and Its Application to Coastal Resource Management - a New Zealand Example," *Journal of Ocean and Shoreline Management*, Vol 11, pp 249-274.

Hume and Herdendorf 1992

Hume, T. M., and Herdendorf, C. E. 1992. "Factors Controlling Tidal Inlet Characteristics on Low Drift Coasts," *Journal of Coastal Research*, Vol 8, No. 2, pp 255-375.

Hunt 1984

Hunt, R. E. 1984. *Geotechnical Engineering Investigation Manual*, McGraw-Hill, New York.

Huschke 1959

Huschke, R. E., ed. 1959. *Glossary of Meteorology*, American Meteorology Society, Boston, MA.

IAHR 1989

IAHR Working Group on Wave Generation and Analysis. 1989. List of Sea-state Parameters, *Journal of the Waterway, Port, and Ocean Engineering*, American Society of Civil Engineers, Vol 115, No. 6, pp 793-809.

Ingle 1966

Ingle, J. C. 1966. *The Movement of Beach Sand*, Elsevier, New York, NY.

Inman 1953

Inman, D. L. 1953. "Areal and Seasonal Variations in Beach and Nearshore Sediments at La Jolla, California," U.S. Army Engineer Waterways Experiment Station, Coastal Engineering Research Center, Technical Memo 39, Vicksburg, MS.

Inman and Chamberlain 1959

Inman, D. L., and Chamberlain, T. K. 1959. "Tracing Beach Sand Movement with Irradiated Quartz," *Journal of Geophysical Research*, Vol 64, No. 1, pp 41-47.

Inman and Nordstrom 1971

Inman, D. L., and Nordstrom, C. E. 1971. "On the Tectonic and Morphological Classification of Coasts," *Journal of Geology*, Vol 79, pp 1-21.

Ismail and Wiegel 1983

Ismail, N. M., and Wiegel, R. L. 1983. "Opposing Wave Effect on Momentum Jet Spreading," *Journal of Waterways, Ports, and Coastal Engineering*, American Society of Civil Engineers, Vol 109, pp 465-483.

Iwagaki and Noda 1963

Iwagaki, Y., and Noda, H. 1963. "Laboratory Studies of Scale Effects in Two Dimensional Beach Processes," *Proceedings of the Eighth Coastal Engineering Conference*, American Society of Civil Engineers, New York, NY, pp 194-210.

John and Sugden 1975

John, B. S., and Sugden, D.E. 1975. "Coastal Geomorphology of High Latitudes," *Prog. Geog.*, Vol 7, pp 53-132.

Johnson 1919

Johnson, D. 1919. *Shore Processes and Shoreline Development*, John Wiley & Sons, New York, NY.

Johnson 1949

Johnson, J. W. 1949. "Scale Effects in Hydraulic Models Involving Wave Motion," *Transactions of the American Geophysical Union*, Vol 30, No. 4, pp 517-525.

Jopling 1966

Jopling, A. V. 1966. "Some Principles and Techniques Used in Reconstructing the Hydraulic Parameters of a Paleoflow Regime," *Journal of Sedimentary Petrology*, Vol 36, pp 5-49.

Joshi and Taylor

Joshi, P. B., and Taylor, R. B. 1983. "Circulation Induced by Tidal Jets," *Journal of Waterway, Port, Coastal and Ocean Engineering*, American Society of Civil Engineers, Vol 109, No. 4, pp 445-464.

Judge 1970

Judge, C. W. 1970. "Heavy Minerals in Beach and Stream Sediments as Indicators of Shore Processes Between Monterey and Los Angeles, California," Technical Memorandum No. 33, U.S. Army Engineer Waterways Experiment Station, Coastal Engineering Research Center, Vicksburg, MS.

Kajima, Shimizu, Maruyama, and Saito 1983

Kajima, R., Shimizu, T., Maruyama, K., and Saito, S. 1983. "Experiments of Beach Profile Change with a Large Wave Flume," *Proceedings 18th Coastal Engineering Conf.*, American Society of Civil Engineers, New York, NY, pp 1385-1404.

Kamphius 1987

Kamphius, J. W. 1987. "On the Recession of Glacial Till Bluffs," *Journal of Waterway, Port, Coastal and Ocean Engineering*, Vol 113, No. 2, pp 60-73.

Kamphius 1990

Kamphius, J. W. 1990. "Influence of Sand or Gravel on the Erosion of Cohesive Sediment," *Journal of Hydraulic Research*, Vol 28, No. 1, pp 43-53.

Kapp 1969

Kapp, R. O. 1969. *How to Know Pollen and Spores*, Brown, Dubuque, IA.

Kay 1990

Kay, R. W. 1990. "Bogoslof, Eastern Aleutian Islands," *Volcanoes of North America: United States and Canada*, C. A. Wood and J. Kienle, eds., Cambridge University Press, Cambridge, UK, p 41.

Kerwin and Pedigo 1971

Kerwin, J. A., and Pedigo, R. A. 1971. "Synecology of a Virginia Salt Marsh," *Chesapeake Science*, Vol 12, pp 125-130.

Keulegan 1945

Keulegan, G. H. 1945. "Depths of Offshore Bars," Engineering Notes No. 8, Beach Erosion Board, U.S. Army Engineer Waterways Experiment Station, Vicksburg, MS.

Keulegan 1948

Keulegan, G. H. 1948. "An Experimental Study of Submarine Sand Bars," Technical Report No. 3, Beach Erosion Board, U.S. Army Engineer Waterways Experiment Station, Vicksburg, MS.

Keulegan 1967

Keulegan, G. H. 1967. "Tidal Flow in Entrances: Water-level Fluctuations of Basins in Communication with Seas," Technical Bulletin 14, Committee on Tidal Hydraulics, U.S. Army Corps of Engineers, Washington, DC.

Kieslich 1977

Kieslich, J. M. 1977. "A Case History of Port Mansfield Channel, Texas," General Investigation of Tidal Inlets Report 12, U.S. Army Engineer Waterways Experiment Station, Vicksburg, MS.

King 1972a

King, C. A. M. 1972a. *Beaches and Coasts*, 2nd ed., Edward Arnold, London, UK.

King 1972b

King, C.A.M. 1972b. "The Relationship Between Wave Incidence, Wind Direction, and Beach Changes at Marsden Bay, Co. Durham," *Transactions of the Institute British Geography*, Vol 19, pp 13-23.

Kinsman 1965

Kinsman, B. 1965. *Wind Waves*, Prentice-Hall, Englewood Cliffs, NJ.

Knauss 1978

Knauss, J. A. 1978. *Introduction to Physical Oceanography*, Prentice-Hall, Englewood Cliffs, NJ.

Knowles and Gorman 1991

Knowles, S. C., and Gorman, L. T. 1991. "Historical Coastal Morphodynamics at St. Marys Entrance and Vicinity, Florida, U.S.A.," *Proceedings Coastal Sediments '91*. American Society of Civil Engineers, New York, NY, pp 1447-61.

Knutson 1976

Knutson, P. L. 1976. "Summary of CERC Research on Uses of Vegetation for Erosion Control," *Proceedings of Great Lakes Vegetation Workshop*, Great Lakes Basin Commission and USDA Soil Conservation Service, pp 31-36.

Knutson 1978

Knutson, P. L. 1978. "Planting Guidelines for Dune Creation and Stabilization," *Proceedings of Symposium on Technical, Environmental, Socioeconomic and Regulatory Aspects of Coastal Zone Planning and Management*, American Society of Civil Engineers, Vol 2, pp 762-779.

Kolb and van Lopik 1966

Kolb, C. R., and van Lopik, J. R. 1966. "Depositional Environments of the Mississippi River Deltaic Plain-Southeastern Louisiana," In: *Deltas in Their Geologic Framework*, Houston Geological Society, Houston, TX, pp 17-61.

Komar 1976

Komar, P. D. 1976. *Beach Processes and Sedimentation*, Prentice-Hall, Englewood Cliffs, NJ.

Komar 1983

Komar, P. D. 1983. "Computer Models of Shoreline Changes," *CRC Handbook of Coastal Processes and Erosion*, P. D. Komar, ed., CRC Press, Inc., Boca Raton, FL, pp 205-216.

Komar 1992

Komar, P. D. 1992. "Ocean Processes and Hazards Along the Oregon Coast," *Oregon Geology*, Vol 54, No. 1, pp 3-19.

Komar and Enfield 1987

Komar, P. D., and Enfield, D. B. 1987. "Short-Term Sea-Level Changes on Coastal Erosion," *Sea-Level Fluctuations and Coastal Evolution*, Special Publication No. 41, D. Nummedal, O. H. Pilkey, and J. D. Howard,

eds., Society of Economic Paleontologists and Mineralogists, Tulsa, OK, pp 17-28.

Komar, Clemens, Li, and Shih 1987

Komar, P. D., Clemens, K. E., Li, Z., and Shih, S. M. 1989. "The Effects of Selective Sorting on Factor Analyses of Heavy Mineral Assemblages," *Journal of Sedimentary Petrology*, Vol 59, pp 590-596.

Komar et al. 1991

Komar, P. D., et al. (Scientific Committee on Ocean Research (SCOR) Working Group 89.) 1991. "The Response of Beaches to Sea-Level Changes: A Review of Predictive Models," *Journal of Coastal Research*, Vol 7, No. 3, pp 895-921.

Kraft and Chrzastowski 1985

Kraft, J. C., and Chrzastowski, M. J. 1985. "Coastal Stratigraphic Sequences," *Coastal Sedimentary Environments*, Davis, R. A., Jr., ed., Springer-Verlag, New York, NY, pp 625-663.

Kraus 1987

Kraus, N. C. 1987. "Application of Portable Traps for Obtaining Point Measurements of Sediment Transport Rates In the Surf Zone," *Journal of Coastal Research*, Vol 3, No. 2, pp 139-152.

Kraus 1989

Kraus, N. C. 1989. "Beach Change Modeling and the Coastal Planning Process," *Coastal Zone '89: Proceedings of the Sixth Symposium on Coastal and Ocean Management*, Charleston, SC, American Society of Civil Engineers, New York, NY, pp 553-567.

Kraus 1990

Kraus, N. C., ed. 1990. "Shoreline Change and Storm-Induced Beach Erosion Modeling: A Collection of Seven Papers," Miscellaneous Paper CERC-90-2, U.S. Army Engineer Waterways Experiment Station, Vicksburg, MS.

Kraus 1992

Kraus, N. C. 1992. "Engineering Approaches to Coastal Sediment Transport Processes," *Proceedings of the Short Course on Design and Reliability of Coastal Structures*, 23rd International Conference on Coastal Engineering, 1-3 October, Venice, Italy, pp 175-209.

Kraus and Dean 1987

Kraus, N. C., and Dean, J. L. 1987. "Longshore Sand Transport Rate Distribution Measured By Sediment Trap," *Coastal Sediments '87*, New Orleans, LA, American Society of Civil Engineers, New York, NY, pp 891-896.

Kraus and Harikai 1983

Kraus, N. C., and Harikai, S. 1983. "Numerical Model of the Shoreline Change at Oarai Beach," *Coastal Engineering*, Vol 7, No. 1, pp 1-28.

Kraus and Larson 1988

Kraus, N. C., and Larson, M. 1988. "Prediction of Initial Profile Adjustment of Nourished Beaches to Wave Action," *Proceedings of Beach Preservation Technology '88*, Florida Shore and Beach Preservation Association, Inc., pp 125-137.

Kraus and Mason 1993

Kraus, N. C., and Mason, J. M. 1993. "Discussion of Prediction of Storm/Normal Beach Profiles," *Journal of Waterway, Port, Coastal and Ocean Engineering*.

Kraus, Gorman, and Pope, in preparation

Kraus, N. C., Gorman, L. T., and Pope, J. "Kings Bay Coastal and Estuarine Physical Monitoring and Evaluation Program: Coastal Studies," in preparation, U.S. Army Engineer Waterways Experiment Station, Vicksburg, MS (in 2 volumes).

Kraus, Larson, and Kriebel 1991

Kraus, N. C., Larson, M., and Kriebel, D. L. 1991. "Evaluation of Beach Erosion and Accretion Predictors," *Proceedings of Coastal Sediments '91*, American Society of Civil Engineers, New York, NY, pp 572-587.

Kraus, Smith, and Sollitt 1992

Kraus, N. C., Smith, J. M., and Sollitt, C. K. 1992. "SUPERTANK Laboratory Data Collection Project," *Proceedings of the 23rd Coastal Engineering Conference*, American Society of Civil Engineers, New York, NY, pp 2191-2204.

Krauss 1978

Krauss, J. A. 1978. *Introduction to Physical Oceanography*, Prentice-Hall, Inc., Englewood Cliffs, NJ.

Kriebel 1987

Kriebel, D. L. 1987. "Beach Recovery Following Hurricane Elena," *Proceedings of Coastal Sediments '87*, American Society of Civil Engineers, New York, NY, pp 990-1005.

Kriebel and Dean 1985

Kriebel, D. L., and Dean, R. G. 1985. "Numerical Simulation of Time-Dependent Beach and Dune Erosion," *Coastal Engineering*, Vol 9, pp 221-245.

Kriebel, Kraus, and Larson 1991

Kriebel, D. L., Kraus, N. C., and Larson, M. 1991. "Engineering Methods for Predicting Beach Profile Response," *Proceedings of Coastal Sediments '91*, American Society of Civil Engineers, New York, NY, pp 557-571.

Krumbein 1957

Krumbein, W. C. 1957. "A Method for Specification of Sand for Beach Fills," Technical Memorandum No. 102, Beach Erosion Board, U.S. Army Engineer Waterways Experiment Station, Vicksburg, MS.

Krumbein and Sloss 1963

Krumbein, W. C., and Sloss, L. L. 1963. *Stratigraphy and Sedimentation*, 2nd ed., W. H. Freeman and Company, San Francisco, CA.

Kuhn and Shepard 1984

Kuhn, G. G., and Shepard, F. P. 1984. *Sea Cliffs, Beaches, and Coastal Valleys of San Diego County; Some Amazing Histories and Some Horrifying Implications*, University of California Press, Berkeley, CA.

Lampman 1993

Lampman, J. L. 1993. "Bibliography of Remote Sensing Techniques Used in Wetland Research," Technical Report WRP-SM-2, U.S. Army Engineer Waterways Experiment Station, Vicksburg, MS.

Larson 1991

Larson, M. 1991. "Equilibrium Profile of a Beach with Varying Grain Size," *Coastal Sediments '91*, American Society of Civil Engineers, New York, NY, pp 905-919.

Larson and Kraus 1989a

Larson, M., and Kraus, N. C. 1989a. "SBEACH: Numerical Model for Simulating Storm-Induced Beach Change; Report 1, Empirical Foundation and Model Development." Technical Report CERC-89-9, U.S. Army Engineer Waterways Experiment Station, Vicksburg, MS.

Larson and Kraus 1989b

Larson, M., and Kraus, N. C. 1989b. "Prediction of Beach Fill Response to Varying Waves and Water Level," *Proceedings of Coastal Zone '89*, American Society of Civil Engineers, New York, NY, pp 607-621.

Lauff 1967

Lauff, G. H., ed. 1967. *Estuaries*, American Association for the Advancement of Science, Pub. No. 83, Washington, DC.

Leatherman 1979

Leatherman, S. P., ed. 1979. *Barrier Islands from the Gulf of St. Lawrence to the Gulf of Mexico*, Academic Press, New York, NY.

Leatherman 1984

Leatherman, S. P. 1984. "Shoreline Evolution of North Assateague Island, Maryland," *Shore and Beach*, Vol 52, pp 3-10.

Leeder 1982

Leeder, M. R. 1982. *Sedimentology: Process and Product*, George Allen and Unwin, London, UK.

Leenknecht, Szuwalski, and Sherlock 1992

Leenknecht, D. A., Szuwalski, A., and Sherlock, A. R. 1992. "Automated Coastal Engineering System, User's Guide," Coastal Engineering Research Center, U.S. Army Engineer Waterways Experiment Station, Vicksburg, MS.

Leick 1990

Leick, A. 1990. *GPS Satellite Surveying*, John Wiley and Sons, New York, NY.

Le Méhauté 1976

Le Méhauté, B. 1976. *An Introduction to Hydrodynamics and Water Waves*, Springer-Verlag, New York, NY.

Leveson 1980

Leveson, D. 1980. *Geology and the Urban Environment*, Oxford University Press, New York, NY.

Lewis 1984

Lewis, D. W. 1984. *Practical Sedimentology*, Hutchinson Ross, Stroudsburg, PA.

Lillesand and Kiefer 1987

Lillesand, T. M., and Kiefer, R. W. 1987. *Remote Sensing and Image Interpretation*, 2nd ed., John Wiley and Sons, New York, NY.

Lillycrop and Banic 1992

Lillycrop, W. J., and Banic, J. R. 1992. "Advancements in the U.S. Army Corps of Engineers Hydrographic Survey Capabilities: The SHOALS System," *Marine Geodesy*, Vol 15, pp 177-185.

Linsley and Kohler 1982

Linsley, R. K., Jr., and Kohler, M. A. 1982. *Hydrology for Engineers*, 3rd ed., McGraw Hill Book Company, New York, NY.

Lisitzin 1974

Lisitzin, E. 1974. *Sea-Level Changes*, Elsevier Oceanography Series, 8, Elsevier Scientific Publishing Company, Amsterdam, The Netherlands.

Longuet-Higgins, Cartwright, and Smith 1963

Longuet-Higgins, M. S., Cartwright, D. E., and Smith, N. D. 1963. "Observations of the Directional Spectrum of Sea Waves Using the Motions of a Floating Buoy," *Ocean Wave Spectra*, Prentice-Hall, Englewood Cliffs, NJ, pp 111-136.

Lutgens and Tarbuck 1982

Lutgens, F. K., and Tarbuck, E. J. 1982. *The Atmosphere: An Introduction to Meteorology*, Prentice Hall, Englewood Cliffs, NJ.

Lyles, Hickman, and Debaugh 1988

Lyles, S. D., Hickman, L. E., Jr., and Debaugh, H. A., Jr. 1988. "Sea Level Variations for the United States, 1855-1986," U.S. Department of Commerce, National Oceanic and Atmospheric Administration, National Ocean Service, Rockville, MD.

Macdonald 1972

Macdonald, G. A. 1972. *Volcanoes*, Prentice-Hall, Inc., Englewood Cliffs, NJ.

Mariolakos 1990

Mariolakos, I. 1990. "The Impact of Neotectonics with Regard to Canals, Pipelines, Dams, Open Reservoirs, etc. in Active Areas: The Case of the Hellenic Arc," *Greenhouse Effect, Sea Level and Drought*, Proceedings of the NATO Advanced Research Workshop on Geohydrological Management of Sea Level and Mitigation of Drought (1989), R. Paepe, R. W. Fairbridge, and S. Jelgersma, eds., Kluwer Academic Publishers, Dordrecht, The Netherlands, pp 427-438.

Mason and Folk 1958

Mason, C. C., and Folk, R. L. 1958. "Differentiation of Beach, Dune, and Aeolian Flat Environments by Size Analysis, Mustang Island, Texas," *Journal of Sedimentary Petrology*, Vol 28, pp 211-226.

May and Britsch 1987

May, J. R., and Britsch, L. D. 1987. "Geological Investigation of the Mississippi River Delta Plain: Land Loss and Land Accretion," Technical Report GL-87-13, U.S. Army Engineer Waterways Experiment Station, Vicksburg, MS.

McBride and Moslow 1991

McBride, R. A., and Moslow, T. F. 1991. "Origin, Evolution, and Distribution of Shoreface Sand Ridges, Atlantic Inner Shelf, U.S.A.," *Marine Geology*, Vol 97, pp 57-85.

McBride, Hiland, Penland, Williams, Byrnes, Westphal, Jaffe, and Sallenger 1991

McBride, R. A., Hiland, M. W., Penland, S., Williams, S. J., Byrnes, M. R., Westphal, K. A., Jaffe, B., and Sallenger, A. H., Jr. 1991. "Mapping Barrier Island Changes in Louisiana: Techniques, Accuracy, and Results," *Proceedings Coastal Sediments '91*. American Society of Civil Engineers, New York, NY, pp 1011-26.

McCullough 1980

McCullough, J. R. 1980. "Survey of Techniques for Measuring Currents Near The Ocean Surface," *Air-Sea Interaction-Instruments and Methods*, F. Dobson, L. Hasse, and R. Davis, eds., Plenum Press, New York, NY, pp 105-126.

McIntire 1958

McIntire, W. G. 1958. "Correlation of Prehistoric Settlements and Delta Development," Louisiana State University Coastal Studies Series No. 1, University Press, Baton Rouge, LA.

McKinney 1974

McKinney, T. F. 1974. "Large-scale Current Lineations on the Great Egg Shoal Massif, New Jersey Shelf: Investigation by Side-Scan Sonar," *Journal of Sedimentary Petrology*, Vol 17, pp 79-102.

McKinney, Stubblefield, and Swift 1974

McKinney, T. F., Stubblefield, W. L., and Swift, D. J. P. 1974. "Large-scale Current Lineations on the Central New Jersey Shelf: Investigation by Side-Scan Sonar," *Marine Geology*, Vol 17, pp 79-102.

McMaster 1960

McMaster, R. L. 1960. "Mineralogy as an Indicator of Beach and Sand Movement along the Rhode Island Shore," *Journal of Sedimentary Petrology*, Vol 30, No. 3, pp 404-413.

Meade 1969

Meade, R. H. 1969. "Landward Transport of Bottom Sediments in the Estuaries of the Atlantic Coastal Plain," *Journal of Sedimentary Petrology*, Vol 39, pp 229-234.

Meade and Emery 1971

Meade, R. H., and Emery, K. O. 1971. "Sea-Level as Affected by River Runoff, Eastern United States," *Science*, Vol 173, pp 425-428.

Meisburger 1972

Meisburger, E. P. 1972. "Geomorphology and Sediments of the Chesapeake Bay Entrance," Technical Memorandum No. 38, Coastal Engineering Research Center, U.S. Army Engineer Waterways Experiment Station, Vicksburg, MS.

Meisburger 1976

Meisburger, E. P. 1976. "Geomorphology and Sediments of Western Massachusetts Bay," Technical Paper No. 76-3, Coastal Engineering Research Center, U.S. Army Engineer Waterways Experiment Station, Vicksburg, MS.

Meisburger 1977

Meisburger, E. P. 1977. "Sand Resources on the Inner Continental Shelf of the Cape Fear Region," Miscellaneous Report No. 77-11, Coastal Engineering Research Center, U.S. Army Engineer Waterways Experiment Station, Vicksburg, MS.

Meisburger 1979

Meisburger, E. P. 1979. "Reconnaissance Geology of the Inner Continental Shelf, Cape Fear Region, North Carolina," Technical Report No. 79-3, Coastal Engineering Research Center, U.S. Army Engineer Waterways Experiment Station, Vicksburg, MS.

Meisburger 1990

Meisburger, E. P. 1990. "Exploration and Sampling Methods for Borrow Areas," Technical Report CERC-90-18, U.S. Army Engineer Waterways Experiment Station, Vicksburg, MS.

Meisburger 1993

Meisburger, E. P. 1993. "Review of Geologic Data Sources for Coastal Sediment Budgets," Instruction Report CERC-93-1, U.S. Army Engineer Waterways Experiment Station, Vicksburg, MS.

Meisburger and Duane 1971

Meisburger, E. P., and Duane, D. B. 1971. "Geomorphology and Sediments of the Inner Continental Shelf,

Palm Beach to Cape Kennedy, Florida," Technical Memorandum No. 34, Coastal Engineering Research Center, U.S. Army Engineer Waterways Experiment Station, Vicksburg, MS.

Meisburger and Field 1975

Meisburger, E. P., and Field, M. E. 1975. "Geomorphology, Shallow Structure, and Sediments of the Florida Inner Continental Shelf, Cape Canaveral to Georgia," Technical Memorandum No. 54, Coastal Engineering Research Center, U.S. Army Engineer Waterways Experiment Station, Vicksburg, MS.

Meisburger and Williams 1980

Meisburger, E. P., and Williams, S. J. 1980. "Sand Resources on the Inner Continental Shelf of the Cape May Region, New Jersey," Miscellaneous Report 80-4, Coastal Engineering Research Center, U.S. Army Engineer Waterways Experiment Station, Vicksburg, MS.

Meisburger and Williams 1981

Meisburger, E. P., and Williams, S. J. 1981. "Use of Vibratory Coring Samplers for Sediment Surveys," Coastal Engineering Technical Aid No. 81-9, Coastal Engineering Research Center, U.S. Army Engineer Waterways Experiment Station, Vicksburg, MS.

Meisburger and Williams 1982

Meisburger, E. P., and Williams, S. J. 1982. "Sand Resources on the Inner Continental Shelf Off the Central New Jersey Coast," Miscellaneous Report No. 82-10, Coastal Engineering Research Center, U.S. Army Engineer Waterways Experiment Station, Vicksburg, MS.

Meisburger, Williams, and Prins 1979

Meisburger, E. P., Williams, S. J., and Prins, D. A. 1979. "Sand Resources of Southeastern Lake Michigan," Miscellaneous Report No. 79-3, Coastal Engineering Research Center, U.S. Army Engineer Waterways Experiment Station, Vicksburg, MS.

Metha 1986

Metha, A. J., ed. 1986. *Estuarine Cohesive Sediment Dynamics*, Lecture Notes on Coastal and Estuarine Studies, Vol 14, Springer-Verlag, New York, NY.

Middleton 1965

Middleton, G. V., Compiler. 1965. *Primary Sedimentary Structures and Their Hydrodynamic Interpretation*, Society of Economic Paleontologists and Mineralogists Special Publication No. 12, Tulsa, OK.

Middleton 1977

Middleton, G. V., Compiler. 1977. *Sedimentary Processes: Hydraulic Interpretation of Primary Sedimentary Structures*, Reprint Series Number 3, Society of Economic Paleontologists and Mineralogists, Tulsa, OK.

Middleton and Southard 1984

Middleton, G. V., and Southard, J. B. 1984. "Mechanics of Sediment Transport," Society for Sedimentary Geology (SEPM), Short Course No. 3, Tulsa, OK.

Milliman and Emery 1968

Milliman, J. D., and Emery, K. O. 1968. "Sea Levels During the Past 35,000 Years," *Science*, Vol 162, pp 1121-1123.

Minsinger 1988

Minsinger, W. E., ed. 1988. *The 1938 Hurricane, an Historical and Pictorial Summary*, Blue Hill Observatory, East Milton, MA.

Moore 1982

Moore, B. D. 1982. "Beach Profile Evolution in Response to Changes in Water Level and Wave Height," M. S. thesis, University of Delaware, Newark, DE.

Moore and Clague 1992

Moore, J. G., and Clague, D. A. 1992. "Volcano Growth and Evolution of the Island of Hawaii," *Geological Society of America Bulletin*, Vol 104, No. 11, pp 1471-1484.

Morang 1990

Morang, A. 1990. "Quality Control and Management of Oceanographic Wave Gage Data," Instruction Report CERC-90-1, U.S. Army Engineer Waterways Experiment Station, Vicksburg, MS.

Morang 1992a

Morang, A. 1992a. "A Study of Geologic and Hydraulic Processes at East Pass, Destin, Florida," (in 2 volumes), Technical Report CERC-92-5, U.S. Army Engineer Waterways Experiment Station, Vicksburg, MS.

Morang 1992b

Morang, A. 1992b. "Inlet Migration and Geologic Processes at East Pass, Florida," *Journal of Coastal Research*, Vol 8, No. 2, pp 457-481.

Morang 1993

Morang, A. 1993. "Geologic and Physical Processes at a Gulf of Mexico Tidal Inlet, East Pass, Florida," Ph.D. diss., Louisiana State University, Baton Rouge, LA.

Morang and McMaster 1980

Morang, A., and McMaster, R. L. 1980. "Nearshore Bedform Patterns Along Rhode Island from Side-Scan Sonar Surveys," *Journal of Sedimentary Petrology*, Vol 50, No. 3, pp 831-840.

Morang, Mossa, and Larson 1993

Morang, A., Mossa, J., and Larson, R. J. 1993. "Technologies for Assessing the Geologic and Geomorphic History of Coasts," Technical Report CERC-93-5, U.S. Army Engineer Waterways Experiment Station, Vicksburg, MS.

Morrison 1974

Morrison, S. E. 1974. *The European Discovery of America; The Southern Voyages*, Vol 2, Little Brown & Company, Boston, MA.

Morton 1979

Morton, R. A. 1979. "Temporal and Spatial Variations in Shoreline Changes and Their Implications, Examples from the Texas Gulf Coast," *Journal of Sedimentary Petrology*, Vol 99, No. 3, pp 1101-1112.

Mossa, Meisburger, and Morang 1992

Mossa, J., Meisburger, E. P., and Morang, A. 1992. "Geomorphic Variability in the Coastal Zone," Technical Report CERC-92-4, U.S. Army Engineer Waterways Experiment Station, Vicksburg, MS.

Nairn 1992

Nairn, R. B. 1992. "Designing for Cohesive Shores," Coastal Engineering in Canada, Queens University, Kingston, Ontario.

National Research Council, Board on Atmospheric Sciences and Climate 1983

National Research Council, Board on Atmospheric Sciences and Climate. 1983. *Changing Climate, Report of the Carbon Dioxide Assessment Committee*, National Academy Press, Washington, DC.

National Research Council, Committee on Engineering Implications of Changes in Relative Mean Sea Level 1987

National Research Council, Committee on Engineering Implications of Changes in Relative Mean Sea Level. 1987. *Responding to Changes in Sea Level*, National Academy Press, Washington, DC.

Neiheisel 1962

Neiheisel, J. 1962. "Heavy-Mineral Investigation of Recent and Pleistocene Sands of Lower Coastal Plain of Georgia," *Geological Society of America Bulletin*, Vol 73, pp 365-374.

Nelson 1972

Nelson, B. W., ed. 1972. *Environmental Framework of Coastal Plain Estuaries*, Geological Society of America Memoir 133, Boulder, CO.

Nelson and Coakley 1974

Nelson, D. E., and Coakley, J. P. 1974. "Techniques for Tracing Sediment Movement," Scientific Series No. 32, Inland Waters Directorate, Canada Centre for Inland Waters, Burlington, Ontario.

Neumann, Jarvinen, Pike, and Elms 1987

Neumann, C. J., Jarvinen, B. R., Pike, A. C., and Elms, J. D. 1987. *Tropical Cyclones of the North Atlantic Ocean, 1871-1986*, Third rev., Historical Climatology Series 6-2, National Climatic Data Center, Asheville, NC.

Nichols 1968

Nichols, R. L. 1968. "Coastal Geomorphology, McMurdo Sound, Antarctica," *Journal of Glaciology*, Vol 51, pp 694-708.

Nichols and Biggs 1985

Nichols, M. M., and Biggs, R. B. 1985. "Estuaries," *Coastal Sedimentary Environments*, R. A. Davis, Jr., ed., 2nd ed., Springer-Verlag, New York, NY, pp 77-186.

Nicholls and Webber 1987

Nicholls, R. J., and Webber, N. B. 1987. "Aluminum Pebble Tracer Studies on Hurst Castle Spit," *Coastal Sediments '87*, American Society of Civil Engineers, New York, NY, pp 1563-1577.

Niedoroda, Swift, and Hopkins 1985

Niedoroda, A. W., Swift, D. J. P., and Hopkins, T. S. 1985. "The Shoreface," *Coastal Sedimentary Environments*, R. A. Davis, Jr., ed., 2nd ed., Springer-Verlag, New York, NY.

NOAA 1976

National Oceanic and Atmospheric Administration. 1976. *Hydrographic Manual*, 4th ed., U.S. Department of Commerce, Rockville, MD.

NOAA 1977

National Oceanic and Atmospheric Administration. 1977. "Some Devastating North Atlantic Hurricanes of the 20th

Century," Booklet NOAA/PA 77019, U.S. Government Printing Office, Washington, DC.

Nordstrom and Inman 1975

Nordstrom, C. E., and Inman, D. L. 1975. "Sand Level Changes on Torrey Pines Beach, California," U.S. Army Engineer Waterways Experiment Station, Coastal Engineering Research Center, Vicksburg, MS.

Nummedal 1983

Nummedal, D. 1983. "Barrier Islands," *CRC Handbook of Coastal Processes and Erosion*, P. D. Komar, ed., CRC Press, Inc., Boca Raton, FL, pp 77-121.

Nummedal and Fischer 1978

Nummedal, D., and Fischer, I. A. 1978. "Process-Response Models for Depositional Shorelines: The German and the Georgia Bights," *Proceedings of the Sixteenth Conference on Coastal Engineering*, American Society of Civil Engineers, New York, NY, pp 1215-1231.

Nummedal and Humphries 1978

Nummedal, D., and Humphries, S. M. 1978. "Hydraulics and Dynamics of North Inlet, South Carolina, 1975-76," General Investigation of Tidal Inlets Report 16, U.S. Army Engineer Waterways Experiment Station, Vicksburg, MS.

Nummedal and Penland 1981

Nummedal, D., and Penland, S. 1981. "Sediment Dispersal in Norderneyer Seegat, West Germany," *Holocene Marine Sedimentation in the North Sea Basin*, S. D. Nio, R. T. E. Schuttenhelm, and C. E. van Weering, eds., International Association of Sedimentologists Special Publication No. 5, pp 187-210.

Nummedal, Pilkey, and Howard, eds. 1987

Nummedal, D., Pilkey, O. H., and Howard, J. D., eds. 1987. *Sea-Level Fluctuations and Coastal Evolution*, Special Publication No. 41, Society of Economic Paleontologists and Mineralogists, Tulsa, OK.

O'Brien 1931

O'Brien, M. P. 1931. "Estuary Tidal Prisms Related to Entrance Areas," *Civil Engineering*, Vol 1, pp 738-739.

O'Brien 1972

O'Brien, M. P. 1972. "Equilibrium Flow Areas of Inlets on Sandy Coasts," *Proceedings of the Thirteenth Coastal Engineering Conference*, July 10-14, Vancouver, BC, Canada, American Society of Civil Engineers, New York, NY, Vol II, pp 761-780.

O'Brien 1976

O'Brien, M. P. 1976. "Notes on Tidal Inlets on Sandy Shores," General Investigation of Tidal Inlets Report 5, U.S. Army Engineer Waterways Experiment Station, Vicksburg, MS.

Oertel 1982

Oertel, G. F. 1982. "Inlets, Marine-Lagoonal and Marine Fluvial," *The Encyclopedia of Beaches and Coastal Environments*, M. L. Schwartz, ed., Hutchinson Ross Publishing Company, Strausburg, PA, p 489.

Oertel 1988

Oertel, G. F. 1988. "Processes of Sediment Exchange Between Tidal Inlets, Ebb Deltas, and Barrier Islands," *Hydrodynamics and Sediment Dynamics of Tidal Inlets*, Lecture Notes on Coastal and Estuarine Studies, Vol 29, D. G. Aubrey and L. Weishar, eds., Springer-Verlag, New York, NY, pp 297-318.

Oldfield 1981

Oldfield, F. 1981. "Peats and Lake Sediments: Formation, Stratigraphy, Description, and Nomenclature," *Geomorphological Techniques*, A. Goudie, ed., George Allen and Unwin, London, UK, pp 306-326.

Oldfield and Appleby 1984

Oldfield, F., and Appleby, P. G. 1984. "Empirical Testing of ²¹⁰Pb-Dating Models For Lake Sediments," *Lake Sediments and Environmental History*, E. Y. Haworth and J. W. G. Lund, eds., Leicester University Press, Leicester, UK, pp 3-124.

Oregon 1973

Oregon. 1973. "Oregon Estuaries," State of Oregon Division of State Lands, Salem, OR.

Orme 1985

Orme, A. R. 1985. "California," *The World's Coastline*, E. C. Bird, and M. L. Schwartz, eds., Van Nostrand Reinhold, New York, NY, pp 27-36.

Otvos 1970

Otvos, E. G., Jr. 1970. "Development and Migration of Barrier Islands, Northern Gulf of Mexico," *Bulletin of the Geological Society of America*, Vol 81, pp 241-246.

Otvos 1981

Otvos, E. G., Jr. 1981. "Barrier Island Formation Through Nearshore Aggravation - Stratigraphic and Field Evidence," *Marine Geology*, Vol 43, pp 195-243.

Owen 1977

Owen, M. W. 1977. "Problems in Modeling of Transport, Erosion, and Deposition of Cohesive Sediments,"

The Sea, E. D. Goldberg, I. N. McCave, J. J. O'Brien, and J. H. Steele, eds., Vol 6, pp 515-537.

Pattullo 1966

Pattullo, J. G. 1966. "Seasonal Changes in Sea Level," *The Sea*, M. N. Hill, ed., International Publishing, New York, NY, pp 485-496.

Payton 1977

Payton, C. E., ed. 1977. *Seismic Stratigraphy - Applications to Hydrocarbon Exploration*, Memoir 26, American Association of Petroleum Geologists, Tulsa, OK.

Penland and Boyd 1981

Penland, S., and Boyd, R. 1981. "Shoreline Changes on the Louisiana Barrier Coast," *Proceedings of the Oceans '81 Conference*, Boston, Massachusetts, September 16-18, pp 209-219.

Pennant-Rea 1994

Pennant-Rea, R., ed. 1994. "Chainsaw Massacres," *The Economist*, Vol 331, No. 7869, p 39.

Peterson, Scheidegger, Komar, and Niem 1984

Peterson, C., Scheidegger, K., Komar, P. D., and Niem, W. 1984. "Sediment Composition and Hydrography in Six High-Gradient Estuaries of the Northwestern United States," *Journal of Sedimentary Petrology*, Vol 54, No. 1, pp 86-97.

Pethick 1984

Pethick, J. 1984. *An Introduction to Coastal Geomorphology*, Edward Arnold Publishers, London, UK.

Pettijohn 1975

Pettijohn, F. J. 1975. *Sedimentary Rocks*, Harper and Row, New York, NY.

Pierce, Obradovich, and Friedman 1976

Pierce, K.L., Obradovich, J. D., and Friedman, I. 1976. "Obsidian Hydration Dating and Correlation of Bull Lake and Pinedale Glaciations Near West Yellowstone, Montana," *Geological Society of America Bulletin*, Vol 87, pp 703-710.

Pilkey 1993

Pilkey, O. H. 1993. "Can We Predict the Behavior of Sand: In a Time and Volume Framework of Use to Humankind?" *Journal of Coastal Research*, Vol 9, No. 1, pp iii-iv.

Pilkey and Field 1972

Pilkey, O. H., and Field, M. E. 1972. "Onshore Transportation of Continental Shelf Sediment: Atlantic South-eastern United States," *Shelf Sediment Transport*, D. J. Swift, D. B. Duane, and O. H. Pilkey, eds., Dowden, Hitchinson, & Ross, Stroudsburg, PA.

Pilkey, Young, Riggs, Smith, Wu, and Pilkey 1993

Pilkey, O. H., Young, R. S., Riggs, S. R., Smith, A. W. S., Wu, H., and Pilkey, W. D. 1993. "The Concept of Shoreface Profile of Equilibrium: A Critical Review," *Journal of Coastal Research*, Vol 9, No. 1, pp 225-278.

Pinkel 1980

Pinkel, R. 1980. "Acoustic Doppler Techniques," *Air-Sea Interaction-Instruments and Methods*, F. Dobson, L. Hasse, and R. Davis, eds., Plenum Press, New York, NY, pp 171-199.

Pirazzoli 1986

Pirazzoli, P. A. 1986. "Secular Trends of Relative Sea Level (RSL) Changes Indicated by Tide-gage Records," *Journal of Coastal Research*, Special Issue, No. 1, pp 1-26.

Pirazzoli 1991

Pirazzoli, P. A. 1991. *World Atlas of Sea-Level Changes*, Elsevier Scientific Publishers, Amsterdam, The Netherlands.

Plafker and Kachadoorian 1966

Plafker, G., and Kachadoorian, R. 1966. "Geologic Effects of the March 1964 Earthquake and Associated Seismic Sea Waves on Kodiak and Nearby Islands, Alaska," Geological Survey Professional Paper 543-D, U.S. Government Printing Office, Washington, DC.

Pollock 1995

Pollock, C. E. 1995. "Helicopter-Borne Nearshore Survey System, A Valuable Tool in Difficult Survey Areas," *Journal of Coastal Research*, Vol 11, No. 2.

Pond and Pickard 1983

Pond, S., and Pickard, G. L. 1983. *Introductory Dynamical Oceanography*, 2nd ed., Pergamon Press, Oxford, England, UK.

Press and Siever 1986

Press, F., and Siever, R. 1986. *Earth*, 4th. ed., W. H. Freeman and Company, New York, NY.

Price 1968

Price, W. A. 1968. "Tidal Inlets," *The Encyclopedia of Geomorphology*, Encyclopedia of Earth Sciences Series, Vol III, R. W. Fairbridge, ed., Reinhold Book Corp., NY, pp 1152-1155.

Price and Parker

Price, W. A., and Parker, R. H. 1979. "Origins of Permanent Inlets Separating Barrier Islands and Influence of Drowned Valleys on Tidal Records Along the Gulf Coast of Texas," *Transactions Gulf Coast Association of Geological Societies*, Vol 29, pp 371-385.

Prins 1980

Prins, D. A. 1980. "Data Collection Methods for Sand Inventory-Type Surveys," Coastal Engineering Technical Aid No. 80-4, Coastal Engineering Research Center, U.S. Army Engineer Waterways Experiment Station, Vicksburg, MS.

Prior and Coleman 1979

Prior, D. B., and Coleman, J. M. 1979. "Submarine Landslides - Geometry and Nomenclature," *Zeitschrift für Geomorphology*, Vol 23, No. 4, pp 415-426.

Prior and Coleman 1980

Prior, D. B., and Coleman, J. M. 1980. "Sonograph Mosaics of Submarine Slope Instabilities, Mississippi River Delta," *Marine Geology*, Vol 36, pp 227-239.

Pritchard 1967

Pritchard, D. W. 1967. "What is an Estuary? Physical Viewpoint," *Estuaries*, Publication 83, G. H. Lauff, ed., American Association for the Advancement of Science, Washington, DC, pp 3-5.

Reading 1986

Reading, H. G., ed. 1986. *Sedimentary Environments and Facies*, 2nd ed., Blackwell Scientific Publications, Oxford, UK.

Reineck and Singh 1980

Reineck, H. E., and Singh, I. B. 1980. *Depositional Sedimentary Environments*, 2nd ed., Springer-Verlag, Berlin, Germany.

Resio and Hands 1994

Resio, D. T., and Hands, E. B. 1994. "Understanding and Interpreting Seabed Drifter (SBD) Data," Technical Report DRP-94-1, U.S. Army Engineer Waterways Experiment Station, Vicksburg, MS.

Richards 1986

Richards, V. A. 1986. *Remote Sensing Digital Image Analysis, An Introduction*, Springer Verlag, Berlin, Germany.

Roberts 1981

Roberts, H. H. 1981. "X-ray Radiography," *Geomorphological Techniques*, A. Goudie, ed., George Allen and Unwin, London, UK, pp 101-102.

Rosen, Brenninkmeyer, and Maybury 1993

Rosen, P. S., Brenninkmeyer, B. M., and Maybury, L. M. 1993. "Holocene Evolution of Boston Inner Harbor, Massachusetts," *Journal of Coastal Research*, Vol 9, No. 2, pp 363-377.

Sabins 1987

Sabins, F. F., Jr. 1987. *Remote Sensing, Principles and Interpretation*, 2nd ed., W. H. Freeman and Company, New York, NY.

Sahagian and Holland 1991

Sahagian, D. L., and Holland, S. M. 1991. Eustatic Sea-Level Curve Based on a Stable Frame of Reference: Preliminary Results, *Geology*, Vol 19, pp 1208-1212.

Sallenger, Holman, and Birkemeier 1985

Sallenger, A. H., Jr., Holman, R. A., and Birkemeier, W. A. 1985. "Storm-Induced Response of a Nearshore Bar System," *Marine Geology*, Vol 64, pp 237-257.

Sarna-Wojcicki, Champion, and Davis 1983

Sarna-Wojcicki, A. M., Champion, D. E., and Davis, J. O. 1983. "Holocene Volcanism in the Coterminous United States and the Role of Silicic Volcanic Ash Layers in Correlation of the Latest Pleistocene and Holocene Deposits," *Late Quaternary Environments of the United States: The Holocene*, H. E. Wright, ed., Vol 2, University of Minnesota Press, Minneapolis, MN, pp 52-77.

Savage and Birkemeier 1987

Savage, R. J., and Birkemeier, W. A. 1987. "Storm Erosion Data from the United States Atlantic Coast," *Coastal Sediments '87*, American Society of Civil Engineers, New York, NY, pp 1445-1459.

Saville 1957

Saville, T., Jr. 1957. "Scale Effects in Two-Dimensional Beach Studies," *Proceedings of the Seventh General Meeting of the International Association of Hydraulic Research*, pp A3.1-A3.8.

Saville and Caldwell 1953

Saville, T., Jr., and Caldwell, J. M. 1953. "Accuracy of Hydrographic Surveying in and Near the Surf Zone," Technical Memorandum No. 32, Beach and Erosion Board, Corps of Engineers, Department of the Army, Washington, DC.

Schneider 1981

Schneider, C. 1981. "The Littoral Environment Observation (LEO) Data Collection Program," Coastal Engineering Research Center Technical Aid 81-5, U.S. Army Engineer Waterways Experiment Station, Vicksburg, MS.

Schwartz 1971

Schwartz, M. L. 1971. "The Multiple Casualty of Barrier Islands," *Journal of Geology*, Vol 79, pp 91-94.

Schwartz 1973

Schwartz, M. L., ed. 1973. *Barrier Islands*, Dowden, Hutchinson & Ross, Stroudsburg, PA.

Schwartz 1982

Schwartz, M. L., ed. 1982. *The Encyclopedia of Beaches and Coastal Environments*, Encyclopedia of Earth Sciences, Volume XV, Hutchinson Ross Publishing Company, Stroudsburg, PA.

Seabergh and McCoy 1982

Seabergh, W. C., and McCoy, J. W. 1982. "Prevention of Shoaling at Little Lake Harbor, Michigan," Technical Report HL-82-16, U.S. Army Engineer Waterways Experiment Station, Vicksburg, MS.

Seelig, Harris, and Herchenroder 1977

Seelig, W. N., Harris, D. L., and Herchenroder, B. E. 1977. "A Spatially Integrated Numerical Model of Inlet Hydraulics," General Investigation of Tidal Inlets Report 14, U.S. Army Engineer Waterways Experiment Station, Vicksburg, MS.

Seymour 1989

Seymour, R. J., ed. 1989. *Nearshore Sediment Transport*. Plenum Press, New York, NY.

Sha 1990

Sha, L. P. 1990. *Sedimentological Studies of the Ebb-tidal Deltas Along the West Frisian Islands, the Netherlands*, Geologica Ultraiectina No. 64, Instituut voor Aardwetenschappen der Rijks-universiteit te Utrecht, Utrecht, The Netherlands (in English).

Shalowitz 1962

Shalowitz, A. L. 1962. *Shore and Sea Boundaries*, Vol 1, Pub 10-1, U.S. Department of Commerce, Coast and Geodetic Survey, U.S. Government Printing Office, Washington, DC.

Shalowitz 1964

Shalowitz, A. L. 1964. *Shore and Sea Boundaries*, Vol 2, Pub 10-1, U.S. Department of Commerce, Coast and Geodetic Survey, U.S. Government Printing Office, Washington, DC.

Shepard 1932

Shepard, F. P. 1932. "Sediments on Continental Shelves," *Geological Society of America Bulletin*, Vol 43, pp 1017-1034.

Shepard 1937

Shepard, F. P. 1937. "Revised Classification of Marine Shorelines," *Journal of Geology*, Vol 45, pp 602-624.

Shepard 1948

Shepard, F. P. 1948. *Submarine Geology*, Harper & Row, New York, NY.

Shepard 1950

Shepard, F. P. 1950. "Longshore Bars and Longshore Troughs," Technical Memorandum 41, Beach Erosion Board, U.S. Army Corps of Engineers, Washington, DC.

Shepard 1963

Shepard, F. P. 1963. *Submarine Geology*, 2nd ed., Harper & Row, New York, NY.

Shepard 1973

Shepard, F. P. 1973. *Submarine Geology*, 3rd ed., Harper & Row, New York, NY.

Shepard 1976

Shepard, F. P. 1976. "Coastal Classification and Changing Coastlines," *Geoscience and Man*, Vol 13, pp 53-64.

Shepard 1977

Shepard, F. P. 1977. *Geological Oceanography*, Crane, Russak & Co., New York, NY.

Shepard and Inman 1950

Shepard, F. P., and Inman, D. L. 1950. "Nearshore Circulation Related to Bottom Topography and Wave Refraction," *Transactions of the American Geophysical Union*, Vol 31, No. 4, pp 555-556.

Shepard and LaFond 1940

Shepard, F. P., and LaFond, E. C. 1940. "Sand Movements at the Beach in Relation to Tides and Waves," *American Journal of Science*, Vol 238, pp 272-285.

Shepard and Wanless 1971

Shepard, F. P., and Wanless, H. R. 1971. *Our Changing Coastlines*, McGraw-Hill Book Company, New York, NY.

Sheriff 1980

Sheriff, R. E. 1980. *Seismic Stratigraphy*, International Human Resources Development Corporation, Boston, MA.

Sheriff and Geldart 1982

Sheriff, R. E., and Geldart, L. P. 1982. *Exploration Seismology, Vol 1: History, Theory, and Data Acquisition*, Cambridge University Press, Cambridge, UK.

Sherlock and Szuwalski 1987

Sherlock, A. R., and Szuwalski, A. 1987. "A Users Guide to the Littoral Environment Observation Retrieval System," Instruction Report CERC-87-3, U.S. Army Engineer Waterways Experiment Station, Vicksburg, MS.

Shore Protection Manual 1984

Shore Protection Manual. 1984. 4th ed., 2 Vol, Coastal Engineering Research Center, U.S. Army Engineer Waterways Experiment Station, U.S. Government Printing Office, Washington, DC.

Short 1991

Short, A. D. 1991. "Macro-meso Tidal Beach Morphodynamics - An Overview," *Journal of Coastal Research*, Vol 7, No. 2, pp 417-436.

Sieck and Self 1977

Sieck, H. C., and Self, G. W. 1977. "Analysis of High Resolution Seismic Data," *Seismic Stratigraphy - Applications to Hydrocarbon Exploration*, C. E. Payton, ed., American Association of Petroleum Geologists, Tulsa, OK, pp 353-385.

Siegal and Gillespie 1980

Siegal, B. S., and Gillespie, A. R., eds. 1980. *Remote Sensing in Geology*, John Wiley & Sons, New York, NY.

Simpson and Riehl 1981

Simpson, R. H., and Riehl, H. 1981. *The Hurricane and its Impact*, Louisiana State University Press, Baton Rouge, LA.

Smith 1954

Smith, H. T. U. 1954. "Coastal Dunes," *Proceedings of the Coastal Geography Conference*, Office of Naval Research, Department of the Navy, Washington, DC, pp 51-56.

Sommerfeld, Mason, Kraus, and Larson 1994

Sommerfeld, B. G., Mason, J. M., Kraus, N. C., and Larson, M. 1994. "BFM: Beach Fill Module; Report 1, Beach Morphology Analysis Package (BMAP) - User's Guide," Instruction Report CERC-94-1, U.S. Army Engineer Waterways Experiment Station, Vicksburg, MS.

Sonu 1970

Sonu, C. J. 1970. "Beach Changes by Extraordinary Waves Caused by Hurricane Camille," Coastal Studies Institute, Technical Report 77, Louisiana State University, Baton Rouge, LA, pp 33-45.

Sonu and Wright 1975

Sonu, C. J., and Wright, L. D. 1975. "Mass Transport and Dispersion Off a Tidal Inlet," Seventh Annual Off-shore Technology Conference, Houston, TX, Paper OTC 2383, pp 489-498.

Spain 1990

Spain, P. 1990. "Observing Depth-Averaged and Superficial Currents Across the North Pacific," *Proceedings of the IEEE Fourth Working Conference on Current Measurement*, G. F. Appell and T. B. Curtin, eds., Current Measurement Technology Committee of the Oceanic Engineering Society, Institute of Electrical and Electronics Engineers, New York, NY, pp 54-64.

Spangler and Hardy 1982

Spangler, M. G., and Hardy, R. L. 1982. *Soil Engineering*, 4th ed., Harper & Row, New York, NY.

Spurgeon 1992

Spurgeon, J. P. G. 1992. "The Economic Valuation of Coral Reefs," *Marine Pollution Bulletin*, Vol 24, No. II, pp 529-536.

Stahl, Koczan, and Swift 1974

Stahl, L., Koczan, J., and Swift, D. J. P. 1974. "Anatomy of a Shoreface-Connected Ridge System on the New Jersey Shelf: Implications for Genesis of the Shelf Surficial Sand Sheet," *Geology*, Vol 2, pp 117-120.

Stanley 1986

Stanley, S. M. 1986. *Earth and Life Through Time*, W. H. Freeman, New York, NY.

Stauble 1992

Stauble, D. K. 1992. "Long-term Profile and Sediment Morphodynamics: Field Research Facility Case History," Technical Report CERC-92-7, U.S. Army Engineer Waterways Experiment Station, Vicksburg, MS.

Stauble 1994

Stauble, D. K. 1994. "A Physical Monitoring Plan for Northern Assateague Island, Maryland," U.S. Department of Interior, National Park Service, Philadelphia, PA.

Stauble and Hoel 1986

Stauble, D. K. and Hoel, J. 1986. "Guidelines for Beach Restoration Projects, Part II-Engineering." Report SGR-77, Florida Sea Grant, University of Florida, Gainesville, FL.

Stauble and Kraus 1993

Stauble, D. K., and Kraus, N. C. 1993. *Beach Nourishment Engineering and Management Considerations*, Coastlines of the World series, American Society of Civil Engineers, New York, NY.

Stauble, Da Costa, Monroe, and Bhogal 1988

Stauble, D. K., Da Costa, S. L., Monroe, K. L., and Bhogal, V. K. 1988. "Inlet Flood Tidal Delta Development Through Sediment Transport Processes," *Hydrodynamics and Sediment Dynamics of Tidal Inlets*, Lecture Notes on Coastal and Estuarine Studies, D. G. Aubry and L. Weishar, eds., Vol 29, Springer-Verlag, New York, NY, pp 319-347.

Stauble, Garcia, Kraus, Grosskopf, and Bass 1993

Stauble, D. K., Garcia, A. W., Kraus, N. C., Grosskopf, W. G., and Bass, G. P. 1993. "Beach Nourishment Project Response and Design Evaluation, Ocean City, Maryland," Technical Report CERC-93-13, U.S. Army Engineer Waterways Experiment Station, Vicksburg, MS.

Sternberg 1989

Sternberg, R. W. 1989. "Instrumentation for Estuarine Research," *Journal of Geophysical Research*, Vol 94, No. C10, pp 14,289-14,301.

Stewart 1985

Stewart, R. H. 1985. *Methods of Satellite Oceanography*, University of California Press, Berkeley, CA.

Stewart and Pope 1992

Stewart, C. J., and Pope, J. 1992. "Erosion Processes Task Group Report," Open file report prepared for the International Joint Commission Water Level Reference

Study, International Joint Commission, Canada and U.S.A.

Stoddard 1969

Stoddard, D. R. 1969. "Ecology and Morphology of Recent Coral Reefs," *Biological Reviews*, Vol 44, pp 433-498.

Stone and Morgan 1993

Stone, G. W., and Morgan, J. P. 1993. "Implications for a Constant Rate of Relative Sea-Level Rise During the Last Millennium Along the Northern Gulf of Mexico: Santa Rosa Island, Florida," *Shore and Beach*, Vol 61, No. 4, pp 24-27.

Strahler 1971

Strahler, A. N. 1971. *The Earth Sciences*, 2nd ed., Harper & Row Publishers, New York, NY.

Strahler 1981

Strahler, A. N. 1981. *Physical Geology*, Harper & Row, New York, NY.

Stubblefield, Lavelle, McKinney, and Swift 1974

Stubblefield, W. L., Lavelle, J. W., McKinney, T. F., and Swift, D. J. P. 1974. "Sediment Response to the Present Hydraulic Regime on the Central New Jersey Shelf," *Journal of Sedimentary Petrology*, Vol 45, pp 337-358.

Suess 1888

Suess, E. 1888. *The Faces of the Earth*, Vol 2 (English translation by H. B. Sollas in 1906), Oxford University Press, London, UK (in 5 vols).

Suhayda 1984

Suhayda, J. N. 1984. "Interaction Between Surface Waves and Muddy Bottom Sediments," *Estuarine Cohesive Sediment Dynamics*, Lecture Notes on Coastal and Estuarine Studies, A. J. Mehta, ed., Springer-Verlag, Berlin, pp 401-428.

Sunamura 1976

Sunamura, T. 1976. "Feedback Relationship in Wave Erosion of Laboratory Rocky Coast," *Journal of Geology*, Vol 84, pp 427-437.

Sunamura 1983

Sunamura, T. 1983. "Processes of Sea Cliff and Platform Erosion," *CRC Handbook of Coastal Processes and Erosion*, P. D. Komar, ed., CRC Press, Boca Raton, FL, pp 233-266.

Sunamura 1989

Sunamura, T. 1989. "Sandy Beach Morphology Elucidated by Laboratory Modeling," *Applications in Coastal Modeling*, V. C. Lakhan and A. S. Trenhale, eds., Elsevier, New York, pp 159-213.

Sunamura and Maruyama 1987

Sunamura, T., and Maruyama, K. 1987. "Wave-Induced Geomorphic Response of Eroding Beaches - With Special Reference to Seaward Migrating Bars," *Proceedings of Coastal Sediments '87*, American Society of Civil Engineers, New York, NY, pp 788-801.

Suter and Berryhill 1985

Suter, J. R., and Berryhill, H. L., Jr. 1985. "Late Quaternary Shelf-Margin Deltas, Northwest Gulf of Mexico," *Bulletin of the American Association of Petroleum Geologists*, Vol 69, No. 1, pp 77-91.

Swift 1975

Swift, D. J. P. 1975. "Tidal Sand Ridges and Shoal Retreat Massifs," *Marine Geology*, Vol 18, pp 105-134.

Swift 1976

Swift, D. J. P. 1976. "Coastal Sedimentation," *Marine Sediment Transport and Environmental Management*, D. J. Stanley and D. J. P. Swift, eds., John Wiley and Sons, New York, NY, pp 255-310.

Swift, Kofoed, Saulsbury, and Sears 1972

Swift, D. J. P., Kofoed, J. W., Saulsbury, F. P., and Sears, P. 1972. "Holocene Evolution of the Shelf Surface, Central and Southern Atlantic Coast of North America," *Shelf Sediment Transport*, D. J. P. Swift, D. B. Duane, and O. H. Pilkey, eds., Dowd, Hutchinson, and Ross, Stroudsburg, PA, pp 499-574.

Tait 1993

Tait, L. S., Compiler. 1993. *The State of the Art of Beach Renourishment*, *Proceedings of the 6th Annual National Conference on Beach Preservation Technology*, Florida Shore & Beach Preservation Association, Tallahassee, FL.

Tang and Dalrymple 1989

Tang, E. C. S., and Dalrymple, R. A. 1989. "Nearshore Circulation by Rip Currents and Wave Groups," *Near-shore Sediment Transport*, R. J. Seymour, ed., Plenum Press, New York, NY, pp 205-230.

Tannehill 1956

Tannehill, I. R. 1956. *Hurricanes, Their Nature and History*, 9th Revised ed., Princeton University Press, Princeton, NJ.

Tanner 1967

Tanner, W. F. 1967. "Ripple Mark Indices and Their Uses," *Sedimentology*, Vol 9, pp 89-104.

Tanner 1978

Tanner, W. F., ed. 1978. "Standards for Measuring Shoreline Change," *Coastal Research*, Tallahassee, FL.

Tanner 1989

Tanner, W. F. 1989. "New Light on Mean Sea Level Change," *Coastal Research*, Vol 8, No. 4, pp 12-16.

Tchernia 1980

Tchernia, P. 1980. *Descriptive Regional Oceanography*, Pergamon Press, Oxford, UK.

Teleki 1966

Teleki, P. G. 1966. "Fluorescent Sand Tracers," *Journal of Sedimentary Petrology*, Vol 36, pp 376-468.

Teleki, Musialowski, and Prins 1976

Teleki, P. G., Musialowski, F. R. and Prins, D. A. 1976. "Measurement Techniques for Coastal Waves and Currents," Information Report 76-11, Coastal Engineering Research Center, U.S. Army Engineer Waterways Experiment Station, Vicksburg, MS.

The Times Atlas of the World 1980

The Times Atlas of the World. 1980. Comprehensive Edition, Times Books, NY.

Thompson, Howell, and Smith 1985

Thompson, E. F., Howell, G. L., and Smith, J. M. 1985. "Evaluation of Seismometer Wave Gage and Comparative Analysis of Wave Data at Yaquina and Coquille Bays, Oregon," Miscellaneous Paper CERC-85-12, U.S. Army Engineer Waterways Experiment Station, Vicksburg, MS.

Tilling, Heliker, and Wright 1987

Tilling, R. I., Heliker, C., and Wright, T. L. 1987. "Eruptions of Hawaiian Volcanoes: Past, Present, and Future," U.S. Geological Survey, Denver, CO.

Trenhaile 1987

Trenhaile, A. S. 1987. *The Geomorphology of Rock Coasts*, Clarendon Press, Oxford, UK.

Trewartha 1954

Trewartha, G. T. 1954. *An Introduction to Climate*, McGraw-Hill Book Co., New York, NY.

Trimble and Cooke 1991

Trimble, S. W., and Cooke, R. U. 1991. "Historical Sources for Geomorphology Research in the United States," *The Professional Geographer*, Vol 43, pp 212-227.

Trudgill 1976

Trudgill, S. T. 1976. "The Marine Erosion of Limestone on Aldabra Atoll, Indian Ocean," *Zeitschrift für geomorphology*, Vol 26, pp 164-200.

Trump 1990

Trump, C. L. 1990. "Single Ping ADCP Data," *Proceedings of the IEEE Fourth Working Conference on Current Measurement*, Current Measurement Technology Committee of the Oceanic Engineering Society, G. F. Appell and T. B. Curtin, eds., Institute of Electrical and Electronics Engineers, New York, NY, pp 215-224.

Uchupi 1968

Uchupi, E. 1968. "Atlantic Continental Shelf and Slope of the United States-Physiography," Professional paper 529-C, United States Geological Survey, Washington, DC.

Uchupi 1970

Uchupi, E. 1970. "Atlantic Continental Shelf and Slope of the United States: Shallow Structure," Professional paper 524-1, United States Geological Survey, Washington, DC, pp 1-44.

Unluata and Ozsoy 1977

Unluata, U. A., and Ozsoy, E. 1977. "Tidal Jet Flows Near Inlets," *Hydraulics in the Coastal Zone*, American Society of Civil Engineers, New York, NY, pp 90-98.

U.S. Army Engineer District, Jacksonville 1993

U.S. Army Engineer District, Jacksonville. 1993. "Nassau County, Florida, Fernandina Harbor, Section 933 Study," Jacksonville, FL.

U.S. Army Engineer Waterways Experiment Station 1992

U.S. Army Engineer Waterways Experiment Station. 1992. "The Wetlands Research Program Notebook," Technical Notes, USAE Waterways Experiment Station, Vicksburg, MS.

U.S. Coast and Geodetic Survey 1985

U.S. Coast and Geodetic Survey. 1985. "Datum Differences - Atlantic, Gulf, and Pacific Coasts, United States," Washington, DC.

Vachon 1980

Vachon, W. A. 1980. "Drifters," *Air-Sea Interaction-Instruments and Methods*, Plenum Press, New York, NY, pp 201-218.

Valentin 1952

Valentin, H. 1952. *Die Kusten der Erde*, Petermanns Geog. Mitt. Erg. 246, Justus Perthes Gotha, Berlin, Germany.

Van de Kreeke 1986

Van de Kreeke, J., ed. 1986. *Physics of Shallow Estuaries and Bays*, Lecture Notes on Coastal and Estuarine Studies, Vol 16, Springer-Verlag, New York, NY.

Vanoni 1975

Vanoni, V. A., ed. 1975. *Sedimentation Engineering*, Manuals and Reports on Engineering Practice No. 54, American Society of Civil Engineers, New York, NY.

van Straaten 1961

van Straaten, L. M. J. U. 1961. "Directional Effects of Winds, Waves, and Currents Along the Dutch Coast North Sea Coast," *Geologie en Mijnbouw*, Vol 40, pp 333-346 and 363-391.

Veatch and Smith 1939

Veatch, A. C., and Smith, P. A. 1939. "Atlantic Submarine Valleys of the United States and the Congo Submarine Valley," *Special Paper 7, The Geological Society of America*, New York, NY.

von Arx 1962

von Arx, W. S. 1962. *An Introduction to Physical Oceanography*, Addison-Wesley Publishing Company, Reading, MA.

Waisel 1972

Waisel, Y. 1972. *Biology of Halophytes*, Academic Press, NY.

Walton 1990

Walton, T. L., Jr. 1990. "Simulating Great Lakes Water Levels for Erosion Prediction," Miscellaneous Paper CERC-90-6, U.S. Army Engineer Waterways Experiment Station, Vicksburg, MS.

Walton and Adams 1976

Walton, T. L., Jr., and Adams, W. D. 1976. "Capacity of Inlet Outer Bars to Store Sand," *Proceedings of the Fifteenth Coastal Engineering Conference*, July 11-17, Honolulu, HI, American Society of Civil Engineers, New York, NY, pp 1919-1937.

Weaver 1983

Weaver, H. J. 1983. *Applications of Discrete and Continuous Fourier Analysis*. John Wiley & Sons, New York, NY.

Wells and Coleman 1981

Wells, J. T., and Coleman, J. M. 1981. "Periodic Mudflat Progradation, Northeastern Coast of South America: A Hypothesis," *Journal of Sedimentary Petrology*, Vol 51, No. 4, pp 1069-1075.

Wilde and Case 1977

Wilde, P., and Case, C. W. 1977. "Technique for Predicting Sediment Transport in the Marine Environment Using Natural Heavy Mineral Tracers," *Shore and Beach*, Vol 45, No. 2, pp 25-29.

Williams 1976

Williams, S. J. 1976. "Geomorphology, Shallow Sub-bottom Structure, and Sediments of the Atlantic Inner Continental Shelf Off Long Island, New York," Technical Paper No. 76-2, Coastal Engineering Research Center, U.S. Army Engineer Waterways Experiment Station, Vicksburg, MS.

Williams 1981

Williams, S. J. 1981. "Sand Resources and Geological Character of Long Island Sound," Technical Paper No. 81-3, Coastal Engineering Research Center, U.S. Army Engineer Waterways Experiment Station, Vicksburg, MS.

Williams and Duane 1974

Williams, S. J., and Duane, D. B. 1974. "Geomorphology and Sediments of the Inner New York Bight Continental Shelf," Technical Memorandum No. 45, Coastal Engineering Research Center, U.S. Army Engineer Waterways Experiment Station, Vicksburg, MS.

Williams and Meisburger 1982

Williams, S. J., and Meisburger, E. P. 1982. "Geological Character and Mineral Resources of South Central Lake Erie," Miscellaneous Report No. 82-9, Coastal Engineering Research Center, USAE Waterways Experiment Station, Vicksburg, MS.

Williams, Carter, Meisburger, and Fuller 1980

Williams, S. J., Carter, C. H., Meisburger, E. P., and Fuller, J. A. 1980. "Sand Resources of Southern Lake Erie, Conneaut to Toledo, Ohio - a Seismic Reflection and Vibracore Study," Miscellaneous Report No. 80-10, Coastal Engineering Research Center, U.S. Army Engineer Waterways Experiment Station, Vicksburg, MS.

Williams, Prins, and Meisburger 1979

Williams, S. J., Prins, D. A., and Meisburger, E. P. 1979. "Sediment Distribution Sand Resources, and Geologic Character of the Inner Continental Shelf Off Galveston County Texas," Miscellaneous Report No. 79-4, Coastal Engineering Research Center, U.S. Army Engineer Waterways Experiment Station, Vicksburg, MS.

Winkler 1977

Winkler, C. D. 1977. "Plio-Pleistocene Paleogeography of the Florida Gulf Coast Interpreted from Relic Shorelines," *Transactions Gulf Coast Association of Geological Societies*, Vol 27, pp 409-420.

Winkler and Howard 1977

Winkler, C. D., and Howard, J. D. 1977. "Correlation of Tectonically-Deformed Shorelines on the Southern Atlantic Coastal Plain," *Geology*, Vol 5, pp 123-127.

Wise 1980

Wise, S. M. 1980. "Caesium-137 and Lead-210: A Review of the Techniques and Some Applications in Geomorphology," *Timescales in Geomorphology*, R. A. Cullingford, D. A. Davidson, and J. Lewin, eds., John Wiley, Chichester, UK, pp 107-127.

Wood and Kienle 1990

Wood, C. A., and Kienle, J., eds. 1990. *Volcanoes of North America: United States and Canada*, Cambridge University Press, Cambridge, UK.

Woodhouse 1978

Woodhouse, W. W., Jr. 1978. "Dune Building and Stabilization with Vegetation," SR-3, Coastal Engineering Research Center, U.S. Army Engineer Waterways Experiment Station, Vicksburg, MS.

Woodsworth and Wigglesworth 1934

Woodsworth, J. B., and Wigglesworth, E. 1934. *Geography and Geology of the Region Including Cape Cod, Elizabeth Is., Nantucket, Martha's Vinyard, No Mans Land, and Block Is.*, Memoir 52, Museum of Comparative Zoology, Harvard University, Cambridge, MA.

Worsley 1981

Worsley, P. 1981. "Lichenometry," *Geomorphological Techniques*, A. Goudie, ed., George Allen and Unwin, London, UK, pp 302-305.

Wright 1981

Wright, L. D. 1981. "Nearshore Tidal Currents and Sand Transport in a Macrotidal Environment," *Geomarine Letters*, Vol 1, pp 173-179.

Wright 1985

Wright, L. D. 1985. "River Deltas," *Coastal Sedimentary Environments*, 2nd ed., R. A. Davis, ed., Springer-Verlag, New York, NY, pp 1-76.

Wright 1991

Wright, L. D., Boon, J. D., Kim, S. C., and List, J. H. 1991. "Modes of Cross-Shore Sediment Transport on the Shoreface of the Middle Atlantic Bight," *Marine Geology*, Vol 96, pp 19-51.

Wright and Coleman 1972

Wright, L. D., and Coleman, J. M. 1972. "River Delta Morphology: Wave Climate and the Role of the Subaqueous Profile," *Science*, Vol 176, pp 282-284.

Wright and Coleman 1973

Wright, L. D., and Coleman, J. M. 1973. "Variations in Morphology of Major River Deltas as Functions of Ocean Wave and River Discharge Regimes," *American Association of Petroleum Geologists Bulletin*, Vol 57, No. 2, pp 370-398.

Wright and Coleman 1975

Wright, L. D., and Colman, J. M. 1975. "Mississippi River Mouth Processes: Effluent Dynamics and Morphologic Development," *Journal of Geology*, Vol 82, pp 751-778.

Wright and Short 1983

Wright, L. D., and Short, A. D. 1983. "Morphodynamics of Beaches and Surf Zones in Australia," *Handbook of Coastal Processes and Erosion*, P. D. Komar, ed., CRC Press, Boca Raton, FL, pp 35-64.

Wright and Short 1984

Wright, L. D., and Short, A. D. 1984. "Morphodynamic Variability of Surf Zones and Beaches: A Synthesis," *Marine Geology*, Vol 56, pp 93-118.

Wright and Sonu 1975

Wright, L. D., and Sonu, C. J. 1975. "Processes of Sediment Transport and Tidal Delta Development in a Stratified Tidal Inlet," *Estuarine Research*, Vol 2, L. E. Cronin, ed., Academic Press, New York, NY, pp 63-76.

Wright, Boon, Kim, and List 1991

Wright, L. D., Boon, J. D., Kim, S. C., and List, J. H. 1991. "Modes of Cross-Shore Sediment Transport on the Shoreface of the Middle Atlantic Bight," *Marine Geology*, Vol 96, pp 19-51.

Wright, Sonu, and Kielhorn 1972

Wright, L. D., Sonu, C. J., and Kielhorn, W. V. 1972. "Water-Mass Stratification and Bed Form Characteristics in East Pass, Destin, Florida," *Marine Geology*, Vol 12, pp 43-58.

Wright, Xu, and Madsen 1994

Wright, L. D., Xu, J. P., and Madsen, O. S. 1994. "Across-shelf Benthic Transports on the Inner Shelf of the Middle Atlantic Bight During the 'Halloween Storm' of 1991," *Marine Geology*, Vol 118, No. 1/2, pp 61-77.

Wunsch 1978

Wunsch, C. 1978. "The North Atlantic General Circulation West of 50 deg W Determined by Inverse Methods," *Reviews of Geophysics and Space Physics*, Vol 16, No. 4, pp 583-620.

Wunsch and Minster 1982

Wunsch, C., and Minster, J. F. 1982. "Methods for Box Models and Ocean Circulation Tracers: Mathematical Programming and Nonlinear Inverse Theory," *Journal of Geophysical Research*, Vol 87, pp 5647-5662.

Young 1975

Young, K. 1975. *Geology: The Paradox of Earth and Man*, Houghton Mifflin Co., Boston, MA.

Zenkovich 1967

Zenkovich, V. P. 1967. "Submarine Sandbars and Related Formations," *Processes of Coastal Development*, J. A. Steers, ed., Oliver and Boyd, Ltd., New York, NY, pp 219-236.

Appendix B Glossary¹

ANOXIC Refers to ocean basins that contain little or no dissolved oxygen and hence little or no benthic marine life. These conditions arise in basins or fjords where physical circulation of seawater is limited.

ANTIDUNES Bed forms that are in phase with water surface gravity waves. Height and wavelength depend on the scale of the system and characteristics of the fluid and bed material (Figure 4-3).

BACK BARRIER Pertaining to the lagoon-marsh-tidal creek complex in the lee of a coastal barrier island, barrier spit, or baymouth barrier (Figures 3-15 and 3-16).

BACKSHORE The portion of a beach that extends from the upward limit of wave uprush at normal high tide landward to the first major change in topography (such as the base of a cliff or dune). Backshore is the horizontal upper part of a beach and is approximately synonymous to berm (Figure 2-1).

BARRIERS, COASTAL Elongated, shore-parallel, usually sandy features that parallel coasts in many places and are separated from the mainland by bodies of water of various sizes, and/or salt marshes, lagoons, mud, or sand flats, and tidal creeks (Figures 3-15 and 3-16).

BED FORMS Deviations from a flat bed generated by stream flow on the bed of an alluvial channel.

BEDROCK The solid rock that underlies gravel, soil, and other superficial material. Bedrock may be exposed at the surface (an outcrop) or it may be buried under hundreds or thousands of meters of unconsolidated material (as along the Gulf of Mexico coast).

BIOTURBATION The disturbance of sediment bedding by the activities of burrowing organisms.

BOTTOMSET (bed) One of the horizontal or gently inclined sediment layers deposited in front of the advancing foreset beds of a delta.

CHEMICAL WEATHERING Disintegration of rocks and sediments by chemical alteration of the constituent

minerals or of the cementing matrix. It is caused by exposure, oxidation, temperature changes, and biological processes.

CLIMATE Characterization of the prevailing, long-term meteorologic conditions of an area using averages and various statistics.

CLOSURE DEPTH The depth beyond which sediments are not normally affected by waves.

COAST A strip of land of indefinite width that extends from the coastline inland as far as the first major change in topography (such as the base of a cliff or dune).

COASTAL PLAIN A relatively low plain of subdued topography underlain by horizontal or gently sloping sedimentary strata extending inland of a coastline (Figure 2-2).

COASTAL ZONE The transition zone where the land meets water, the region that is directly influenced by marine and lacustrine hydrodynamic processes. Extends offshore to the continental shelf break and onshore to the first major change in topography above the reach of major storm waves. On barrier coasts, includes the bays and lagoons between the barrier and the mainland.

CONSOLIDATION The adjustment and compaction of sediment in response to increased load (e.g. the squeezing of water from the pores).

CONTINENTAL SHELF The submerged zone bordering a coast from the toe of the shoreface to the depth where there is a marked steepening of slope (Figure 2-2).

CORAL REEF Massive (usually) calcareous rock structure that is slowly constructed by simple colonial animals that live as a thin layer on the rock surface. The living organisms continually build new structures on top of the old, extending the reef seaward and upward towards the surface (Figure 3-23).

CYCLONE A system of winds that rotates about a center of low atmospheric pressure. Rotation is clockwise in the Southern Hemisphere and anti-clockwise in the Northern Hemisphere.

DATUM A fixed or assumed line, point, or surface in relation to which others are determined (example: datum plane of mean sea level) (Tables 2-2 and 2-3).

¹ An extensive glossary of cartographic terms is provided in Appendix A of Shalowitz (1964).

DELTAIC Pertaining to river deltas (Figure 4-9).

DENDROCHRONOLOGY The examination and correlation of growth rings of trees with the purpose of dating events in the recent past.

DOWNDRIFT The direction in which littoral drift is moving.

DUNE Underwater: Flow-transverse bedform with spacing from under 1 m to over 1,000 m that develops on a sediment bed under unidirectional currents (Figure 4-3). On land: A rounded hill or ridge of sand heaped up by action of the wind (Figure 3-7).

EBB SHIELD High, landward margin of a flood-tidal shoal that helps divert ebb-tide currents around the shoal (Figure 4-15).

EL NIÑO Warm equatorial water which flows southward along the coast of Peru during February and March of certain years. It is caused by poleward motions of air, which cause coastal downwelling, leading to the reversal in the normal north-flowing cold coastal currents. El Niño can cause a great reduction in fisheries and severe economic hardships.

ESTUARY The seaward portion of a drowned valley that receives sediment from both fluvial and marine sources, and that contains sedimentary facies influenced by tide, wave, and fluvial processes (Figure 3-1). Fresh water mixes with seawater in estuaries, resulting in complex biological and chemical environments.

EUSTATIC SEA LEVEL CHANGE Change in the relative volume of the world's ocean basins and the total amount of ocean water. It must be measured by recording the movement in sea surface elevation relative to a stable, undeformed, universally adopted reference frame.

EXFOLIATION A type of jointing which occurs in concentric shells around a rock mass - caused by the release of confining pressure.

FLUVIAL Pertaining to streams; e.g. fluvial sediments.

FLOOD CHANNEL Channel located on ebb-tidal shoal that carries the flood tide over the tidal flat into the back bay or lagoon (Figure 4-15).

FLOOD RAMP Seaward-dipping sand platform dominated by flood-tidal currents, located on ebb-tidal shoal near the opening to the inlet (Figure 4-15).

FORESET (bed) Inclined layers of a cross-bedded unit, specifically on the frontal slope of a delta or the lee of a dune.

FORESHORE The beach face, the portion of the shore extending from the low-water line up to the limit of wave uprush at high tide (Figure 2-1).

GEOCHRONOLOGY The study of time in relationship to the history of the earth. Encompasses radiometric and non-radiometric techniques to date sediments and strata (Figure 2-3).

HALF LIFE The time required for half of the atoms of a radioactive element to disintegrate into atoms of another element.

HEAVY MINERAL Mineral species with a specific gravity greater than a heavy liquid such as bromoform, used to separate heavies from lighter minerals. Usually with a specific gravity of around 2.9 or higher.

HOLOCENE An epoch of the Quaternary period from the end of the Pleistocene (approximately 8,000 years ago) to the present. Often used as a synonym for recent (Table 2-1).

HOMOPYCNAL FLOW A condition in which the outflow jet from a river or coastal inlet and the water in the receiving basin are of the same density or are vertically mixed.

HYPERPYCNAL FLOW Outflow from an inlet or saline lagoon where the issuing water is denser and plunges beneath the receiving basin water. Dense, saline water flowing out of the Mediterranean sea through the Straits of Gibraltar is hyperpycnal and forms a deep, characteristic plume in the Atlantic.

HYPOPYCNAL FLOW Outflow from a river or coastal inlet in which a wedge of less dense water flows over the denser sea water.

INLET A connecting passage between two bodies of water (Figure 4-15). Typically refers to tidal openings in barrier islands, but can also be applied to river mouths in tidal and non-tidal environments.

INTERTIDAL Between high and low water.

ISOSTATIC ADJUSTMENT The process by which the crust of the earth attains gravitational equilibrium with respect to superimposed forces such as gravity. An example is the depression of land masses caused by the overburden of continental glaciers.

JETTY A shore-perpendicular structure built to stabilize an inlet and prevent the inlet channel from filling with sediment.

JOINTING The tendency of rocks to develop parallel sets of fractures without obvious external movement like faulting.

LAGOON Open water between a coastal barrier and the mainland. Also water bodies behind coral reefs and enclosed by atolls (Figures 3-16 and 3-23).

LAHAR A landslide or mudflow of pyroclastic material that flows down the flanks of a volcano, often at great speed and with destructive violence.

LAMINAE (or lamina) The thinnest recognizable layer in a sediment or sedimentary rock.

LAVA Molten rock (and gasses with the rock) that have erupted onto the earth's surface.

LICHENOMETRY The study of lichens, complex thallophytic plants consisting of algae and fungus growing in symbiotic association, to determine relative ages of sedimentary structures.

LITHOLOGY The general character of a rock or sediment.

LITTORAL DRIFT The movement of sediment alongshore. Also the material being moved alongshore.

MAGMA Molten rock that is still underground.

MARGINAL FLOOD CHANNELS Channels flanking the updrift and downdrift barrier island shores which carry flood tidal currents into the mouth of an inlet (Figure 4-15).

MARSH A permanently or periodically submerged low-lying area that is vegetated.

MECHANICAL WEATHERING The physical breakdown of rocks and sediments by agents that cause abrasion (running water and waves), expansion and

contraction (temperature changes, hydration, freezing and thawing), and splitting (tree roots and boring organisms).

METEOROLOGY The study of the spatial and temporal behavior of atmospheric phenomena.

MUD FLAT A level area of fine silt and clay along a shore alternately covered or uncovered by the tide or covered by shallow water.

NATURAL TRACER A component of a sediment deposit that is unique to a particular source and can be used to identify the source and transport routes to a place of deposition.

NEARSHORE The region seaward of the shore (from approximately the step at the base of the surf zone) extending offshore to the toe of the shoreface (Figure 2-1). Nearshore is a general term used loosely by different authors to mean various areas of the coastal zone, ranging from the shoreline to the edge of the continental shelf.

OVERWASH A process in which waves penetrate inland of the beach. Particularly common on low barriers (Figure 2-1).

PALEOECOLOGY Study of the relationship between ancient organisms and their environment.

PALEOSOL A buried (possibly ancient) soil.

PALYNOLOGY The study of pollen and spores in ancient sediments.

PEAT Unconsolidated deposit of semicarbonized plant remains in a water-saturated environment such as a bog. Considered an early stage in the development of coal.

PEDOGENESIS Soil formation.

PITCH Angle between the horizontal and any linear feature.

PLANE BEDS A horizontal bed without elevations or depressions larger than the maximum size of the exposed sediment grains (Figure 4-3).

PLEISTOCENE An epoch of the Quaternary period before the Holocene. It began 2 to 3 million years ago and lasted until the start of the Holocene epoch about 8,000 years ago (Figure 2-3).

REEF Ridgelike or moundlike structure built by sedentary calcareous organisms, especially corals (Figure 3-23).

RELATIVE SEA LEVEL Elevation of the sea surface relative to a local land surface.

RIPPLES Small underwater bed forms with crest-to-crest spacing less than about 0.6 m and height less than about 0.03 m (Figure 4-1).

SEDIMENT Solid fragmented material (sand, gravel, silt, etc.) transported by wind, water, or ice or chemically precipitated from solution or secreted by organisms.

SEICHE A movement back and forth of water in a lake or other mostly enclosed body of water.

SEISMOGRAPH An instrument that records elastic waves in the ground produced by earthquakes, explosions, landslides, or ocean waves.

SELECTIVE SORTING A process occurring during sediment transport that tends to separate particles according to their size, density, and shape.

SHORE A general term applied to the land that directly borders the sea; more specifically, the strip of land extending from the low-water line landward to the normal upper limit of storm wave effects (Figure 2-1).

SHOREFACE A seaward-sloping ramp, seaward of the low-water line that leads to the inner continental shelf and is characteristically steeper than the shelf floor.

SHORELINE The line of demarcation between a shore and the water. May fluctuate periodically due to tide or winds.

SOIL Unconsolidated sediments which contain nutrients, organic matter, etc., and serve as a medium for the growth of land plants.

SPILLOVER LOBE Linguoid, bar-like feature formed by ebb tidal current flow over a low area of an ebb shield (Figure 4-15).

SPIT An elongated, usually sandy, feature aligned parallel to the coast, that terminates in open water (Figure 3-19).

STRAND PLAIN A prograded shore built seawards by waves and currents (Figure 3).

SUBTIDAL Below the low-water datum; thus, permanently submerged.

SWASH BARS Sand bodies that form and migrate across ebb-tidal shoals because of currents generated by breaking waves (Figure 4-15).

SWASH PLATFORM Sand sheet located between the main ebb channel of a coastal inlet and an adjacent barrier island.

TEPHRA Clastic materials ejected from a volcano and transported through the air.

TEPHROCHRONOLOGY The collection, description, and dating of tephra.

THERMOLUMINESCENCE The property, displayed by many minerals, of emitting light when heated.

TIDAL CREEK A creek draining back-barrier areas with a current generated by the rise and fall of the tide.

TIDAL SHOALS Shoals that accumulate near inlets due to the transport of sediments by tidal currents associated with the inlet (Figure 4-15).

TIDES Periodic rise and fall of the ocean surface (primarily in coastal areas) caused by the gravitational interaction among the earth, moon, sun, and, to a lesser degree, other astronomical bodies (Figures 2-4 and 2-12).

TILT Sideways inclination of an aircraft or spaceship.

TROPICAL STORM General term for a low pressure synoptic-scale cyclone that develops in a tropical area.

TSUNAMI Long period wave created by ocean bottom earthquake, submarine landslide, or volcanic explosion. Tsunamis can travel across oceans and flood coastal areas.

UPDRIFT The direction along a coast from which littoral drift material is moving.

VARVE A sedimentary lamina or set of lamina deposited in a body of still water in a year's time.

VOLCANO Vent in the earth's surface through which magma and associated gases and ash erupt. Also refers to the conical-shaped mountain that forms around the vent by the accumulation of rock and ash (Figure 2-8).

WASHOVER Sediment deposited inland of a beach by overwash processes.

WEATHERING Destructive process by which atmospheric or biologic agents change rocks, causing physical disintegration and chemical decomposition.

YAW Refers to an aircraft's or spaceship's turning by angular motion about a vertical axis.

Appendix C Acknowledgements

Table C-1
Authorship and Review of EM 1110-2-1810, "Coastal Geology"

Chapter	Authors	Reviewers *	
1	Andrew Morang, Ph.D. ¹	Edward P. Meisburger ² Joan Pope ¹	John F. C. Sanda ³
2	Andrew Morang, Ph.D. ¹ Larry E. Parson ¹ J. Bailey Smith ¹	Stephan A. Chesser ⁴ Ronald L. Erickson ⁵ James R. Houston, Ph.D. ¹ John H. Lockhart, Jr. ³	Edward P. Meisburger ² Joan Pope ¹ John F. C. Sanda ³ Orson P. Smith, Ph.D. ⁶
3	Andrew Morang, Ph.D. ¹ Laurel T. Gorman ⁷ David B. King, Jr., Ph.D. ¹ (additional text by Edward P. Meisburger ²)	Stephan A. Chesser ⁴ Ronald L. Erickson ⁵ Edward P. Meisburger ²	Joan Pope ¹ John F. C. Sanda ³ Orson P. Smith, Ph.D. ⁶
4	Andrew Morang, Ph.D. ¹ Larry E. Parson ¹	William A. Birkemeier ⁸ Stephan A. Chesser ⁴ Ronald L. Erickson ⁵ Edward B. Hands ¹	Edward P. Meisburger ² Joan Pope ¹ John F. C. Sanda ³ Orson P. Smith, Ph.D. ⁶
5	Andrew Morang, Ph.D. ¹ Laurel T. Gorman ⁶ Robert L. Larson ⁹ Joann Mossa, Ph.D. ¹¹	Stephan A. Chesser ⁴ Ronald L. Erickson ⁵ Paul F. Hadala, Ph.D. ¹⁰ Edward B. Hands ¹ Danny W. Harrelson ⁹	Edward P. Meisburger ² Joan Pope ¹ John F. C. Sanda ³ Orson P. Smith, Ph.D. ⁶
Appendices	Andrew Morang ¹ and other contributors		

Affiliation

* Reviewers are listed alphabetically

¹ Coastal Engineering Research Center, USAE Waterways Experiment Station, Vicksburg, MS

² Coastal Engineering Research Center, USAE Waterways Experiment Station, Vicksburg, MS (retired)

³ Headquarters, US Army Corps of Engineers, Washington, DC

⁴ US Army Engineer District, Portland, Oregon

⁵ US Army Engineer District, Detroit, Michigan

⁶ US Army Engineer District, Alaska, Anchorage, AK

⁷ Information Technology Laboratory, USAE Waterways Experiment Station, Vicksburg, MS

⁸ Field Research Facility, Coastal Engineering Research Center, USAE Waterways Experiment Station, Duck, NC

⁹ Geotechnical Laboratory, USAE Waterways Experiment Station, Vicksburg, MS

¹⁰ Geotechnical Laboratory, USAE Waterways Experiment Station, Vicksburg, MS (retired)

¹¹ Department of Geography, University of Florida, Gainesville, FL

Appendix D List of Wave Information Studies (WIS) Reports

Atlantic, Pacific, and Gulf of Mexico Reports

Corson, W. D., Resio, D. T., and Vincent, C. L. 1980 (July). "Wave Information Study of U.S. Coastlines; Surface Pressure Field Reconstruction for Wave Hindcasting Purposes, TR HL-80-11, Report 1.

Corson, W. D., Resio, D. T., Brooks, R. M., Ebersole, B. A., Jensen, R. E., Ragsdale, D. S., and Tracy, B. A. 1981 (January). "Atlantic Coast Hindcast, Deepwater Significant Wave Information," WIS Report 2.

Corson, W. D., and Resio, D. T. 1981 (May). "Comparisons of Hindcast and Measured Deepwater Significant Wave Heights," WIS Report 3.

Resio, D. T., Vincent, C. L., and Corson, W. D. 1982 (May). "Objective Specification of Atlantic Ocean Windfields from Historical Data," WIS Report 4.

Resio, D. T. 1982 (March). "The Estimation of Wind-Wave Generation in a Discrete Spectral Model," WIS Report 5.

Corson, W. D., Resio, D. T., Brooks, R. M., Ebersole, B. A., Jensen, R. E., Ragsdale, D. S., and Tracy, B. A. 1982 (March). "Atlantic Coast Hindcast Phase II, Significant Wave Information," WIS Report 6.

Ebersole, B. A. 1982 (April). "Atlantic Coast Water-Level Climate," WIS Report 7.

Jensen, R. E. 1983 (September). "Methodology for the Calculation of a Shallow Water Wave Climate," WIS Report 8.

Jensen, R. E. 1983 (January). "Atlantic Coast Hindcast, Shallow-Water Significant Wave Information," WIS Report 9.

Ragsdale, D. S. 1983 (August). "Sea-State Engineering Analysis System: Users Manual," WIS Report 10.

Tracy, B. A. 1982 (May). "Theory and Calculation of the Nonlinear Energy Transfer Between Sea Waves in Deep Water," WIS Report 11.

Resio, D. T., and Tracy, B. A. 1983 (January). "A Numerical Model for Wind-Wave Prediction in Deep Water," WIS Report 12.

Brooks, R. M., and Corson, W. D. 1984 (September). "Summary of Archived Atlantic Coast Wave Information Study: Pressure, Wind, Wave, and Water Level Data," WIS Report 13.

Corson, W. D., Abel, C. E., Brooks, R. M., Farrar, P. D., Groves, B. J., Jensen, R. E., Payne, J. B., Ragsdale, D. S., and Tracy, B. A. 1986 (March). "Pacific Coast Hindcast, Deepwater Wave Information," WIS Report 14.

Corson, W. D., and Tracy, B. A. 1985 (May). "Atlantic Coast Hindcast, Phase II Wave Information: Additional Extremal Estimates," WIS Report 15.

Corson, W. D., Abel, C. E., Brooks, R. M., Farrar, P. D., Groves, B. J., Payne, J. B., McAneny, D. S., and Tracy, B. A. 1987 (May). "Pacific Coast Hindcast Phase II Wave Information," WIS Report 16.

Jensen, R. E., Hubertz, J. M., and Payne, J. B. 1989 (March). "Pacific Coast Hindcast, Phase III North Wave Information," WIS Report 17.

Hubertz, J. M., and Brooks, R. M. 1989 (March). "Gulf of Mexico Hindcast Wave Information," WIS Report 18.

Able, C. E., Tracy, B. A., Vincent, C. L., and Jensen, R. E. 1989 (April). "Hurricane Hindcast Methodology and Wave Statistics for Atlantic and Gulf Hurricanes from 1956-1975," WIS Report 19.

Jensen, R. E., Hubertz, J. M., Thompson, E. F., Reinhard, R. D., Borup, B. J., Brandon, W. A., Payne, J. B., Brooks, R. M., and McAneny, D. S. 1992 (December). "Southern California Hindcast Wave Information," WIS Report 20.

Tracy, B. A., and Hubertz, J. M. 1990 (November). "Hindcast Hurricane Swell for the Coast of Southern California," WIS Report 21.

Hubertz, J. M., and Brooks, R. M. 1992 (September). "Verification of the Gulf of Mexico Hindcast Wave Information," WIS Report 28.

31 Jan 95

Great Lakes Reports

Resio, D. T., and Vincent, C. L. 1976 (January). "Design Wave Information for the Great Lakes; Report 1: Lake Erie," TR H-76-1.

Resio, D. T., and Vincent, C. L. 1976 (March). "Design Wave Information for the Great Lakes; Report 2: Lake Ontario," TR H-76-1.

Resio, D. T., and Vincent, C. L. 1976 (June). "Estimation of Winds Over Great Lakes," MP H-76-12.

Resio, D. T., and Vincent, C. L. 1976 (November). "Design Wave Information for the Great Lakes; Report 3: Lake Michigan," TR H-76-1.

Resio, D. T., and Vincent, C. L. 1977 (March). "Seasonal Variations in Great Lakes Design Wave Heights: Lake Erie," MP H-76-21.

Resio, D. T., and Vincent, C. L. 1977 (August). "A Numerical Hindcast Model for Wave Spectra on Water Bodies with Irregular Shoreline Geometry; Report 1, Test of Nondimensional Growth Rates," MP H-77-9.

Resio, D. T., and Vincent, C. L. 1977 (September). "Design Wave Information for the Great Lakes; Report 4, Lake Huron," TR H-76-1.

Resio, D. T., and Vincent, C. L. 1978 (June). "Design Wave Information for the Great Lakes; Report 5, Lake Superior," TR H-76-1.

Resio, D. T., and Vincent, C. L. 1978 (December). "A Numerical Hindcast Model for Wave Spectra on Water

Bodies with Irregular Shoreline Geometry, Model Verification with Observed Wave Data," Report 2, MP H-77-9.

Driver, D. B., Reinhard, R. D., and Hubertz, J. M. 1991 (October). "Hindcast Wave Information for the Great Lakes: Lake Erie," WIS Report 22.

Hubertz, J. M., Driver, D. B., and Reinhard, R. D. 1991 (October). "Hindcast Wave Information for the Great Lakes: Lake Michigan," WIS Report 24.

Reinhard, R. D., Driver, D. B., and Hubertz, J. M. 1991 (December). "Hindcast Wave Information for the Great Lakes: Lake Ontario," WIS Report 25.

Reinhard, R. D., Driver, D. B., and Hubertz, J. M. 1991 (December). "Hindcast Wave Information for the Great Lakes: Lake Huron," WIS Report 26.

Driver, D. B., Reinhard, R. D., and Hubertz, J. M. 1992 (January). "Hindcast Wave Information for the Great Lakes: Lake Superior," WIS Report 23.

General User's Information

Hubertz, J. M. 1992 (June). "User's Guide to the Wave Information Studies (WIS) Wave Model, Version 2.0," WIS Report 27.

NOTE:

All reports listed above were published by and are available from the U.S. Army Engineer Waterways Experiment Station, Coastal Engineering Research Center, 3909 Halls Ferry Road, Vicksburg, MS 39180-6199.

Appendix E List of Selected Sources for Aerial Photography and Other Remote Sensing Data

Agricultural Stabilization and Conservation Service
(ASCS)
Aerial Photography Field Office
2222 West 2300 South
P.O. Box 30010
Salt Lake City, UT 84130
(801)524-5856

Soil Conservation Service (SCS)
Cartographic Division
P.O. Box 269
101 Catalpa Drive
Lapalta, MD 20646
(301)870-3555

Bonneville Power Administration (BPA)
Photogrammetry Unit
905 NE 11th Ave
Rt. EFBK
Portland, OR 97208
(503)230-4643

Bureau of Land Management (BLM)
Service Center
Denver Federal Center, Building 50
P.O. Box 25047
Denver, CO 80225-0047
(303)236-6452

Defense Intelligence Agency (DIA)
Clarenton Square Building
3033 Wilson Blvd
Arlington, VA 22201
(703)284-1124

Susquehanna River Basin Commission (SRBC)
1721 N. Front Street
Harrisburg, PA 17102
(717)638-0422

National Ocean Survey (NOS)
Coastal Mapping Division, C-3415
Rockville, MD 20852
(301)713-0610

U.S. Forest Service (USFS)
Division of Engineering
Washington, DC 20250
(202)205-1400

USFS Regional Offices:

Regional Forester
U.S. Forest Service
Federal Building
P.O. Box 7669
Missoula, MT 59807
(406)326-3511

Regional Forester
U.S. Forest Service
11177 W 8th Ave
Box 25127
Lakewood, CO 80225
(303)236-9427

Regional Forester
U.S. Forest Service
324 25th St.
Ogden, UT 84401
(801)625-5605

Regional Forester
U.S. Forest Service
Printing and Reproduction Section, Room 548
630 Sansome Street
San Francisco, CA 94111
(415)705-2870

Regional Forester
U.S. Forest Service
333 SW First
Portland, OR 97204-3304

Regional Forester
U.S. Forest Service
1720 Peachtree Road, NW
Atlanta, GA 30367
(404)347-4177

Regional Forester
U.S. Forest Service
310 W. Wisconsin Avenue
Milwaukee, WI 53203
(414)297-3693

EM 1110-2-1810
31 Jan 95

Regional Forester
U.S. Forest Service
P.O. Box 21628
Juneau, AK 99802-1628
(907)586-8863

U.S. Bureau of Reclamation (USBR)
Engineering and Research Center
P.O. Box 25007
Denver, CO 80225
(303)236-8098)

USBR Regional Offices:

Pacific Northwest Region
Federal Building
550 W. Fort Street, Box 043
Boise, ID 83724-0043
(208)334-1938

Mid-Pacific Region
Federal Office Building
2800 Cottage Way
Sacramento, CA 95825
(916)978-5135

Lower Colorado Region
P.O. Box 61470
Boulder City, NE 89006-1470
(702)293-8411

Upper Colorado Region
P.O. Box 11568
Salt Lake City, UT 84147
(801)542-5592

Great Plains
P.O. Box 36900
Billings, MT 59107-6900
(406)657-6214

U.S. Geological Survey (USGS)
Mid-Continent Mapping Center
Map and Field Data Section
1400 Independence Rd
Rolla, MO 65401
(314)341-0800

U.S. Geological Survey (USGS)
Rocky Mountain Mapping Center
Map and Field Data Section
Federal Center, Building 25
Denver, CO 80225
(303)236-5825

U.S. Geological Survey (USGS)
Western Mapping Center
Map and Field Data Section
345 Middlefield Road
Menlo Park, CA 94025
(415)329-4254

U.S. Geological Survey (USGS)
Eastern Mapping Center
Mapping and Field Data Section
536 National Center
Reston, VA 22092
(703)648-6002

U.S. Geological Survey (USGS)
Earth Resources Observation Systems
(EROS) Data Center
10th and Dakota Avenue
Sioux Falls, SD 57198
(605)594-7123

U.S. Geological Survey (USGS)
EROS Applications Assistance Facility
Stennis Space Center, Bldg 101
Bay St. Louis, MS 39529
(601)688-3541

EOSAT Corporation (LANDSAT images and digital products)
4300 Forbes Boulevard
Lanham, MD 20706
(301)552-0537 FAX: (301)552-0507

Hughes STX Satellite Mapping Technologies
(Almaz-1 Synthetic Aperture Radar Satellite Data)
4400 Forbes Boulevard
Lanham, MD 20706-4392
(301)794-5330 FAX: (301)306-0963

SPOT Image Corporation (SPOT images and digital products)
1897 Preston White Drive
Reston, VA 22091-4368
(703)620-2200 FAX: (703)648-1813

NOAA/National Environmental Satellite, Data & Information Service
(NOAA meteorological satellite images and digital products)
World Weather Building, Room 100
Washington, DC 20233
(202)377-2985

Appendix F Addresses of Government Agencies Producing Maps

FEDERAL GOVERNMENT

Defense Mapping Topographic Center
4600 Sangamore Rd
Bethesda, MD 20816-5003
(301)227-2050

Federal Communications Commission
Office of Public Information
1919 M Street NW
Washington, DC 20554
(202)632-7106

Federal Railroad Administration
Office of Public Affairs, ROA-30
400 Seventh Street NW
Washington, DC 20590
(202)366-0881

International Boundary Commission
United States and Canada
1250 23rd St. NW, Suite 3405
Washington, DC 20037
(202)736-9100

International Boundary and Water Commission
United States and Mexico, United States Section
Commons Bldg. C, Suite 310
4171 North Mesa
El Paso, TX 79902-1422
(915)534-6700

Interstate Commerce Commission
Office of Public Information
12th St. & Constitution Ave. NW
Washington, DC 20423
(202)927-7119

Library of Congress
Geography and Map Division
James Madison Memorial
101 Independence Ave, SE
Washington, DC 20540
(202)707-8530

Tennessee Valley Authority
Mapping Services Branch
111 Haney Building
Chattanooga, TN 37402-2801
(615)751-6277

U.S. Army Engineer District
Corps of Engineers, Chicago
111 N. Canal Street, Suite 600
Chicago, IL 60606-7206
(312)353-6400

U.S. Army Engineer District
Corps of Engineers, Louisville
Post Office Box 59
Louisville, KY 40201-0059
(502)582-5639

U.S. Army Engineer District
Corps of Engineers, Nashville
Post Office Box 1070
Nashville, TN 37202-1070
(615)736-7161

U.S. Army Engineer District
Corps of Engineers, Omaha
215 North 17th Street
Omaha, NE 68102
(402)221-3917

U.S. Army Engineer District
Corps of Engineers, Vicksburg
2101 N. Frontage Road
Post Office Box 60
Vicksburg, MS 39181-0060
(601)634-5000

U.S. Bureau of the Census
Subscriber Service Section (Pubs)
Administrative Service Division
Washington, DC 20233
(301)763-4051

U.S. Bureau of Indian Affairs
Office of Public Information
1849 Sea Street, NW
Washington, DC 20240-2620
(202)208-3711

EM 1110-2-1810
31 Jan 95

U.S. Bureau of Land Management
Office of Public Affairs
1849 Sea Street, NW, RM 5600 MIB
Washington, DC 20240-9998
(202)208-3435

U.S. Geological Survey
Branch of Distribution
Box 25286, Federal Center
Denver, CO 80225
(303)236-7477

U.S. National Archives and Records Service
Cartographic Archives Division (NNSC)
Washington, DC 20408
(703)756-6700

U.S. National Climatic Center
Federal Building
Asheville, NC 28801
(704)259-0682

U.S. National Ocean Survey
Coastal Ocean Program
1100 Wayne Ave.
Silverspring, MD 20910
(301)427-2089

U.S. National Park Service
Office of Public Inquiries, Room 3045
P.O. Box 37127
Washington, DC 20013-7127
(202)208-4621

U.S. National Weather Service
1325 EW Highway
Silver Spring, MD 20910
(301)713-0689

U.S. Soil Conservation Service
Information Division
Post Office Box 2890
Washington, DC 20013

State Highway Departments

State Capitals

Appendix G Geographic List of Coastal Engineering Research Center (CERC) Coastal Geo- logic and Monitoring Reports

This appendix lists reports published by CERC and its predecessor, the Beach Erosion Board (BEB), pertaining to coastal projects where field data have been collected. Many of the reports contain data that are no longer available from any other source (for example, core boring logs, isopach maps of sediment thickness, and beach profiles). Reports of physical or numerical model studies are not included in this list.

Reports are cataloged according to the geographic location where the bulk of the research was conducted. The main categories are: Atlantic coast; Gulf of Mexico coast; Alaska and the Pacific Islands; Pacific coast; and the Great Lakes. Each region is subdivided by states, or, for the Great Lakes, by individual lake. On the Atlantic coast, states are listed north to south; the Gulf coast: east to west; the Pacific coast: north to south. Within each state, entries are alphabetized by author.

Publication information:

1930 to 1963: BEB Technical Memorandums were issued by the U.S. Army Corps of Engineers.

1963 to 1973: CERC Technical Memorandums were issued by CERC, U.S. Army Corps of Engineers, Washington, D.C.

1973 to 1983: CERC reports and papers were published by CERC, Fort Belvoir, Virginia.

1983 to Present: CERC Technical Reports (TR), Instruction Reports (IR), Contract Reports (CR), and Miscellaneous Papers (MP) have been published by the U.S. Army Engineer Waterways Experiment Station (WES), Vicksburg, Mississippi.

The General Investigation of Tidal Inlets (GITI) program was jointly conducted by CERC and WES; publication was at Vicksburg, MS.

The WES library has copies of most CERC documents. These are available to Department of Defense agencies on interlibrary loan. Reports are also available from many U.S. Army Engineer Districts and Divisions and from

some university libraries. Publications which can not be located in libraries can be purchased from:

National Technical Information Service (NTIS)
5285 Port Royal Road
Springfield, Virginia 22161
(703) 487-4650

When ordering from NTIS, the accession number of the report should be specified (listed at the end of most citations).

The following bibliographies contain comprehensive lists of early CERC and BEB reports:

Allen, R. H., and Spooner, E. L. 1968. "Annotated Bibliography of BEB and CERC Publications, Miscellaneous Paper 1-68. A673 721

Szuwalski, A., and Wagner, S. 1984. "Bibliography of Publications Prior to July 1983 of the Coastal Engineering Research Center and the Beach Erosion Board."

A. Atlantic coast

1. General

Birkemeier, W. A., Savage, R. J., and Leffler, M. W. 1988. "A Collection of Storm Erosion Field Data," Miscellaneous Paper CERC-88-9. A198 433

Everts, C. H. 1978. "Geometry of Profiles Across Inner Continental Shelves of the Atlantic and Gulf Coasts of the United States," Technical Paper 78-4. A055 876

Lillycrop, J. W., and Hughes, S. A. 1993. "Scour Hole Problems Experienced by the Corps of Engineers; Data Presentation and Summary," Miscellaneous Paper CERC-93-2.

Meisburger, E. P. 1989. "Shore Normal Distribution of Heavy Minerals on Ocean Beaches: Southeast Atlantic Coast," Miscellaneous Paper CERC-89-8. A210 258

2. Maine

3. New Hampshire

4. Massachusetts

Boothroyd, J. C., and Hubbard, D. K. 1974. "Bed Form Development and Distribution Pattern, Parker and Essex Estuaries, Massachusetts," Miscellaneous Paper 1-74. 777 911

Dewall, A. E., Tarnowski, J. A., Danielson, B., and Weishar, L. L. 1984. "Inlet Processes at Eel Pond, Falmouth, Massachusetts," Miscellaneous Paper CERC-84-9. A147 548

Knutson, P. L. 1980. "Experimental Dune Restoration and Stabilization, Nauset Beach, Cape Cod, Massachusetts," Technical Paper 80-5. A092 110

Meisburger, E. P. 1976. "Geomorphology and Sediments of Western Massachusetts Bay," Technical Paper 76-3. A025 444

Rhodes, E. G. 1973. "Pleistocene-Holocene Sediments Interpreted by Seismic Refraction and Wash-Bore Sampling, Plum Island-Castle Neck, Massachusetts," Technical Memorandum TM 40. 768 791

Smith, J. B. 1991. "Morphodynamics and Stratigraphy of Essex River Ebb-Tidal Delta: Massachusetts," Technical Report CERC-91-11. A241 424

Weishar, L. L., and Aubrey, D. G. 1988. "Inlet Hydraulics at Green Harbor, Marshfield, Massachusetts," Miscellaneous Paper CERC-88-10. A198 196

5. Rhode Island

LeBlanc, C., and Bottin, R. R., Jr. 1992. "Monitoring of the Beach Erosion Control Project at Oakland Beach, Rhode Island," Miscellaneous Paper CERC-92-7. A255 831

Miller, M. C., and Aubrey, D. C. 1985. "Beach Changes on Eastern Cape Cod, Massachusetts, from Newcomb Hollow to Nauset Inlet, 1970-1974," Miscellaneous Paper CERC-85-10. A163 155

Morton, R. W., Bohlen, W. F., Aubrey, D. G., and Miller, M. C. 1984. "Beach Changes at Misquamicut Beach, Rhode Island, 1962-1973," Miscellaneous Paper CERC-84-12. A150 233

6. Connecticut

Morton, R. W., Bohlen, W. F., and Aubrey, D. G. 1983. "Beach Changes at Milford and Fairfield Beaches, Connecticut," Miscellaneous Paper CERC-83-5. A137 253

Vesper, W. H. 1961. "Behavior of Beach Fill and Borrow Area at Prospect Beach, West Haven, Connecticut," BEB Technical Memorandum TM 127. 266 262

Vesper, W. H. 1967. "Behavior of Beach Fill and Borrow Area at Sherwood Island State Park, Westport, Connecticut," Technical Memorandum TM 20. 655 260

Vesper, W. H. 1965. "Behavior of Beach Fill and Borrow Area at Seaside Park, Bridgeport, Connecticut," Technical Memorandum TM 11. 615 791

7. New York

DeWall, A. E. 1979. "Beach Changes at Westhampton Beach, New York, 1962-73," Miscellaneous Report 79-5. A073 605

Morton, R. W., Bohlen, W. F., and Aubrey, D. G. 1986. "Beach Changes at Jones Beach, Long Island, New York, 1962-74," Miscellaneous Paper CERC-86-1. A167 664

Pararas-Carayannis, G. 1973. "Ocean Dumping in the New York Bight: An Assessment of Environmental Studies," Technical Memorandum TM 39. 766 721

Parker, J. H., and Valente, R. M. 1988. "Long-term Sand Cap Stability: New York Dredged Material Disposal Sites," Contract Report CERC-88-2. A198 651

Taney, N. E. 1961. "Littoral Materials of the South Shore of Long Island, New York," BEB Technical Memorandum TM 129. 271 022

Taney, N. E. 1961. "Geomorphology of the South Shore of Long Island, New York," BEB Technical Memorandum TM 128. 266 264

Williams, S. J. 1976. "Geomorphology, Shallow Subbottom Structure, and Sediments of the Atlantic Inner Continental Shelf Off Long Island, New York," Technical Paper 76-2. A025 467

Williams, S. J., and Duane, D. B. 1974. "Geomorphology and Sediments of the Inner New York Bight Continental Shelf," Technical Memorandum TM 45. 785 577

Williams, S. J. 1981. "Sand Resources and Geological Character of Long Island Sound," Technical Paper 81-3. A104 082

Fairchild, J. C. 1966. "Correlation of Littoral Transport with Wave Energy Along Shores of New York and New Jersey," Technical Memorandum TM 20. 647 213

8. New Jersey

Brown, W. A., Abel, C. E., Chen, H. S., Corson, W. D. and Thompson, E. W. 1988. "Wave Conditions at Barnegat Inlet, New Jersey, 10 November 1984," Miscellaneous Paper CERC-88-5. A194 335

Everts, C. H., DeWall, A. E., and Czerniak, M. T. 1980. "Beach and Inlet Changes at Ludlam Beach, New Jersey Beaches," Miscellaneous Report 80-3. A087 796

Fairchild, J. C. 1977. "Suspended Sediment in the Littoral Zone at Ventnor, New Jersey and Nags Head, North Carolina," Technical Report 77-5. A042 061

Ferland, M. A. 1990. "Holocene Depositional History of the Southern New Jersey Barrier and Backbarrier Regions," Technical Report CERC-90-2. A220 085

Gebert, J. A. , and Hemsley, J. M. 1991. "Monitoring of Jetty Rehabilitation at Manasquan inlet, New Jersey," Miscellaneous Paper CERC-91-8. A241 585

Gravens, M. B., Scheffner, N. W., and Hubertz, J. M. 1989. "Coastal Processes from Asbury Park to Manasquan, New Jersey," Miscellaneous Paper CERC-89-11. A213 533

Harris, R. L. 1954. "Restudy of Test-Shore Nourishment by Offshore Deposition of Sand, Long Branch, New Jersey," BEB Technical Memorandum TM 62. 55 554

Kraus, N. C., Scheffner, N. W., Hanson, H., Chou, L. W., Cialone, M. A., Kraus, N. C., Gravens, M. B., and Mark, D. J. 1988. "Coastal Processes at Sea Bright to Ocean Township, New Jersey; Volume I: Main text and Appendix A; Volume II: Appendixes B through G," Miscellaneous Paper CERC-88-12. A198 896

McCann, D. P. 1981. "Beach Changes at Atlantic City, New Jersey (1962-73)," Miscellaneous Report 81-3. A101 902

Meisburger, E. P., and Williams, S. J. 1980. "Sand Resources on the Inner Continental Shelf of the Cape May Region, New Jersey," Miscellaneous Report 80-4. A088 636

Meisburger, E. P., and Williams, S. J. 1982. "Sand Resources on the Inner Continental Shelf Off the Central New Jersey Coast," Miscellaneous Report 82-10. A123 087

DeWall, A. E., Pritchett, P. C., and Galvin, C. J., Jr. 1977. "Beach Changes Caused by the Atlantic Coast Storm of 17 December 1970," Technical Report 77-1. A037 378

Miller, M. C., Aubrey, D. G., and Karpen, J. 1980. "Beach Changes at Long Beach Island, New Jersey, 1962-73," Miscellaneous Report 80-9. A101 844

Ramsey, M. D., and Galvin, C. J., Jr. 1977. "Size Analysis of Sand Samples from Southern New Jersey Beaches," Miscellaneous Report 77-3. A040 082

Vesper, W. H., and Essick, M. G. 1964. "A Pictorial History of Selected Structures Along the New Jersey Coasts," Miscellaneous Paper 5-64. 612 764

Watts, G. M. 1956. "Behavior of Beach Fill at Ocean City, New Jersey," BEB Technical Memorandums TM 77. 115 380

9. Delaware

Field, M. E. 1979. "Sediments, Shallow Subbottom Structure, and Sand Resources of the Inner Continental Shelf, Central Delmarva Peninsula," Technical Paper 79-2. A074 022

10. Maryland

Anders, F. J., and Hansen, M. 1990. "Beach and Borrow Site Sediment Investigation for a Beach Nourishment at Ocean City, Maryland," Technical Report CERC-90-5. A222 251

Leffler, M. W., Smith, E. R., and Mason, C. 1986. "1984 Nearshore Surveys and Sediment Sampling, Assateague Island, Maryland," Miscellaneous Paper CERC-86-5. A168 726

11. Virginia

Chao, Y. Y. 1974. "Wave Refraction Phenomena Over the Continental Shelf Near the Chesapeake Bay Entrance," Technical Memorandum TM 47. 002 056

Everts, C. H., Battley, P. P., Jr., and Gibson, P. N. 1983. "Shoreline Movements; Report 1: Cape Henry, Virginia, to Cape Hatteras, North Carolina, 1849-1980," Technical Report CERC-83-1. A128 933

Goldsmith, V., Strum, S. C., and Thomas, G. R. 1977. "Beach Erosion and Accretion at Virginia Beach, Virginia, and Vicinity," Miscellaneous Report 77-12. A049 563

Harrison, W., and Wagner, K. A. 1974. "Beach Changes at Virginia Beach, Virginia," Miscellaneous Paper 6-64. 612 765

Harrison, W., and Alamo, R. M. 1964. "Dynamic Properties of Immersed Sand at Virginia Beach, Virginia," Technical Memorandum TM 9. 459 520

Harrison, W., Brehmer, M. L. and Stone, R. B. 1964. "Nearshore Tidal and Nontidal Currents, Virginia Beach, Virginia," Technical Memorandum TM 5. 440 881

Harrison, W., Krumbein, W. C. and Wilson, W. 1964. "Sedimentation at an Inlet Entrance--Rudee Inlet-Virginia Beach, Virginia," Technical Memorandum TM 8. 459 085

Meisburger, E. P. 1972. "Geomorphology and Sediments of the Chesapeake Bay Entrance," Technical Memorandum TM 38. 749 545

Rosati, J. D., and Pope, J. 1989. "The Colonial Beach, Virginia, Detached Breakwater Project," Miscellaneous Paper CERC-89-2.

Thevenot, M. M., Prickett, T. L., and Kraus, N. C. (Eds.) 1992. "Tyler's Beach, Virginia, Dredged Material Plume Monitoring Project, 27 September to 4 October 1991," Technical Report DRP-92-7.

Watts, G. M. 1959. "Behavior of Beach Fill at Virginia Beach, Virginia," BEB Technical Memorandum 113. 227 462

12. North Carolina

Annual data summaries for the Field Research Facility, Duck, North Carolina:

1977-79: Miscellaneous Report CERC-82-16
1980: Technical Report CERC-84-1
1981: Technical Report CERC-85-3
1982: Technical Report CERC-86-5

1983: Technical Report CERC-86-9
1984: Technical Report CERC-86-11 A175 773
1985: Technical Report CERC-87-13 A186 442
1986: Technical Report CERC-88-8 A197 853
1987: Vol 1: Technical Report CERC-89-10 A212 803
Vol 2: Technical Report CERC-89-10 A212 823
1988: Vol 1: Technical Report CERC-90-13 A225 687
Vol 2: Technical Report CERC-90-13 A226 429
1989: Vol 1: Technical Report CERC-91-9/1 A241 586
Vol 2: Technical Report CERC-91-9/2 A241 155
1990: Technical Report CERC-92-3 (Vols 1 and 2) A250 563
1991: Technical Report CERC-93-9 (Vols 1 and 2)

Birkemeier, W. A., Miller, H. C., Wilhelm, S. D., and Dewall, A. E. 1985. "A User's Guide to the Coastal Engineering Research Center's (CERC'S) Field Research Facility," Instruction Report CERC-85-1. A157 966

Diaz, R. J., and DeAlteris, J. T. 1982. "Long-term Changes in Beach Fauna at Duck, North Carolina," Miscellaneous Report 82-12. A125 142

Escoffier, F. F. 1977. "Hydraulics and Stability of Tidal Inlets," General Investigations of Tidal Inlets GITI 13. A045 523

Forman, J. W. 1986. "Generalized Monitoring of Seascape Installation at Cape Hatteras Lighthouse, North Carolina," Miscellaneous Paper CERC-86-2. A167 341

Harris, D. L., and Bodine, B. R. 1977. "Comparison of Numerical and Physical Hydraulic Models, Masonboro Inlet, North Carolina," Main text and Appendices 1-4, General Investigations of Tidal Inlets GITI 6. A052 795

Harris, R. L., Levy, G. F., and Perry, J. E. 1983. "Reevaluation of Vegetational Characteristics at the CERC Field Research Facility, Duck, North Carolina," Miscellaneous Report 83-4. A127 137

Howd, P. A., and Birkemeier, W. A. 1987. "Beach and Nearshore Survey Data: 1981-1984, CERC Field Research Facility," Technical Report CERC-87-9.

Hubertz, J. M., Long, C. E., Rivers, P., and Brown, W. A. 1987. "DUCK '85, Nearshore Waves and Currents Experiment, Data Summary Report," Miscellaneous Paper CERC-87-3. A177 419

- Lee, G. H., and Birkemeier, W. A. 1993. "Beach and Nearshore Survey Data: 1985-1991 CERC Field Research Facility," Technical Report CERC-93-3.
- Hubertz, J. M., Long, C. E., Rivers, P., and Brown, W. A. 1987. "Duck '85, Nearshore Waves and Currents Experiment, Data Summary Report," Miscellaneous Paper CERC-87-3. A177 419
- Long, C. E. 1991. "Index and Bulk Parameters for Frequency-Direction Spectra Measured at CERC Field Research Facility, September 1986 to August 1987," Miscellaneous Paper CERC-91-6. A241 239
- Long, C. E., and Smith, W. L. 1993. "Index and Bulk Parameters for Frequency-Direction Spectra Measured at CERC Field Research Facility, September 1988 to August 1989," Miscellaneous Paper CERC-99-1.
- Jarrett, T. J., and Hemsley, M. J. 1988. "Beach Fill and Sediment Trap at Carolina Beach, North Carolina," Technical Report CERC-88-7. A197 835
- Matta, J. F. 1977. "Beach Fauna Study of the CERC Field Research Facility, Duck, North Carolina," Miscellaneous Report 77-6. A040 593
- Meisburger, E. P. 1977. "Sand Resources on the Inner Continental Shelf of the Cape Fear Region," Miscellaneous Report 77-11. A049 132
- Meisburger, E. P. 1979. "Reconnaissance Geology of the Inner Continental Shelf, Cape Fear Region, North Carolina," Technical Report 79-3. A076 974
- Meisburger, E. P., Williams, S. J., and Judge, C. 1989. "Physiographic and Geological Setting of the Coastal Engineering Research Center's Field Research Facility," Miscellaneous Paper CERC-89-9. A210 772
- Miller, M. C. 1983. "Beach Changes at Holden Beach, North Carolina, 1970-74," Miscellaneous Report 83-5. A127 986
- Miller, G. H. 1976. "An ERTS-1 Study of Coastal Features on the North Carolina Coast," Miscellaneous Report 76-2. A022 336
- Reilly, F. J., and Bellis, V. J. 1983. "The Ecological Impact of Beach Nourishment with Dredged Materials on the Intertidal Zone at Bogue Banks, North Carolina," Miscellaneous Report 83-3. A128 925
- Sager, R. A., and Seabergh, W. C. 1977. "Physical Model Simulation of the Hydraulics of Masonboro Inlet, North Carolina," General Investigations of Tidal Inlets GITI 16. A045 523
- Schwartz, R. K., and Musialowski, F. R. 1980. "Transport of Dredged Sediment Placed in the Nearshore Zone--Currituck Sand-Bypass Study (Phase I)," Technical Report 80-1. A084 186
- Stafford, D. B. 1971. "An Aerial Photographic Technique for Beach Erosion Surveys in North Carolina," Technical Memorandum TM 36. 732 833
- Stauble, D. K. 1992. "Long-term Profile and Sediment Morphodynamics: Field Research Facility Case History," Technical Report CERC-92-7.
- Stauble, D. K., Holem, G. W., Byrnes, M. A., Anders, F. J., and Meisburger, E. P. 1993. "SUPERDUCK Beach Sediment Sample Experiment: Beach Profile Change and Foreshore Sediment Dynamics," Technical Report CERC-93-4.
- Winton, T. C., et al. 1981. "Analysis of Coastal Sediment Transport Processes from Wrightsville Beach to Fort Fisher, North Carolina," Miscellaneous Report 81-6. A103 168
- Woodhouse, W. W., and Hanes, R. E. 1967. "Dune Stabilization with Vegetation on the Outer Banks of North Carolina," Technical Memorandum TM 22. 659 341

13. South Carolina

- Chasten, M. A. 1992. "Coastal Response to a Dual Jetty System at Little River Inlet, North and South Carolina," Miscellaneous Paper CERC-92-2.
- Chasten, M. A., and Seabergh, W. C. 1992. "Engineering Assessment of Hydrodynamics and Jetty Scour at Little River Inlet, North and South Carolina," Miscellaneous Paper CERC-92-10.
- Douglass, S. L. 1987. "Coastal Responses to Navigation Structures at Murrells Inlet, South Carolina: Main Text and Appendices A and B," Technical Report CERC-87-2. A179 044
- "Appendices C through H," Technical Report CERC-87-2. A179 045

Finley, R. J. 1976. "Hydraulics and Dynamics of North Inlet, South Carolina, 1974-75, General Investigations of Tidal Inlets GITI 10. A033 419

Nummedal, D., and Humphries, S. M. 1978. "Hydraulics and Dynamics of North Inlet, South Carolina, 1975-76," General Investigations of Tidal Inlets GITI 16. A063 986

14. Georgia

Neiheisel, J. 1965. "Source and Distribution of Sediments at Brunswick Harbor and Vicinity, Georgia," Technical Memorandum TM 12. 620 873

Oertel, G. F., Fowler, J. E., and Pope, J. 1985. "History of Erosion and Erosion Control Efforts at Tynbee Island, Georgia," Miscellaneous Paper CERC-85-1. A156 971

15. Florida

Courtenay, W. R., Hartig, B. C., and Loisel, G. R. 1980. "Evaluation of Fish Populations Adjacent to Borrow Areas of Beach Nourishment Project, Hallandale (Broward County), Florida," Miscellaneous Report 80-1 (I). A083 595

Courtenay, W. R., et al. 1974. "Ecological Monitoring of Beach Erosion Control Projects, Broward County, Florida, and Adjacent Areas," Technical Memorandum TM 41. 778 733

DeWall, A. E. 1977. "Littoral Environment Observations and Beach Changes Along the Southeast Florida Coast," Technical Report 77-10. A047 608

Duane, D. B., and Meisburger, E. P. 1969. "Geomorphology and Sediments of the Nearshore Continental Shelf, Miami to Palm Beach, Florida," Technical Memorandum TM 29. 699 339

Ferland, M. A., and Weishar, L. L. 1984. "Interpretative Analysis of Surficial Sediments as an Aid in Transport Studies of Dredged Materials, Cape Canaveral, Florida," Miscellaneous Paper CERC-84-3. A140 759

Field, M. E., and Duane, D. B. 1974. "Geomorphology and Sediments of the Inner Continental Shelf, Cape Canaveral, Florida," Technical Memorandum TM 42. 779 513

Hemsley, M. J., and Briggs, M. J. 1988. "Tidal Elevation and Currents at Ponce de Leon Inlet, Florida," Miscellaneous Paper CERC-88-8. A195 872

Marsh, G. A., et al. 1980. "Evaluation of Benthic Communities Adjacent to a Restored Beach, Hallandale (Broward County), Florida," Miscellaneous Report 80-1 (II). A085 802

Meisburger, E. P. 1989. "Oolites as a Natural Tracer in Beaches of Southeastern Florida," Miscellaneous Paper CERC-89-10. A211 323

Meisburger, E. P. 1989. "Possible Interchange of Sediments Between a Beach and Offlying Linear Shoal," Technical Report CERC-89-6. A210 256

Meisburger, E. P., and Duane, D. B. 1971. "Geomorphology and Sediments of the Inner Continental Shelf, Palm Beach to Cape Kennedy, Florida," Technical Memorandum TM 34. 724 135

Meisburger, E. P., and Field, M. E. 1975. "Geomorphology, Shallow Structure, and Sediments of the Florida Inner Continental Shelf, Cape Canaveral to Georgia," Technical Memorandum TM 54. A015 022

Turbeville, D. B., and Marsh, G. A. 1982. "Benthic Fauna of an Offshore Borrow Area in Broward County, Florida," Miscellaneous Report 82-1. A110 666

Watts, G. M. 1953. "A Study of Sand Movement at South Lake Worth Inlet, Florida," BEB Technical Memorandum TM 42. 24 439

B. Gulf of Mexico coast

1. General

Garcia, A. W. 1990. "Hurricane Gilbert Storm Surge Data," Miscellaneous Paper CERC-90-1. A218 752

2. Florida

Balsillie, J. H. 1975. "Analysis and Interpretation of Littoral Environment Observation (LEO) and Profile Data Along the Western Panhandle Coast of Florida," Technical Memorandum TM 49. A009 755

Chu, Y. H., and Martin, T. 1992. "Beach Response to the Redington Shores, Florida Breakwater," Miscellaneous Paper CERC-92-8. A256 157

Culter, J. K., and Mahadevan, S. 1982. "Long-term Effects of Beach Nourishment on the Benthic Fauna of Panama City Beach, Florida," Miscellaneous Report 82-2. A115 212

Garcia, A. W., and Hegge, W. S. 1987. "Hurricane Kate Storm Surge Data Report," Technical Report CERC-87-12. A186 374

Lillicrop, J. W., Rosati, J. D., and McGehee, D. D. 1989. "A Study of Sand Waves in the Panama City, Florida Entrance Channel," Technical Report CERC-89-7. A211 123

Morang, A. 1992. "A Study of Geologic and Hydraulic Processes at East Pass, Destin, Florida; Volume 1: Main Text and Appendices A and B," Technical Report CERC-92-5/1. A253 890

Volume 2: Appendices C through K, Technical Report CERC-92-5/2. A254 877

Rosati, J. D., Gingerich, K. J., and Kraus, N. C. 1991. "East Pass and Ludington Sand Transport Data Collection Projects; Data Report," Miscellaneous Paper CERC-91-3. A239 304

Saloman, C. H., Naughton, S. P., and Taylor, J. L. 1982. "Benthic Community Response to Dredging Borrow Pits, Panama City Beach, Florida," Miscellaneous Report 82-3. A116 340

3. Alabama

Garcia, A. W., and Hegge, W. S. 1987. "Hurricane Elena Storm Surge Data Report 3," Technical Report CERC-87-10. A184 573

4. Mississippi

Outlaw, D. G. 1985. "Prototype Tidal Data Analysis for Mississippi Sound and Adjacent Areas," Miscellaneous Paper CERC-83-1. A134 071

Watts, G. M. 1958. "Behavior of Beach Fill and Borrow Area at Harrison County, Mississippi," BEB Technical Memorandum TM 107. 216 608

5. Louisiana

Britsch, L. D. 1986. "Migration of Isles Dernieres: Past and Future," Technical Report CERC-86-6. A172 504

Garcia, A. W., and Hegge, W. S. 1987. "Hurricane Danny Storm Surge Data," Technical Report CERC-87-11.

6. Texas

Behrens, E. W., Watson, R. L., and Mason, C. 1977. "Hydraulics and Dynamics of New Corpus Christi Pass, Texas: A Case History, 1972-73," General Investigations of Tidal Inlets GITI 8. A038 472

Dahl, B. E., Cotter, P. C., Webster, D. B., and Drbal, D. D. 1983. "Posthurricane Survey of Experimental Dunes on Padre Island, Texas," Miscellaneous Report 8A-828 051

Dahl, B. E., and Goen, J. P. 1977. "Monitoring of Foredues on Padre Island, Texas," Miscellaneous Report 77-8. A043 875

Dahl, B. E., et al. 1975. "Construction and Stabilization of Coastal Foredues with Vegetation: Padre Island, Texas," Miscellaneous Paper 9-75. A018 065

Fields, L. M., Weishar, L. L., and Clausner, J. E. 1988. "Analysis of Sediment Transport in the Brazos River Diversion Channel Entrance Region," Miscellaneous Paper CERC-88-7. A193 979

Gage, B. O. 1970. "Experimental Dunes of the Texas Coast," Miscellaneous Paper 1-70. 702 902

Garcia, A. W., and Flor, T. H. 1984. "Hurricane Alicia Storm Surge and Wave Data," Technical Report CERC-84-6. A149 668

Kieslich, J. M. 1977. "A Case History of Port Mansfield Channel, Texas," General Investigations of Tidal Inlets GITI 12. A033 607

Mason, C., Grogg, W. E., Jr., and Wheeler, S. C. 1983. "Shoreline Erosion Study, Pleasure Island, Texas," Miscellaneous Paper CERC-83-8. A138 653

Mason, C. 1981. "Hydraulics and Stability of Five Texas Inlets," Miscellaneous Report 81-1. A101 843

Price, W. A. 1956. "Hurricanes Affecting the Coast of Texas from Galveston to Rio Grande," BEB Technical Memorandum TM 78. 115 551

Watson, R. L., and Behrens, E. W. 1976. "Hydraulics and Dynamics of New Corpus Christi Pass, Texas: A Case History, 1973-75," General Investigations of Tidal Inlets GITI 9. A033 607

Webb, J. W., and Dodd, J. D. 1976. "Vegetation Establishment and Shoreline Stabilization: Galveston Bay, Texas," Technical Paper 76-13. A030 169

Williams, S. J., Prins, D. A., and Meisburger, E. P. 1979. "Sediment Distribution Sand Resources, and Geologic Character of the Inner Continental Shelf Off Galveston County Texas," Miscellaneous Report 79-4. A074 393

C. Alaska and Pacific island

1. Alaska

Chu, Yen-Hsi, Gravens, M. B., Smith, J. M., Gorman, L. T., and Chen, H. S. 1987. "Beach Erosion Control Study, Homer Spit, Alaska," Miscellaneous Paper CERC-87-15. A187 016

Chu, Y., and Chen, H. S. 1985. "Bechevin Bay, Alaska, Inlet Stability Study," Miscellaneous Paper CERC-85-5. A157 494

Everts, C. H., and Moore, H. E. 1976. "Shoaling Rates and Related Data from Knik Arm Near Anchorage, Alaska," Technical Paper 76-1. A027 095

Smith, O. P., Smith, J. M., Cialone, M. A., Pope, J., and Walton, T. L. 1985. "Engineering Analysis of Beach Erosion at Homer Spit, Alaska," Miscellaneous Paper CERC-85-13. A162 940

Wilson, B. W., and Torum, A. 1968. "The Tsunami of the Alaskan Earthquake, 1964; Engineering Evaluation," Technical Memorandum TM 25. 684 491

2. Hawaii

3. Other Pacific islands

D. Mainland Pacific coast

1. Washington

2. Oregon

Herndon, H. D., Andrew, M. E., Hemsley, J. M., and Bottin, R. R., Jr. 1992. "Monitoring of Jetty Improvements at Umpqua River, Oregon," Miscellaneous Report CERC-92-1. A247 764

Higley, D. L., and Holton, R. L. 1981. "A Study of the Invertebrates and Fishes of Salt Marshes in Two Oregon Estuaries," Miscellaneous Report 81-5. A106 973

Howell, G. L., and Rhee, J. P. 1990. "Investigation of Seismic Wave Gage Analysis Techniques and Comparative Evaluation of the Seismic Wave Gage at Chetco River, Oregon," Miscellaneous Paper CERC-90-3. A221 548

Thompson, E. F., Howell, G. L., and Smith, J. M. 1985. "Evaluation of Seismometer Wave Gage and Comparative Analysis of Wave Data at Yaquina and Coquille Bays, Oregon," Miscellaneous Report CERC-85-12. A162 940

3. California

Bowen, A. J., and Inman, D. L. 1966. "Budget of Littoral Sands in the Vicinity of Point Arguello, California," Technical Memorandum TM 20. 647 214

Bruno, R. O., et al. 1981. "Longshore Sand Transport Study at Channel Islands Harbor, California," Technical Paper 81-2. A101 856

Caldwell, J. M. 1956. "Wave Action and Sand Movement Near Anaheim Bay, California," BEB Technical Memorandum TM 68. 115 104

Cherry, J. S. 1965. "Sand Movement Along a Portion of the Northern California Coast," Technical Memorandum TM 14. 628 866

Duane, D. B., and Judge, C. W. 1969. "Radioisotopic Sand Tracer Study, Point Conception, California," Miscellaneous Paper 2-69. 690 804

Hobson, R. D. 1982. "Performance of a Sand Trap Structure and Effects of Impounded Sediments, Channel Islands Harbor, California," Technical Report 82-4. A123 972

Hurd, J. 1974. "Hydraulic Method Used for Moving Sand at Hyperion Beach Erosion Project, El Segundo, California," Miscellaneous Paper 4-74. 785 552

Inman, D. L., and Rusnak, G. S. 1956. "Changes in Sand Level on the Beach and Shelf at La Jolla, California," BEB Technical Memorandum TM 82. 114 828

Johnson, G. F. 1978. "Ecological Effects of an Artificial Island, Rincon Island, Punta Gorda, California," Miscellaneous Report 78-3. A062 065

Johnson, J. W. 1974. "Bollinas Lagoon Inlet, California," Miscellaneous Paper 3-74. 785 747

- Judge, C. W. 1970. "Heavy Minerals in Beach and Stream Sediments as Indicators of Shore Processes Between Monterey and Los Angeles, California," Technical Memorandum TM 33. 717 034
- Kamel, A. M. 1962. "Littoral Studies Near San Francisco Using Tracer Techniques," BEB Technical Memorandum TM 131. 297 385
- Keith, J. M., and Skjei, R. E. 1974. "Engineering and Ecological Evaluation of Artificial-Island Design, Rincon Island, Punta Gorda, California," Technical Memorandum TM 43. 778 740
- Krumbein, W. C., and James, W. R. 1974. "Spatial and Temporal Variations in Geometric and Material Properties of a Natural Beach," Technical Memorandum TM 44. 785 572
- Lott, J. W. 1991. "Spud Point Marina Breakwater, Bodega Bay, Sonoma County, California," Miscellaneous Paper CERC-91-5. A240 319
- Morrison, J. R. 1953. "Areal and Seasonal Variations in Beach and Nearshore Sediments at La Jolla, California," BEB Technical Memorandum TM 39. 20 041
- Nordstrom, C. E., and Inman, D. L. 1975. "Sand Level Changes on Torrey Pines Beach, California," Miscellaneous Paper 11-75. A019 833
- Oliver, J. S., and Slattery, P. N. 1976. "Effects of Dredging and Disposal on Some Benthos at Monterey Bay, California," Technical Paper 76-15. A032 684
- Resio, D. T. 1987. "Extreme Runup Statistics on Natural Beaches," Miscellaneous Paper CERC-87-11. A182 709
- Savage, R. P. 1957. "Sand Bypassing at Port Hueneme, California," BEB Technical Memorandum TM 92. 132 765
- Schneider, C., and Weggel, J. R. 1982. "Littoral Environment Observation (LEO) Data Summaries, Northern California, 1968-78," Miscellaneous Report 82-6. A128 551
- Smith, O. P. 1983. "Reconnaissance Report on Coastal Erosion at Fort Ord, California," Miscellaneous Paper CERC-83-10. A137 419
- Tait, J. F., and Griggs, G. B. 1991. "Beach Response to the Presence of a Seawall; Comparison of Field Observations," Contract Report CERC-91-1. A 237 709
- Trask, P. D. 1954. "Bore Hole Studies of the Naturally Impounded Fill at Santa Barbara, California," BEB Technical Memorandum TM 49. 49 233
- Trask, P. D. 1955. "Movement of Sand Around Southern California promontories," BEB Technical Memorandum TM 76. 77 514
- Trask, P. D. 1956. "Changes in Configuration of Point Reyes Beach, California 1955-1956," BEB Technical Memorandum TM 91. 111 323
- Trask, P. D. 1959. "Beaches Near San Francisco, California 1956-1957," BEB Technical Memorandum TM 110. 216 771
- Trask, P. D., and Johnson, C. A. 1955. "Sand Variation at Point Reyes Beach, California," BEB Technical Memorandum TM 65. 115 101
- Weggel, J. R., and Clark, G. R. 1983. "Sediment Budget Calculations, Oceanside, California," Miscellaneous Paper CERC-83-7. A137 395
- Zeller, R. P. 1962. "A General Reconnaissance of Coastal Dunes of California," BEB Miscellaneous Paper 1-62. 699 905

E. Great Lakes and other lakes

1. Lake Superior

2. Lake Michigan

Birkemeier, W. A. 1980. "The Effect of Structures and Lake Level on Bluff and Shore Erosion in Berrien County, Michigan, 1970-74," Miscellaneous Report 80-2. A087 262

Birkemeier, W. A. 1981. "Coastal Changes, Eastern Lake Michigan, 1970-74," Miscellaneous Report 81-2. A097 985

Davis, R. A., Jr. 1976. "Coastal Changes, Eastern Lake Michigan, 1970-73," Technical Paper 76-16. A097 985

Davis, R. A., Jr., Fingleton, W. G., and Pritchett, P. C. 1975. "Beach Profile Changes: East Coast of Lake Michigan, 1970-72," Miscellaneous Paper 10-75.

A018 891

Hands, E. B. 1976. "Observations of Barred Coastal Profiles Under the Influence of Rising Water Levels, Eastern Lake Michigan, 1967-71," Technical Report 76-1.

A023 191

Hands, E. B. 1979. "Changes in Rates of Shore Retreat, Lake Michigan, 1967-76," Technical Report 79-4.

A081 863

Hands, E. B. 1980. "Prediction of Shore Retreat and Nearshore Profile Adjustments to Rising Water Levels on the Great Lakes," Technical Report 80-7.

A098 531

Hands, E. B. 1981. "Predicting Adjustments in Shore and Offshore Sand Profiles on the Great Lakes," Coastal Engineering Technical Aid CERC-81-4.

Hands, E. B. 1985. "The Great Lakes as a Test Model for Profile Response to Sea Level Changes," Miscellaneous Paper CERC-84-14.

A153 062

Hansen, M., and Underwood, S. G. 1991. "Coastal Response to the Port Sheldon Jetties at Pigeon Lake, Michigan," Miscellaneous Paper CERC-91-4.

A239 815

Meisburger, E. P., Williams, S. J., and Prins, D. A. 1979. "Sand Resources of Southeastern Lake Michigan," Miscellaneous Report 79-3.

A073 817

Morang, A. 1987. "Side-scan Sonar Investigation of Breakwaters at Calumet and Burns Harbors on Southern Lake Michigan," Miscellaneous Paper CERC-87-20.

A 189 415

3. Lake Huron

Horsham, G. M. 1985. "Wave Climatology Study for Ludington Harbor, Michigan," Miscellaneous Report 85-7.

A157 074

Nester, R. T., and Poe, T. P. 1982. "Effects of Beach Nourishment on the Nearshore Environment in Lake

Huron at Lexington Harbor (Michigan)," Miscellaneous Report 82-13.

A123 066

4. Lake Ontario

5. Lake Erie

Carter, C. H., Williams, S. J., Fuller, J. A., and Meisburger, E. P. 1982. "Regional Geology of the Southern Lake Erie (Ohio) Bottom: A Seismic Reflection and Vibracore Study," Miscellaneous Report 82-15.

A126 565

Gorechi, R. J., and Pope, J. 1993. "Coastal Geologic and Engineering History of Presque Isle Peninsula, Pennsylvania," Miscellaneous Paper CERC-93-8.

Hemsley, J. M., Bottin, R. R., Jr., and Mohr, M. C. 1991. "Monitoring of Completed Breakwaters at Cattaraugus Creek Harbor, New York," Miscellaneous Report CERC-91-10.

A242 086

Pope, J., Bottin, R. R., Jr., and Rowen, D. 1993. "Monitoring of East Breakwater Rehabilitation at Cleveland Harbor, Ohio," Miscellaneous Paper CERC-93-5.

Williams, S. J., Carter, C. H., Meisburger, E. P., and Fuller, J. A. 1980. "Sand Resources of Southern Lake Erie, Conneaut to Toledo, Ohio - a Seismic Reflection and Vibracore Study," Miscellaneous Report 80-10.

A097 984

Williams, S. J., and Meisburger, E. P. 1982. "Geological Character and Mineral Resources of South Central Lake Erie," Miscellaneous Report 82-9.

A123 085

6. Lakes and reservoirs

F. Indian Ocean

1. Oman

Everts, C. H., Garcia, A. W., and Meisburger, W. P. 1983. "Sedimentation Investigation at Masirah Island, Oman," Miscellaneous Paper CERC-83-6.

A137 142

Appendix H Field Reconnaissance for Coastal Change Study, Site Visit Checklist

Surveys - Profiles

- a. Profiles obtained using bank level and tape
- b. Two typical beach profiles - extending from low tide line to at least 30 m beyond the toe of bluff or extreme high-water mark
- c. Reference location of profiles to local survey monuments or prominent feature
- d. Date and time of tide line measurement
- e. Identify location of extreme high-water line
- f. Approximate dimensions of erosion or deposition area
- g. Photographs of beach where profiles are located

Sediments/Geology

- a. Visual classification of beach, bank, or bluff sediments
 - (1) Sandy beach - photos within 0.3 m
 - (2) Gravel beach - photos within 0.6 m
- b. Occurrence of permafrost, ice lenses, or other frozen ground features in the project area
- c. Location of bedrock, gravel, sand, etc.
- d. Structure and lithologies of bedrock
- e. Mineralogic/lithologic composition of beach material
- f. Geomorphic features - bedrock and sediment types

Wave Climate - Coastal Change Description (local records & sources)

- a. Erosion or deposition rate
- b. Time of year that maximum change occurs

- c. Direction and magnitude of significant storms
- d. Height, frequency, and period of storm-generated waves
- e. Photographs of the eroding or accreting area
- f. Possible causes of shoreline change
 - (1) Wave action
 - (2) Tidal action
 - (3) Storm surge
 - (4) Upland drainage
 - (5) Sloughing of bluff material
 - (6) Ice action
 - (7) Thermal degradation in permafrost areas
 - (8) Uses by people, such as boat wakes and upland traffic (foot or vehicle)

Real Estate Concerns

- a. Brief description and photographs of threatened representative structures
- b. Estimate value of land, structures, utilities which are considered threatened
- c. Identify potential land available for relocation
- d. Estimate value of land needed for relocation

Environmental Concerns

- a. Loss of habitat
 - (1) Fauna
 - (2) Flora
 - (3) Wetland
 - (4) Nesting areas
 - (5) Spawning areas

EM 1110-2-1810
31 Jan 95

b. Hazardous, Toxic, and Radioactive Waste
(HTRW) concerns

- (1) Via erosion
- (2) Via deposition

c. Archaeological concerns

- (1) Via erosion
- (2) Via deposition

Appendix I General Procedures for Conducting Offshore Sand Inventory Assessment Studies

General Process

The Coastal Engineering Research Center (CERC) has conducted numerous reconnaissance studies for the purpose of identifying potential borrow sites and has provided published guidance to Districts. The generally accepted procedure for conducting these types of investigations consists of a sequence of tasks:

a. Thorough review of existing technical literature from USACE sources, journals, state geological agencies, and universities.

b. Broad-scale reconnaissance geophysical surveys if necessary. Existing data may be substituted if the technical quality and the navigation control comply with present standards.

c. Vibracoring to identify reflectors or recover sediment from areas where acoustic penetration was limited. Cores should be spread throughout the survey area on a rectangular grid or in a pattern that crosses the prevailing trend of the offshore geology. This step can be skipped if cores from previous studies are available.

d. Detailed high-resolution seismic surveys of restricted areas that may be possible borrow sources. Survey tools may include:

- (1) Survey echosounder.
- (2) 3.5- or 7.0-Khz high-resolution profilers.
- (3) Sparker or boomer system for deeper penetration.
- (4) Side-scan sonar for identification of surface structure and hazards (debris, pipelines, shipwrecks).
- (5) Magnetometer to identify seafloor hazards and cultural resources.

e. Detailed vibracoring and surface grab sampling of the likely borrow sites, based on detailed seismic surveys.

f. Biological surveys and sampling when required by state and Federal regulations.

g. Design studies which compare the suitability of the potential borrow area sediments and economic and environmental comparative analysis to prioritize each potential site.

Seismic Surveys

a. It is generally most satisfactory to run seismic surveys in a pattern that is perpendicular to the prevailing offshore geologic structures or surficial topography. Existing scientific literature and bathymetric maps are available to help guide planning of the surveys. "Exploration and Sampling Methods for Borrow Areas" by Meisberger (1990) is a concise review of survey equipment and planning. This work also lists the reports completed for CERC's Inner Continental Shelf Sediments Study (ICONS) along the U.S. east coast and Lakes Erie and Michigan.

b. Along most coastlines, seismic lines are run perpendicular to the coast. For example, along southeast Florida, two or three reefs run parallel to the shore and project up from the seafloor. Between the reefs are accumulations of sand of varying thickness. Surveys run perpendicular to the shore can identify the extent of the sand accumulations and the areas of hard bottom.

c. If the prevailing offshore geology is not parallel to the shore, the survey lines should be adjusted to best image the terrain. For example, off Ocean City, Maryland, ridges extend from the shore in a northeast direction. In this area, Field (1979) ran survey lines in a grid at an angle to the shore allowing him to run both parallel and perpendicular to the ridges (Figure 1). Off Cape May, New Jersey, Meisberger and Williams (1980) ran lines in a rectangular grid and collected cores at selected intersection points.

d. For offshore areas where little is known about the surficial geology, an alternative procedure is to run survey lines in a zigzag pattern approximately perpendicular to the coast (Figure 2).

Interpretation of Seismic Data

The interpretation of profiler records is a skill developed over considerable time and with much practice. Sub-bottom profiles from muddy or silty bottoms are usually easy to interpret because the layering is typically

¹ See Appendix A, "References."

horizontal and discontinuities, such as sand-filled stream channels, are obvious. Records from sand and mixed bottoms, especially in formerly glaciated areas, are much more difficult to decipher. Meisberger (1990) discusses some fundamentals of profile interpretation, and Sieck and Self (1977) discuss interpretation in greater depth. Theory of signal propagation and data acquisition are reviewed in Sheriff and Geldart (1982).

Side-scan sonograms also require skill and experience to interpret, despite recent advances in digital signal

processing and image enhancement. Flemming (1976) reviews methods of sonogram interpretation.

The most satisfactory geophysical survey interpretations usually occur when the surveys are planned and conducted by a combination of geophysicists and coastal geologists with knowledge of the local geology and the project requirements. These same individuals should interpret the records and help select coring sites.

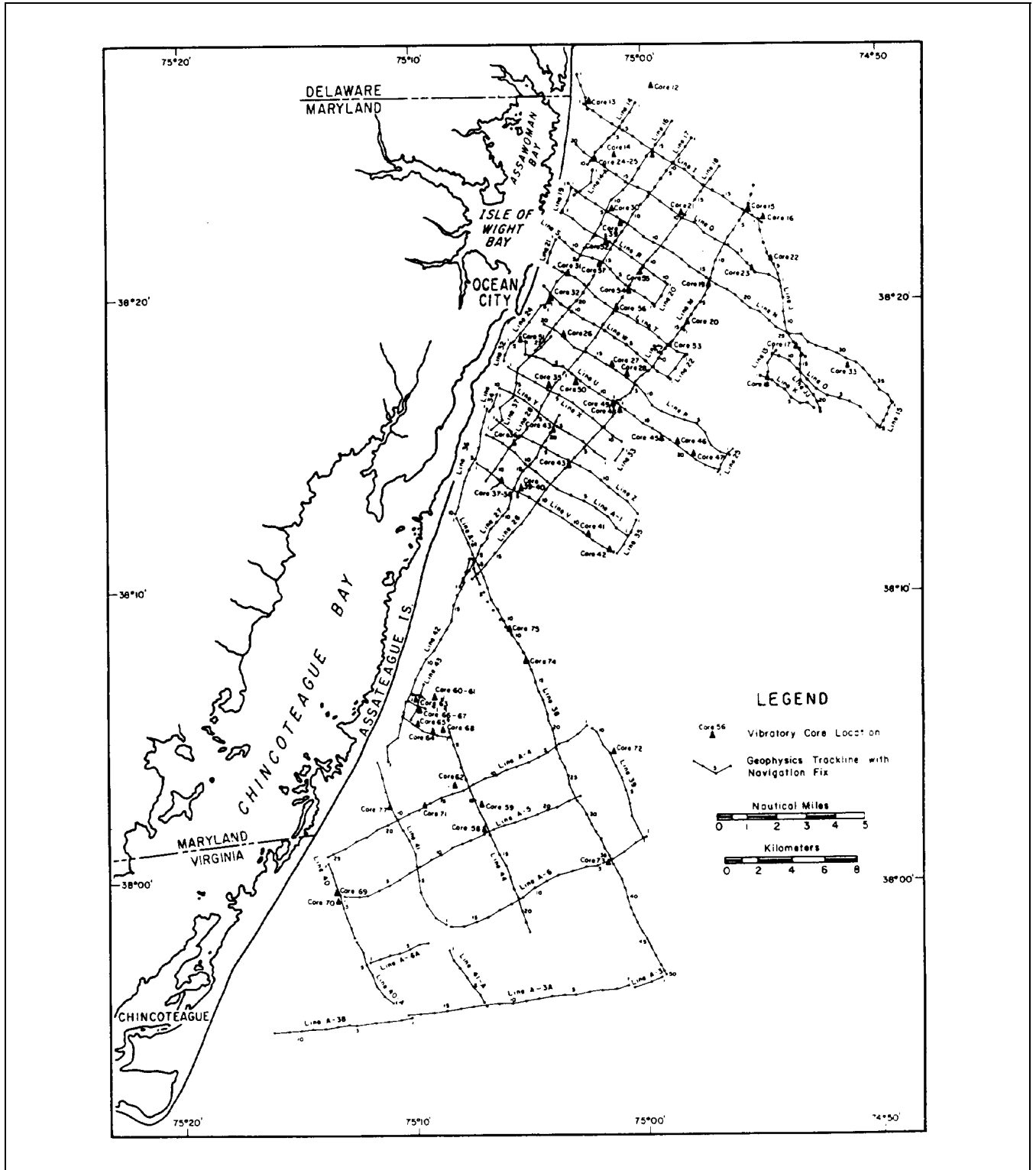

Figure I-1. Rectangle grid survey pattern used by Field (1979) off the Delmarva Peninsula

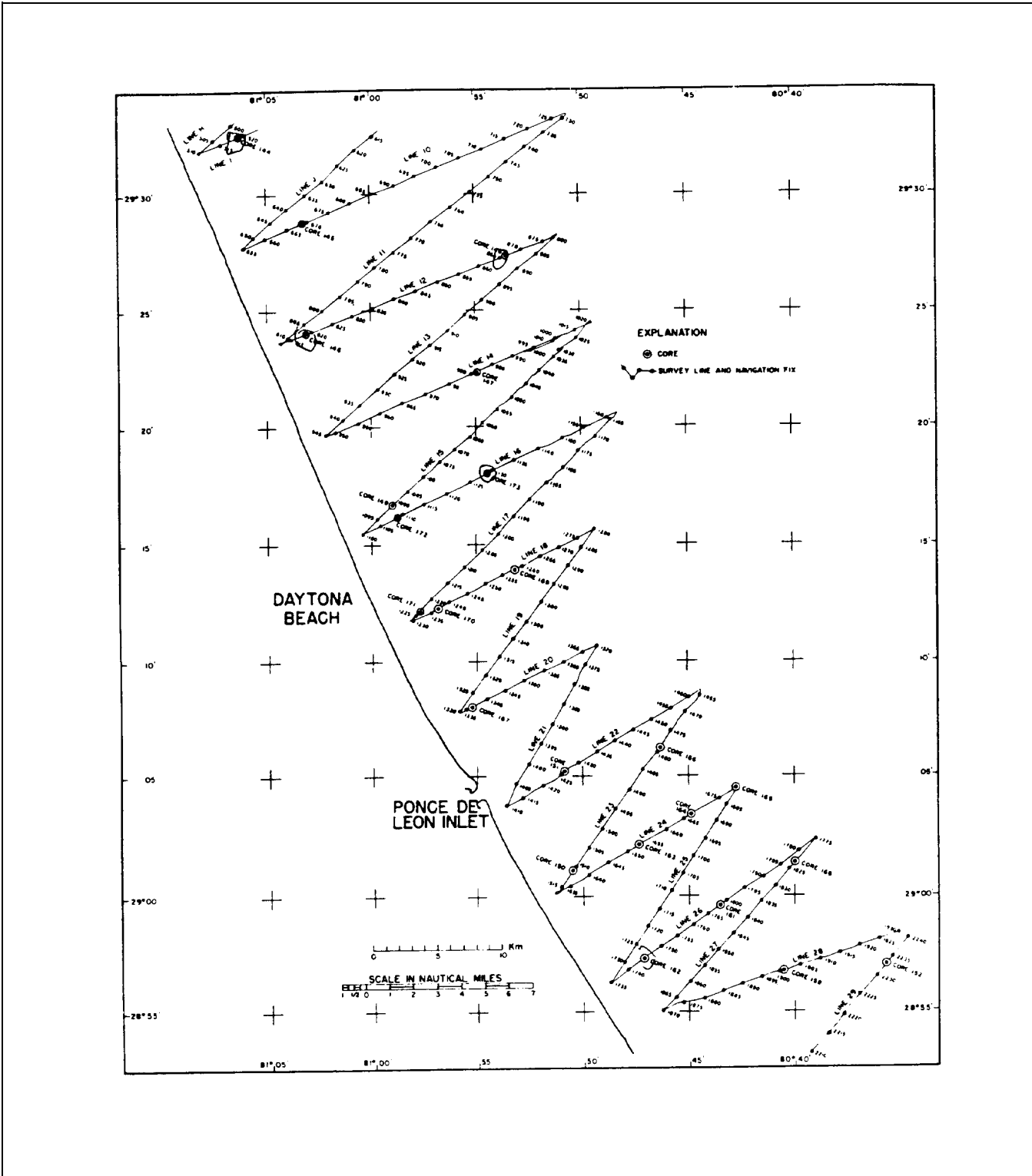

Figure I-2. Zigzag reconnaissance survey pattern from the Florida east coast (from Meisburger (1990))¹

¹ See references at end of main text.