



Online Continuing Education for Professional Engineers
Since 2009

Best Management Practices – Urban Stormwater Systems

PDH Credits:

5 PDH

Course No.:

BUS101

Publication Source:

South Florida Water Management District

**"Best Management Practices for South Florida
Urban Stormwater Management System"**

Pub. # REG-004

Release Date:

April 2002

DISCLAIMER:

All course materials available on this website are not to be construed as a representation or warranty on the part of Online-PDH, or other persons and/or organizations named herein. All course literature is for reference purposes only, and should not be used as a substitute for competent, professional engineering council. Use or application of any information herein, should be done so at the discretion of a licensed professional engineer in that given field of expertise. Any person(s) making use of this information, herein, does so at their own risk and assumes any and all liabilities arising therefrom.

Best Management Practices for South Florida Urban Stormwater Management Systems



April 2002

**South Florida Water Management District
3301 Gun Club Road
West Palm Beach, FL 33306
(561) 686-8800
www.sfwmd.gov**

Best Management Practices for South Florida Urban Stormwater Management Systems



April 2002

**South Florida Water Management District
3301 Gun Club Road
West Palm Beach, FL 33306
(561) 686-8800
www.sfwmd.gov**

TECHNICAL PUBLICATION REG-004
BEST MANAGEMENT PRACTICES
FOR
SOUTH FLORIDA
URBAN STORMWATER MANAGEMENT SYSTEMS

by
Vincent F. Peluso, P.E.
Ana Marshall

April 2002

Technical Editor
Kimberly Jacobs

Special Acknowledgements:

Paul McGinnes, Ph.D., P.E.

Damon Meiers, P.E.

Carlos Adoriso, P.E.

Julia Lacy, P.E.

William Donovan, Ph.D.

Barbara Powell

Margaret McPherson

Angela Farinelli

Everglades Stormwater Program
South Florida Water Management District
West Palm Beach, Florida

www.sfwmd.gov

TABLE OF CONTENTS

I.	Introduction	1
II.	Overview: Stormwater Management in Urban Areas	1
III.	Sources of Pollutants in Urban Stormwater Runoff.....	3
IV.	Constituents of Pollutants in Urban Stormwater Runoff	4
V.	Methods of Quantifying Pollutants in Urban Stormwater Runoff	7
VI.	Feasibility Screening for Urban BMP Selection.....	10
VII.	Nonstructural BMP Options.....	18
VIII.	Structural BMP Options	23
IX.	Opportunities for BMP Implementation	28
X.	Conclusions	31
XI.	References	31
	Appendix A. Typical Costs Associated with Structural BMPs	A-1
	Appendix B. Turf and Landscaping Best Management Practices	B-1
	Appendix C. Structural BMP Fact Sheets	C-1

I. INTRODUCTION

The South Florida Water Management District (District) has prepared this document to increase public awareness about the management of urban stormwater runoff and how best management practices (BMPs) can be used to improve water quality. The document provides a general overview of stormwater runoff, the sources affecting water quality, and what can be done to improve the quality of stormwater discharges. This document serves as an important educational tool designed to describe the various opportunities for improving water quality in urban areas of South Florida.

II. OVERVIEW: STORMWATER MANAGEMENT IN URBAN AREAS

Background

Rapid urbanization impacts natural flowways and affects water quality and quantity. As an area develops, undisturbed pervious surfaces become impervious due to the construction of parking lots, buildings, homes, streets, and other structures. This increase in impervious surfaces results in increased stormwater runoff, which is the water that flows over the land during and immediately after storm events. The increase in stormwater runoff disrupts the natural balance of physical, chemical, and biological processes. It causes pollution in natural systems and results in soil erosion that creates damage downstream. It reduces the infiltration of water into the ground. In addition, the increase in runoff discharging through existing drainage systems may cause flooding.

In the past, conveying water off-site in the shortest time possible was a standard measure for flood protection. Today, more emphasis is being placed on the environmental impacts and effects of drainage systems and urbanization in general. Communities have implemented management practices for the development and redevelopment of projects to ensure that peak stormwater discharge rates, volumes, and pollution loads leaving a site are minimized without compromising flood protection. This can be achieved through stormwater management plans that provide for surface water drainage, flood protection, erosion and sediment control, aesthetic enhancement, recreational opportunities, reuse of water resources, and the reduction of pollutants through BMPs.

Nonpoint Source Pollution

Much of the pollution in waterways is caused by “nonpoint source” pollution as opposed to “point source” pollution. Point source pollution, such as discharges from factories or other industrial facilities that discharge wastewater, is typically thought of as causing surface water pollution. Due to more stringent regulation of these point sources of pollution, their contribution to water pollution has greatly diminished. Now, nonpoint sources of pollution can sometimes contribute more pollution in comparison to point source pollution.

Nonpoint source pollution is described as stormwater pollution that results from the accumulation of contaminants from land surface, erosion of soils, debris, increased volumes of stormwater runoff, atmospheric deposition, suspended sediments, dissolved contaminants, and other anthropomorphic contaminants. It is sometimes difficult to differentiate between a nonpoint source and a collection of many smaller point sources.

Stormwater Best Management Practices

A stormwater BMP is a method or combination of methods found to be the most effective and feasible means of preventing or reducing the amount of pollution generated by nonpoint sources to a level compatible with water quality goals. Problem assessment, including technological, economic, and institutional considerations; examination of alternative practices; and appropriate public participation, are all considered before implementing BMP solutions. The following three principles apply in the improvement of water quality through BMPs:

- Prevention.....Avoiding the generation of pollutants
- Reduction.....Reducing or redirecting pollutants
- Treatment.....Capturing and treating pollutants

Methods for controlling pollutants in stormwater runoff can be categorized as nonstructural or structural practices. The two methods are often used together to control runoff in new developments, existing developments, and construction sites.

Nonstructural BMPs

Nonstructural BMPs are practices that improve water quality by reducing the accumulation and generation of potential pollutants at or near their source. They do not require construction of a facility, but instead provide for the development of pollution control programs that include prevention, education, and regulation. These can be classified as follows:

- Planning and regulatory tools
- Conservation, recycling and source controls
- Maintenance and operational procedures
- Educational and outreach programs

Structural BMPs

Structural BMPs involve building an engineered “facility” for controlling quantity and quality of urban runoff. These structures treat runoff at either the point of generation or the point of discharge to either the storm sewer system or receiving waters. Most require some level of routine maintenance. Structural BMPs can be categorized as retention systems, detention systems, or other systems.

Although the basic principles of managing stormwater remain the same, they should be uniquely adapted to the special requirements of each project. It should be understood that no one BMP can be the “cure all” for a particular project, but if several are used together in a linked fashion like cars in a train (a “BMP treatment train”), adverse effects of urban stormwater runoff can be reduced or alleviated.

A careful assessment of stormwater management conditions should be made before choosing a system of comprehensive BMPs. First, potential pollutant sources and high risk areas of pollution must be identified. Then, the magnitude of the problem must be evaluated by monitoring and analyzing runoff to determine the amount and type of pollutants in terms of concentration or load. Understanding the source, amount, and characteristics of pollutants in stormwater runoff is essential in applying a screening process for selecting appropriate BMPs. Additional stormwater management resources can be found at the District's web site: <http://www.sfwmd.gov>.

III. SOURCES OF POLLUTANTS IN URBAN STORMWATER RUNOFF

Common pollutants found in stormwater runoff come from the following major sources:

- **Construction Activities:** Although relatively short-term, soil erosion from exposed land during construction activities is a major source of suspended solids in stormwater runoff. While most of the pollution consists of turbidity from earthwork operations, hydrocarbons from extensive use of large machinery and vehicles are also a major concern. Due to the proliferation of construction activities at any given time, the implementation of short-term pollution prevention measures and BMPs is critical.
- **Agricultural Activities:** These operations, which include farming and nursery activities, as well as equestrian communities, are a major source of pollutants in the form of fertilizer, animal waste, and soil erosion from exposed areas.
- **Street Pavement:** As roads degrade, surface components become common constituents of urban runoff. The largest is the aggregate material itself. Also, smaller quantities of contaminants originate from the asphalt binder, fillers, and substances applied to the surface by daily traffic.
- **Motor Vehicles:** Vehicle use creates pollutants such as fuel, lubricants, tire particles, brake linings, dust, exhaust emissions, asbestos, and heavy metals that collect on roads and in parking lots. Other constituents, such as organics, nutrients, and suspended solids, can adhere to vehicle surfaces and then be washed onto roads by rain and splashing.

- **Atmospheric Deposition:** Atmospheric contaminants such as dust and particles from industrial processes, and dust emissions from planes, cars, and exposed land fall on the ground and become mobile in runoff during a storm event.
- **Vegetation:** Organic matter such as leaves, grass, and other plant materials fall or are placed in areas where they can be carried away by stormwater runoff. They can become a large contributor of organic and nutrient pollutants.
- **Land Surface:** The type of land cover and amount of vehicular and pedestrian traffic in a particular area have a direct impact on the amount and type of runoff generated.
- **Litter:** Various kinds of litter, such as food containers, packaging materials, and landscape vegetation, can float in runoff and prevent structural controls from operating properly. In addition, animal droppings have been shown to be a contributor of nutrient and bacterial contamination.
- **Chemicals:** Chemicals, such as fertilizers, insecticides, and herbicides used on agricultural fields, roadside areas, and yards, contaminate surface and ground waters.
- **Wastewater:** Contamination from wastewater may occur if septic tanks or sanitary sewer systems overflow during local flooding. Improper connections between sanitary sewers and stormwater drainage systems may result in discharge of laundry or sanitary waste to drainage canals.

IV. CONSTITUENTS OF POLLUTANTS IN URBAN STORMWATER RUNOFF

This section describes common pollutants found in urban stormwater runoff. Each pollutant has a specific adverse impact on the health of our waterways and environment. A summary of pollutants, sources, and their impacts is provided at the end of this section in **Table 1**.

Sediments

Sediments are solid materials originating mostly from disintegrating rock, eroding soil, and/or accumulated organic material deposited on the land surface. Suspended sediments contribute the largest mass of pollutants to surface waters and cause both short- and long-term impacts. Sediments clog waterways, smother bottom living aquatic organisms, and increase turbidity. These conditions are monitored by measuring settleable solids, total suspended solids, and turbidity.

Immediate adverse impacts include increased turbidity, reduced light penetration with decreased submerged aquatic vegetation (Chesapeake Bay Local Government Advisory Committee, 1988), and reduced prey capture for sight-feeding predators. Also, fish and aquatic invertebrate respiration is impaired, and reduced reproduction results in a decline of commercial and recreational fishing resources. Heavy sediment deposition in low-velocity surface water may result in smothered benthic communities/reef systems (Buck, 1991), increased sedimentation of waterways, changes in the composition of bottom substrate, and degradation of aesthetic value.

Chronic effects may occur where sediments rich in organic matter or clay are present. These enriched depositional sediments may present a continued risk to aquatic and benthic life, especially where the sediments are disturbed and resuspended.

Nutrients

Nitrogen and phosphorous are the principal nutrients of concern in urban stormwater. In excess, they increase primary biological productivity and may cause unwanted and uncontrolled growth of algae and undesirable aquatic weeds. Surface algal scum, water discoloration, and the release of toxins from sediment may also occur. The major sources of nutrients in stormwater are urban landscape runoff (fertilizers, detergents, and plant debris), atmospheric deposition, and improperly functioning septic tanks (Terrene Institute and USEPA, 1996).

Heavy Metals

Heavy metals originate from the operation of motor vehicles, direct fallout, industry, and degradation of highway materials. The most abundant heavy metals typically found in urban runoff are lead, cadmium, chromium, copper, mercury, and zinc. Lead, zinc, and copper account for approximately 90 percent of dissolved heavy metals (Harper, 1985). Except for copper and cadmium, the majority of metals are present in particulate form. These substances disrupt the reproduction of fish and shellfish. In addition, heavy metals accumulate in fish tissue, posing a threat to humans. Another human and environmental threat is the potential for ground water contamination.

Oxygen Demanding Substances

Numerous organic materials are decomposed by microorganisms, thereby creating a need for oxygen. Oxygen consumption during this process results in an oxygen deficit that can kill fish and other aquatic life forms. Data have shown that urban runoff with high concentrations of decaying organic matter can severely depress dissolved oxygen levels after storm events (USEPA, 1983). Proper levels of dissolved oxygen are critical to maintaining water quality and aquatic life. Oxygen demanding substances found in urban stormwater can be measured through biochemical oxygen demand, chemical oxygen demand, and total organic carbon.

Petroleum Hydrocarbons

Petroleum hydrocarbons are derived from oil products. They include oil and grease, the compounds benzene, toluene, ethyl benzene, and xylene, and a variety of polynuclear aromatic hydrocarbons. Some petroleum hydrocarbons are known to be toxic to aquatic life at low concentrations. Hydrocarbons have a high affinity for sediment, and they collect in bottom sediments where they may persist for long periods of time and result in adverse impacts on benthic communities. The source of most such pollutants found in urban runoff is parking lots and roadways, leaking storage tanks, vehicle emissions, and improper disposal of waste oil.

Pathogens

Urban runoff typically contains elevated levels of pathogenic organisms such as coliform bacteria and viruses. Pathogens contaminate surface and ground water preventing swimming in water bodies, drinking from certain water sources, and harvesting of fish. This problem may be especially prevalent in areas with porous or sandy soils. The Terrene Institute and the United States Environmental Protection Agency (USEPA) (1996) reported that the primary sources of pathogens in urban runoff are animal wastes (including pets and birds), failing septic systems, illicit sewage connections, and boats and marinas.

Toxics

Many different toxic compounds (priority pollutants) have been associated with urban runoff. National urban runoff pollutant studies indicated that at least 10 percent of urban runoff samples contained toxic pollutants (USEPA, 1983). Synthetic organic compounds that are toxic include a variety of manufactured compounds covering pesticides, solvents, and household and industrial chemicals.

In sufficiently high concentrations, detergents and similar synthetic organic surfactants can interfere with the respiration of fish and other aquatic animals. The presence of detergents indicates there are either improper discharges into the stormwater collection system or that wastewater is entering through overflowing sanitary sewers or septic tanks. Detergents also indicate that loads of nutrients in stormwater may be significant as water conditioning chemicals are generally phosphate-based.

Others

Impacts not related to specific pollutants can also occur. These impacts can be caused by changes in the temperature or physical properties of the water. Changes in water temperature affect some important physical properties and characteristics of water, such as specific conductivity and conductance, salinity, and the solubility of dissolved gases. Water holds less oxygen as it becomes warmer resulting in less oxygen available for respiration by aquatic organisms. Higher temperatures also increase the metabolism, respiration, and oxygen demand of fish and other aquatic life. Water temperature changes

can result from increased flows, the removal of vegetative cover, and increased amounts of impervious surfaces. Alkalinity, dissolved oxygen, pH, hardness, and conductivity can also affect the behavior of materials in water. Metals generally become more soluble as pH drops below neutral and hence become more available to harm organisms (bioavailable). Depleted dissolved oxygen can also make some metals more soluble.

Table 1. Pollutants in Stormwater Runoff

Pollutant	Source	Impact to Water Body
Sediments	Eroding rock, soil, or organic material from building sites, streets, and lawns	Clogged waterways, increased turbidity, and reduction of bottom living organisms
Nutrients	Nitrogen and phosphorous from landscape runoff, atmospheric deposition, and faulty septic tanks	Unwanted growth of algae and undesirable aquatic weeds, scum, and water discoloration
Heavy Metals	Lead, cadmium, chromium, copper, mercury, and zinc from vehicles, highway materials, atmospheric deposition, and industry	Disruption of fish reproduction, fish toxicity, and potential for ground water contamination
Oxygen Demanding Substances	Decaying organic matter	Death of fish and aquatic life forms
Petroleum Hydrocarbons	Oil, grease, and various hydrocarbons from roads, parking lots, leaking storage tanks, and improper oil disposal	Toxicity to aquatic life and adverse impacts on benthic communities
Pathogens	Coliform bacteria and viruses from animal waste, septic systems, sewer cross-connections, and boats and marinas	Contamination of swimming, fishing areas, or drinking water
Toxics	Pesticides, solvents, and chemicals from lawns, gardens, and commercial and household activities	Interference with respiration of fish and aquatic life forms
Others	Changes in the temperature or physical properties of water	Increased oxygen demand by fish and aquatic life forms and increased availability of toxic elements that harm organisms

V. METHODS OF QUANTIFYING POLLUTANTS IN URBAN STORMWATER RUNOFF

Water pollutants can be quantified in terms of concentration or load. Concentration provides a method for comparing different storm events and relating one site with another. Loads are used to make relative comparisons of the same site and predict potential impacts and pollutant attenuation capabilities of various stormwater management practices.

Concentration

Concentration is the mass of pollutant per unit volume of water sample taken at a particular point in time. It is a static test to measure pollutant content. The amount of pollutant transported by runoff has been shown to vary considerably during each storm event as well as from site to site. A given site may produce different pollutant concentrations due to variability of rainfall intensity, frequency of the rain events, soil types, land uses, weather patterns, and intensity of watershed activities (Harper, 1999). Concentrations are usually expressed as milligrams per liter (mg/l).

Because of the difficulty in characterizing pollutant concentrations during dynamic flow conditions, the accepted practice is to determine an event mean concentration. This value is found by analyzing a single sample composited from a series of samples taken at different points in time throughout the runoff event and combined in proportion to the flow rate at the time of sampling, or by calculating the total pollutant mass discharged divided by the total discharge volume. Event mean concentration is generally accepted as the primary estimation of a characteristic pollutant concentration for individual storm events. This provides a method for comparing different storm events and relating one site with another. A good deal of research has been conducted showing the link between land use and water quality. **Table 2** shows national data for median event mean concentrations by land use category.

The interrelationships of rainfall runoff and soil erosion processes are dynamic and complex. Through research and a sound understanding of hydrologic processes, simple assumptions can be made to produce reasonable and practical runoff and soil erosion estimates. **Figure 1** shows typical pollutant concentrations in stormwater runoff throughout a storm event. Most pollutants are flushed at the beginning of a storm event. Runoff then accumulates slowly and peaks over time.

Table 2. Median Event Mean Concentrations by Land Use Category^a

Pollutant	Units	Residential	Mixed	Commercial	Open/ Nonurban
Soluble Phosphorus	µg/l ^b	143	56	80	26
Total Phosphorus	µg/l	383	263	201	121
Nitrate-Nitrite	µg/l	736	558	572	543
Total Kjeldahl Nitrogen	µg/l	1,900	1,288	1,179	965
Total Nitrogen	µg/l	2,636	1,846	1,751	1,508
Biochemical Oxygen Demand	mg/l	10.0	7.8	9.3	--
Chemical Oxygen Demand	mg/l	73	65	57	40
Total Suspended Solids	mg/l	101	67	69	70
Total Copper	µg/l	33	27	29	--
Total Lead	µg/l	144	114	104	30
Total Zinc	µg/l	135	154	226	195

a. Source: USEPA, 1983

b. µg/l - micrograms per liter

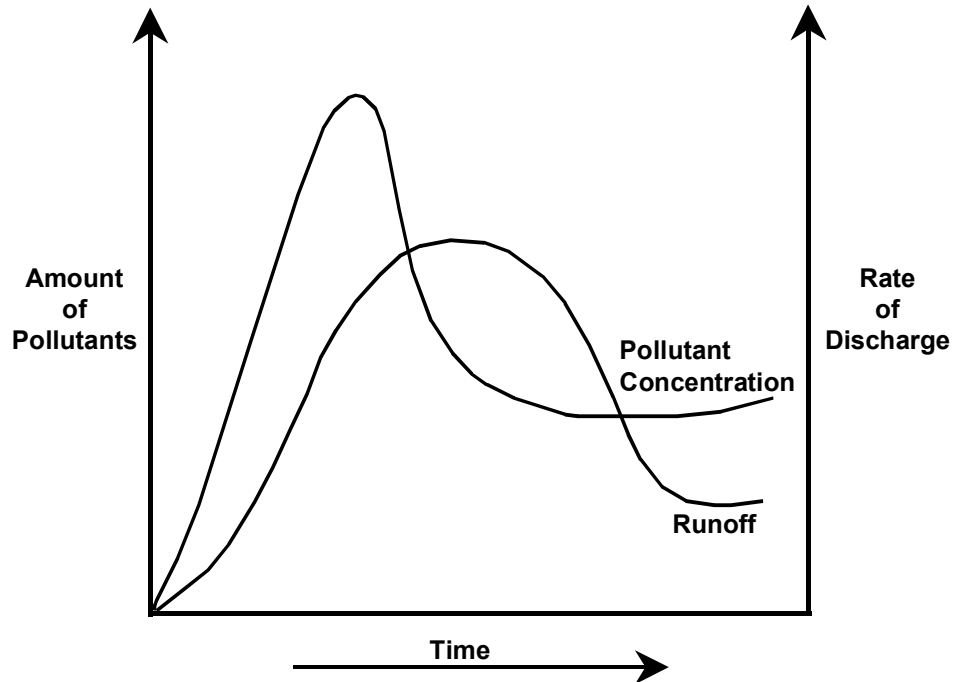

Figure 1. Pollutant Concentration during a Storm Event

Load

Load is the mass of pollutant delivered to a receiving water body during a period of time. It associates concentrations of a pollutant to a volume of runoff at a given specific flow duration. Loads are usually expressed on an annual basis as kilograms per year, and are used to make relative comparisons of the same site.

Evaluating pollutant loads on a mass basis provides further insight of potential impacts than might be obtained from evaluating concentration data only. Knowledge of mass loading rates also provides an understanding of pollutant attenuation capabilities of various stormwater management practices. Estimating cumulative (usually annual) pollutant loads for a watershed can be achieved by using the following types of data:

- Published yield values
- Simple empirical models
- Published regression equations
- Computations from site-specific or modeled flow data and either local or published concentrations
- Computer generated, mechanistic models

Many studies have documented a general order of loading from urban land uses. This order, from highest to lowest, is as follows, industrial and commercial, freeway, higher density residential, lower density residential, and open land. However, construction phases can produce far higher loads of solids and pollutants in soil, like phosphorous, than in any finished land use.

VI. FEASIBILITY SCREENING FOR URBAN BMP SELECTION

Selecting appropriate BMPs is an intricate process requiring thorough study and research. Success will ultimately depend on choosing feasible options that specifically address project conditions and objectives. A comprehensive management program should include a combination of structural and nonstructural components that are properly selected, designed, implemented, inspected, and regularly maintained. Whether implementing BMPs to meet regulatory requirements, address water quality issues in a watershed, or attack acute local pollution problems, the project should be evaluated for the following factors through a feasibility screening process:

- Physical and technical limitations
- Pollutant reduction capabilities
- Cost considerations
- Supplemental benefits/side effects
- Public acceptance

Physical and Technical Limitations

Watershed Area. The size of the area generating and/or contributing to stormwater runoff must be considered. Dry retention, exfiltration, concrete grid pavers, and filter BMPs generally are more suitable for smaller areas. Pond BMPs typically require a larger drainage area to assure proper operation.

Area Required for the BMP Option. Many BMPs are land intensive so adequate area must be available at the site for construction. Underground installations of certain BMPs can be costly maintenance items.

Pollutant Type and Loading. Most BMPs are effective at removing particulate-related pollutants. Some BMPs, primarily those with vegetative components, can also reduce dissolved constituents. Many are susceptible to clogging. Pretreatment can increase effectiveness, reduce maintenance, and extend the life of BMPs.

Soil Type. The permeability of soil has a direct influence on effectiveness, especially for retention practices. Soils such as silt and clay can influence the settling capabilities of BMPs.

Slope and Flow Characteristics. Water ponding or flow velocities may cause instability or erosion of sediment, which will eliminate some BMP options.

Water Table Elevation. For retention and dry detention systems, effectiveness and maintenance costs can be related to how close the bottom of the BMP is to the water table.

Bedrock or Hardpan. Restrictive soil layers or rock can impede downward infiltration of runoff or make excavation for ponds impossible or expensive.

Location. BMPs should not be located close to building foundations, septic tanks, or drinking wells. Seepage problems or ground water pollution can result from retention BMPs.

Receiving Waters. Receiving waters such as lagoons and estuaries would generally benefit from reductions in total volumes of runoff. However, normal timing and flow volumes into saline habitats must be considered as an appropriate freshwater-saltwater mix is needed to support these environments.

Figure 2 shows a generalized diagram to assist in determining potential BMP options to remove pollutants under specified site conditions. Special conditions may dictate the selection of alternative BMP options. For example, in an area with a high water table, an extended detention basin may not be feasible because basin excavation would be required.

Pollutant Reduction Capabilities

Interrelated factors generally govern pollutant removal capabilities achieved by BMPs. These factors include removal mechanisms in operation, type of contaminant to be removed, characteristics of the annual runoff volume directed to treatment, and BMP efficiency factors.

Removal Mechanisms

Removal of pollutants in stormwater can occur through sedimentation, flotation, filtration, infiltration, adsorption, biological uptake, biological conversion, and degradation. Most removal processes affect both particulate and dissolved forms of pollutants. Some removal mechanisms are more effective than others for specific pollutants.

Type of Contaminant to be Removed

Sediments

Settling is the most effective removal method for suspended solids. Settleability of a pollutant depends directly on particle size and density. Some suspended particles may not be settleable without the help of a coagulating agent. In describing settling characteristics of suspended solids, the following factors are of significance:

- Loading
- Percent settleable
- Particle size distribution
- Particle settling velocities
- Density of settleable pollutant
- pH of the water
- Heavy metal content of the water

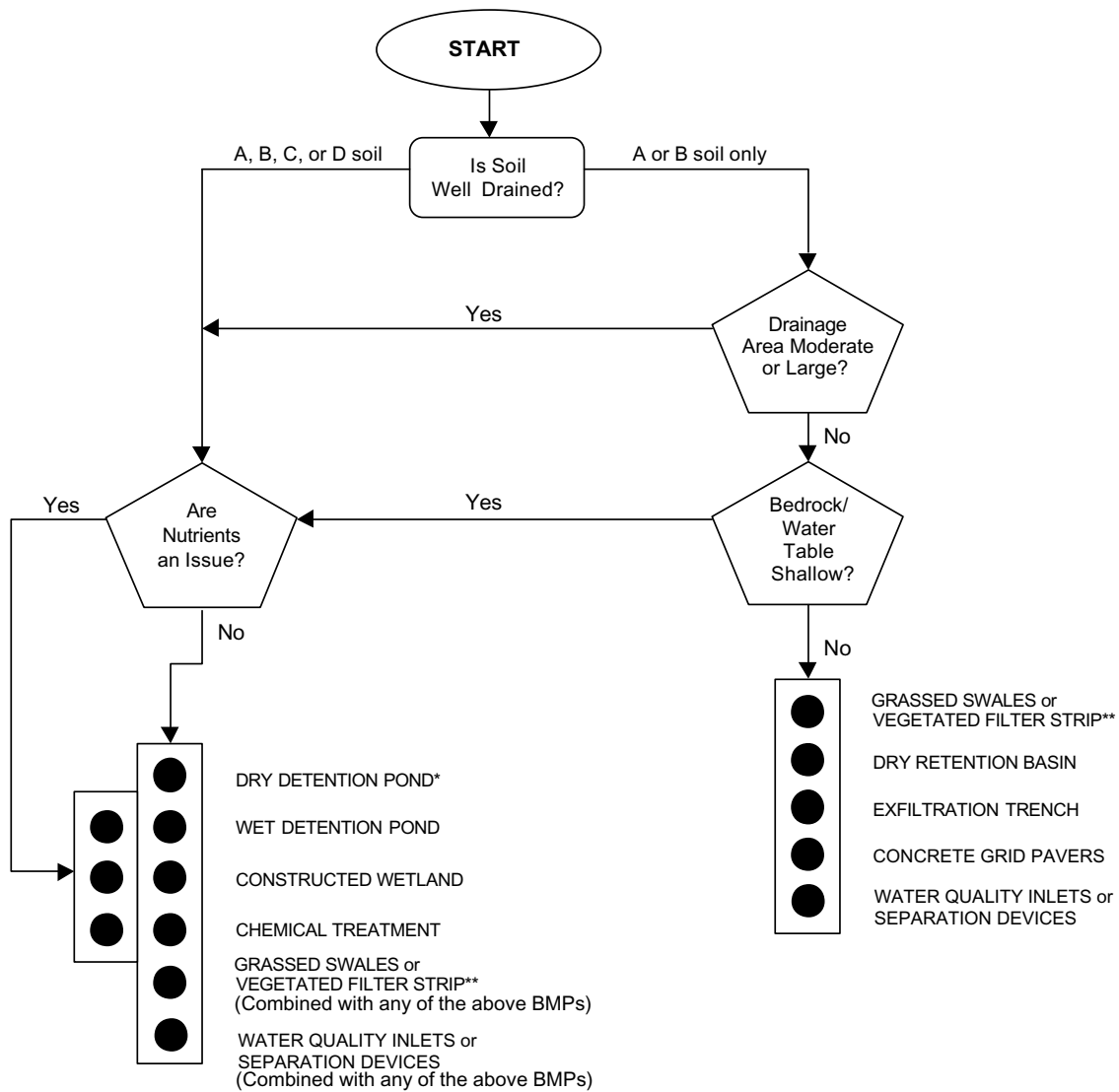

SOIL TYPES BASED ON SOIL CONSERVATION SERVICE CLASSIFICATION

- A: Sand, Loamy Sand
- B: Sandy Loam, Loam
- C: Silt Loam, Sand, Clay Loam
- D: Clay Loam, Silty Clay Loam, Sandy Clay, Silty Clay, Clay

* Option may not be feasible if excavation is required in areas with high water tables.

** Options can only be used when slopes along the flow path are moderately low.

Adapted from Camp et al., 1993

Figure 2. BMP Options for Specified Site Conditions

Based on a distribution of particle settling velocities from an urban runoff study conducted by the USEPA in 1986, approximately 20 percent of solids exhibit settling velocities less than 10^{-3} centimeters per second (cm/s), corresponding roughly to particle sizes less than 10 microns. Under ideal conditions, a particle settling at a 10^{-3} cm/s will travel approximately 5.7 feet in 48 hours and should be effectively removed from a water column of this approximate depth over a period of 48 hours. Particle sizes less than 10 microns, generally considered to be in the colloidal or clay range, cannot be effectively removed by settling (Harper, 1999).

Other studies associated with total suspended solids, chemical oxygen demand, total phosphorus, and lead that were conducted under laboratory conditions by Randall et al. (1982) indicate that settling processes for these pollutants appear to be virtually complete after 24 to 48 hours. Another study found that removal of dissolved ions by sedimentation was generally poor (Harper, 1999).

Nutrients

Nutrients may be in either dissolved or particulate form. Approximately 60 percent are present in particulate form. Removal of dissolved pollutants is generally optimized through biologically-mediated processes in systems that maintain permanent pools, have diverse flora and fauna, and are well oxygenated. The design of BMPs for removing nutrients should include provisions for settling nutrients in particulate form and also a nutrient assimilation component for dissolved forms, such as littoral zones within a detention system. Swale conveyance, sediment sumps, or a perimeter swale and berm system are also effective in reducing particulate nutrients. More specifically, phosphorous can be controlled by high soil exchangeable aluminum and/or iron content and by the addition of precipitating agents. Nitrogen can be controlled by alternating aerobic and anaerobic conditions, low toxicants, and neutral pH.

Heavy Metals

Dissolved heavy metals are removed from runoff primarily by physical and chemical processes (Harper, 1999). Processes include chemical precipitation, adsorption, sorption and coprecipitation, and complexation followed by coagulation and flocculation.

To maximize removal of heavy metals in detention BMPs, flow velocities should be gradually reduced and flow length from inlet to discharge point should be maximized to promote settling. Suitable vegetation should be planted to promote removal of dissolved metals. To remain aerobic and keep metals bound to sediments, it is important to keep the pH of the water around 7 so that metal-sediment associations are inert with minor tendencies for release into the water column. In addition, a high organic soil content with high soil cation exchange capacity is effective in treating metals.

Oxygen Demanding Substances

Removal of oxygen demanding wastes occurs through oxidation of organic matter by aerobic bacteria and fungi. This process is generally complete in 3 to 5 days (Harper,

1998). To effectively reduce this pollutant, systems must provide adequate supplies of oxygen and sufficient detention time for decomposition processes to occur. This can be accomplished with BMPs having shallow water depths (less than 10 to 15 feet), having a high length to width ratio so as to include wind mixing, or using artificial aerators.

Oils, Greases, and Hydrocarbons

These pollutants are removed primarily by physical and chemical processes. Low boiling hydrocarbons often float on the water surface and can be removed by vaporization. Greases generally accumulate into the sediments where they may undergo gradual microbial decomposition. Many pesticides are insoluble in water and readily adsorb onto soil particles. Oils and greases can be retained in BMPs utilizing skimmers at the discharge structure. Many drop-in filtration systems incorporate an oil and grease or hydrocarbon trap with a submerged outlet pipe that allows these contaminants to accumulate and be periodically removed.

Pathogens

Pathogens die off naturally, but the process can be promoted by plant excretions. Removal mechanisms include coagulation, predation by zooplankton, and adsorption onto suspended matter and sediments.

Characteristics of the Annual Runoff Volume Directed to Treatment

Rainfall characteristics such as average rainfall frequency, duration, and intensity must be reviewed before designing a BMP. These will directly affect the volume of water that needs to be detained, retained, or reused; the time needed to recover the treatment volume; and the process used to capture, filter, or assimilate pollutants. Pollutant control methods generally rely on capturing and treating runoff from small, frequent events that carry the majority of pollutants and the first flush of larger rainfall events (**Figure 1**). For example, in Florida, nearly 90 percent of a year's storm events produce one inch of rainfall or less and 75 percent of the total volume of rain falls in storms of one inch or less (Wanielista, 1977). In general, BMPs should be designed to provide treatment control for the smaller rain events rather than for extreme events.

Time is also a factor to consider in designing pollutant removal BMPs. Increasing the hydraulic residence time and promoting low turbulence will help achieve any objective in treating stormwater. The effectiveness of settling a solid particle is directly related to the time provided for sedimentation and determines the degree to which chemical and biological processes can occur. Water residence time is the most basic variable to apply effective treatment practice technology.

While specific structural design specifications and criteria for BMPs are not within the scope of this document, several publications are available to assist with BMP design. **Table A-1, Appendix A** provides information related to each BMP type.

Treatment Efficiency Factors

A goal of 80 percent annual reduction of stormwater pollutant loadings by stormwater management systems can be best achieved through a multilevel strategy that 1) prevents pollutants from entering the system, 2) considers operational and maintenance changes, 3) applies source controls and then treatment controls, and 4) administers communitywide prevention controls, where required.

Different BMPs have different effectiveness on different pollutants as shown in **Figure 3**. Removal efficiencies will vary based on the incoming concentrations of pollutants. High removal rates may be seen at higher initial concentrations, but when lower initial contaminant levels are put into the system it may be less effective and the percentage removal may be lower. Each control measure should provide sufficient pollutant control to warrant its inclusion. An average annual pollutant removal efficiency can be calculated based on the annual mass of pollutants introduced and the annual mass removed.

Urban runoff treatment systems are designed to capture and retain pollutants, especially solids. The accumulation of these materials can seriously impair the operation of a system and greatly reduce its effectiveness, resulting in pollutant discharge and possibly increased flooding. When selecting a BMP, appropriate operation, maintenance, and management considerations must be included in the decisionmaking process. In addition, responsibility for such items should be clearly assigned for the life of the system. See **Appendix A, Table A-1**, for more information related to each BMP type.

Cost Considerations

Construction of a proposed BMP in a selected location should require reasonable effort and expense. Required materials must be available and construction techniques feasible. The cost of BMP implementation should not exceed expected pollution control benefits, and the funding assessment should cover all stages of the BMP life. When computing implementation costs, the following factors should be evaluated during the selection process:

- Design and permitting costs
- Capital costs
- Operation, inspection, and maintenance costs
- Unit costs of pollutant removal

Design and permitting costs are generally estimated to be 25 to 35 percent of the base construction cost, depending on the geographic area and the experience of the designer (USEPA, 1999). Capital costs for installation and construction of structural BMPs vary nationwide depending on land costs, weather patterns, construction methods, and site specific conditions. Representative cost data for BMP installation or construction, operation, inspection, and maintenance have been summarized in **Appendix A**. The information was gathered from nationwide databases and should be used only as a

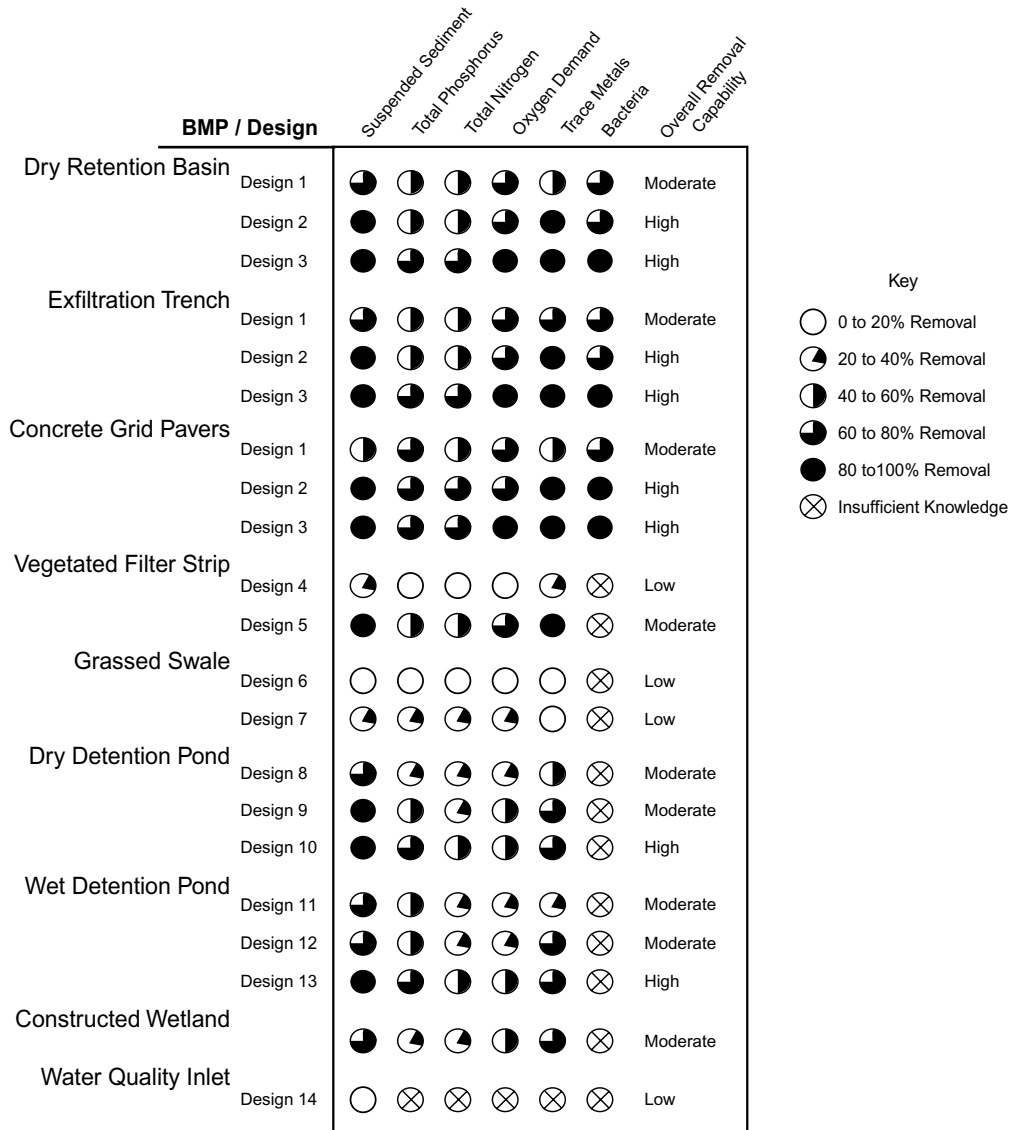

- Design 1** Facility exfiltrates first-flush runoff; 0.5-inch runoff per impervious acre
- Design 2** Facility exfiltrates 1-inch runoff volume per impervious acre
- Design 3** Facility exfiltrates all runoff, up to the 2-year design storm
- Design 4** 20-foot wide turf strip
- Design 5** 100-foot wide forested strip with level spreader
- Design 6** High slope swales with no check dams
- Design 7** Low gradient swales with check dams
- Design 8** First-flush runoff volume detained for 6 to 12 hours
- Design 9** Runoff volume produced by 1.0 inch, detained 24 hours
- Design 10** As in Design 9, but with shallow marsh in bottom stage
- Design 11** Permanent pool equal to 0.5-inch storage per impervious acre
- Design 12** Permanent pool equal to 2.5 (Vr) ; where Vr = mean storm runoff
- Design 13** Permanent pool equal to 4.0 (Vr) ; approximately 2 weeks retention
- Design 14** 400-cubic feet wet storage per impervious acre

(Adapted from Schueler 1987)

Figure 3. Pollutant Removal Effectiveness of Different BMPs

guideline. Since operation, inspection, and maintenance are crucial elements in maintaining BMP design integrity, a relative cost of these elements estimated as a percent of the capital cost has been included in **Appendix A**.

One way to design cost-effective BMPs is to relate basin volume to cost. Although, for most detention BMPs, a critical point occurs where little increase in percent runoff captured occurs with increase in basin volume.

Effects on stormwater quality from nonstructural BMPs are difficult to quantify and measure accurately without long-term data. Therefore, cost avoidance resulting from good management practices cannot be easily determined. In cases of recycling, the materials collected can serve as an indirect measure of overall success of the project. For water conservation measures, projected values can be compared to actual usage data to evaluate the program.

Supplemental Benefits and Side Effects

Both supplemental benefits and side effects can result from implementing BMPs and need to be considered when determining the appropriateness of a BMP. Supplemental benefits include opportunities for wildlife use, passive recreation, and water conservation. Side effects include the potential for mosquito breeding, downstream temperature changes, reduced base flows, and ground water contamination.

Public Acceptance

The more publicly accepted the BMP, the better chance it has for success. This is crucial when referring to nonstructural BMPs where a change in cultural practices is necessary. Structural BMPs require that the owner/operator be comfortable with project requirements before construction begins. A structural BMP will not perform as designed if it is not maintained properly. Therefore, a long-term commitment is needed.

Community involvement should be promoted to support pollution control initiatives. Active participation can be encouraged by defining problems clearly and outlining measures to solve them. A BMP program should incorporate the following guidelines:

- Reflect the characteristics of the community
- Acknowledge community priorities
- Heighten awareness about the program/problem
- Provide clear, concise information
- Explain what each individual must do
- Give the individual an easy way to do the task
- Monitor the program and gain feedback

VII. NONSTRUCTURAL BMP OPTIONS

Most nonstructural BMP options are applicable for use in residential, commercial, industrial, agricultural, and nursery operations in newly developed or existing watersheds. They can be used to complement structural BMPs in developing areas, but may be the only option in existing developments. These options are based on changes in human practices that result in the *prevention or reduction* of the generation of contaminants into stormwater runoff. Because they rely on actions and not structures, they must be implemented consistently and repetitively over time. Any process for selecting nonstructural BMPs should take into consideration the incorporation of the following elements: planning and regulatory tools; conservation, recycling, and source controls; maintenance and operational procedures; and educational and outreach programs.

Planning and Regulatory Tools

Action plans and regulations encourage or mandate management practices that prevent, reduce, or treat stormwater runoff. For example, setbacks can be required from waterways, minimum allowable impervious areas within a site can be established, and criteria for treating runoff can be mandated. Plans for stormwater runoff control should be submitted to the appropriate agencies for review and approval. The planning process gives the public an opportunity to participate in the decisionmaking process regarding stormwater quality for existing and future land uses within their area. Existing federal, state, local, and site specific requirements provide the basis for building regulatory programs.

Ordinances and Regulatory Programs

Federal agencies are tasked with establishing nationwide programs to address stormwater pollution. The State of Florida has generally established regulations by adopting the appropriate Code of Federal Regulations title into the Florida Statutes and the Florida Administrative Code. Water management districts function under these codes and require permits for the construction and operation of water management systems, water usage, or water quality monitoring plans.

Local governments play an important role in establishing regulatory programs that provide opportunities to meet specific local objectives. Regulatory measures must comply with state and federal mandates and should address such issues as hazardous materials codes, zoning, land development and land use regulations, water shortage and conservation policies, and controls on types of flow allowed to drain into sanitary municipal storm sewer systems. For a successful local program the following elements should be considered:

- Community/business composition
- Land use patterns
- Local practices
- Community concerns
- Institutional characteristics

Ordinances are laws or rules issued by a local government under legal authority granted by statutes. They can include findings of fact, objectives or purposes, definitions, permitting requirements, variances, performance/design standards, and enforcement policies. For further information and samples of ordinances, refer to Chapter 8 of the Florida Department of Environmental Protection's *Florida Development Manual - A Guide to Sound Land and Water Management* (FDER, 1992).

Low Impact Development

In low impact development, stormwater is managed in small, cost-effective landscape features located on each land parcel rather than being conveyed to large, costly, pond facilities located at the bottom of drainage areas. The concept of source control is quite different from end of pipe treatment. Hydrologic functions such as filtration, frequency, and volume of discharges, and ground water recharge can be maintained by reducing impervious surfaces, functional grading, open channel sections, reuse of runoff, and using multifunctional landscape features such as rain gardens, swales, mulch, and conservation areas.

Conservation, Recycling, and Source Controls

Conservation Plan

All water users, including domestic, utility, commercial, agricultural, and recreational, have an opportunity and responsibility to conserve water to reduce or eliminate the amount of water potentially requiring stormwater runoff treatment. Promotion of conservation practices is essential in all communities. A good water conservation plan should include a framework for the following components:

- Appropriate lawn irrigation
- Adoption of Xeriscape® landscape ordinances
- Installation of ultra-low volume plumbing fixtures in new construction
- Adoption of conservation-oriented rate structures by utilities
- Implementation of leak detection programs by utilities with unaccounted for water loss greater than 10 percent
- Institution of public education programs for water conservation

Using Reclaimed Water

Recycling water involves treating and disinfecting wastewater and using the reclaimed water for new, beneficial uses such as the following:

- Landscape irrigation for parks, golf courses, highway medians, and residential lawns
- Agricultural irrigation for crops, pasture lands, and nursery operations

- Ground water recharging either directly or through rapid infiltration basins
- Industrial cooling or in-manufacturing processes
- Creating or restoring wetlands
- Fire protection
- Separate toilet piping systems in industrial or commercial buildings
- Aesthetic enhancements for ponds, fountains, and landscape features
- Dust control for construction sites or unpaved road communities

Source Control Measures

These measures address disposal practices of contaminants on the typical urban landscape. They may reduce or eliminate pollutants deposited on land surfaces that may eventually come in contact with stormwater and be transported to receiving waters. Water quality benefits may be derived from addressing the following:

- Erosion and sediment control during construction
- Collection and proper disposal of animal waste
- Collection and proper disposal of solid waste
- Proper disposal and composting of yard waste
- Proper disposal and recycling of unused toxic waste materials
- Proper storage, disposal, and recycling of unused automotive fluids and prevention of fluid leaks
- Modified use of chemicals such as fertilizer, pesticides, and herbicides
- Safe storage, handling, and disposal of hazardous household products

Maintenance and Operational Procedures

Nonstructural maintenance and operational procedures can be used to prevent or reduce the need for more costly structural treatment controls. To ensure the proper operation of stormwater BMP systems, periodic maintenance tasks are required. The efficiency of an entire system relies on the proper upkeep of all BMP components. Nonstructural maintenance operations may consist of turf and landscape management, street cleaning, catch basin cleaning, road maintenance, canal/ditch maintenance, and modification of structural operations.

Turf and Landscape Management

Lawns and grasses planted for aesthetic and recreational use, surface stabilization, and erosion control require routine maintenance that includes irrigation, mowing, fertilization, targeted pest management, aeration, and/or dethatching. Mowing should be performed at optimal times, such as when no significant rainfall events are predicted.

Municipal “no dumping” ordinances should be enacted to prevent the disposal of cuttings and clippings in or near drainage facilities. Composting is a good disposal alternative, and the installation of a yard waste composting facility is a viable management tool. Turf and landscape management procedures should be consistent with vegetation use, growing season, and the amount of rainfall. See **Appendix B, Turf and Landscaping Best Management Practices**, for specific turf and landscape management practices.

Street Cleaning

Routine street cleaning removes accumulated depositions of solids that may otherwise be transported as contaminants in the first flush of stormwater. Efficiency depends on sweeping frequency which appears to be more effective in areas with distinct wet and dry seasons. Sweeping should increase just before the rainy season. Mechanical broom sweepers, vacuum sweepers, and street flushers are typically used for cleaning and are very effective in removing larger particles (>50 microns) and associated pollutants (i.e., solids and heavy metals). Parked cars can be an obstacle to effective sweeping and parking regulations may be required. Costs for purchasing equipment and implementing a program can be significant.

Catch Basin Cleaning

Accumulated sediments should be removed from catch basins on a regular basis to prevent clogging. Basins should be cleaned before the sump is 40 percent full. Maintenance schedules should be targeted to those areas with the highest pollutant loading. Capital costs may be high, as communities with numerous basins will need to procure mechanical cleaners such as eductors, vacuums, or bucket loaders.

Road Maintenance

Deteriorating roadway surfaces can contribute to contamination of stormwater. Potholes and worn pavement should be promptly repaired to reduce sediment loading. Minimizing the size of the impervious area is the most effective method to reduce stormwater pollution from the roadway. Aggressive maintenance programs are more cost-effective than complete roadway replacements.

Canal/Ditch Maintenance

Ditches that carry heavy flow concentrations should be periodically checked for collapsed or blocked flowways, or degradation of flowway lining materials. The channel bottom should be dredged if a buildup of sediment occurs. Illegally dumped items should be removed to reduce possible pollutants and achieve aesthetic enhancement. “No littering” signs can be posted with a call-in number to report dumping in progress. Also, if water quality will not be compromised, the characteristics of the channel can be modified to improve hydraulics.

Modification of Structural Operations

Schedules for structural operations can be modified to optimize water quality objectives. Activities such as diverting low quality water away from critical habitat areas; increasing the detention times or reducing the discharge orifice size in existing ponds; storing water for future use during drought periods; recharging the ground water table; and mixing clean water with degraded water to enhance quality are all examples of modifying operations to achieve priorities. Successful operations will reduce risk, increase water supply reliability, and enhance water quality.

Educational and Outreach Programs

Public education is a BMP that can be implemented to meet the individual needs and interests of each segment of the community. Outreach programs should be integrated into a community's overall plan for stormwater management to educate employees, the public, and businesses about the importance of protecting stormwater from improperly used, stored, and disposed pollutants. Often people are not aware of the cumulative effects of pollution generating activities. Once a pollutant has been linked with a particular community, support for a volunteer effort and public education campaign can be made through the local civic association.

Public and private funding partnerships may be needed to ensure participation and encourage development of information and infrastructure improvements. Public information can be expensive to develop and distribute and must be periodically updated and redistributed. A specific course of action must be defined and the associated cost to implement a solution determined for each problem. The initiation of a well coordinated, comprehensive campaign will be more effective at reaching audiences than a series of separate actions that seem unrelated. Potential funding sources for education programs might include such agencies as the local public works department, health department, park authority, forestry division, state department of natural resources, United States Department of Agriculture, and private conservation groups.

The public should be educated about the relationship they have with the watershed in the area where they live. Programs informing citizens of practices that reduce sources of potential pollutants in runoff will encourage them to become part of the solution. They must receive repeated messages about how their behavior affects the health of their watershed to encourage behavior modification. The effectiveness of a program can be assessed by estimating how many people will hear the message, change their behavior, and to what degree their behavior changes. A public education plan should consist of several kinds of activities that may include the following:

- Public surveys to assess use of toxic materials, disposal practices, and overall environmental awareness
- Frequent and consistent campaign messages using a mission statement, logo, and tag line

- Campaign products such as door hangers, pamphlets, guidebooks, signs, press releases, or classroom/library displays
- Public outreach activities such as having a field day where a local water quality expert comes to a community to demonstrate ways of reducing pollution
- Neighborhood programs, such as the following:
 - Identifying storm drains with stenciling to discourage dumping
 - Distributing toxics checklist for meeting household hazardous waste regulations
 - Producing displays and exhibits for school programs
 - Distributing free seedlings for erosion control
 - Creating volunteer opportunities such as water quality monitoring
 - Conducting awards ceremonies for specific neighborhood projects

VIII. STRUCTURAL BMP OPTIONS

Structural BMP mechanisms for controlling stormwater runoff in developing areas fall into two main categories: 1) retention systems and 2) detention systems. Sample diagrams of structural methods described under each category are shown in **Appendix C, Structural BMP Fact Sheets**. Other new technologies are also included.

Prior to the installation of structural BMPs, institutional ordinances and regulatory programs must be in place. These will provide for the fiscal resources to review and approve BMP plans, inspect their operation, and enforce violations in management practices. Ordinances will also assure that temporary erosion and sediment controls are in place during the construction phase.

Retention Systems

Retention systems rely on absorption of runoff to treat urban runoff discharges. Water is percolated through soils, where filtration and biological action remove pollutants. Systems that rely on soil absorption require a deep layer of permeable soils at separation distances of at least 1 foot between the bottom of the structure and seasonal ground water levels. Using retention systems in a watershed will help to preserve or restore predevelopment hydrology, increase dry weather base flow, and reduce bankfull flooding frequency. Retention BMP systems include dry retention basins, exfiltration trenches, concrete grid pavers, vegetated filter strips, and grassed swales.

Where ground water requires protection, retention systems may not be appropriate. Restrictions may also apply to systems located above sole source (drinking water) aquifers. Where such designs are selected, they should be incorporated with the recognition that periodic maintenance is necessary for these areas. Long-term effectiveness in most cases will depend on proper operation and maintenance of the entire system. Site and maintenance considerations for retention BMP systems are summarized at the end of this section in **Table 3**.

Dry Retention Basins

Dry retention basins are depressed areas where incoming urban runoff is temporarily stored until it gradually infiltrates into the surrounding soil. These should gradually drain down to maintain aerobic conditions that favor bacteria which aid in pollutant removal and to ensure the basin is ready to receive the next storm (Schueler, 1987). Runoff entering the basin is sometimes pretreated to remove coarse sediment that may clog the surface soil pore on the basin floor. Concentrated runoff should flow through a sediment trap, or a vegetated filter strip may be used for sheetflow.

Exfiltration Trenches

Exfiltration trenches are perforated pipes buried in trenches that have been backfilled with stone or sand/aggregate. Urban runoff diverted into the pipe gradually infiltrates from the pipe into the trench and into the subsoil, eventually reaching the ground water. A filter cloth surrounding the rock trench is used to minimize clogging.

Concrete Grid Pavers

Surfaces such as concrete grid pavers interspersed with areas of gravel, sand, or grass can reduce runoff volumes and trap vehicle-generated pollutants. Pavers are most effective in very low traffic grassed areas with relatively pervious in-situ soils (nondepressional soils) and require moderate maintenance. However, for best results, this option should be used in combination with other BMPs.

Vegetated Filter Strips

Strips of land with vegetated cover are designed to reduce sediment and remove pollutants. They are designed to receive overland sheetflow, but provide little treatment for concentrated flows. Recommended areas of use are for agriculture and low density development. Vegetated filter strips are often used as pretreatment for other structural practices, such as dry detention ponds and exfiltration trenches.

Grassed filter strips may develop a berm of sediment at the upper edge that must be periodically removed. Mowing will maintain a thicker vegetative cover, providing better sediment retention.

Forested strips next to water bodies should be left undisturbed except for the removal of trees that present unusual hazards and small debris that may be refloatated by high water. Periodic harvesting of some trees not directly adjacent to water bodies removes sequestered nutrients (Lowrance et al., 1985) and maintains an efficient filter through vigorous vegetation (Hochheimer et al., 1991).

Grassed Swales

Grassed swales are filtration and conveyance mechanisms that are generally used to provide pretreatment before runoff is discharged to treatment systems. Swales are typically shallow, vegetated, man-made trenches with a width-to-depth ratio equal to or greater than 6 to 1, or side slopes equal to or greater than 3-feet horizontal to 1-foot vertical. The established width should be maintained to ensure the continued effectiveness and capacity of the system (Bassler, undated). Grassed swales should be mowed to stimulate vegetative growth, control weeds, and maintain the capacity of the system (see **Appendix B**).

Table 3. Site and Maintenance Considerations for Retention BMP Systems^a

BMP Option	Site Conditions	Size of Drainage Area	Maintenance	Longevity
Dry Retention Basins	Deep permeable soils	Small	Low	High
Exfiltration Trenches	Deep permeable soils	Small	High	Low
Concrete Grid Pavers	Deep permeable soils; restricted traffic	Small	Moderate	Moderate
Vegetated Filter Strips	Low density areas	Small	Low	High if maintained
Grassed Swales	Low density areas	Small	Low	High if maintained

a. Careful attention to erosion and sediment controls is required during construction to keep sediment loads out of retention systems or failures may occur.

Detention Systems

Detention BMP systems include dry and wet detention ponds and constructed wetlands. Site and maintenance considerations for detention BMP systems are summarized at the end of this section in **Table 4**.

Dry Detention Ponds

Dry detention ponds detain a portion of urban runoff for a short period of time (i.e., up to 24 hours after a storm) using a fixed opening to regulate outflow at a specified

rate and allowing solids and associated pollutants time to settle out. In general, these systems are effective in removing total suspended solids but have low treatment efficiency for nutrients. They are normally dry between storm events. Siting requirements call for a minimum of one foot from control elevation to the bottom of the detention zone. Therefore, constructing dry detention ponds on wetlands and floodplains should be avoided. Where drainage areas are greater than 250 acres and ponds are being considered, inundation of upstream channels may be of concern.

Wet Detention Ponds

Wet detention ponds are designed to maintain a permanent pool of water and temporarily store urban runoff until it is released at a controlled rate. Hydraulic holding times are relatively short; such as hours or days. These systems are more efficient in removing soluble pollutants (nutrients) than dry detention due to the biological activity in the vegetation and water column. Enhanced designs include a forebay to trap incoming sediment where it can be easily removed. A littoral zone can also be established around the perimeter of the pond.

Constructed Wetlands

Constructed wetlands and multiple pond systems treat runoff through adsorption, plant uptake, filtration, volatilization, precipitation, and microbial decomposition (Livingston et al., 1992). Multiple pond systems in particular have shown potential to provide much higher levels of treatment (Schueler, 1992). Constructed wetlands are designed to simulate the water quality improvement functions of natural wetlands to treat and contain surface water runoff pollutants and decrease loadings. Many of these systems are currently being designed to include vegetated buffers and deep water areas to provide wildlife habitat and aesthetic enhancements. Periodic maintenance is required for these systems. Long-term effectiveness will generally depend on proper operation and maintenance of the entire system.

Constructed wetlands differ from artificial wetlands created to comply with mitigation requirements in that they do not replicate all of the ecological functions of natural wetlands. Enhanced designs may include a forebay, complex microtopography, and pondscaping with multiple species of wetland trees, shrubs, and plants.

Table 4. Site and Maintenance Considerations for Detention BMP Systems

BMP Option	Site Conditions	Size of Drainage Area	Maintenance	Longevity
Dry Detention Ponds	Any soils	Moderate to large	Low	High
Wet Detention Ponds	Any soils	Moderate to large	Low	High
Constructed Wetlands	Poorly drained soils	Moderate to large	Requires vegetation harvesting	High

Other Systems

Systems other than retention and detention systems include water quality inlets, separation devices, and chemical treatment. Site and maintenance considerations for other BMP systems are summarized at the end of the section in **Table 5**.

Water Quality Inlets

Water quality inlets rely on settling to remove pollutants before discharging water to the storm sewer or other collection system. They are also designed to trap floating trash and debris. When inlets are coupled with oil/grit separators and/or hydrocarbon absorbents, hydrocarbon loadings from high traffic/parking areas may be reduced. However, experience has shown that pollutant-removal effectiveness is limited, and the devices should be used only when coupled with extensive clean-out methods (Schueler et al., 1992). Maintenance must include proper disposal of trapped coarse-grained sediments and hydrocarbons. Clean-out and disposal costs may be significant.

Catch basins are water quality inlets in their simplest form. They are single-chambered inlets with a lowered bottom to provide 2 to 4 feet of additional space between the outlet pipe for collection of sediment at the bottom of the structure.

Some water quality inlets include two chambers. The first provides effective removal of coarse particles and helps prevent premature clogging of the filter media. A second chamber contains a sand filter to provide additional removal of finer suspended solids by filtration.

Separation Devices

Separation devices include sumps, baffle boxes, oil/grit separators, and sediment basins to capture trash, sediments, and floating debris. They are efficient only within specific ranges of volume and discharge rates. Control units usually have a forebay to pretreat discharges by separating heavy grit and floating debris before it enters the separator. Separation processes use gravity, vortex flow, centrifugal force, and even direct filtration. Further treatment may be accomplished by adding chemicals such as alum. After separation, the sediment is collected and transported or pumped to a waste treatment facility. These devices may have a high initial investment cost.

Chemical Treatment

Chemical processes include coagulation coupled with solids separation to remove pollutants. Iron, aluminum metal salts, and alum are used to coagulate compounds, then polymers are added to enhance flocculation and induce settling. The resulting settled floc and solids would need to be disposed and may need dewatering prior to disposal. Chemical processes offer the advantage of low land requirements, flexibility, reliability, decreased detention time requirements, and the ability to enhance water quality to levels substantially lower than could be achieved using other methods alone. The drawbacks are

high capital, operations and maintenance costs, and solid waste management requirements.

Table 5. Site and Maintenance Considerations for Other BMP Systems

BMP Option	Site Conditions	Size of Drainage Area	Maintenance	Longevity
Water Quality Inlets	Applicable to many sites, including high density areas with poorly drained soils and extensive impermeable areas	Small	High, if clean out of sediment and debris is performed routinely	High if maintained
Separation Devices	Applicable to many sites, including high density areas with poorly drained soils and extensive impermeable areas	Small	High, if clean out of sediment and debris is performed routinely	High if maintained
Chemical Treatment	Applicable to many sites, including high density areas with poorly drained soils and extensive impermeable areas	Moderate to large	High, if there is continual input of chemicals along with removal of spent precipitate	High if maintained

IX. OPPORTUNITIES FOR BMP IMPLEMENTATION

New Development

Before development occurs, land in a watershed is available for a number of pollution prevention and treatment options. While BMPs can be implemented during the planning, design, and construction stage, they must continue to be implemented during the life of the project. Prevention practices such as planning and zoning tools to ensure setbacks, buffers, and open space requirements can be implemented with ease at the planning stage of any development with a high degree of success. In addition, compliance with local regulations through permitting processes can guarantee incorporation of treatment options such as wet ponds or constructed wetlands that can improve the water quality of stormwater runoff. All BMPs discussed in this document are applicable for new developments as site conditions allow.

Retrofitting

In already developed areas, pollution prevention and reduction practices may be more feasible than treatment controls due to land restrictions. A comprehensive management plan can be developed to first identify pollutant reduction opportunities, then

protect existing natural areas that can help control runoff, and finally begin ecological restoration and retrofit activities to clean up degraded water bodies. Citizens can help prioritize the cleanup strategies, volunteer to become involved with restoration efforts and help protect ecologically valuable areas.

Installing or retrofitting water management systems in existing developed areas can be a difficult and costly endeavor. Communities can examine areas where BMPs were constructed for flood control purposes to determine if they can be modified to provide water quality benefits. For example, a dry pond can be converted to a wet pond or it can be modified to increase the detention time by reducing the size of the control outlet. Wet ponds can be planted with aquatic vegetation to promote biological uptake processes.

When selecting retrofit program control options, be sure to include structural and nonstructural BMPs. Some examples of BMP options are shown in **Table 6**.

Site Construction

During the construction stage, whether for new development or retrofit, BMPs can be implemented to control pollutants resulting from the erosion of disturbed soils. Most of these practices focus on controlling the amount of soil erosion and sedimentation, thereby minimizing subsequent adverse impacts of downstream water bodies. In addition, application, generation, and migration of toxic substances can be limited by properly storing, handling, applying, and disposing of pesticides, petroleum products, nutrients, solid wastes, and construction chemicals. For example, construction sites should establish fuel and vehicle maintenance staging areas; equipment and machinery washing areas; and separate storage, handling, and mixing areas for pesticides and fertilizers, all located away from waterways. As with new development and retrofits, the educational component is critical to the effectiveness of any of the BMPs. Construction workers need to be trained about the goals of the plan and actions required of them for the BMP to be successful.

An effective plan for minimizing and controlling erosion and sedimentation during construction shall include, at a minimum, the following basic principles:

- Minimize soil exposure through organized scheduling of grading and construction activities
- Retain existing vegetation whenever feasible
- Stabilize all denuded areas within 3 days after final grading; disturbed areas that are inactive and will be exposed to rain for 30 days or more should be temporarily stabilized; stabilization techniques include mulches, vegetation and sod, and chemical applications
- Control runoff by diverting stormwater away from stripped areas or newly seeded slopes, minimize the length and steepness of slopes, and install check dams, level spreaders, and outlet protection to prevent erosion
- Install sediment trapping structures such as silt traps, sediment basins, filter fabric, perimeter dikes, and inlet protection
- Inspect and maintain control measures regularly

Table 6. BMP Options for Retrofit Control

Major Structural Controls	<ul style="list-style-type: none"> • Sedimentation or filtration units • Dry detention ponds (conversion to wet ponds) • Retaining walls • Sanitary sewer rehabilitation • Constructed wetlands • Chemical treatment
Minor Structural Controls	<ul style="list-style-type: none"> • Rip rap at pipe outfalls • Retrofit of catch basins with oil traps and/or grit traps and/or filters • Trash racks • Curb inlet filters • Oil-grit and oil-water separators • Exfiltration trenches and/or buffer strips • Grassed swales
Major Nonstructural Controls	<ul style="list-style-type: none"> • Bank stabilization of waterways • Dredging in drainage ways • Water body cleanup effort • Open space acquisition • Ordinances and regulatory programs • Conservation, recycling, and source control programs
Minor Nonstructural Controls	<ul style="list-style-type: none"> • Enhanced street sweeping • Parking lot sweeping • Storm drain stenciling • Vegetation control in main ditches
Preventative/Maintenance Oriented Controls	<ul style="list-style-type: none"> • Increased frequency of catch basin and manhole cleaning • Turf and landscape management • Road maintenance • Ditch/creek cleaning
Public Awareness and Education	<ul style="list-style-type: none"> • Litter prevention • Trash and debris dumping prevention • Toxic materials/oil and grease dumping prevention
Enhanced Enforcement	<ul style="list-style-type: none"> • Construction activities • Illegal dumping and disposal • Commercial non-stormwater discharges
Continuing Assessment	<ul style="list-style-type: none"> • Sediment sampling • Dry weather monitoring • Wet weather monitoring • Facility, appurtenances, and other BMP inspection

X. CONCLUSIONS

Water management activities have evolved from singular practices that addressed individual needs and crisis situations to multiple objective programs that manage water supply and conservation, and preservation of surface water and natural systems. The continued growth of the population demands that we take a holistic approach in water resource planning and management to support our quality of life.

As stormwater runoff is a major source of pollution to our wetlands, rivers, lakes, and estuaries, local governments must take responsibility for its control. No water quality control program should be implemented in a vacuum. An understanding of the origin and causes of nonpoint source pollution is essential to the development of comprehensive, effective, and efficient control practices. BMPs should be integrated into multiple objective programs to ensure that watershed goals are cooperatively met. Such programs will fall under state and regional water policies and ordinances and should be consistent with comprehensive short- and long-term objectives.

In many cases, BMP implementation can provide supplemental benefits for local citizens. Environmental and aesthetic enhancements can be achieved through thoughtful design, conscientious maintenance, and creative landscaping.

XI. REFERENCES

- Bassler, R.E., Jr. Undated. *Grassed Waterway Maintenance*. Agricultural Engineering Fact Sheet No. 129, Cooperative Extension Service, University of Maryland, College Park, MD.
- Buck, E.H. 1991. *Corals and Coral Reef Protection*. CRS report for Congress, Congressional Research Service, Washington, D.C.
- Camp, Dresser, and McKee, Inc. 1993. *California Municipal Best Management Practice Handbook*. Stormwater Quality Task Force, CA.
- Chesapeake Bay Local Government Advisory Committee. 1988. *Recommendations of the Nonpoint Source Control Subcommittee to the Local Government Advisory Committee Concerning Nonpoint Source Control Needs*. A draft white paper for discussion at the Local Government Advisory Committee's First Annual Conference.
- CH2M Hill. 1991. *Best Management Practices and Construction Standards for Local Government Stormwater Management*. SEF30359.A0, Deerfield Beach, FL.
- Department of Environmental Resources. 1997 (REV 112597). *Low-Impact Development Design Manual*. Prince George's County, Maryland.
- FDEP. 1995. *Best Management Practices for Golf Course Maintenance Departments*. Florida Department of Environmental Protection, Tallahassee, FL. 18 pp.
- FDER. 1992. *The Florida Development Manual - A Guide to Sound Land and Water Management*, Florida Department of Environmental Regulation, Tallahassee, FL.

- Florida Fertilizer and Agrichemical Association. 1997. *Best Management Practices for Blended Fertilizer Plants in Florida*. Tallahassee, FL. 13 pp. + Appendices.
- Harper, H.H. 1985. *Fate of Heavy Metals from Highway Runoff in Stormwater Management Systems*. Ph.D. Dissertation, University of Central Florida, Orlando, FL.
- Harper, H.H. 1999. Stormwater Chemistry and Water Quality: Estimating Pollutant Loadings and Evaluation of Best Management Practices for Water Quality Improvements. *In: Proceedings 6th Biennial Stormwater Research and Watershed Management Conference*. September 14-17, 1999. Southwest Florida Water Management District, Tampa, FL.
- Hochheimer, A., A. Cvacas, and L. Shoemaker. 1991. *Interim Report: Vegetative Buffer Strips Draft*. Prepared by Tetra-Tech, Inc., for the United States Environmental Protection Agency.
- Horner, R.R. 1994. *Fundamentals of Urban Runoff Management: Technical and Institutional Issues*. Terrene Institute and United States Environmental Protection Agency, Washington, DC. 301 pp.
- Livingston E., E. McCarron, J. Cox, and P. Sanzone. 1992. *The Florida Development Manual: A Guide to Sound Land and Water Management*. Florida Department of Environmental Resources, Tallahassee, FL.
- Lowrance, R., R. Leonard, and J. Sheridan. 1985. Managing Riparian Ecosystems to Control Nonpoint Pollution. *Journal of Soil and Water Conservation* 40(1):87-91.
- Northern Virginia Planning District Commission. 1996. *Nonstructural Urban BMP Handbook*. Annandale, Virginia. 306 pp.
- Randall, C.W., K. Ellis, T.J. Grizzard, and W.R. Knocke. 1982. Urban Runoff Pollutant Removal by Sedimentation. *In: Stormwater Detention Facilities, Proceedings of an Engineering Foundation Conference*, ASCE, New York, NY.
- Schueler, T.R. 1987. *Controlling Urban Runoff: A Practical Manual for Planning and Designing Urban Best Management Practices*, Metropolitan Washington Council of Government, Washington, D.C.
- Schueler, T.R. 1992. *A Current Assessment of Urban Best Management Practices*. Metropolitan Washington Council of Governments. Washington, DC, 127 pp.
- Schueler, T.R. 1992. *Design of Stormwater Wetland Systems*. Metropolitan Washington Council of Governments, Washington, D.C.
- SFWMD, 1988. *An Assessment of Urban Land Use/Stormwater Runoff Quality Relationships and Treatment Efficiencies of Selected Stormwater Management Systems*. Technical Publication 88-9, South Florida Water Management District, West Palm Beach, FL.
- Terrene Institute and USEPA. 1996. *A Watershed Approach to Urban Runoff: Handbook for Decisionmakers*. Terrene Institute, Washington, DC, in cooperation with Region 5 United States Environmental Protection Agency, Chicago, IL.

- Urban Drainage and Flood Control District. 1999. *Urban Storm Drainage, Criteria Manual, Volume 3 - Best Management Practices*. Denver, Colorado.
- USEPA. 1983. *Final Report of the Nationwide Urban Runoff Program, Final Draft, Volume 1*. WH-554, Water Planning Division, United States Environmental Protection Agency, Washington, DC.
- USEPA. 1986. *Quality Criteria for Water 1986*. Report 440/586001, Office of Water, United States Environmental Protection Agency, Washington, DC.
- USEPA. 1993. *Guidance Specifying Management Measures for Sources of Nonpoint Pollution in Coastal Waters*. EPA-840-B-92-002, United States Environmental Protection Agency, Washington, DC.
- USEPA. 1999. *Preliminary Data Summary of Urban Stormwater Best Management Practices*. EPA-821-R-99-012, United States Environmental Protection Agency, Washington, DC.
- Wanielista, M.P. 1977. *Quality Considerations in the Design of Holding Ponds*. Stormwater Retention/Detention Basins Seminar, University of Central Florida, Orlando, FL.
- Wyoming Department of Environmental Quality. 1999. *Urban Best Management Practices for Nonpoint Source Pollution*. Cheyenne, WY, 139 pp.

Appendix A

TYPICAL COSTS ASSOCIATED WITH STRUCTURAL BMPS

The typical costs associated with each BMP type, along with maintenance issues and concerns and design guidelines and resources, are summarized in **Table A-1**. The references used to compile the information in the table are listed following the table. The superscripts following items in the table indicate the reference from which the information was obtained.

Table A-1. Typical Costs Associated with Structural BMPs

BMP Type	Installation or Construction Costs	Operation, Inspection, and Maintenance Costs	Maintenance Issues and Concerns	Design Guidelines and Resources
RETENTION SYSTEMS				
Dry Retention Basins	\$0.50-\$1.00 per cubic foot (cu. ft.) of storage. ¹³	<ul style="list-style-type: none"> • Annually, 3-6% of initial construction costs¹³ 	<ul style="list-style-type: none"> • Facility must be inspected every 6 months or after a major storm event and any debris must be removed. • Control structure must be inspected and maintained semiannually and repaired as needed. • Accumulated sediments must be removed at least once annually. • Rototilling or disking the basin bottom should be done annually. • Embankments and side slopes must be maintained. • Use fertilizers only if absolutely necessary. 	Refer to Section SW BMP 3.07, in <i>The Florida Development Manual - A Guide to Sound Land and Water Management</i> . ⁴
Exfiltration Trenches	\$2.50-\$7.91 per cu. ft. of treatment volume. ^{12,13,16,20}	<ul style="list-style-type: none"> • Costs are annually averaged to 3-20% of capital cost for buffer strip maintenance, trench inspection, and rehabilitation that is required every 5-15 years.^{9,11,13,20} • Trench rehabilitation depends on site conditions and degree of clogging.¹⁶ 	<ul style="list-style-type: none"> • Trenches must be inspected regularly and debris removed, especially after large rain events. • Periodic repair and sediment removal is needed to facilitate exfiltration. 	Refer to the <i>Management and Storage of Surface Water - Permit Information Manual, Vol. IV, Design Example of Exfiltration Trench</i> , ¹⁰ and Section SW BMP 3.03 in <i>The Florida Development Manual - A Guide to Sound Land and Water Management</i> . ⁴
Concrete Grid Pavers	\$0.50-\$2.00 per square foot (sq. ft.) of surface area. ^{21,12}	<ul style="list-style-type: none"> • 5% of initial construction costs.²¹ 	<ul style="list-style-type: none"> • Trash, grass clippings, and other debris should be removed from the surface of the area as needed. • Pavers must be inspected regularly and debris removed, especially after large rain events. • Nutrient and pesticide management should be performed as needed. 	Refer to Section SW BMP 3.01 in <i>The Florida Development Manual - A Guide to Sound Land and Water Management</i> . ⁴

Table A-1. Typical Costs Associated with Structural BMPs (Continued)

BMP Type	Installation or Construction Costs	Operation, Inspection, and Maintenance Costs	Maintenance Issues and Concerns	Design Guidelines and Resources
Vegetated Filter Strips	<p>\$0.00-\$1.30 per sq. ft.</p> <p>The lowest cost assumes that existing vegetation was used. The higher cost assumes sod was used.¹³</p>	<ul style="list-style-type: none"> • \$100-\$1,400 per acre annually. • The lower cost assumes that existing vegetation was used. • The higher cost assumes sod was used.¹² 	<ul style="list-style-type: none"> • Mowing must be performed as needed. • Aeration of filter strips is required. • Maintaining a healthy vegetation aids in removal efficiency and prevents erosion. • Sediment buildup must be removed annually to prevent a damming effect. • Nutrient and pesticide management should be performed as needed.^{12,19} • Periodic harvesting of some trees not directly adjacent to water bodies removes sequestered nutrients and maintains an efficient filter through vigorous vegetation. • To minimize soil compaction, vehicular traffic and excessive pedestrian traffic should be avoided. • Periodic repair and sediment removal is needed to prevent channelization. 	<p>Refer to Section SW BMP 1.61-1.85 and 3.04 in <i>The Florida Development Manual - A Guide to Sound Land and Water Management</i>.⁴</p>
Grassed Swales	<p>\$0.60-\$1.60 per sq. ft.^{11,19}</p>	<ul style="list-style-type: none"> • Annually 5-7% of initial construction costs.¹³ 	<ul style="list-style-type: none"> • The established width should be maintained to ensure the continued effectiveness and capacity of the system. • Grassed swales should be mowed to stimulate vegetative growth, control weeds, and maintain the capacity of the system. • Inspections, vegetation maintenance, mowing, and debris removal are required at least annually. • Inspect check dams for erosion at least annually. • Sediment removal, reseeding, or resodding should be done at least every 5 years.⁴ • Nutrient and pesticide management should be performed as needed. • Residents that have swales must be educated on their maintenance requirements. 	<p>Refer to Section SW BMP 3.04 in <i>The Florida Development Manual - A Guide to Sound Land and Water Management</i>.⁴</p> <p>General design criteria are also detailed in the <i>Stormwater Technology Fact Sheet, Vegetated Swales</i>.¹⁹</p>

Table A-1. Typical Costs Associated with Structural BMPs (Continued)

BMP Type	Installation or Construction Costs	Operation, Inspection, and Maintenance Costs	Maintenance Issues and Concerns	Design Guidelines and Resources
DETENTION SYSTEMS				
Dry Detention Ponds	\$0.50-\$1.00 per cu. ft. of storage. ¹³	<ul style="list-style-type: none"> • 1-5% of initial construction costs averaged annually.^{12,13} 	<ul style="list-style-type: none"> • Facility must be inspected every 6 months or after a major storm event and any debris must be removed. • Control structure must be inspected and maintained semiannually, and repaired as needed.¹³ • Accumulated sediments must be removed at least once annually. • Rototilling or disking the basin bottom should be done annually. • Embankments and side slopes must be maintained. • Use fertilizers only if absolutely necessary. 	Dry detention pond requirements are specified in <i>Management and Storage of Surface Waters - Permit Information Manual Volume IV</i> , ¹⁰ and USEPA, 1999e. ¹⁷ Also, refer to Section SW BMP 3.07 in <i>The Florida Development Manual - A Guide to Sound Land and Water Management</i> . ⁴
Wet Detention Ponds	Overall \$0.50-\$1.00 per cu. ft. of storage. ³ Costs depend on topography and soils. A natural area of depression and pliant soils reduce costs.	<ul style="list-style-type: none"> • Annually 3-5% of initial construction costs⁸ (includes grass mowing, debris and litter removal, inlet, outlet, embankment inspections, sediment removal, and disposal). 	<ul style="list-style-type: none"> • Facility must be inspected every six months or after a major storm event and any debris must be removed. • Control structure must be inspected and maintained semiannually, and repaired as needed. • Accumulated sediments must be removed every five years. • Embankments and side slopes must be maintained and repaired as needed. • Use fertilizers only if absolutely necessary. 	Refer to <i>Management and Storage of Surface Waters - Permit Information Manual Volume IV</i> , ¹⁰ and Section SW BMP 3.02 in <i>The Florida Development Manual - A Guide to Sound Land and Water Management</i> . ⁴
Constructed Wetlands	\$0.05-\$1.00 per cu. ft. of storage. ^{13,18}	<ul style="list-style-type: none"> • Annually 1-5% of initial construction costs.^{13,18} 	<ul style="list-style-type: none"> • Slope control and removal of sediment in forebays. • Removal of trash, debris, and nuisance species. • Supplemental plantings. 	Isolated wetland requirements are specified in <i>Management and Storage of Surface Waters - Permit Information Manual Volume IV</i> . ¹⁰ General design criteria are detailed in the <i>Stormwater Technology Fact Sheet, Stormwater Wetlands</i> . ¹⁸

Table A-1. Typical Costs Associated with Structural BMPs (Continued)

BMP Type	Installation or Construction Costs	Operation, Inspection, and Maintenance Costs	Maintenance Issues and Concerns	Design Guidelines and Resources
OTHER SYSTEMS				
Water Quality Inlets	Capital costs range from \$1,100-\$3,000 per precast unit ¹² and \$600-\$900 for retrofitted unit ² .	<ul style="list-style-type: none"> Hydrocarbon absorbents cost approximately \$100². Maintenance of each unit costs \$7.50-\$90 per unit assuming the unit is cleaned out two times each year². 	<ul style="list-style-type: none"> Proper disposal of trapped coarse-grained sediments and hydrocarbons is required. Clean-out and disposal costs may be significant. Maintenance requirements are high if clean out of sediment and debris is performed routinely. Requires replacement of hydrocarbon absorbent at least once per year. 	Local design manuals and vendor catalogs for retrofit units and hydrocarbon absorbent.
Separation Devices	Capital costs range from \$2,300-\$40,000 per precast unit. The size of the unit is based on site specific conditions. ¹⁵	<ul style="list-style-type: none"> The cost of cleaning out separator systems varies depending on the type of separator used, normally less than \$1,000 per year.¹⁵ 	<ul style="list-style-type: none"> Period inspections and sediment removal are required.¹⁵ Proper disposal of trapped coarse-grained sediments is required. Clean-out and disposal costs may be significant. Maintenance requirements are high if clean out of sediment and debris is performed routinely. 	General design criteria are detailed in the <i>Stormwater Technology Fact Sheet, Hydrodynamic Separators</i> . ¹⁵
Chemical Treatment	For an alum stormwater treatment facility, with an average cost of \$245,000 per system serving a drainage area with an average size of 310 acres, the average cost is \$790 per acre treated. ⁵	<ul style="list-style-type: none"> Average annual operation and maintenance cost is \$100 per acre of drainage area served.⁵ 	<ul style="list-style-type: none"> Maintenance is high if chemicals are continually input and spent precipitate is removed. Accumulated alum floc must be pumped out of the sump area on a periodic basis. The accumulated floc is normally sent to a landfill, but some systems allow for automatic floc disposal into the sanitary sewer or adjacent drying beds.⁵ 	Not available.

REFERENCES

1. American Public Works Association. 1984. *Urban Stormwater Management, Special Report No. 49*, Chicago, Illinois.
2. ASCE-EWRI. 2001. *A Guide for Best Management Practice (BMP) Selection in Urban Developed Areas*.
3. Center for Watershed Protection. 1998. *Cost and Benefits of Stormwater BMPs*. Ellicott City, MD.
4. FDER. 1992. *The Florida Development Manual - A Guide to Sound Land and Water Management*, Florida Department of Environmental Regulation, Tallahassee, FL.
5. Harper, H.H., J.L. Herr, and E. Livingston. 1998. Alum Treatment of Stormwater: The First Ten Years. *New Applications in Modeling Water Systems*. Orlando, FL.
6. Herr, J.L., and H.H. Harper. 1999. *Removal of Gross Pollutants from Stormwater Runoff Using Liquid/Solid Separation Structures*.
7. NVPDC and Engineers and Surveyors Institute. 1992. *Northern Virginia BMP Handbook: A Guide to Planning and Designing Best Management Practices in Northern Virginia*. Northern Virginia Planning District Commission and Engineers and Surveyors Institute, VA.
8. Schueler, T.R. 1992. *A Current Assessment of Urban Best Management Practices*, Metropolitan Washington Council of Governments, Washington, DC.
9. Schueler, T.R. 1987. *Controlling Urban Runoff: A Practical Manual for Planning and Designing Urban Best Management Practices*, Metropolitan Washington Council of Governments, Washington, DC.
10. SFWMD. 1994. *Management and Storage of Surface Waters - Permit Information Manual Volume IV*. South Florida Water Management District, West Palm Beach, FL.
11. SEWRPC. 1991. *Costs of Urban Nonpoint Source Water Pollution Control Measures* Technical Report No. 31, Southeastern Wisconsin Regional Planning Commission, WI.
12. USEPA. 1993. *Guidance Specifying Management Measures for Sources of Nonpoint Pollution in Coastal Waters*. EPA 840-B-92-002, Office of Water, United States Environmental Protection Agency, Washington, DC.
13. USEPA. 1999a. *Preliminary Data Summary of Urban Stormwater Best Management Practices*. EPA 821-R-99-012, Office of Water, United States Environmental Protection Agency, Washington, DC.
14. USEPA. 1999b. *Stormwater O&M Fact Sheet - Catch Basin Cleaning*. EPA 832-F-99-011, Office of Water, United States Environmental Protection Agency, Washington, DC.

15. USEPA. 1999c. *Stormwater Technology Fact Sheet - Hydrodynamic Separators*. EPA 832-F-99-017, Office of Water, United States Environmental Protection Agency, Washington, DC.
16. USEPA. 1999d. *Stormwater Technology Fact Sheet - Infiltration Trench*. EPA 832-F-99-019, Office of Water, United States Environmental Protection Agency, Washington, DC.
17. USEPA. 1999e. *Stormwater Technology Fact Sheet - Porous Pavement*. EPA 832-F-99-023, Office of Water, United States Environmental Protection Agency, Washington, DC.
18. USEPA. 1999g. *Stormwater Technology Fact Sheet - Stormwater Wetlands*. EPA 832-F-99-025, Office of Water, United States Environmental Protection Agency, Washington, DC.
19. USEPA. 1999h. *Stormwater Technology Fact Sheet - Vegetated Swales*. EPA 832-F-99-006, Office of Water, United States Environmental Protection Agency, Washington, DC.
20. USEPA. 1999i. *Stormwater Technology Fact Sheet - Wet Detention Ponds*. EPA 832-F-99-048, Office of Water, United States Environmental Protection Agency, Washington, DC.
21. USEPA. 2000. *Draft National Urban Management Measure Guidance*. Office of Water, United States Environmental Protection Agency, Washington, DC.

Appendix B

TURF AND LANDSCAPING BEST MANAGEMENT PRACTICES

Proper fertilization, irrigation, and mowing practices lead to healthy lawns and urban landscaping. A healthy lawn *can* exist in harmony with local and regional natural systems, especially in areas with considerable amounts of developed land including impervious surfaces such as parking lots, sidewalks, and driveways.

Proper fertilization of turf grass will produce a dense root system and can actually reduce leaching and runoff. A lawn with a good root system and shoot density reduces pollution because it allows for greater infiltration of stormwater into both the thatch and root zones of the lawn. This filtering process facilitates the breakdown of various types of organic pollutants and pesticides and significantly reduces the possibility of pollution runoff by helping to impede the movement of stormwater.

FERTILIZER BMPS

Choosing Fertilizer

When purchasing fertilizer, read the labels and choose one that fulfills the following criteria:

1. It is a slow release fertilizer. Homeowners and other nonprofessionals should use only slow release fertilizers. Only a trained professional should apply products comprised predominately of quick release or water-soluble fertilizers. Slow release fertilizers will significantly reduce the potential for nutrient runoff and leaching because it has been manufactured to release nutrients gradually. Therefore, fertilizers having a higher percentage of slow-release nutrients have reduced potential for environmental impact and damage to the turf grass.
2. It contains 30 to 50 percent or more slow release nitrogen and little phosphorus. Every fertilizer label has three numbers representing the percent by weight of nitrogen, phosphorus, and potassium in the fertilizer. For example, a fertilizer bag with the numbers “8-2-10” indicates that the bag of fertilizer contains 8 percent nitrogen, 2 percent phosphorus, and 10 percent potassium.
 - **Nitrogen** - When fertilizing lawns in South Florida, use a fertilizer with 30 to 50 percent (or more) of slow release form of nitrogen. Up to one pound of slow release nitrogen can be applied per 1,000 square feet at each fertilizer application. If you are not using slow release fertilizer,

apply no more than one-half pound of nitrogen per 1,000 square feet with any single application.

- **Phosphorus** - Phosphorus is the second number in the fertilizer analysis identified on every fertilizer bag. Most landscapes in South Florida do not need additional amounts of phosphorus applied to the soil. Misapplication of phosphorus has the potential to result in nutrient pollution. The high levels of phosphorus in stormwater that drain into South Florida canals pose a serious threat to the water quality of the Everglades. Therefore, before using a fertilizer containing more than 2 percent phosphorus, test the soil to determine if adding phosphorus is warranted.
 - **Potassium** - Potassium is the third number in the fertilizer analysis identified on every fertilizer bag. Potassium is believed by some lawn applicators to provide the lawn with increased stress tolerance against effects of drought, cold temperatures, and traffic by strengthening the root system.
3. The label contains complete directions for proper application procedures. Besides increasing the potential for nutrient runoff or leaching into canals and waterways, too much fertilizer can promote disease in the lawn, excessive damage from insects, and unnecessary stress from droughts.

Application

When applying fertilizer, practice the following:

1. For both your lawn and the environment, it is better to apply fertilizer to turf grass in three small applications throughout the year than in one single application.
2. If possible, reduce application rates in the summer if possible.
3. Watch the weather before fertilizing. Whenever possible, postpone fertilizing when a precipitation of greater than 1 inch of rain is expected. This will also reduce the loss of fertilizer to stormwater that will end up in nearby canals or waterways.
4. Calibrate and adjust fertilizer spreaders to prevent misapplication.
5. To prevent spillage, use a tarp or sheet of plastic under the spreader when filling or emptying fertilizer spreaders.
6. Maintain a minimum three-foot “ring of responsibility” around waterways by keeping fertilizer and pesticide applications away from the water’s edge or the “edge of vegetation.”

7. When applying fertilizer, make sure that the fertilizer does not fall onto impervious surfaces such as sidewalks, driveways, or streets. Sweep or blow granular fertilizers off hard surfaces onto the lawn. Never “hose off” fertilizer that has been spilled onto an impervious surface.
8. After emptying the unused fertilizer in the spreader back into the bag, rinse the spreader out in a corner of the yard. Do not wash the fertilizer spreader on an impervious surface.
9. Remember to use slow release a fertilizer with a low percentage of phosphorus and read and follow the label very carefully.

TURF IRRIGATION BMPS

Properly irrigating turf grass will keep water in the root zone, reduce excess application of water, and retain stormwater on site. This can be accomplished by implementing the following BMPs:

1. Let your grass tell you when to water. The lawn requires irrigation when it shows a wilt in the late afternoon for several days or a week. Only irrigate in accordance with water restrictions. Single-event timers can be integrated into your sprinkler systems, allowing you make a conscientious decision each time you irrigate.
2. Irrigate the lawn just enough to replenish the root zone. Approximately 3/4 inch of water will accomplish this. Depending on the type of spray heads, this may be as short as 13 minutes or as long as 30 minutes, provided that the heads are properly spaced. Rotary heads typically require longer intervals, typically 30 minutes to 1.5 hours or more. The appropriate watering interval can be determined based on system characteristics or a “catchment” can test.
3. Test your system using a “catchment can” test. Scatter 20 to 30 cylinder containers (such as soup cans) throughout the landscape, run the zone for a defined period (such as 30 minutes), and measure the depth in each can. The results will tell you how long you must irrigate, and will pinpoint problem areas for maintenance or redesign. Periodically retest your sprinkler system, inspect spray patterns, and ensure uniformity of watering by providing overlap with head-to-head coverage.
4. Use a rain gauge and turn off your time clock if your lawn has received 3/4 inch of rain. A rain gauge is a useful reminder that rainfall provides all the water a lawn requires most of the year in Florida.
5. Add a rain shut-off device to your sprinkler system or an in-ground moisture sensor such as a tensiometer. Such a device or sensor overrides the normally scheduled irrigation whenever sufficient rain has occurred. This is especially helpful if you plan to be away from your home.

6. Encourage and remind your neighbors to implement BMPs as well. Share this information with them and talk about Florida's wet-dry cycle and about everyone's responsibility to respect and abide by irrigation laws.
7. Encourage your municipality (or the county) to enforce irrigation laws.
8. Make sure the people you hire to install and repair your irrigation system are licensed professionals.
9. Adopt performance standards for irrigation systems so that when they are installed, they meet targeted efficiency and uniformity of application criteria.
10. Lay out irrigation systems efficiently to attain high uniformity. Use a pipe size large enough to keep pressure losses at a minimum, and to help achieve uniformity. Establish separate zones for turf and ornamental plants. Use drip or micro irrigation for shrubs and bedded plants. Place rotary heads and spray heads in separate zones. Make sure that all sprinklers are placed as closely as recommended in manufacturers' specifications. This normally requires that the radius covered by one sprinkler head should just barely reach the adjoining sprinkler heads.
11. Examine the irrigation system and repair any leaks. Clean out clogged sprinkler emitters, and remove obstacles and low overhanging branches that block stream flow. Raise any sprinkler heads that do not clear the turf canopy, or use pop-ups. Replace any heads and fittings that are broken or cracked. Use partial (half- or quarter-circle) heads to replace full-circle heads that over spray onto the street or buildings. Consider adding heads in areas that do not receive enough water. The solution to dry spots is to fix the irrigation in that zone, and not to over water the rest of your property to compensate for poor coverage.
12. Vary irrigation schedules according to the season. For example, from November through February, irrigate St. Augustine grass no more than once every seven days, and from March through October, irrigate it two times per week, except after rain.
13. Use an irrigation schedule suitable for the type of grass and the terrain. For example, Bahia grass in level areas can be maintained year-round with no irrigation.
14. When establishing or renovating a new lawn, make sure that the sod does not dry out, but irrigate no more than once a day.
15. Water your lawn infrequently and deeply. Frequent shallow irrigation encourages a shallow root system, which has a small soil moisture reserve and will make the lawn more susceptible to drought. Frequent irrigation also fails to take advantage of the fact that it is rarely dry for long in South Florida, and by waiting a little longer for rainfall, it is possible that you will not have to irrigate at all. Grasses that are over

watered go into a condition of luxuriant water use and they will use water less efficiently.

16. Capture and recycle rainwater for use on turf, thereby reducing reliance on city water. For example, raised road areas can avoid the use of hard curbing to allow water to run off into the landscape. An approach for parking lots is to interrupt curbing with gaps that permit drainage into the landscape.
17. Comply with seasonal water use restrictions imposed by the South Florida Water Management District or other authority.
18. Remember, with or without water conservation restrictions, do not irrigate your lawn between 8:00 a.m. and 5:00 p.m. For best results, water in the early morning. A predawn watering is the most productive type of irrigation because there is less wind at this time.

VEGETATION MANAGEMENT BMPS

Typical urban landscapes that are not maintained using BMPs can at best be unwelcome neighbors to natural communities, and at worst a serious threat to natural systems. It is possible, however, to maintain urban landscapes in a manner that allows the urban environment to coexist with natural systems with little or no degradation of the natural environment. Two types of BMPs can help accomplish this. The first type maintains a healthy vegetative cover that will reduce the amount of phosphorus, nitrogen, and other potential pollutants from entering into regional canals, waterways, lakes, and ultimately the Everglades. The second type of BMPs are cultural practices that keep turf and landscaping healthy and tolerant to South Florida seasons, insects and pests, and other environmental stresses.

Vegetative Cover BMPs

1. When selecting plant materials consider native species or noninvasive plant species that are adapted to South Florida's tropical and subtropical environment and can thrive despite fluctuations in the region's wet and dry seasons.
2. Select plants from a reputable nursery, garden center, or sod farm to insure healthy, conditioned plants that are free of pests and weeds.
3. When installing plants, make sure they are properly sited, depending on the plant, with respect to sunlight, drainage and space requirements. This will help improve the chances for successful establishment and will reduce future maintenance needs.

Cultural Practices

1. Mow at the recommended height for your grass species. For Bahia and St. Augustine grasses, the recommended height is generally the highest

- setting your mower can be set at. Be careful not to remove any more than one-third of the leaf blade at a time because the removal of more tissue will stress the grass, leaving it more vulnerable to drought or insects.
2. Mowing at least once a week will produce a lawn with a deeper, more extensive root system. Deeper root systems result in better tolerance of environmental stresses such as drought, shade and traffic. Proper mowing practices will also result in fewer problems with insects or disease.
 3. Practice “grass cycling,” or mulching by leaving clippings on the ground. This helps to return nutrients to the soil. Encourage neighborhood or homeowner associations to allow composting and follow recommended practices for composting organic wastes such as grass clippings, leaves, and other organic waste.
 4. Make sure grass clippings do not blow into water bodies or onto impervious surfaces such as driveways, sidewalks, or street curbs where they will eventually end up in your canal or lake during rain events. Nutrients trapped in organic matter, such as grass clippings, leaves, and branches, can be rereleased as pollutants when organic debris enters basin canals, waterways, and lakes.
 5. Properly prune trees at least annually to reduce storm-generated leaf and limb debris that can interfere with canal function during storm events.

GENERAL LANDSCAPE BMPs

Some additional landscape BMPs are as follows:

1. Make sure the people you hire to care for your lawn, landscaping, and waterways are licensed professionals and that they are aware of the relationship between household habits and the health of natural systems.
2. Do not allow fertilizers, pesticides, lawn clippings, soil, and other landscaping materials to collect on impervious surfaces where they can be washed off into storm drains connected to canals and waterways.
3. Rinse off pesticide and fertilizer application equipment on the grass and away from impervious surfaces such as driveways or sidewalks. Be careful to minimize the likelihood of spills and runoff into storm drains and into connected canals and lakes.
4. Keep swales on your property clear to allow stormwater to flow unimpeded. Do not backfill or park on swales, and do not plant trees or shrubs in swales.

5. Property managers as well as homeowners should establish realistic, measurable outcomes for landscape BMPs, so their adoption and impact can be achieved and evaluated.
6. Educate your neighbors and homeowner associations about different types of fertilizer and the appropriate applications for South Florida.
7. Provide recognition and awards to good environmental stewards in your neighborhood and community to generate excitement and community pride regarding BMPs.

Appendix C

STRUCTURAL BMP FACT SHEETS

This appendices contains fact sheets that provide a summary for each of the structural BMP options mentioned in the document. These fact sheets are designed as quick reference guides to be used in the field.

TABLE OF CONTENTS

SFWMD-BMP-RS-1 - Retention Systems - Dry Retention Basins	C-3
SFWMD-BMP-RS-2 - Retention Systems - Exfiltration Trenches	C-5
SFWMD-BMP-RS-3 - Retention Systems - Concrete Grid Pavers	C-7
SFWMD-BMP-RS-4 - Retention Systems - Vegetated Filter Strips.....	C-9
SFWMD-BMP-RS-5 - Retention Systems - Grassed Swales.....	C-11
SFWMD-BMP-DS-1 - Detention Systems - Dry Detention Ponds.....	C-13
SFWMD-BMP-DS-2 - Detention Systems - Wet Detention Ponds	C-15
SFWMD-BMP-DS-3 - Detention Systems - Constructed Wetlands	C-17
SFWMD-BMP-OS-1 - Other Systems - Water Quality Inlets	C-19
SFWMD-BMP-OS-2 - Other Systems - Separation Devices	C-21
SFWMD-BMP-OS-3 - Other Systems - Chemical Treatment	C-23

Structural BMP Fact Sheet

SFWMD-BMP-RS-1 - Retention Systems - Dry Retention Basins

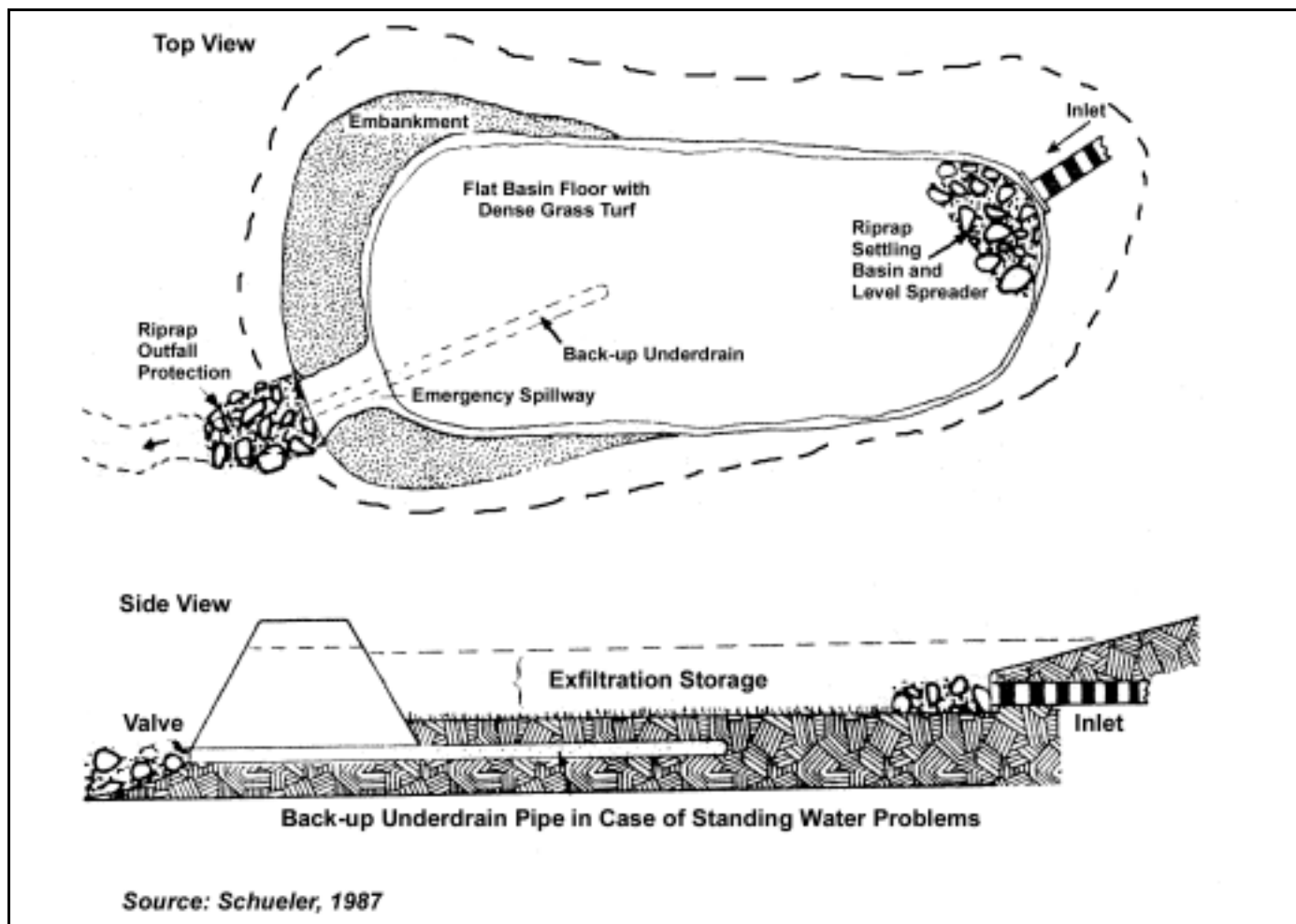

DESCRIPTION

- Dry retention basins are depressed areas where incoming urban runoff is temporarily stored until it gradually infiltrates into the surrounding soil.

SELECTION CRITERIA

- Deep permeable soils (minimum one-half inch per hour infiltration rate).
- Small drainage area.

LIMITATIONS

- May not be appropriate where ground water requires protection.
- Restrictions may apply to systems located above sole source (drinking water) aquifers.
- Long-term effectiveness in most cases will depend on proper operation and maintenance of the entire system.
- Low longevity.

DESIGN AND SIZING CONSIDERATIONS

- Require a deep layer of permeable soils at separation distances of at least 1 foot between the bottom of the structure and seasonal ground water levels.
- Runoff should gradually drain (infiltrate) down to maintain aerobic conditions that favor bacteria that aid in pollutant removal and to ensure the basin is ready to receive the next storm (check local regulations also).
- Runoff entering the basin may require pretreatment to remove coarse sediment that may clog the surface soil pore on the basin floor.

Targeted Pollutants

- Suspended Sediments
- Total Phosphorus
- Total Nitrogen
- Heavy Metals
- Oxygen Demanding Substances
- Trace Metals
- Bacteria

Implementation Requirements

- Capital Costs
- O&M Costs
- Maintenance
- Training
- High Low

- Concentrated runoff should flow through a sediment trap
- A vegetated filter strip may be used for sheetflow.
- A design safety factor of 2 is recommended.
- Side slopes of 1:4 are recommended if riding mower is to be used.
- A bottom slope of 2 percent or close to zero is recommended to maximize infiltration.
- To avoid resuspension of settled out solids, nonerosive velocities should be maintained along pond bottoms during peak runoff events.

CONSTRUCTION/INSPECTION CONSIDERATIONS

- Design soil conditions must be confirmed during excavation.
- Driving of heavy equipment over retention basin must be avoided during and after construction.
- If retention basin is used for sediment and erosion control during construction, the last one foot at basin bottom should not be excavated to final grade until the entire drainage area has been stabilized.
- After final grading, deep tilling of the infiltration area is recommended to maximize infiltration.
- Stabilize with vegetation within one week after construction.
- Basin bottom should be seeded, instead of sodded, to maximize infiltration.

MAINTENANCE REQUIREMENTS

- Facility must be inspected every 6 months or after a major storm event and any debris must be removed.
- Control structure must be inspected and maintained semiannually and repaired as needed.
- Accumulated sediments must be removed at least once annually.
- Rototilling or disking the basin bottom should be done annually.
- Embankments and side slopes must be maintained.
- Use fertilizers only if absolutely necessary.

COST CONSIDERATIONS

- Facility could have ancillary use (recreation) when dry.
- Construction ranges from \$0.50 to \$1.00 per cubic foot.
- Annual maintenance ranges from 3 to 6 percent of capital costs.

Structural BMP Fact Sheet

SFWMD-BMP-RS-2 - Retention Systems - Exfiltration Trenches

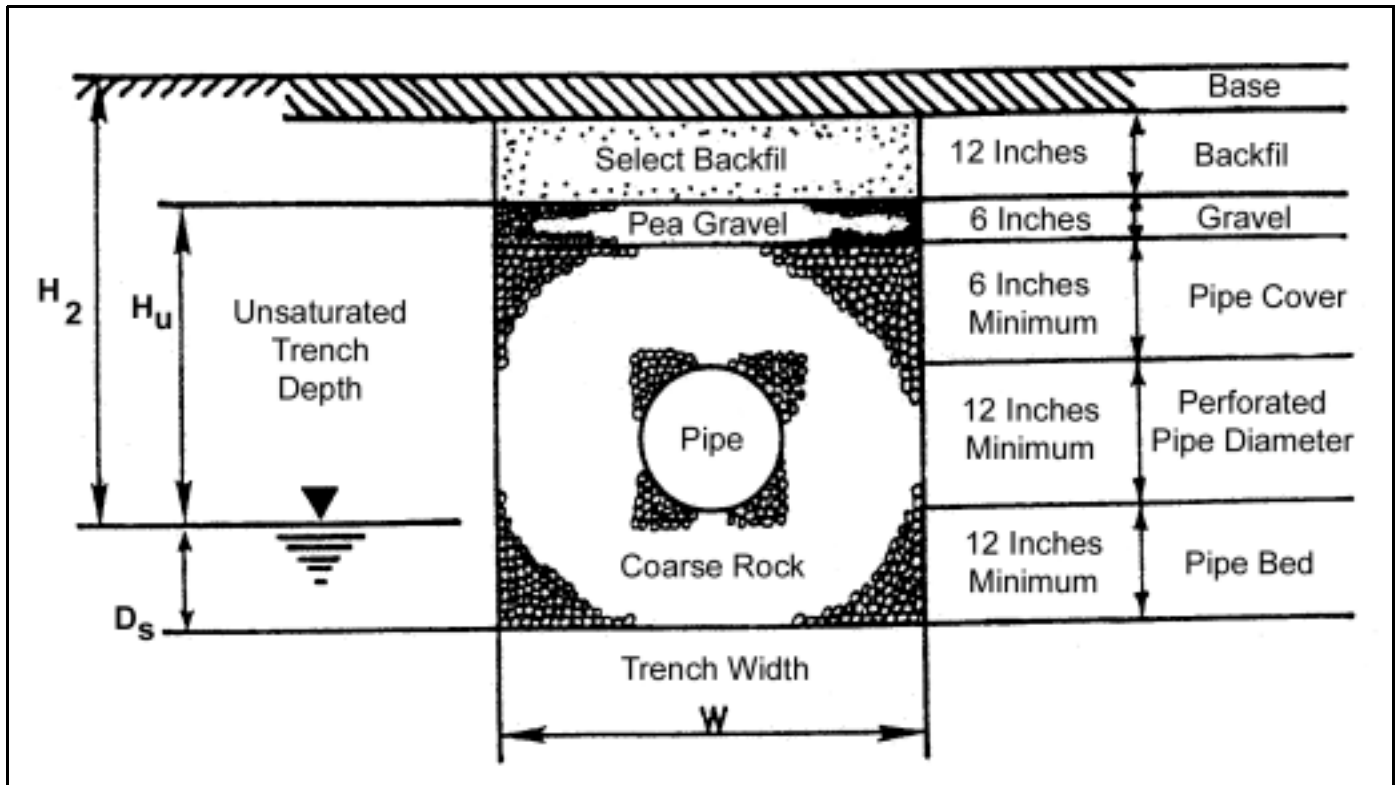

DESCRIPTION

Exfiltration trenches are perforated pipes buried in trenches that have been backfilled with stone or sand/aggregate. Urban runoff diverted into the pipe gradually infiltrates from the pipe into the trench and into the subsoil, eventually reaching the ground water.

SELECTION CRITERIA

- Recommended for high density development.
- Deep permeable soils.
- Small drainage area.

LIMITATIONS

- Provides little treatment for high flows.
- Not to be considered towards flood attenuation requirements.
- Restrictions may apply to systems located above sole source (drinking water) aquifers.
- Soil must have good infiltration rates (at least 0.5 inches per hour).
- Low longevity, high maintenance.

DESIGN AND SIZING CONSIDERATIONS

- Filter cloth is required at least around the top and sides of the trench to minimize clogging.
- Minimum trench width is 3 feet.
- Pipe must be at least 12 inches in diameter.
- Ground water table must be at or below invert of pipe.
- A safety factor of two or more should be used to allow for geological uncertainties.
- Inlets connected to the trench should be designed to have sumps.

CONSTRUCTION/INSPECTION CONSIDERATIONS

- Inlets must be covered during construction to minimize sedimentation in the trench.

Targeted Pollutants

Suspended Sediments
 Total Phosphorus
 Total Nitrogen
 Heavy Metals
 Oxygen Demanding Substances
 Trace Metals
 Bacteria

Implementation Requirements

- Capital Costs
- O&M Costs
- Maintenance
- Training
 - High
 - Low

MAINTENANCE REQUIREMENTS

- Trash, grass clippings, and other debris should be removed from the trench perimeter and disposed of properly once a year or as needed.
- Trenches must be inspected regularly and debris removed, especially after large rain events.
- Periodic repair and sediment removal is needed to facilitate exfiltration.

COST CONSIDERATIONS

- Construction costs range from \$2.50 to \$7.91 per cubic foot of treatment volume.
- Annual maintenance is 3 to 20 percent of capital costs.

Structural BMP Fact Sheet

SFWMD-BMP-RS-3 - Retention Systems - Concrete Grid Pavers

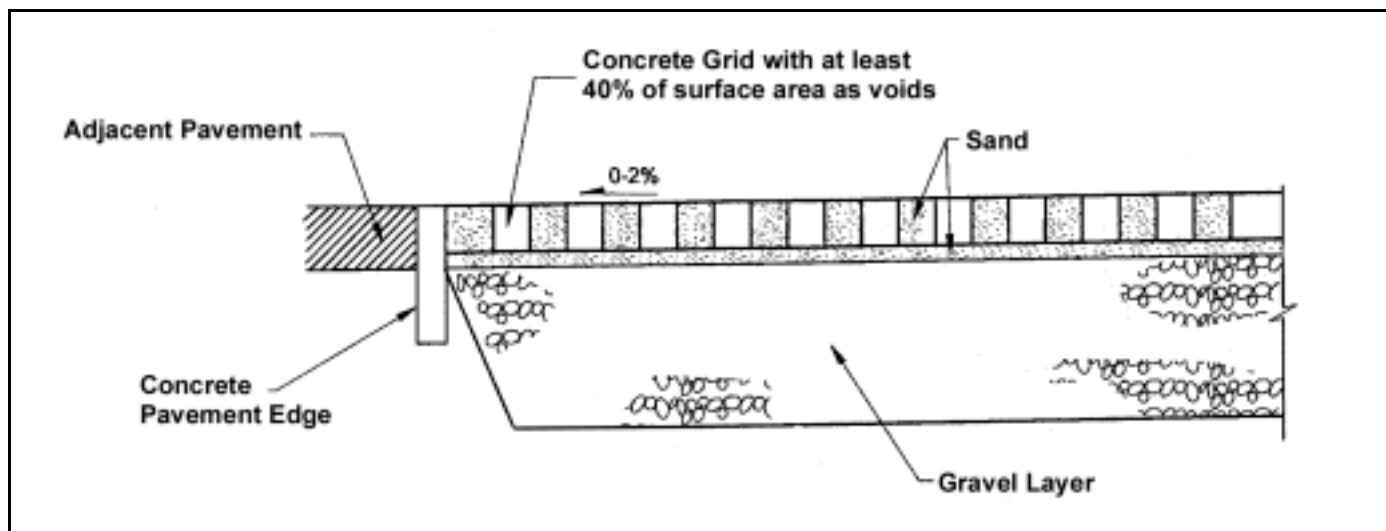

DESCRIPTION

Surfaces such as concrete or synthetic grid pavers or blocks interspersed with areas of gravel, sand, or grass serve to reduce runoff volumes and trap vehicle-generated pollutants. They provide a reinforced pervious surface for low traffic parking.

SELECTION CRITERIA

- Recommended for high density development.
- Deep permeable soils.
- Restricted traffic, such as parking or emergency vehicle access only.
- Small drainage area.

LIMITATIONS

- Provides little treatment for high flows.
- Not to be considered towards flood attenuation requirements.
- Restrictions may apply to systems located above sole source (drinking water) aquifers.
- Soil must have good infiltration rates (at least 0.5 inches per hour).

DESIGN AND SIZING CONSIDERATIONS

- Ground water table must be at least 2 feet below grade of pavement.
- To be used only in low traffic or parking areas.

CONSTRUCTION/INSPECTION CONSIDERATIONS

- Gravel layer must be protected during construction to minimize sedimentation.

MAINTENANCE REQUIREMENTS

- Trash, grass clippings, and other debris should be removed from the surface of the area as needed.
- Pavers must be inspected regularly and debris removed, especially after large rain events.
- Nutrient and pesticide management should be performed as needed.

COST CONSIDERATIONS

- Construction costs range from \$0.50 to \$2.00 per square foot.
- Annual maintenance is 5 percent of initial construction costs.

Targeted Pollutants

Implementation Requirements

- Capital Costs
 - O&M Costs
 - Maintenance
 - Training
- High ○ Low

Structural BMP Fact Sheet

SFWMD-BMP-RS-4 - Retention Systems - Vegetated Filter Strips

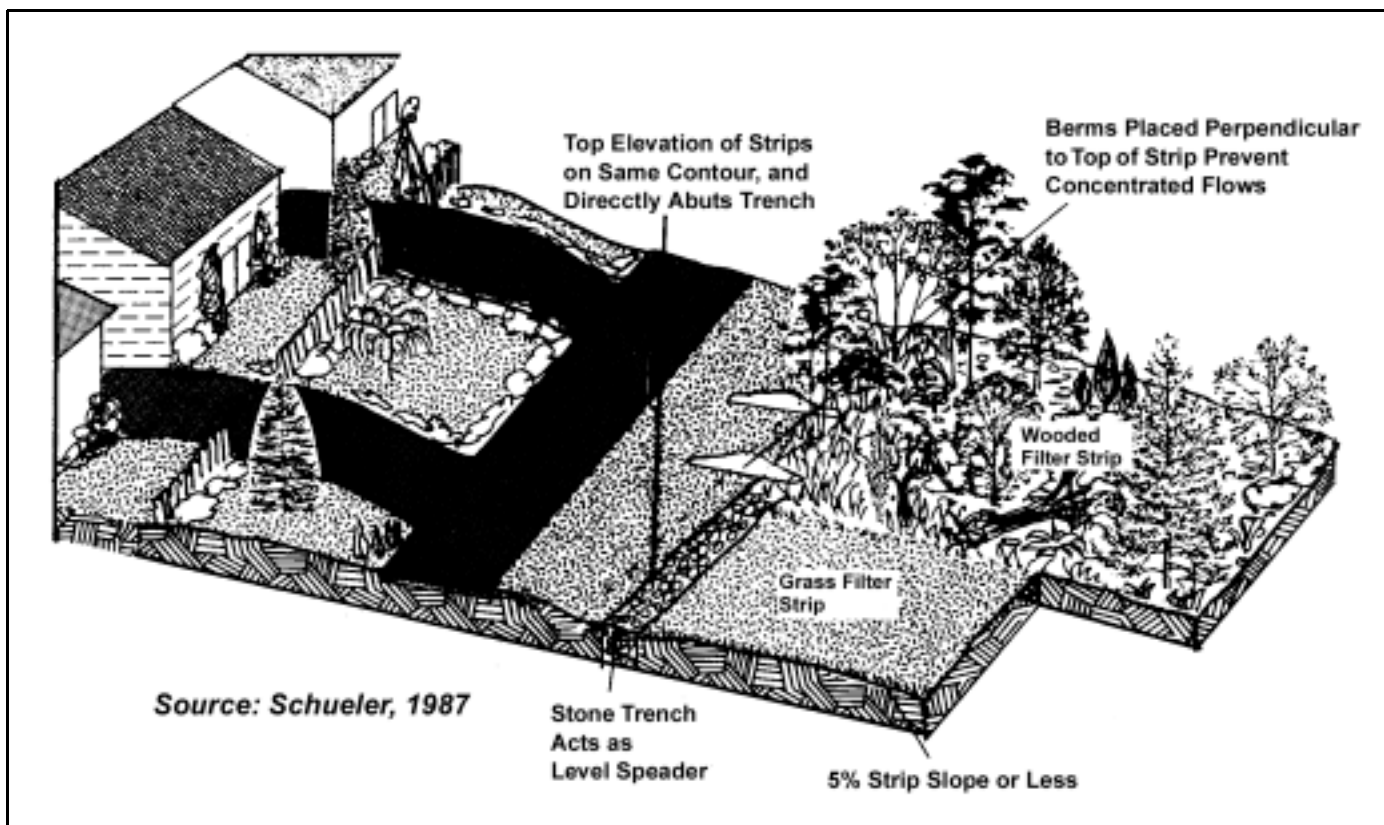

DESCRIPTION

Vegetated filter strips are strips of land with vegetated cover that are designed to reduce sediment and remove pollutants.

SELECTION CRITERIA

- Recommended for agriculture and low density development.
- Pretreatment for other structural practices, such as dry detention ponds and exfiltration trenches.
- Small drainage area.

LIMITATIONS

- Provide little treatment for concentrated flows.
- Restrictions may apply to systems located above sole source (drinking water) aquifers.
- Soil must have good infiltration rates (at least 0.5 inches per hour).

DESIGN AND SIZING CONSIDERATIONS

- Filter strip should be at least 20 feet long. Better performance can be achieved if the strip is 50 to 100 feet long.
- The grade slope should not exceed 5 percent.
- A level spreader at least as wide as the contributing overland flow area that is graded uniformly to avoid flow concentration is highly recommended.
- Seasonal ground water table must be at least 2 to 4 feet lower than the bottom of the filter strip.

CONSTRUCTION/INSPECTION CONSIDERATIONS

- Forested strips next to water bodies should be left undisturbed except for the removal of trees that present unusual hazards and small debris that may be refloat by high water.
- Top edge of the filter strip should be regraded and reseeded if strip has been used as a sediment and erosion control measure during the construction phase.

Targeted Pollutants

Suspended Sediments
 Total Phosphorus
 Total Nitrogen
 Heavy Metals
 Oxygen Demanding Substances
 Trace Metals

Implementation Requirements

- Capital Costs
 - O&M Costs
 - Maintenance
 - Training
- High ○ Low

MAINTENANCE REQUIREMENTS

- Mowing must be performed as needed, but should be limited to spring or fall to avoid impacts on ground nesting birds.
- Aeration of filter strips is required.
- Maintaining a healthy vegetation aids in removal efficiency and prevents erosion.
- Sediment buildup must be removed annually to prevent a damming effect.
- Nutrient and pesticide management should be performed as needed.
- Periodic harvesting of some trees not directly adjacent to water bodies removes sequestered nutrients and maintains an efficient filter through vigorous vegetation.
- To minimize soil compaction, vehicular traffic and excessive pedestrian traffic should be avoided.
- Periodic repair and sediment removal is needed to prevent channelization.

COST CONSIDERATIONS

- Costs are lower if existing vegetation is used.
- Construction cost ranges from \$0 to \$1.3 per square foot.
- Annual maintenance cost ranges from \$100 to \$1,400 per acre.

Structural BMP Fact Sheet

SFWMD-BMP-RS-5 - Retention Systems - Grassed Swales

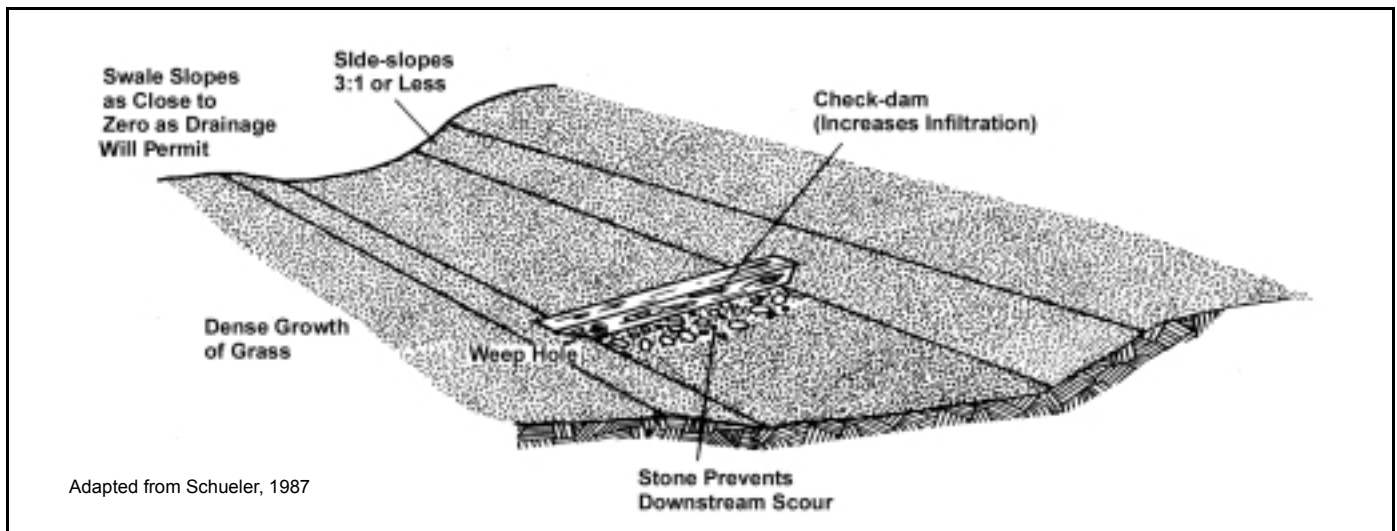

DESCRIPTION

Grassed swales are filtration and conveyance mechanisms that are generally used to provide pretreatment before runoff is discharged to treatment systems.

SELECTION CRITERIA

- Low density areas.
- Small drainage area.

LIMITATIONS

- Restrictions may apply to systems located above sole source (drinking water) aquifers.
- Long-term effectiveness in most cases will depend on proper maintenance of the entire system.
- If flows pass through rapidly and limited soil infiltration occurs, minimal pollutant removal can be expected.
- Soil must have good infiltration rates (at least 0.5 inch per hour).

DESIGN AND SIZING CONSIDERATIONS

- Swales are typically shallow, vegetated, man-made trenches with a width-to-depth ratio equal to or greater than 6 to 1, or side slopes equal to or greater than 3-feet horizontal to 1-foot vertical.
- Check dams across the flow path will increase containment of first-flush contaminants.
- If longitudinal slopes exceed 4 percent, check dams are needed.
- Flow velocities must not exceed 1.5 to 3 feet per second.
- Seasonal ground water table must be at least 2 to 4 feet lower than the bottom of the swale.

CONSTRUCTION/INSPECTION CONSIDERATIONS

- Soil should not be compacted during construction. If it is, it should be tilled.
- Swale must be stabilized with vegetation within one week after it has been graded.

MAINTENANCE REQUIREMENTS

- The established width should be maintained to ensure the continued effectiveness and capacity of the system.
- Grassed swales should be mowed to stimulate vegetative growth, control weeds, and maintain the capacity of the system (see **Appendix B** for guidelines).
- Inspections, vegetation maintenance, mowing, and debris removal are required at least annually.
- Inspect check dams for erosion at least annually.
- Sediment removal, reseeding, or resodding should be done at least every 5 years.

Targeted Pollutants

Suspended Sediments
 Total Phosphorus
 Total Nitrogen
 Heavy Metals
 Oxygen Demanding
 Substances

Implementation Requirements

- Capital Costs
- O&M Costs
- Maintenance
- Training
- High Low

- Nutrient and pesticide management should be performed as needed.
- Residents that have swales must be educated on their maintenance requirements.

COST CONSIDERATIONS

- Construction cost ranges from \$0.60 to \$1.60 per square foot.
- Annual maintenance cost ranges from 5 to 7 percent of capital costs.

Structural BMP Fact Sheet

SFWMD-BMP-DS-1 - Detention Systems - Dry Detention Ponds

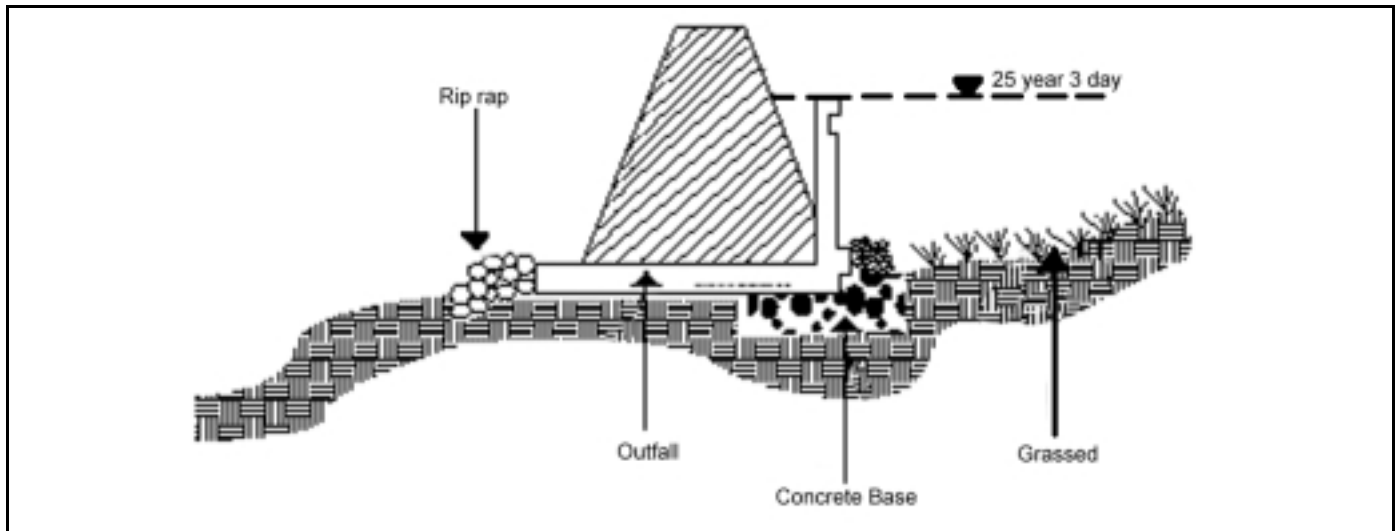

DESCRIPTION

Dry detention ponds are depressed green areas where urban runoff is temporarily stored, then gradually released through a control structure or by filtration into the ground

SELECTION CRITERIA

- Moderately permeable soils.
- Moderate to large amount of open area available.
- Moderate to large drainage area.

LIMITATIONS

- May not be appropriate where ground water requires protection.
- Restrictions may apply to systems located above sole source (drinking water) aquifers.
- Long-term effectiveness in most cases will depend on proper operation and maintenance of the entire system.
- Moderate longevity.

DESIGN AND SIZING CONSIDERATIONS

- Requires a moderate layer of permeable soil at separation distances of at least 1 foot between the bottom of the structure and seasonal ground water levels.
- Runoff should gradually drain down and/or infiltrate to maintain aerobic conditions favoring bacteria that aid in pollutant removal and to ensure the basin storage capacity is available for subsequent storm events (check local regulations also).
- Concentrated runoff should flow through a sediment trap.
- A vegetated filter strip may be used for sheetflow.
- Side slopes of 1:4 are recommended if riding mower is to be used.
- A bottom slope of 1 percent is recommended to maximize infiltration and avoid ponding.
- To avoid resuspension of settled out solids, nonerosive velocities should be maintained along the pond bottom during peak runoff events.

CONSTRUCTION/INSPECTION CONSIDERATIONS

- Design soil conditions must be confirmed during excavation.
- Driving of heavy equipment over a detention basin must be avoided during and after construction.
- If a detention basin is used for sediment and erosion control during construction, the last foot at the basin bottom should not be excavated to final grade until entire drainage area has been stabilized.
- After final grading, deep till of infiltration area is recommended to maximize infiltration.
- Stabilize with vegetation within three days after construction.
- Basin bottom should be seeded, instead of sodded, to maximize infiltration.

Targeted Pollutants

Suspended Sediments
 Total Phosphorus
 Total Nitrogen
 Heavy Metals
 Oxygen Demanding Substances
 Trace Metals

Implementation Requirements

- Capital Costs
- O&M Costs
- Maintenance
- Training
- High ○ Low

MAINTENANCE REQUIREMENTS

- Facility must be inspected every 6 months or after a major storm event and any debris must be removed.
- Control structure must be inspected and maintained semiannually, and repaired as needed.
- Accumulated sediments must be removed at least once annually.
- Rototilling or disking the basin bottom should be done annually.
- Embankments and side slopes must be maintained.
- Use fertilizers only if absolutely necessary.

COST CONSIDERATIONS

- Construction cost ranges from \$0.50 to \$1.00 per cubic foot.
- Annual maintenance cost ranges from 1 to 5 percent of capital costs.

Structural BMP Fact Sheet

SFWMD-BMP-DS-2 - Detention Systems - Wet Detention Ponds

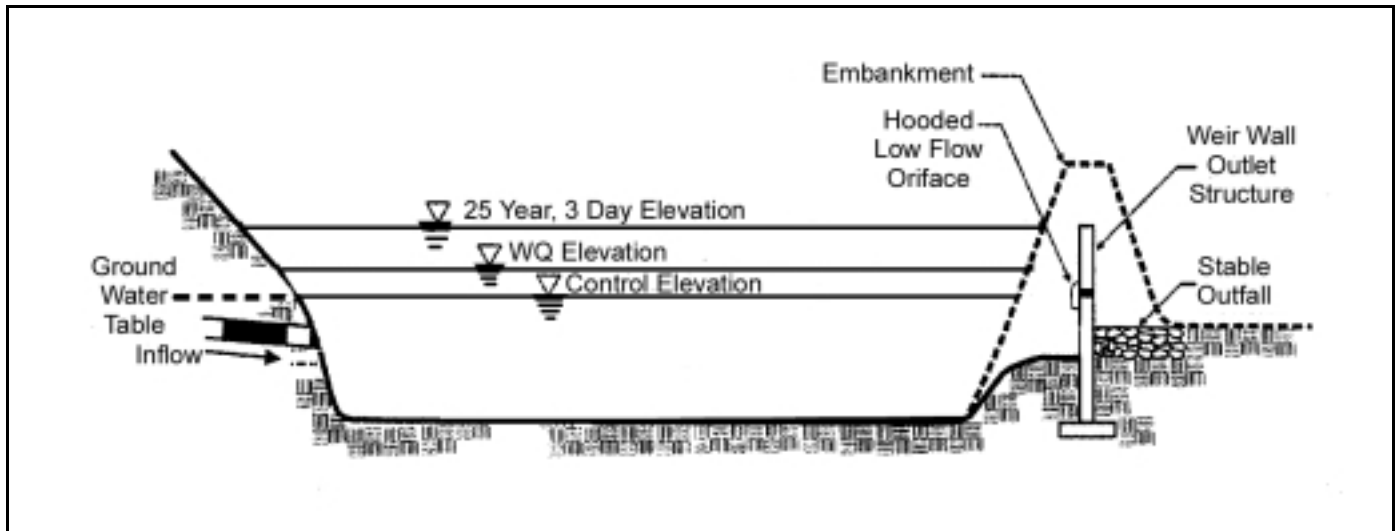

DESCRIPTION

Wet detention basins are pond areas maintained at a control elevation where urban runoff is temporarily stored, then gradually released through a control structure.

SELECTION CRITERIA

- Low to moderately permeable soils acceptable.
- Moderate to large amount of open area available.
- Moderate to large drainage area.

LIMITATIONS

- May not be appropriate where ground water requires protection.
- Restrictions may apply to systems located above sole source (drinking water) aquifers.
- Long-term effectiveness in most cases will depend on proper operation and maintenance of the entire system.
- Moderate longevity.

DESIGN AND SIZING CONSIDERATIONS

- Concentrated runoff should flow through a sediment trap or dry detention/retention area upstream of a wet detention pond.
- A vegetated filter strip may be used for sheetflow.
- Side slopes of 1:4 or less are recommended if riding mower is to be used.
- To avoid resuspension of settled out solids, nonerosive velocities should be maintained along the pond bottom during peak runoff events.

CONSTRUCTION/INSPECTION CONSIDERATIONS

- Design soil conditions must be confirmed during excavation.
- Stabilize slopes with vegetation within three days after construction.

MAINTENANCE REQUIREMENTS

- Facility must be inspected every six months or after a major storm event and any debris must be removed.
- Control structure must be inspected and maintained semiannually, and repaired as needed.
- Accumulated sediments must be removed every five years.
- Embankments and side slopes must be maintained and repaired as needed.
- Use fertilizers only if absolutely necessary.

COST CONSIDERATIONS

- Construction cost ranges from \$0.50 to \$1.00 per cubic foot.
- Annual maintenance cost ranges from 3 to 5 percent of capital costs.

Targeted Pollutants

Suspended Sediments
 Total Phosphorus
 Total Nitrogen
 Heavy Metals
 Oxygen Demanding Substances
 Trace Metals

Implementation Requirements

- Capital Costs
 - O&M Costs
 - Maintenance
 - Training
- High ○ Low

Structural BMP Fact Sheet

SFWMD-BMP-DS-3 - Detention Systems - Constructed Wetlands

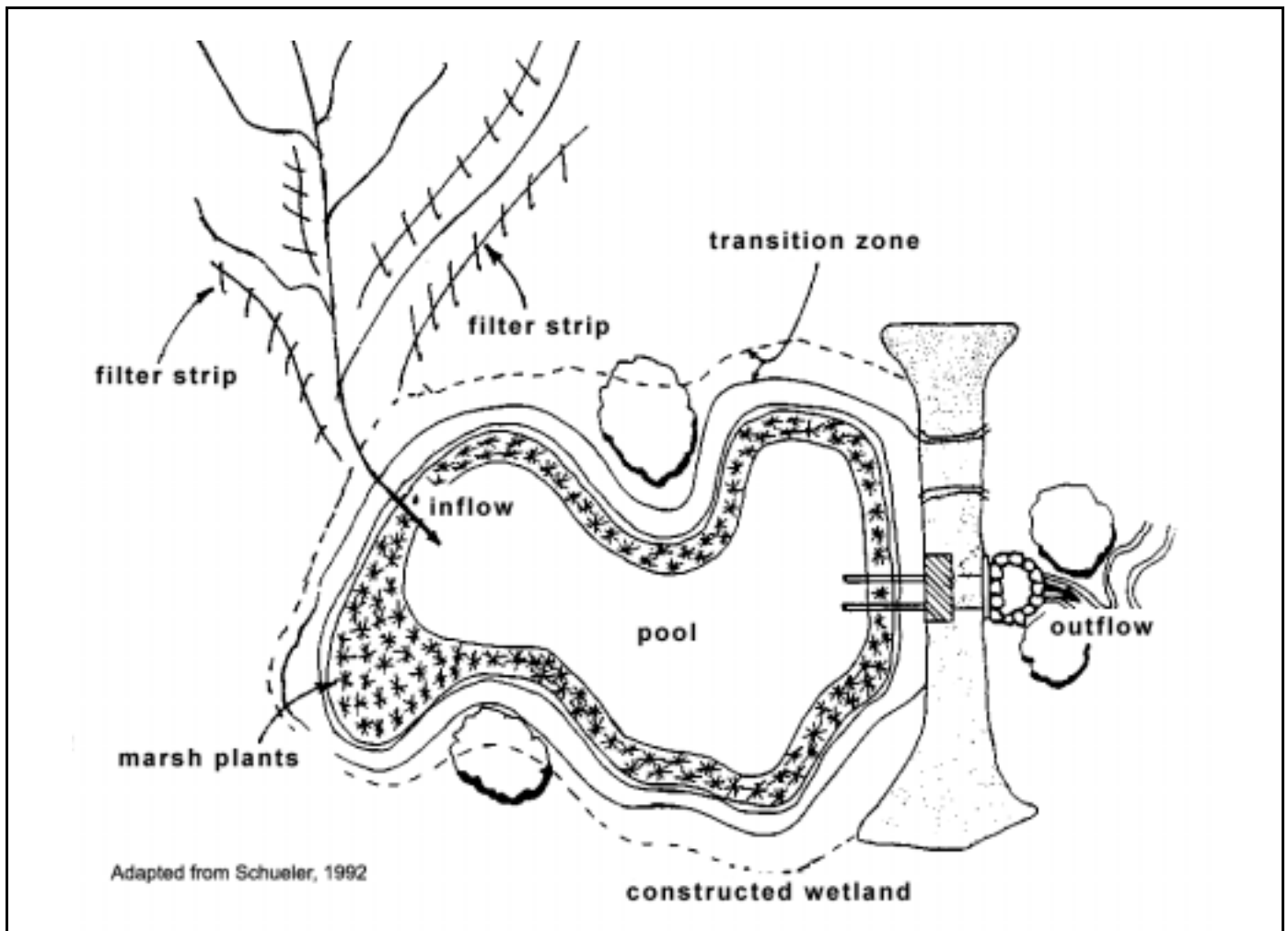

DESCRIPTION

Constructed wetlands and multiple pond systems treat runoff through adsorption, plant uptake, filtration, volatilization, precipitation, and microbial decomposition. They are designed to simulate the water quality improvement functions of natural wetlands to treat and contain surface water runoff pollutants and decrease loadings.

SELECTION CRITERIA

- Moderate to large drainage area.
- Shallow surface water table.
- Optimal water depth is approximately 6 inches.
- Poorly drained organic soils.

LIMITATIONS

- Potential augmentation of water flows.
- Seasonal variability of plant growth.
- Potential breeding grounds for insects and undesirable odors.
- Maintenance is required for efficiency.
- Potential increase of thermal discharge, oxygen demand, and net nutrient loading.

DESIGN AND SIZING CONSIDERATIONS

- An area consisting of at least 2 to 3 percent of the total contributing watershed's area will be needed.
- Multiple pond systems potentially provide much higher levels of treatment.

Targeted Pollutants

Suspended Sediments
 Total Phosphorus
 Total Nitrogen
 Heavy Metals
 Chemical Oxygen Demanding Substances
 Trace Metals

Implementation Requirements

- Capital Costs
 - O&M Costs
 - Maintenance
 - Training
- High ○ Low

- Vegetated buffers and deep water areas (approximately 25 percent) provide additional treatment, wildlife habitat, and aesthetic enhancements.
- Maximized flow paths via buffers, stands, and peninsulas increase treatment area.
- Bottom bleed down device facilitates dewatering for maintenance.

CONSTRUCTION/INSPECTION CONSIDERATIONS

- Retain or augment organic soils to improve performance.
- Include a plant specialist for design, construction, and maintenance plans.
- Schedule slope stability, construction, and landscaping to coincide with seasonal plant growth.
- Inspect plant communities, sediment accumulations, and discharge structures annually.

MAINTENANCE REQUIREMENTS

- Slope control and removal of sediment in forebays.
- Removal of trash, debris, and nuisance species.
- Supplemental plantings.

COST CONSIDERATIONS

- Construction cost ranges from \$0.05 to \$1.00 per cubic foot.
- Maintenance cost ranges from 1 to 5 percent of capital costs.

Structural BMP Fact Sheet

SFWMD-BMP-OS-1 - Other Systems - Water Quality Inlets

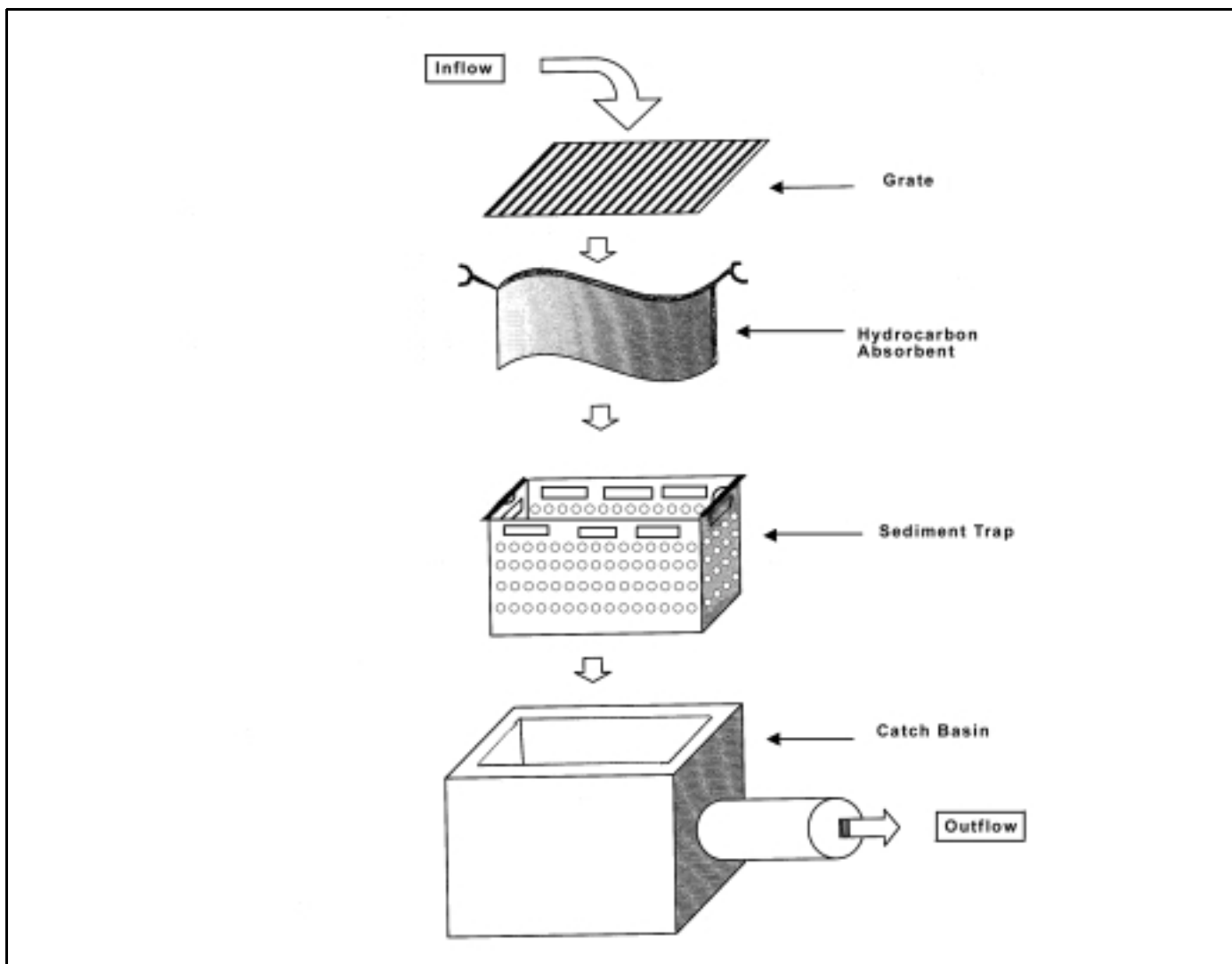

DESCRIPTION

Water quality inlets rely on settling to remove pollutants before discharging water to the storm sewer or other collection system. They are also designed to trap floating trash and debris. When inlets are coupled with oil/grit separators and/or hydrocarbon absorbents, hydrocarbon loadings from high traffic parking areas may be reduced.

SELECTION CRITERIA

- Applicable to many sites, including high density areas with poorly drained soils and extensive impermeable areas.
- Small drainage area.
- Flexibility to retrofit existing drainage areas with minimal or no additional land requirement.

LIMITATIONS

- Pollutant removal effectiveness is limited, and the devices should be used only when coupled with extensive clean-out methods.
- Not effective for water quality control during intensive storms.

DESIGN AND SIZING CONSIDERATIONS

- Retrofitting devices can be install in any shape or size of grate or cub inlet. Accurate measurement of inlets must be taken to ensure proper fit.

Targeted Pollutants

Suspended Sediments

Implementation Requirements

- Capital Costs
- O&M Costs
- Maintenance
- Training
- High Low

- Should not obstruct flow or cause excessive hydraulic head losses.
- Need removable grates or manholes to install and clean devices.

CONSTRUCTION/INSPECTION CONSIDERATIONS

- Frequent periodic inspections and sediment removal are required (2 to 3 times per year).

MAINTENANCE REQUIREMENTS

- Proper disposal of trapped coarse-grained sediments and hydrocarbons is required.
- Clean-out and disposal costs may be significant.
- Maintenance requirements are high if clean out of sediment and debris is performed routinely.
- Requires replacement of hydrocarbon absorbent at least once per year.

COST CONSIDERATIONS

- Construction cost ranges from \$1,100 to \$3,000 per new precast unit and from \$600 to \$900 per retrofitted unit.
- Annual maintenance cost ranges from \$7.50 to \$90 per unit.
- Hydrocarbon absorbent costs approximately \$100.

Structural BMP Fact Sheet

SFWMD-BMP-OS-2 - Other Systems - Separation Devices

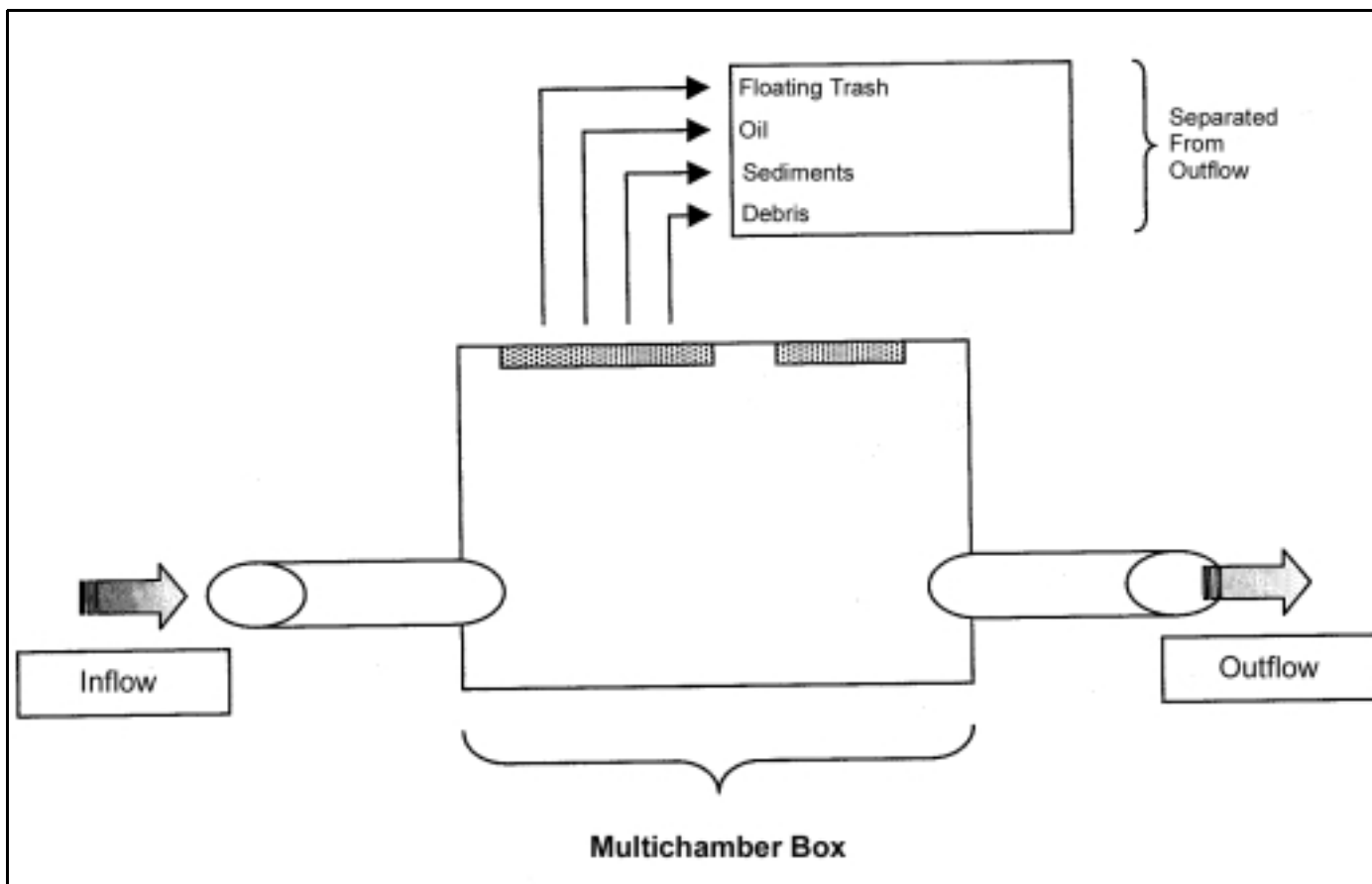

DESCRIPTION

Separation devices include sumps, baffle boxes, oil/grit separators, and sediment basins to capture trash, sediments, and floating debris.

SELECTION CRITERIA

- Applicable to many sites, including high density areas with poorly drained soils and extensive impermeable areas.
- Small drainage area.
- Flexibility to retrofit existing drainage areas with minimal or no additional land requirement.

LIMITATIONS

- Efficient only within specific ranges of volume and discharge rates.

DESIGN AND SIZING CONSIDERATIONS

- A forebay can pretreat discharges by separating heavy grit and floating debris before it enters the separator.
- A manhole cover over each chamber is recommended for easy access and inspection.

CONSTRUCTION/INSPECTION CONSIDERATIONS

- Frequent periodic inspections and sediment removal are required (1 to 3 times per year).

MAINTENANCE REQUIREMENTS

- Period inspections and sediment removal are required
- Proper disposal of trapped coarse-grained sediments is required.
- Clean-out and disposal costs may be significant.

Targeted Pollutants

Suspended Sediments

Implementation Requirements

- Capital Costs
- O&M Costs
- Maintenance
- Training
- High ○ Low

- Maintenance requirements are high if clean out of sediment and debris is performed routinely.

COST CONSIDERATIONS

- These devices may have a high initial investment cost.
- Construction cost ranges from \$2,300 to \$40,000 per unit.
- Annual maintenance cost is less than \$1,000 per unit.

Structural BMP Fact Sheet

SFWMD-BMP-OS-3 - Other Systems - Chemical Treatment

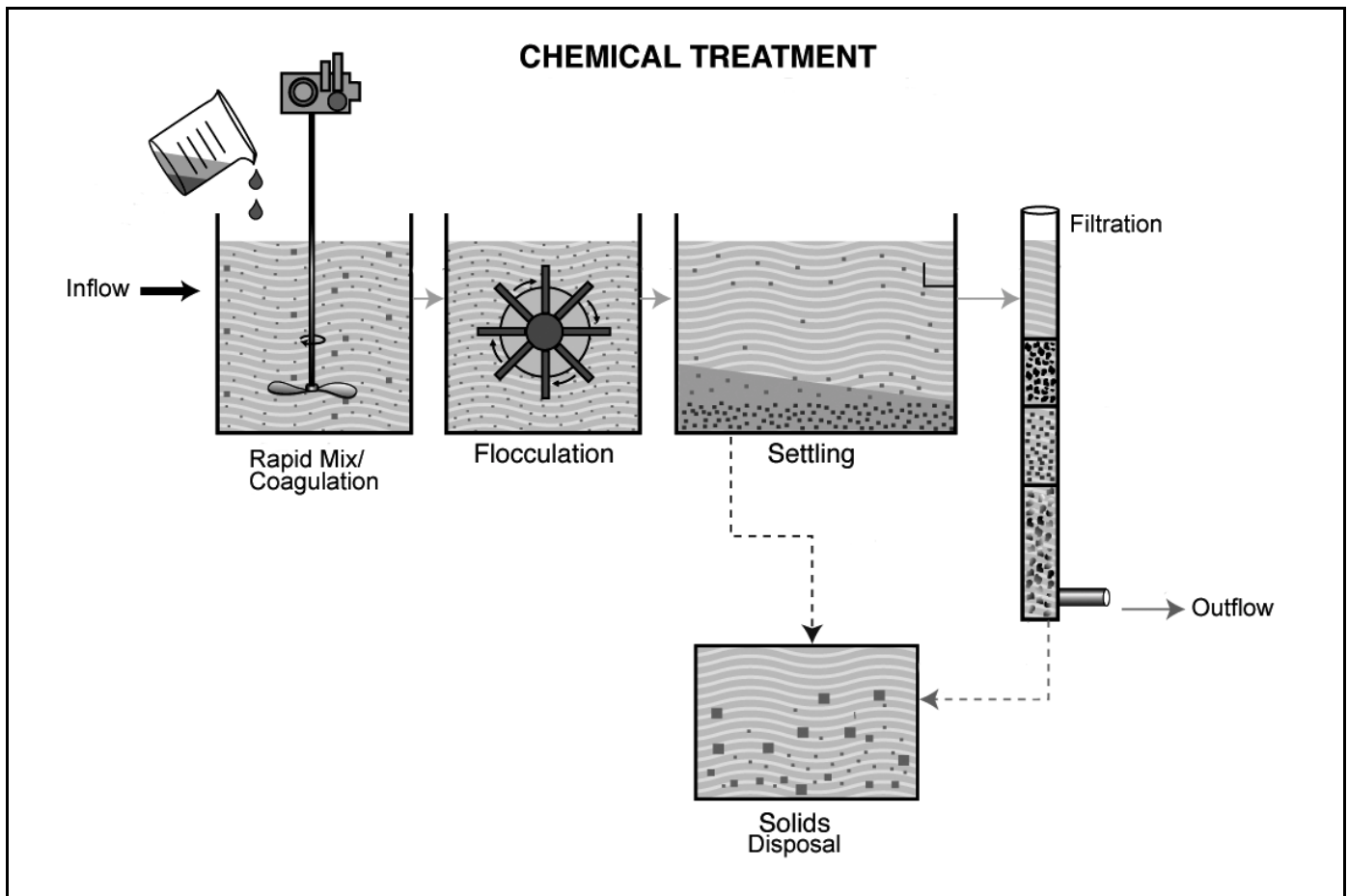

DESCRIPTION

Chemical processes include coagulation coupled with solids separation to remove pollutants. Iron, aluminum metal salts, and alum are used to coagulate compounds, then polymers are added to enhance flocculation and induce settling. Chemical processes offer the advantage of low land requirements, flexibility, reliability, decreased detention time requirements, and the ability to enhance water quality to levels substantially lower than could be achieved using other methods alone.

SELECTION CRITERIA

- Applicable to many sites, including high density areas with poorly drained soils and extensive impermeable areas.
- Moderate to large drainage area.

LIMITATIONS

- High capital, operations, and maintenance costs.
- Solid waste management requirements.

DESIGN AND SIZING CONSIDERATIONS

- Needs relatively steady flow, flow equalization basin, or storage.
- The accumulated floc is normally sent to a landfill, but some systems allow for automatic floc disposal into the sanitary sewer or adjacent drying beds.

CONSTRUCTION/INSPECTION CONSIDERATIONS

- Availability of suitable site including discharge buffer zone.

Targeted Pollutants

Suspended Sediments
Total Phosphorus

Implementation Requirements

- Capital Costs
- O&M Costs
- Maintenance
- Training

● High ○ Low

MAINTENANCE REQUIREMENTS

- Maintenance is high if chemicals are continually input and spent precipitate is removed.
- Accumulated alum floc must be pumped out of the sump area on a periodic basis.

COST CONSIDERATIONS

- Average construction cost is \$790 per acre treated.
- Annual operation and maintenance cost is \$100 per acre of drainage area served.
- Cost of land required at installation location.