



Online Continuing Education for Professional Engineers
Since 2009

Standard Practices for Shotcrete (Spray Concrete)

PDH Credits:

6 PDH

Course No.:

SCP101

Publication Source:

US Army Corps of Engineers "Standard Practice for Shotcrete"

Engineering and Design
Engineer Manual No. 1110-2-2005

Release Date:

Jan. 1993

DISCLAIMER:

All course materials available on this website are not to be construed as a representation or warranty on the part of Online-PDH, or other persons and/or organizations named herein. All course literature is for reference purposes only, and should not be used as a substitute for competent, professional engineering council. Use or application of any information herein, should be done so at the discretion of a licensed professional engineer in that given field of expertise. Any person(s) making use of this information, herein, does so at their own risk and assumes any and all liabilities arising therefrom.

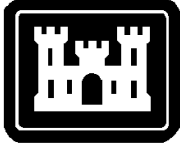

EM 1110-2-2005
31 January 1993

**US Army Corps
of Engineers**

ENGINEERING AND DESIGN

Standard Practice for Shotcrete

ENGINEER MANUAL

DEPARTMENT OF THE ARMY
US Army Corps of Engineers
Washington, DC 20314-1000

EM 1110-2-2005

CECW-EG

Engineer Manual
No. 1110-2-2005

31 January 1993

Engineering and Design
STANDARD PRACTICE FOR SHOTCRETE

- 1. Purpose.** This manual provides information and guidance on the selection, proportioning, and application of shotcrete as a construction material.
- 2. Applicability.** This manual applies to all HQUSACE/OCE elements, major subordinate commands, districts, laboratories, and field operating activities (FOA) having civil works responsibilities.
- 3. Discussion.** This manual describes general construction procedures using shotcrete. It includes both the dry-mix process, in which most of the mixing water is added at the nozzle and the wet-mix process, in which all of the materials are mixed before entering the delivery hose. Additional information on concrete properties and mixing proportioning are available in EM 1110-2-2000, "Standard Practice for Concrete."

FOR THE COMMANDER:



WILLIAM D. BROWN
Colonel, Corps of Engineers
Chief of Staff

CECW-EG

Engineer Manual
 No. 1110-2-2005

31 January 1993

**Engineering and Design
 STANDARD PRACTICE FOR SHOTCRETE**

Table of Contents

Subject	Paragraph	Page	Subject	Paragraph	Page
Chapter 1			Chapter 4		
Introduction			Equipment and Crew		
Purpose	1-1	1-1	General Equipment	4-1	4-1
Applicability	1-2	1-1	Dry-Mix Process	4-2	4-1
References	1-3	1-1	Wet-Mix Process	4-3	4-1
Glossary	1-4	1-1	Auxiliary Equipment	4-4	4-1
Background	1-5	1-1	Special Equipment	4-5	4-7
Activities and Documentation	1-6	1-1	Crew Composition	4-6	4-7
Point of Contact	1-7	1-2			
Chapter 2			Chapter 5		
Types of Shotcrete and Applications			Preconstruction Testing and Evaluation		
Why Shotcrete	2-1	2-1	General	5-1	5-1
Applications	2-2	2-1	Nozzleman Certification	5-2	5-1
Shotcrete Processes	2-3	2-2	Mixture Proportioning Evaluation . . .	5-3	5-1
Fiber-Reinforced Shotcrete	2-4	2-4	Preconstruction Demonstration and		
Silica-Fume Shotcrete	2-5	2-4	Testing	5-4	5-1
Polymer-Modified Shotcrete	2-6	2-4	Alternate Considerations	5-5	5-6
Accelerated Shotcrete	2-7	2-5			
Chapter 3			Chapter 6		
Materials, Proportioning, and Properties			Placement		
Cementitious Materials	3-1	3-1	Preparations	6-1	6-1
Aggregate	3-2	3-2	Batching and Mixing	6-2	6-2
Water	3-3	3-2	Shotcrete Application		
Chemical Admixtures	3-4	3-2	Techniques	6-3	6-3
Reinforcing Steel	3-5	3-3	Rebound	6-4	6-8
Fiber Reinforcement	3-6	3-4	Finishing	6-5	6-8
Proportioning Shotcrete	3-7	3-4	Curing and Protection	6-6	6-9
Properties of Shotcrete	3-8	3-6	Repair of Surface Defects	6-7	6-9

Subject	Paragraph	Page	Appendices
Chapter 7			Appendix A
Quality Control			References
General Considerations	7-1	7-1	
Preproduction Phase	7-2	7-1	Appendix B
Production Phase	7-3	7-2	Glossary
Corrective Actions	7-4	7-4	
Chapter 8			Appendix C
Quality Assurance			Corps of Engineers Projects
General Considerations	8-1	8-1	
Preproduction Phase	8-2	8-1	Appendix D
Production Phase	8-3	8-1	Mixture Proportioning Sample
			Submittal

Chapter 1 Introduction

1-1. Purpose

This manual provides information and guidance on the selection, proportioning, and application of shotcrete. It is intended for use by engineers and technical staff tasked with the planning, design, contract preparation, and construction management phases of a shotcrete project. A quality assurance chapter is included which details necessary technical activities during the construction phase. Subjects discussed include shotcrete and applications, materials, equipment and crew, preconstruction testing and evaluation, placement, quality control, and quality assurance. This manual does not provide guidelines for structural analysis of shotcrete applications. Refer to EM 1110-2-2000 for additional general guidance on concrete.

1-2. Applicability

This manual is applicable to all HQUSACE/OCE elements, major subordinate commands, districts, laboratories, and field operating activities (FOA) having civil works responsibilities.

1-3. References

Appendix A consists of a list of cited references that appear in the body of the text as well as a selected bibliography pertaining to the use of shotcrete. The reader is encouraged to study applicable references to supplement the guidance provided by this manual. In particular, the reader is encouraged to refer to American Concrete Institute (ACI) Committee Report 506R-90, "Guide to Shotcrete" (paragraph A-1, ACI (1991d)), and other ACI 506 documents (paragraph A-1, ACI (1991e), paragraph A-2, ACI (1991c and 1991d)).

1-4. Glossary

Appendix B consists of definitions of terms commonly used in shotcrete.

1-5. Background

a. Special equipment and techniques. Equipment for pneumatically applying a fine aggregate cement mixture was first introduced in 1910. Since that time, many improvements have been made in the equipment and in the specialized techniques required for application of

pneumatically applied mortar or concrete. The wide acceptance of shotcrete for slope and surface protection, swimming pool construction, tunnel lining, special architectural features, and renovating existing structures has resulted in the availability of a wide variety of manufactured pneumatic placement equipment.

b. Shotcrete denotes various mixtures. Shotcrete has been referred to by such terms as Gunitite, formerly a tradename for pneumatically applied mortar or concrete, sprayed concrete, spraycrete, air-blown mortar and concrete, gunned concrete, and others. In some areas "gunitite" has been used to denote small-aggregate shotcrete and mortar mixtures, and "shotcrete" to denote large-aggregate mixtures. The preferred term today for all gunned material is shotcrete, regardless of the aggregate size.

c. Specialty shotcretes. While most shotcrete placed is the traditional dry-mix and wet-mix shotcrete, the use of specialty shotcretes has become common. The addition of accelerators, fibers, and silica fume can provide shotcrete with significantly enhanced performance.

d. Varied applications. Typical applications for Corps of Engineers (Corps) projects further discussed in Chapter 2 include slope protection and stabilization, temporary excavation protection, tunnel support, and various structural and remedial applications. Appendix C provides a listing of some Corps projects that have used shotcrete for various applications.

1-6. Activities and Documentation

Involvement in shotcrete activities ranges from preliminary planning studies through the engineering and design phases, preparation of contract documents, to construction management. During these activities the engineer or other professional must perform investigations, prepare documents, and review design requirements. These activities often result in the production of the following documents:

- Shotcrete Investigation Report
- Technical Specifications
- Engineering Considerations and Instructions for Field Personnel

a. Shotcrete investigation report. The information listed is to be included in a shotcrete investigation report and prepared either as a separate report or part of a design memorandum, as a preparatory step to the

EM 1110-2-2005
31 Jan 93

production of technical specifications. The formalization of such a report depends on the size and complexity of the shotcrete project.

(1) Shotcrete quantity to be used and quality required.

(2) Climatic and service conditions to which the shotcrete will be subjected.

(3) Types of shotcrete processes and delivery equipment to be used.

(4) Types, kinds, and sources of cementitious materials to be specified, including special requirements.

(5) Potential aggregate sources, quality, and constituents.

(6) Grading of aggregate to be specified.

(7) Types and kinds of admixtures to be specified, including test requirements.

b. Technical specifications. Civil Works Guide Specification CW 03361 provides a basis for preparation of a specification for shotcrete.

c. Engineering considerations and instruction for field personnel. In accordance with EM 1110-2-2000, the designer should provide explanation of the intent of the shotcrete application, special precautions, critical items to monitor, and any other information that may be beneficial to the field staff.

1-7. Point of Contact

Questions or discussion concerning this manual should be directed through Headquarters, US Army Corps of Engineers, ATTN: CECW-EG.

Chapter 2 Types of Shotcrete and Applications

2-1. Why Shotcrete

a. Importance of proper application. Properly applied shotcrete is a structurally sound and durable construction material which exhibits excellent bonding characteristics to existing concrete, rock, steel, and many other materials. It can have high strength, low absorption, good resistance to weathering, and resistance to some forms of chemical attack. Many of the physical properties of sound shotcrete are comparable or superior to those of conventional concrete or mortar having the same composition. Improperly applied shotcrete may create conditions much worse than the untreated condition.

b. Advantages of shotcrete. Shotcrete is used in lieu of conventional concrete, in most instances, for reasons of cost or convenience. Shotcrete is advantageous in situations when formwork is cost prohibitive or impractical and where forms can be reduced or eliminated, access to the work area is difficult, thin layers or variable thicknesses are required, or normal casting techniques cannot be employed. Additional savings are possible because shotcrete requires only a small, portable plant for manufacture and placement. Shotcreting operations can often be accomplished in areas of limited access to make repairs to structures.

c. Strength of bonding. The excellent bonding of shotcrete to other materials is often an important design consideration. The force of the impact of this pneumatically propelled material on the surface causes compaction of the shotcrete paste matrix into the fine surface irregularities and results in good adhesion to the surface. Within limits, the material is capable of supporting itself in vertical or overhead applications.

2-2. Applications

The selection of shotcrete for a particular application should be based on knowledge, experience, and a careful study of required and achievable material performance. The success of the shotcrete for that application is contingent upon proper planning and supervision, plus the skill and continuous attention provided by the shotcrete applicator. The following paragraphs discuss

the use of shotcrete in several of the more common applications. A number of shotcrete applications by the Corps of Engineers are listed in Appendix C.

a. Repair. Shotcrete can be used to repair the damaged surface of concrete, wood, or steel structures provided there is access to the surface needing repair. The following examples indicate a few ways in which shotcrete can be used in repairs:

(1) Bridges. Shotcrete repair can be used for bridge deck rehabilitation, but it has generally been uneconomical for major full-thickness repairs. It is very useful, however, for beam repairs of variable depths, caps, columns, abutments, wingwalls, and underdecks from the standpoint of technique and cost.

(2) Buildings. In building repairs, shotcrete is commonly used for repair of fire and earthquake damage and deterioration, strengthening walls, and encasing structural steel for fireproofing. The repair of structural members such as beams, columns, and connections is common for structures damaged by an earthquake.

(3) Marine structures. Damage to marine structures can result from deterioration of the concrete and of the reinforcement. Damaging conditions are corrosion of the steel, freezing and thawing action, impact loading, structural distress, physical abrasion from the action of waves, sand, gravel, and floating ice, and chemical attack due to sulfates. These problems can occur in most marine structures such as bridge decks, piles, pile caps, beams, piers, navigation locks, guide walls, dams, powerhouses, and discharge tunnels. In many cases, shotcrete can be used to repair the deteriorated surfaces of these structures.

(4) Spillway surfaces. Surfaces subject to high-velocity flows may be damaged by cavitation erosion or abrasion erosion. Shotcrete repairs are advantageous because of the relatively short outage necessary to complete the repairs.

b. Underground excavations. For the most part, shotcrete is used in underground excavations in rock; but on occasion, it has been successfully used in the advancement of tunnels through altered, cohesionless, and loose soils. Typical underground shotcrete applications range from supplementing or replacing conventional support materials such as lagging and steel sets, sealing rock surfaces, channeling water flows, and installing temporary support and permanent linings.

c. Slope and surface protection. Shotcrete is often used for temporary protection of exposed rock surfaces that will deteriorate when exposed to air. Shotcrete is also used to permanently cover slopes or cuts that may erode in time or otherwise deteriorate. Slope protection should be properly drained to prevent damage from excessive uplift pressure. Application of shotcrete to the surface of landfills and other waste areas is beneficial to prevent surface water infiltration.

d. New structures. Shotcrete is not necessarily the fastest method of placing concrete on all jobs, but where thin sections and large areas are involved, shotcreting can be used effectively to save time. The following paragraphs describe some of the applications involved with construction of new structures.

(1) Pools and tanks. Shotcrete has been used extensively to construct concrete swimming pools. More recently, large aquariums have been constructed using shotcrete.

(2) Shotcrete floors and walls. Shotcrete floors in tanks and pools on well compacted subbase or on undisturbed earth have generally given excellent service. Vertical and overhead construction for walls, slabs, columns, and other structural members has been frequently shotcreted.

(3) Shotcrete domes. Construction techniques using inflatable air-forming systems have made the construction of shotcrete shells or domes practical. These large structures have been used for residential housing, warehousing, bridge, and culvert applications.

2-3. Shotcrete Processes

Shotcrete can be applied by two distinct application techniques, the dry-mix process and the wet-mix process.

a. Dry-mix shotcrete. The cementitious material and aggregate are thoroughly mixed and either bagged in a dry condition, or mixed and delivered directly to the gun. The mixture is normally fed to a pneumatically operated gun which delivers a continuous flow of material through the delivery hose to the nozzle. The interior of the nozzle is fitted with a water ring which uniformly injects water into the mixture as it is being discharged from the nozzle and propelled against the receiving surface.

b. Wet-mix shotcrete. The cementitious material, aggregate, water, and admixtures are thoroughly mixed as would be done for conventional concrete. The mixed material is fed to the delivery equipment, such as a concrete pump, which propels the mixture through the delivery hose by positive displacement or by compressed air. Additional air is added at the nozzle to increase the nozzle discharge velocity.

c. Comparison of dry-mix and wet-mix processes. Shotcrete suitable for most requirements can be produced by either the dry-mix or wet-mix process. However, differences in the equipment cost, maintenance requirements, operational features, placement characteristics, and product quality may make one or the other more attractive for a particular application. A comparative summary of the advantages and disadvantages of the processes is given in Table 2-1.

(1) Bond strengths of new shotcrete to existing materials are generally higher with dry-mix shotcrete than with wet-mix shotcrete. Both shotcrete mixtures often provide significantly higher bond strengths to existing materials than does conventional concrete.

(2) Typically, dry-mix shotcrete is applied at a much slower rate than wet-mix shotcrete. Dry-mix shotcrete is often applied at a rate of 1 or 2 cubic yards per hour compared to wet-mix shotcrete applied at a rate of up to 7 or 8 cubic yards per hour. Depending on the application, the in-place production rate may be significantly lower because of obstacles, rebound, and other features which may cause delays.

(3) Rebound is the shotcrete material that "bounces" off the shooting surface. Rebound for conventional dry-mix shotcrete, in the best of conditions, can be expected to be at least 20 percent of the total material passed through the nozzle. Wet-mix shotcrete rebounds somewhat less than dry-mix shotcrete.

(4) The use of air-entraining admixtures (AEA) in shotcrete is practical only in wet-mix shotcrete. When batched properly, AEA forms an air-void system suitable for providing frost resistance to wet-mix shotcrete. The formation of an air-void system in dry-mix shotcrete is not possible. However, dry-mix shotcrete, when properly proportioned and applied, will have a compressive strength exceeding approximately 7,000 pounds per

<p>Table 2-1 Comparison of Features of Dry-Mix and Wet-Mix Shotcrete Processes</p>	
<p>Dry-Mix Process</p>	<p>Wet-Mix Process</p>
<p>Mixing water instantaneously controlled at the nozzle by operator to meet variable field conditions.</p> <p>Longer hose lengths possible, if necessary.</p> <p>Limited to accelerators as the only practical admixture.</p> <p>Use of air-entraining admixture not beneficial. Resistance to freezing and thawing is poor.</p> <p>Intermittent use easily accommodated within prescribed time limits.</p> <p>Exceptional strength performance possible.</p> <p>Lower production rates.</p> <p>Higher rebound.</p> <p>Equipment maintenance costs tend to be lower.</p> <p>Higher bond strengths.</p>	<p>Mixing water controlled at plant and measured at time of batching.</p> <p>Normal pumping distances necessary.</p> <p>Compatible with all ordinary admixtures. Special dispensers for addition of accelerators are necessary.</p> <p>Air entrainment possible. Acceptable resistance to freezing and thawing.</p> <p>Best suited for continuous application of shotcrete.</p> <p>Lower strengths, similar to conventional concrete.</p> <p>Higher production rates.</p> <p>Lower rebound.</p> <p>Equipment maintenance costs tend to be higher.</p> <p>Lower bond strengths, yet often higher than conventional concrete.</p>

square inch (psi). It has performed well in moderate exposures to freezing and thawing.

2-4. Fiber-Reinforced Shotcrete

a. Unreinforced shotcrete, like unreinforced conventional concrete, is a brittle material that experiences cracking and displacement when subjected to tensile stresses or strains. The addition of fibers to the shotcrete mixture adds ductility to the material as well as energy absorption capacity and impact resistance. The composite material is capable of sustaining postcrack loadings and often displays increased ultimate strength, particularly tensile strength. Fibers used in shotcrete are available in three general forms: steel fibers, glass fibers, and other synthetic fibers. Natural fiber, a fourth form, is not commonly used in shotcrete and will not be discussed.

b. The use of steel fibers has evolved rapidly since its inception in the late 1950's. The present third-generation steel fibers are greatly superior to the earlier fibers. Early mixing and handling problems which hampered uniform distribution of fibers in a mixture have been minimized by the manufacture of fibers with low-aspect ratios (ratio of length to diameter), surface deformations, and improved shape.

c. The use of glass-fiber-reinforced shotcrete (GFRS) is an adaptation of the technology of using chopped glass fibers and a resin binder. The equipment and process to apply glass-fiber shotcrete is not a conventional shotcrete operation, but requires a special gun and delivery system. This process termed "spray-up" is used extensively in the construction of lightweight panels for building cladding and special architectural features and is usually applied in a plant production situation. A common onsite application is the construction of simulated rock structures for animal exhibits at zoos. The fibers are made from a special zirconium alkali-resistant (AR) glass to resist deterioration in the highly alkaline portland-cement environment. Guidelines for the use of glass-fiber spray-up are provided by the Prestressed Concrete Institute (PCI) (1981).

d. Other synthetic fibers are composed of nylon, polypropylene, polyethylene, polyester, and rayon. The predominant fiber used for shotcrete has been of polypropylene produced in a collated fibrillated form. The primary benefit of synthetic fiber additions to shotcrete is to decrease width of shrinkage cracks in the material.

e. Typical applications for fiber-reinforced shotcrete are for tunnel linings, surface coatings on rock and soil, slopes, structures, embankments, or other structures that may be subject to high deformations or where crack control is needed.

2-5. Silica-Fume Shotcrete

a. Silica fume is a very fine noncrystalline pozzolanic material composed mostly of silica. Silica fume is used in concrete and shotcrete to increase strength, decrease permeability, and enhance cohesion and adhesion. Specific advantages of silica fume in shotcrete are the improved bond strength of shotcrete to substrate surfaces, the improved cohesion of the shotcrete, and the resulting ability to apply thicker layers of shotcrete in a single pass to vertical and overhead surfaces. The material is more resistant to "washout," where fresh shotcrete is subject to the action of flowing water, and rebound is significantly reduced. Shotcrete containing silica fume may have improved resistance to aggressive chemicals.

b. In general, silica-fume shotcrete produces unhardened and hardened material properties which, among other uses, make it suitable as a substitute for polymer-modified shotcrete and accelerated shotcrete applications. Use of silica-fume shotcrete should be considered for many applications that presently use conventional shotcrete because of its bond and strength performance.

c. Silica-fume shotcrete has been widely used in tunnel construction often combined with fibers to control shrinkage cracking. Because of inherent improvements in permeability, silica-fume shotcrete has been used to cap landfills and other waste areas to be sealed from surface water infiltration. Performance in high-strength applications is more easily accomplished with silica-fume shotcrete.

2-6. Polymer-Modified Shotcrete

a. Polymers are incorporated into shotcrete in two ways. In one method, the entire binder is composed of a polymer material. This is no longer a hydraulic-cement product but a polymer shotcrete. The more common use of polymers is the addition of a polymer emulsion to the hydraulic-cement mixture, as with a partial replacement of the mixing water, or as total replacement, which disperses throughout the mixture forming a continuous polymer matrix. This is termed polymer-portland-cement shotcrete.

b. The emulsified polymer for use in shotcrete has usually been styrene butadiene. Acrylic polymer latexes and epoxy resins are less frequently used products for portland-cement systems. The advantage of polymer-modified systems are that the polymers improve flexural and tensile strengths, improve bond, and reduce absorption because of lower permeabilities.

2-7. Accelerated Shotcrete

a. Accelerating admixtures are used extensively in shotcrete. Highly effective accelerators have been developed for rapid setting of shotcrete. Often considered "super-accelerators," these are commonly used with dry-mix shotcrete. With the increasing use of silica fume, the use of accelerators may decline somewhat. In the past, these accelerators were exclusively powdered materials added to dry-mix shotcrete materials. Now

both powdered and liquid admixtures are used in both dry-mix and wet-mix shotcrete. The use of these accelerators with a wet-mix process requires that the accelerator be added at the nozzle rather than batched with the other materials.

b. Applications include tunnel support and linings, seawalls, portions of dams, roof construction, slope protection, and water-retention structures such as canals, thick concrete sections applied vertically or overhead, rapid repairs, and leaks sealed with flashset shotcrete. Accelerated shotcrete is particularly beneficial in tunnel support because it allows rapid section buildup, early strength development, and seals water leakage. For applications in the splash zone of marine structures, an accelerating admixture may be used to prevent freshly placed shotcrete from being washed away by the incoming tide or by wave action.

Chapter 3 Materials, Proportioning, and Properties

The materials, mixture proportions, and properties of shotcrete are similar in many respects to conventional concrete. Much of the guidance of EM 1110-2-2000 for conventional concrete applies to shotcrete as well.

3-1. Cementitious Materials

a. Portland cement.

(1) Cement requirements for shotcrete are similar to those for conventional concrete. Portland cement must meet the requirements of CRD-C 201¹ (American Society for Testing and Materials (ASTM) C 150), Type I or II. Where the shotcrete will be exposed to soil or water high in soluble sulfates, Type II or V should be used as described in EM 1110-2-2000. Blended cement must meet the requirements of CRD-C 203 (ASTM C 595), Type IP or IS, and moderate sulfate resistance may be specified by adding the suffix MS to the type designation. Where structural requirements require high early strength, Type III meeting the requirements of CRD-C 201 (ASTM C 150) cement should be considered.

(2) Low-alkali cement must be specified when the aggregates used are regarded as chemically reactive with the alkalies in the cement (see EM 1110-2-2000).

(3) Air-entraining cement has been used with the wet-mix process and has achieved varied results, with the air content generally much lower than in conventional concrete. Generally, the use of air-entraining cement is not recommended, since in-place air contents are affected by external factors such as air pressure, hose lengths, and equipment type. AEA's allow flexibility to compensate for these factors.

b. Pozzolan. When added to a portland-cement matrix, pozzolan reacts with the calcium hydroxide and water to produce more calcium silicate gel.

¹All CRD-C designations are to *Handbook for Concrete and Cement*, 1949, US Army Engineer Waterways Experiment Station. Parenthetical references are ASTM equivalents.

Consequently, shotcretes with pozzolan may exhibit improved long-term strength performance and lower permeability. Pozzolan is sometimes added to wet-mix shotcrete to enhance workability, improve pumpability, increase resistance to sulfate attack, and reduce expansion caused by the alkali-silica reaction. The use of fly ash facilitates pumping shotcrete long distances. Portland cement replacement with pozzolan should be carefully considered, since early age strength development is delayed. Pozzolans should conform to CRD-C 255 (ASTM C 618). Natural pozzolans and fly ash are not typically used with dry-mix shotcrete. However, silica fume is often used in dry-mix shotcrete and does not delay strength development.

c. Silica fume.

(1) Silica fume is an extremely fine, amorphous pozzolanic material which is a waste product of the silicon, ferrosilicon, or other silicon alloy production in submerged-arc electric furnaces. The silica fume condenses from the exhaust gases forming extremely minute spherical particles. The material is over 85 percent silica dioxide, is approximately 100 times finer than portland cement, and has a specific gravity ranging from 2.1 to 2.6.

(2) Silica-fume additions create several favorable conditions in shotcrete. Because of the pozzolanic nature of silica fume, its addition results in improved strength and durability. Because of its extreme fineness, silica fume particles fill the microscopic voids between cement particles further reducing permeability and increasing the density of the shotcrete. Shotcrete mixtures with silica-fume additions display increased adhesion and cohesion.

(3) Since silica fume is so fine, the material cannot be effectively handled in its dry, natural form. Consequently, silica fume is commercially available in several processed forms. In one form, silica fume is densified to 30 to 40 pounds per cubic foot (pcf) loose bulk density. Further modifications include the addition of powdered water-reducing admixtures (WRA) to produce a formulated product. Silica fume is also available in a pelletized form. Significant mixing action is necessary to completely break down and dissolve the pellets. Slurried silica fume is produced by mixing nearly equal weights of silica fume and water. Slurries are also further modified to include water-reducing admixtures.

(4) Silica-fume additions to wet-mix shotcrete must be made in conjunction with the addition of normal and

high-range WRA's. Silica-fume additions without WRA's would necessitate large water additions to maintain a suitable workability level. The additional water increases the water-cement ratio and negates the benefits of the silica-fume addition. On the other hand, WRA's are not recommended for silica-fume additions to dry-mix shotcrete since the total mixture is in contact with water for only the time when the mixture exits the nozzle and impacts the shooting surface. The use of WRA's into dry-mix shotcrete would cause the compacted shotcrete to slough and sag on the surface as the admixture takes effect.

(5) For wet-mix shotcrete, any of the packaging processes are applicable. If the silica fume is not prepackaged with a WRA, such an admixture must be batched. Dry-mix shotcrete is best proportioned using dry processed products of silica fume.

3-2. Aggregate

a. Aggregate should comply with the quality requirements of CRD-C 133 (ASTM C 33). Table 3-1 shows acceptable grading limits. Grading No. 1 should be used if a mortar mixture is desired. Gradings No. 2 and 3 contain coarse aggregate; the latter is similar to a conventional 19.0-mm (3/4-inch) nominal maximum size aggregate, except for a reduction in the larger sizes to minimize rebound. Aggregate failing to comply with these gradings may be used if preconstruction tests demonstrate that it gives good results. However, a uniform grading is essential. Coarse and fine aggregate should be batched separately to avoid segregation.

b. Fine aggregate for finish or flash coats and certain other special applications may be finer than Grading

No. 1. Finer fine aggregates, however, generally produce shotcretes having greater drying shrinkage, while coarser sands result in more rebound.

c. Lightweight-aggregate shotcrete is most practical for the dry-mix process. Since moisture and aggregate contact is initiated at the nozzle, the severe workability reductions common in conventional lightweight concrete production do not occur.

3-3. Water

a. *Mixing water.* Potable water should be used. If this is not available, the proposed water source should be tested according to CRD-C 400.

b. *Curing water.* No special requirements are necessary for curing water applied to shotcrete (ASTM 1978). Water for curing of architectural shotcrete should be free from elements that will cause staining.

3-4. Chemical Admixtures

a. *Use of admixtures.* Because of shotcrete equipment limitations, the use of admixtures in shotcrete is not the same as in conventional concrete. Admixtures should be tested in the field prior to use on large jobs to ensure that the desired properties are achieved. Chemical admixtures used in shotcrete should comply with the appropriate requirements given in CRD-C 625 (ASTM C 1141). ACI 212.3R (paragraph A-1, ACI (1991a)), "Chemical Admixtures for Concrete," contains detailed information on general use in concrete.

b. *Air-entraining admixture (AEA).* The use of AEA's in shotcrete is practical only in wet-mix shotcrete.

Table 3-1
Grading Limits for Aggregate

Sieve Size	Percent by Mass Passing Individual Sieves		
	Grading No. 1	Grading No. 2	Grading No. 3
3/4-inch			100
1/2-inch		100	80-95
3/8-inch	100	90-100	70-90
0.19 inch (No. 4)	95-100	70-85	50-70
0.093 inch (No. 8)	80-100	50-70	35-55
0.046 inch (No. 16)	50-85	35-55	20-40
0.024 inch (No. 30)	25-60	20-35	10-30
0.012 inch (No. 50)	10-30	8-20	5-17
0.006 inch (No. 100)	2-10	2-10	2-10

Due to the loss of air during the gunning process of the wet-mix shotcrete, the AEA should be batched so that the measured air contents in the plastic mix prior to pumping are twice the desired hardened shotcrete air content. The mixing process required to form the air bubbles does not occur in the dry-mix process, hence a suitable air-void system is not generated using the admixture. Air entrainment has slightly reduced rebound.

c. Water-reducing and retarding admixtures. WRA's meeting the requirements of CRD-C 87 (ASTM C 494) are readily adapted to the wet-mix process but are not used in dry-mix shotcrete due to the ineffectiveness of the admixture when adding the admixture and water at the nozzle. Retarding admixtures are seldom used in shotcrete, except for near horizontal surfaces where subsequent finishing of the shotcrete surface is required.

d. Accelerators.

(1) Accelerators are essential in some shotcrete applications, such as tunnel support, where rapid section buildup and rapid strength development are necessary. Early accelerators were powders consisting of soluble aluminates, carbonates, and silicates. Modern accelerators, both powdered and liquid, fall into a wide assortment of chemical makeups. Accelerators have different effects depending on their chemistry, the chemistry of the cement, and the dosage rate of the admixture. Some of the commercial accelerators contain calcium chloride. Many are caustic, particularly the powdered materials, although not as caustic as in the past.

(2) Tests should be made to establish the compatibility of the particular accelerator with the cement proposed for use on the project and to determine the amount of such accelerator required. Many accelerators reduce 28-day strengths by 25 to 40 percent, depending upon the compatibility of the accelerator and cement. Where the aggregate is reactive, the alkali content of the admixture added to that of the cement should not exceed 0.6 percent by mass of the cement.

(3) Accelerators may reduce the frost resistance of the shotcrete. Some may be very caustic and therefore are a safety hazard. For these reasons and because of their cost, accelerators should only be used where necessary and then only in the minimum quantity necessary to achieve the desired results.

(4) Calcium chloride, an accelerator, should never be used in an amount greater than 2 percent by mass of the

cement, except where "flash set" is needed for stoppage of leaks. It should not be used in sulfate exposures, nor where the shotcrete encases dissimilar metals (such as aluminum and steel) in contact with each other. No admixtures containing calcium chloride should be used where the shotcrete is in contact with prestressing steel.

(5) Liquid accelerators are generally added at the nozzle for dry-mix or wet-mix shotcrete. Powdered accelerators are generally used only for dry-mix shotcrete, added as a powder to the dry ingredients. Accelerators used in wet-mix shotcrete produce quick stiffening, then initial set. However, the final set usually occurs much later than for dry-mix shotcrete. The time of set can be varied widely with these materials, including initial set in less than 1 minute, and final set in less than 4 minutes. Some of these materials can also be used to create a "flash set" for special applications.

e. Polymers. The addition of certain latex emulsions to a conventional portland-cement shotcrete has increased both tensile and flexural strength, improved bonding, and decreased permeability. One common use of these materials has been in the repair of concrete structures in marine environments and those subject to chemical attack. A latex with favorable properties should be selected and the field personnel must be instructed in its behavior.

f. Bonding compounds. Bonding compounds are generally not recommended in shotcrete work, because the bond between shotcrete and properly prepared substrates is normally excellent. When improperly used, bonding compounds can act as bond breakers. Bonding agents should not be used in shotcrete work without an investigation into their effectiveness in each case.

3-5. Reinforcing Steel

a. Reinforcing bars for shotcrete should meet the same specifications as for conventional concrete. Because of the placement method, the use of bars larger than No. 5 or heavy concentrations of steel are not practical. Large bars make it difficult to achieve adequate build-up of good quality shotcrete behind the bar and heavy concentrations of steel interfere with the placement of shotcrete. In general, bar spacings of 6 to 12 inches are recommended for shotcrete reinforcement.

b. It is often advantageous to specify as welded wire fabric, reinforcement either uncoated, galvanized, or epoxy coated. Flat stock should usually be specified in lieu of rolled fabric. Because of the rolled configuration,

rolled welded wire fabric is difficult to place at specified locations. Wire spacing should be as wide as possible to allow shotcrete to be built up behind. Spacing of 6 inches is recommended, however wire spacing as low as 2 inches has been used with 4 inches being more typical.

c. In repair work, a thin shotcrete coating may not require reinforcement. When reinforcement is exposed in the old concrete, but not severely corroded, it may be the only reinforcement necessary. In other cases, additional reinforcement (bars or wire mesh) may be required to replace corroded steel to control temperature cracking, if not to satisfy structural considerations.

3-6. Fiber Reinforcement

a. *Steel fiber reinforcement.* Steel fibers have been used in shotcrete to increase its ductility, toughness, impact resistance, and reduce crack propagation. The fibers are commercially available in lengths ranging from 1/2 to 3 inches. Typical fiber lengths for shotcrete range from 3/4 to 1-1/2 inches and are used in the amount of 1 to 2 percent by volume of the shotcrete. The fibers have little effect on compressive strength and produce only modest increases in flexural strength. However, they provide continued and, at times, improved load carrying capacity after the member has cracked.

b. *Steel fiber source.* Steel fibers are manufactured in several ways. Wire fibers are produced from drawn wire that has been subsequently cut or chopped. Flat steel fibers are cut or slit from sheet of steel or by flattening wire. The melt-extraction process is used to "cast" fibers by extracting fibers from a pool of molten steel. Consequently, fibers are round, flat, or irregular in shape. Additional anchorage is provided by deformations along the fiber length or at the ends. Deformations can be natural irregularities, crimps, corrugations, hooks, bulbs, and others. Collated fibers and fibers with noncircular cross sections reduce the handling and batching problems common with straight, round fibers.

c. *Polypropylene-fiber reinforcement.* Collated fibrillated-polypropylene (CFP) fibers are used in shotcrete. Fiber lengths of 1/2 to 2-1/2 inches have been the most common in use. The common application has been 1 to 2 pounds of polypropylene fibers per cubic yard of shotcrete. The primary benefit is to control thermal and drying shrinkage cracking. More recently, polypropylene doses of up to 10 pounds per cubic yard have been used successfully yielding shotcrete toughness performance approaching that of some steel fiber

shotcrete (Morgan et al. 1989). The hazard from rebound is much less when polypropylene is used. The most common specified length for polypropylene is 1-1/2 inches, although longer lengths are no problem.

d. *Glass fiber source.* Glass fibers are made from high zirconia alkali-resistant glass designated AR glass. Glass fibers, used for fiberglass reinforcement, are designated E glass and should not be used in a portland-cement matrix. While glass fibers may be as small as 0.0002 inch, they are usually bonded together into elements having a diameter of 0.0005 to 0.05 inch. Glass fiber lengths are typically 1 to 2 inches, but a wide range of lengths is possible.

e. *Applicable technology.* ACI 506.1R, "State-of-the-Art Report on Fiber Reinforced Shotcrete" (ACI 1991e), is a comprehensive document covering the full range of fiber shotcrete technology.

3-7. Proportioning of Shotcrete

a. *Considerations.* In general, conventional concrete technology may be applied to shotcrete proportioning. Prior to mixture proportioning, the following should be considered:

- (1) Type of dry-mix or wet-mix shotcrete appropriate for the work.
- (2) The specific job constraints on the shotcrete work.
- (3) The type of specification.
 - (a) Performance versus prescription.
 - (b) Contractor versus Government mixture proportioning.

A mixture proportioning sample submitted is presented in Appendix D.

b. *Mixture proportioning trial batching.*

(1) Since shotcrete performance is highly dependent on application procedures, trial batching and testing is a critical operation in verifying mixture performance. The batching and mixing of wet-mix shotcrete is practically identical to conventional concrete; only the fabrication of specimens is different. However, dry-mix is a distinct process. It is normal procedure to obtain trial mixture proportions for shotcrete from the contractor. Along with

the proportions, test panels and cores of the shotcrete are highly recommended, as discussed in Chapter 5.

(2) Test panels are particularly important for dry-mix shotcrete because laboratory mixtures cannot duplicate as-shot dry-mix shotcrete. Typically, a performance specification of 12-hour, 7-day and/or 28-day compressive strengths will be specified, along with a grading for the aggregate. Both the wet- and dry-mix methods will yield a higher as-shot cement content and lower coarse aggregate content, due to rebound of the aggregate.

c. *Chlorides.* The total chloride ion (Cl⁻) from all sources including mixing water, cement, admixture, and aggregate should not exceed 0.06 percent by mass of cement for prestressed members. For other reinforced shotcrete applications, this limit is increased to 0.10 percent in a moist environment exposed to chloride and 0.15 percent in a moist environment not exposed to chloride.

d. *Nominal maximum size aggregate (NMSA).* The selection of NMSA depends on several factors. The major factors are the allowable shrinkage performance, size of the placement, and the rigidity of the substrate. The amount of rebound, inherent in the shotcrete process, depends on the ability of the substrate and the placed shotcrete to cushion subsequently placed shotcrete. Shotcrete for thin linings on rock or concrete experiences high rebound. Thicker sections and sections on soil structures experience lower rebound. For placements of thin layers on hard surfaces, coarse aggregate should be minimized or eliminated in the mixture to minimize rebound.

e. *Wet-mix proportioning.* Mixture proportioning procedures for the formulation of conventional concrete for pumping applications are applicable for wet-mix shotcrete. The nominal maximum aggregate size is usually 3/4 inch or smaller. The batched cement content will typically range from 500 to 700 pounds per cubic yard. Rich mixtures are common for shotcrete, especially if vertical or overhead shotcrete placement is required. The limiting factor for cement content in a mixture is often governed by the amount of cement necessary for the shotcrete to adhere to a wall or ceiling, not the specified compressive strength. It is not unusual for shotcrete used in vertical and overhead placement to have 28-day strengths in excess of 4,500 psi, due only to the amount of cement necessary to make the shotcrete adhere.

(1) Workability. The slump for wet-mix shotcrete should be near the minimum that the pump will handle. A 3-inch slump should normally be considered the maximum slump to be used. Excess slump will yield lower-strength shotcrete which will tend to slough off of vertical and overhead surfaces.

(2) Entrained air. If air entrainment is to be used, an air content ranging from 8 to 12 percent prior to pumping is typical. The in-place shotcrete will have about one-half of the entrained air that was recorded at the pump.

(3) Admixtures. Additional admixtures generally behave the same in wet-mix shotcrete as they do in conventional concrete. Any admixture should be tested in the mixture proportioning studies and on the test panels prior to usage.

f. *Dry-mix proportioning.* There is no established method of proportioning dry-mix shotcrete. Since it is not practical to perform laboratory trial mixtures for dry-mix shotcrete, field testing of dry-mix proportions is highly advisable, especially if no field data exist for a given dry-mix. The in-place aggregate grading will be finer than the batched grading due to rebound, especially if larger aggregate sizes are used. As with wet-mix shotcrete, the in-place cement factor will be higher also.

(1) Compressive strength. ACI 506 (paragraph A-1, ACI (1991d)), reports typical data on strength versus cement content of dry-mix shotcrete as shown in Table 3-2.

Table 3-2
Strength Versus Cement Content, Dry-Mix Shotcrete,
Typical Data

28-day Compressive Strength psi	Cement Content lb
3,000	500-650
4,000	550-700
5,000	650-850

(2) Workability. The workability of the shotcrete is controlled by the nozzleman at the placement. Water adjustments may be made instantaneously at the placement by adjustment of the water valve.

(3) Entrained air. Air-entraining admixtures have little effect on dry-mix shotcrete since there is no mixing of admixture water and aggregate until impact on the

shooting surface. Some contractors prefer to add an air-entraining admixture to a mix to improve workability.

(4) Admixtures. Accelerators are typically the only admixtures that are used in dry-mix shotcrete. These should be tested to determine that they are compatible with the cement being used and produce the required accelerated times of setting.

(5) Cement content. Cement contents are similar to those used in wet-mix shotcrete. Batch weights for cement of 500 to 700 pounds per cubic yard are typical, with 28-day compressive strengths of more than 4,500 psi common for the mixtures used for vertical and overhead placement.

(6) Water-cement ratio. The batched water-cement ratio for coarse aggregate dry-mix shotcrete typically varies between 0.30 to 0.40.

g. Fiber-shotcrete proportioning.

(1) Steel fiber lengths for shotcrete are typically 1 inch but often range from 3/4 inch to 1-1/2 inches. The fiber should be at least 1/4 inch longer than the diameter of the maximum aggregate size. Shorter fibers are more easily pumped through the system, although more are required for equivalent performance. Fiber batch quantities are dependent on required shotcrete properties. Typical fiber proportions range from 0.5 to 2.0 percent by volume of shotcrete. Deformed fibers and fibers with end anchorage provisions produce shotcrete with properties equivalent to straight fibers at much lower fiber loadings. Since fibers tend to rebound at a greater rate than does aggregate, the fiber batch quantity should be adjusted accordingly.

(2) Proportioning mixtures using glass fibers is discussed by the PCI (1981). Proportioning mixtures using polypropylene fibers is discussed by Morgan et al. (1989).

h. Silica-fume shotcrete proportioning. Silica fume is added to a shotcrete mixture as a cement replacement or in addition to cement. Batch quantities range from 7 to 15 percent by mass of cement. Strength enhancement and decreased permeability is apparent at the lower dosages. Reductions in rebound and increases in cohesiveness for thick applications do not occur until silica-fume dosages exceed approximately 14 percent. Further mixture adjustments to wet-mix shotcrete may be necessary to attain the required workability level.

i. Polymer-modified shotcrete. Polymer emulsions are typically 50 percent solids and 50 percent water. The liquid portion of the emulsion replaces the equivalent volume of water, and the solid portion replaces the same volume of combined solids. Additional adjustments to attain desired workability levels may be required.

3-8. Properties of Shotcrete

As is the case with conventional concrete, shotcrete properties vary dramatically depending on water-cement ratio, aggregate quality, size, and type, admixtures used, type of cement used, and construction practices. The proper use of admixtures, fibers, silica fume, and polymers can improve certain properties. Depending on the needs of the particular application, properties of the shotcrete materials and mixtures should be tested prior to final application.

a. Strength. In terms of compressive and flexural strength, shotcrete can produce strength generally equivalent to conventional concrete. Compressive strengths of up to 12,000 psi have been reported from drilled cores from test panels, and 10,000 psi is often quoted in the literature as a typical high strength. The practicality of strengths over 5,000 psi should be established by laboratory or field testing prior to final use. The ratio between compressive and flexural strength appears to be the same as for conventional concrete. Relationships between water-cement ratio and strength also appear to follow normal patterns, with higher strength associated with lower water-cement ratios. Early strength of shotcrete can be very high, reaching 1,000 psi in 5 hours and 3,000 psi in 24 hours.

b. Bond strength. Although few data on bond strength appear to exist, bond strength with other materials is reported to be generally higher than can be achieved with conventional concrete. ACI 506R (paragraph A-1, ACI (1991d)) and Mahar, Parker, and Wuellner (1975) provide some data on bond strengths of shotcrete to various substrates.

c. Shrinkage. Drying shrinkage is most influenced by the water content of the mixture. Typical values of unrestrained shrinkage range from 600 to 1,000 millionths. Shrinkage is reduced in coarse-aggregate shotcrete and increased in shotcrete without coarse aggregate or shotcrete subject to high rebound. Shotcrete containing silica fume has a tendency to exhibit more shrinkage before setting than shotcrete without silica fume. Procedures similar to those outlined by

Holland (1987) to prevent plastic shrinkage cracking should be implemented.

d. Resistance to freezing and thawing. Wet-mix shotcrete frost resistance is ensured by entraining a proper air-void system. Typically, an air content of 8 to 12 percent in the mixture results in in-place shotcrete having a proper air-void system. Although many dry-mix applications have performed well when subjected to mild freezing and thawing, dry-mix shotcrete is more subject to problems from freezing and thawing than wet-mix shotcrete. This is due to the difficulty in entraining air and creating an adequate air-void system in dry-mix shotcrete.

e. Density and permeability of shotcrete can be excellent, provided good practices are followed in the field.

f. Toughness. The addition of fibers to shotcrete can result in a product displaying significant load carrying capability after the occurrence of the first crack. The relationship of post-crack load capacity to load capacity at first crack is defined as toughness. The type, size, shape, and amount of fiber determines the extent of this performance. The use of the toughness index by load-deflection testing, CRD-C 65 (ASTM C 1018), provides a rational means of specifying and comparing performance. However, recent concerns have developed over the specifics of applying this testing procedure (Gopalaratnam et al. 1991). The reader is advised to consider the cited references and contact CECW-EG for further guidance.

Chapter 4 Equipment and Crew

4-1. General Equipment

There are two basic types of shotcrete delivery equipment known as guns: dry-mix guns and wet-mix guns. Although either type may be used for most shotcrete work, each has its limitations. It is important to select equipment which is capable of placing the job mixture and maintaining an adequate production rate.

4-2. Dry-Mix Process

Cement and damp aggregate are thoroughly mixed, or premixed, and prebagged cement and aggregate are fed through a premoisturizer. The cement-aggregate mixture is then fed into the gun. The mixture is introduced into the delivery hose via a metering device such as a feed wheel. Compressed air is added at the gun and the mixture is carried through the delivery hose to the nozzle. The nozzle is fitted inside with a perforated water ring through which water and admixtures are introduced under pressure and intimately mixed with the other ingredients as they go through the nozzle. The concrete is propelled from the nozzle at high velocity onto the receiving surface.

a. Description of guns. Dry-mix guns are divided into two classifications, the double chamber gun and the continuous feed gun, each of which is capable of delivering mixtures in a wide range of consistencies.

(1) Double chamber. The first gun developed was the double chamber or pot type, introduced in the early 1900's, shown in Figure 4-1. Although the material enters the upper chamber in batches, the valve arrangement is such that the discharge from the lower chamber is continuous. Until recent years, this gun had been used only for mortar mixtures and the production rate was low, but larger, high-production units which will handle coarse aggregate up to about 3/4 inch are now available.

(2) Continuous feed. The continuous-feed gun was introduced about 1960 and is shown in Figure 4-2. Most of these guns will handle mortar or concrete mixtures with aggregate up to about 3/4-inch and will produce shotcrete at production rates up to 2 cubic yards per hour.

b. Plant layout. A typical plant layout for a dry-mix shotcreting operation, including air and water supplies, gun, delivery hose, and nozzle, is shown in Figure 4-3.

4-3. Wet-Mix Process

Cement, aggregates, and admixtures (except accelerators) are thoroughly mixed. The mixture is fed into the gun and propelled through the delivery hose to the nozzle by compressed air or pneumatic or mechanical pumping. Air is injected at the nozzle to disperse the stream of concrete and generate the velocity for shotcrete placement.

a. Description of guns.

(1) Pneumatic-feed. In the pneumatic-feed equipment shown in Figure 4-4, the premixed mortar or concrete is conveyed from the gun through the delivery hose to the nozzle by slugs of compressed air. At the nozzle additional air may be added if needed to increase the velocity and improve the gunning pattern. This equipment can handle mixtures of a consistency suitable for general shotcrete construction, using mixtures containing up to 3/4-inch aggregate. Guns with a dual mixing chamber and a two-way valve allow mixing of materials and a continuous flow operation.

(2) Positive displacement. In the positive displacement equipment shown in Figure 4-5, the concrete is pumped or otherwise forced through the delivery hose without the use of compressed air. Air is injected at the nozzle to disperse the stream of concrete and impart the velocity necessary for shotcrete placement. Positive displacement delivery equipment requires a wetter mixture than pneumatic-feed equipment, and the velocity of the shotcrete being applied is lower. It is difficult to apply shotcrete to vertical and overhead surfaces by this method unless a suitable accelerator is used. This equipment can also satisfactorily shoot material containing 3/4-inch aggregate.

b. Plant layout. A typical plant layout for each of the wet-mix processes is given in Figures 4-6 and 4-7.

4-4. Auxiliary Equipment

a. Batching and mixing equipment. Most shotcrete is batched and mixed in the field using portable mixing equipment or delivered in mixer trucks from a local ready-mixed concrete plant. Mixing equipment for

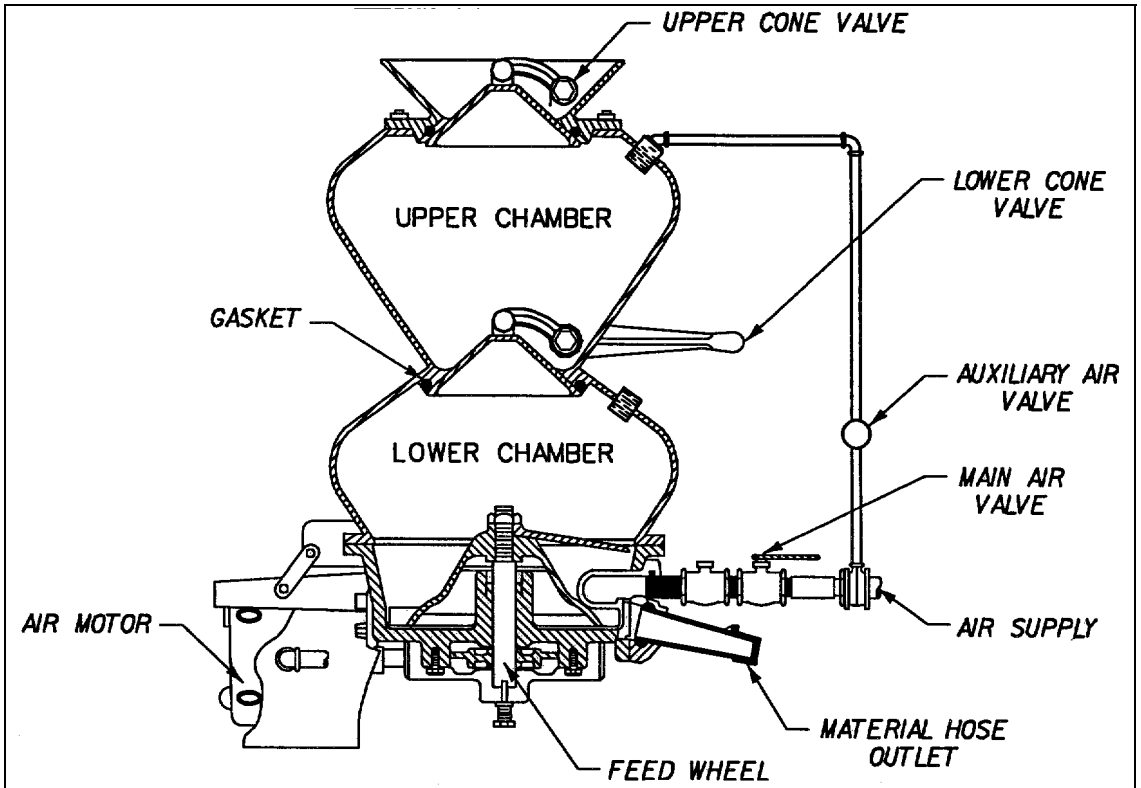

Figure 4-1. Cross section of typical double-chamber dry-mix gun (Crom 1966; copyright permission granted by ACI)

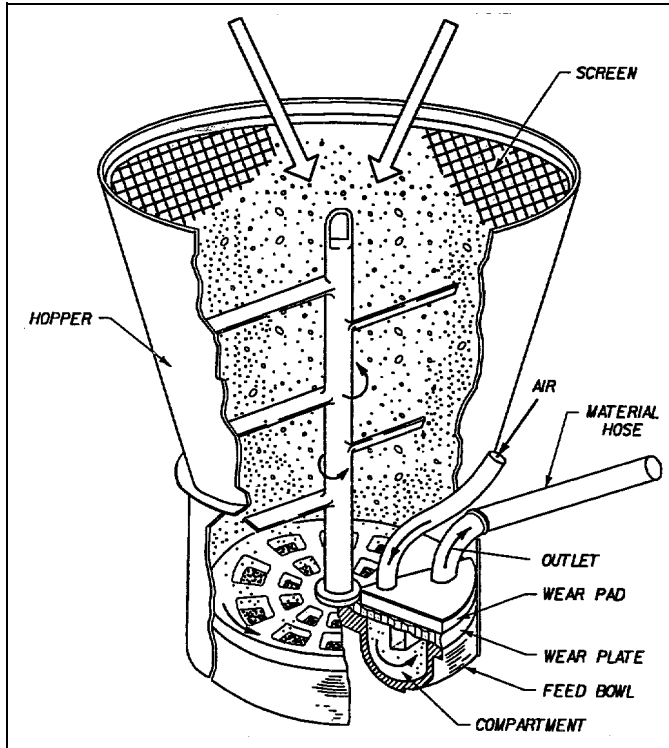

Figure 4-2. Cross section of typical continuous-feed dry-mix gun (Mahar, Parker, and Wuellner 1975)

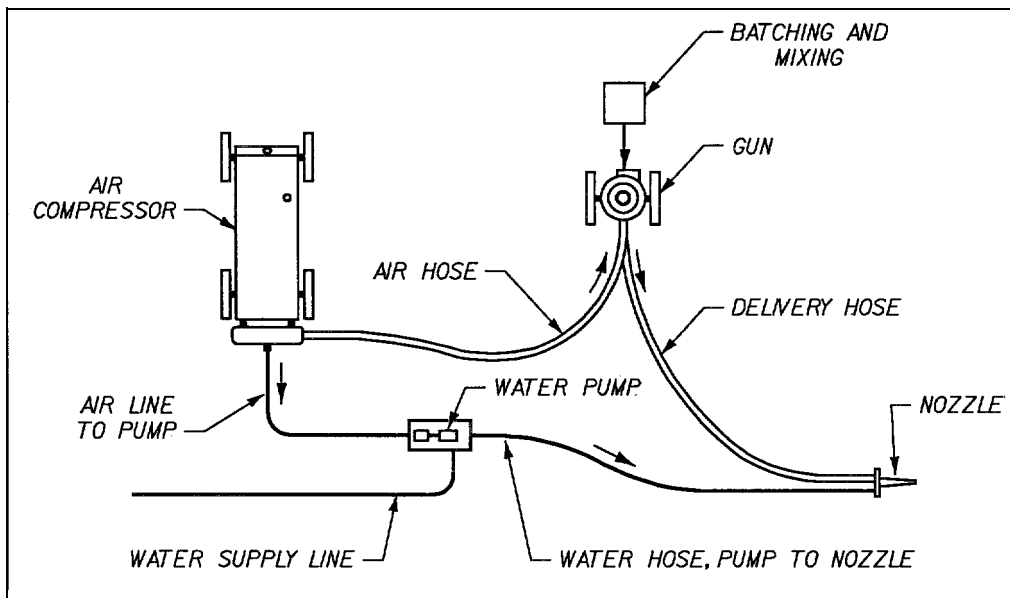

Figure 4-3. Typical plant layout for dry-mix shotcreting (Crom 1966; copyright permission granted by ACI)

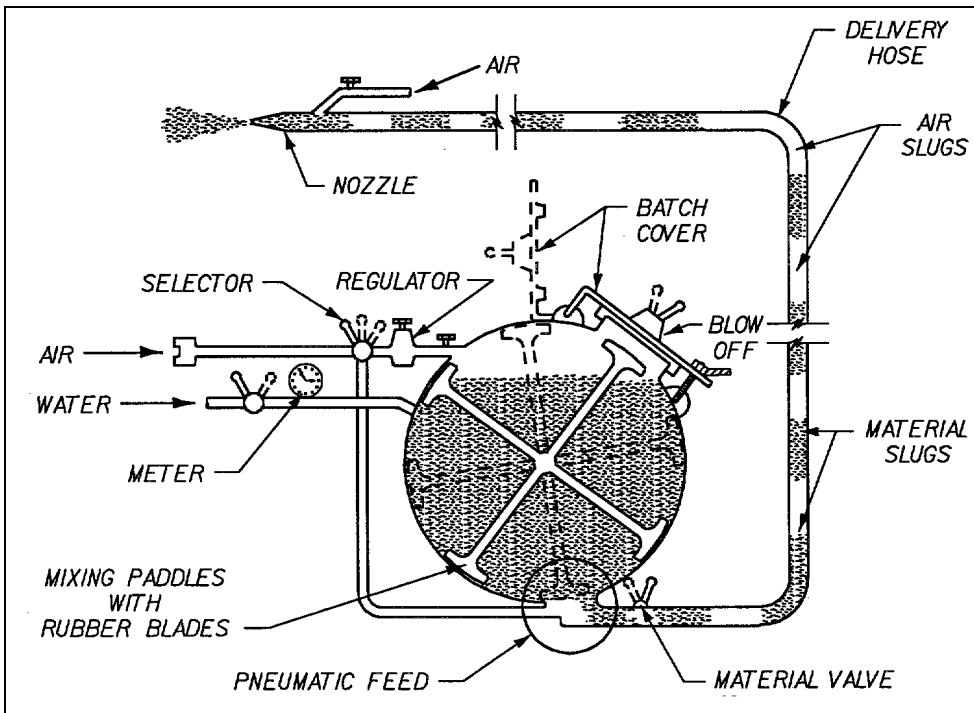

Figure 4-4. Cross section of pneumatic-feed shotcrete gun (Hoffmeyer 1966; copyright permission granted by ACI)

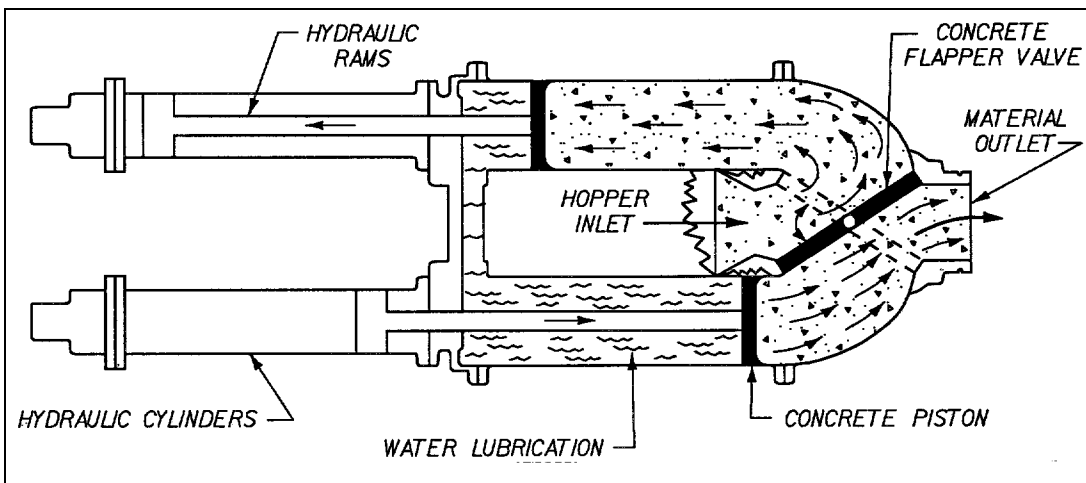

Figure 4-5. Schematic of positive displacement pump (Fredricks, Saunders, and Broadfoot 1966; copyright permission granted by ACI)

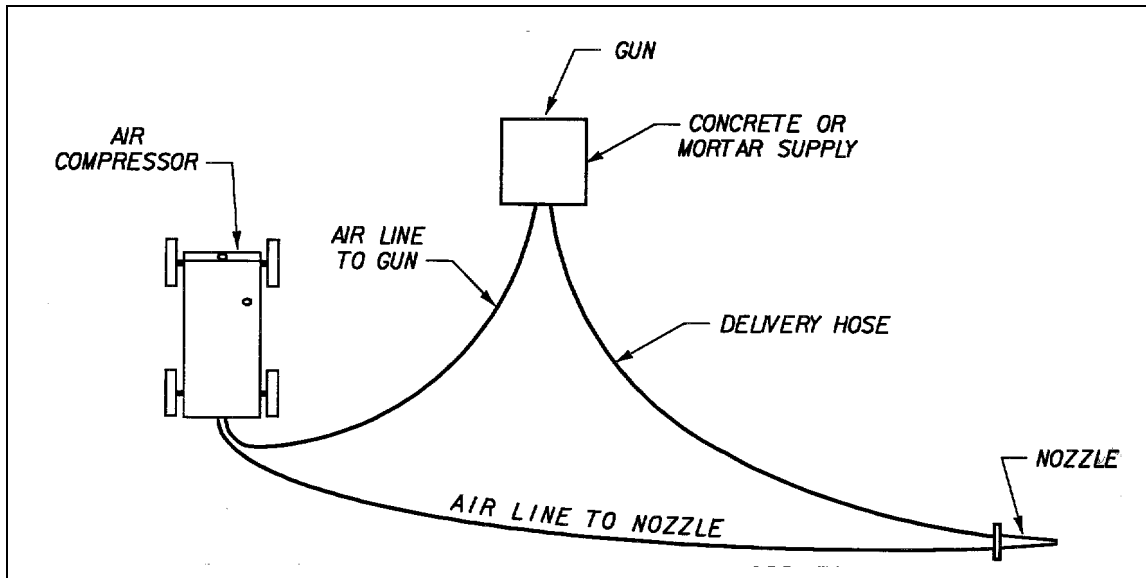

Figure 4-6. Typical plant layout for wet-mix pneumatic-feed equipment

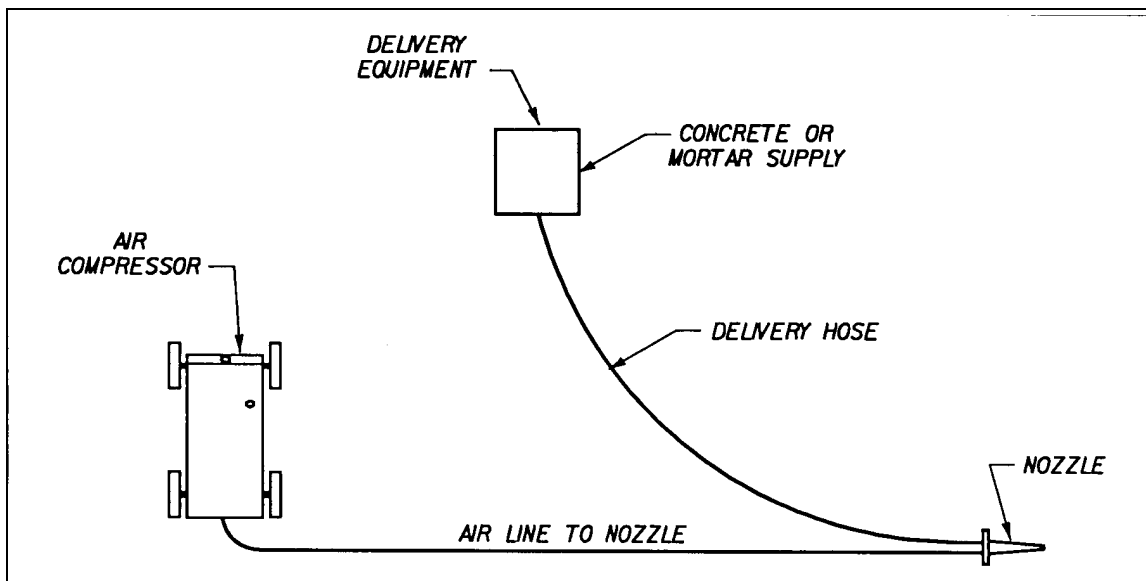

Figure 4-7. Typical plant layout for wet-mix positive displacement equipment

shotcrete is of the batch or the continuous type. Where ready-mixed concrete is used, it should conform to CRD-C 31 (ASTM C 94). Equipment for the batch type should conform to CRD-C 31 (ASTM C 94). In the continuous type, individual ingredients are fed to a mixer screw by means of variable speed augers, belt-feed systems, or a combination of both. This equipment should conform with CRD-C 98 (ASTM C 685). A hopper is sometimes used in high production units of both these types to collect and feed the mixture as required. Water-metering systems are also available to redampen the mixture. Batching and mixing equipment must be capable of maintaining an adequate and continuous flow of homogeneous material. Batching by mass is preferred and will normally be required. Water may be batched by mass or volume. For small jobs, approval may be given to batching by a volumetric container, provided periodic weight checks are made. Since many shotcrete jobs have a low production rate and are in isolated locations, mixing is often done by a small drum mixer at the jobsite.

b. Admixture dispensers. Admixtures may be added when needed during mixing or at the nozzle, depending on their properties and the type of shotcrete process (dry or wet).

(1) In the dry-mix process, dry (powder) admixtures are usually introduced into the mixture during batching. If a continuous feed gun is being used, they may also be added directly into the gun hopper by a special dispenser, usually an auger-type dry dispenser driven by and calibrated to the gear train of the shotcrete machine. The dispenser should be capable of metering a precise quantity of admixture, usually 1 to 4 percent by mass of the cement, into the mixture, and must be capable of accurately varying the ratio of accelerator to cement.

(2) In the dry-mix process, liquid admixtures must be introduced at the nozzle through the mixing water. The admixture may be premixed with water and pumped to the nozzle or added directly to the mixing water at the nozzle.

(3) In the wet-mix process, dry or liquid admixtures may be added to the mixture when batching provided the pumping properties are not adversely altered. As an example, an accelerator would create problems if added during batching, while a high-range water reducing admixture (HRWR) might have beneficial effects. In wet-mix applications, only liquid admixtures may be added to the air supply at the nozzle. They are

proportioned to the delivery rate of the mixture through the material hose.

c. Air compressor. A properly operating air compressor of ample capacity is essential to a satisfactory shotcreting operation. The compressor should maintain a supply of clean, dry, oil-free air adequate for maintaining sufficient nozzle velocity for all parts of the work while simultaneously operating all air-driven equipment and a blowpipe for cleaning away rebound.

(1) Table 4-1 gives recommendations for compressor capacity, diameter of delivery hose, and maximum production rate for the dry-mix process. The operating air pressure is the pressure driving the material from the delivery equipment into the hose and is measured by a gage near the material outlet of the gun. The air pressure should be steady (nonpulsating). A compressor of adequate capacity will ensure that the operating air pressure is sufficient.

(2) The values shown in Table 4-1 are based on a hose length of 150 feet, with the nozzle not more than 25 feet above the delivery equipment. Operating pressures should generally not be less than 40 psi, when 100 feet or less of shotcrete hose is used. Operating pressures are generally increased about 5 psi for each additional 50 feet of hose and about 5 psi for each 25 feet that the nozzle is raised above the gun.

(3) Air requirements for the wet-mix process have not been thoroughly studied. In general, however, the values for the pneumatic-feed type are a little lower than those shown, but back pressures are higher. Positive displacement equipment requires at least 105 ft³/min. at 100 psi at the air ring for proper operation.

(4) Certain moisture conditions will cause an increase of water vapor in the compressed air stream which will adversely affect the shotcrete operation. A moisture trap or filter should always be installed in the supply line from the compressor.

d. Water supply for dry-mix equipment. Water supply booster pumps should be capable of supplying at least a 10-gallon/minute flow at 60 psi at the nozzle for standard nozzles. The water pressure must be constant and must be 15 to 30 psi or more greater than the operating air pressure.

e. Aggregate premoisturizer. It is common practice in large volume dry-mix shotcrete projects to prebag all

the shotcrete materials together in a dry condition at the site. It is advantageous to premoisturize this material to 3-6 percent, by dry mass, prior to entering the shotcrete gun. A premoisturizer is a piece of equipment staged just before the shotcrete gun that uniformly distributes and mixes water to a continuous feed of dry materials.

4-5. Special Equipment

a. Steel fiber-reinforced shotcrete. It is critical that fibers be uniformly distributed throughout the mixture. Proper batching procedures and equipment can prevent the possible problems of fibers tangling together into fiber balls. For small projects, no special equipment is necessary. Fibers can be manually added to the mixture at an appropriate rate to prevent balling of fibers. Larger dry-mix shotcrete projects use prebagged material, including predistributed fibers. Specialized fiber feeder equipment, consisting of a drum and screen mechanism that uniformly screens the individual fibers into the shotcrete mixture, is available for continuous production of shotcrete. As with other continuous-feed systems, calibration of the system is mandatory to achieve proper proportions.

b. Silica-fume shotcrete. No special equipment is necessary for batching and mixing silica-fume shotcrete. Densified or slurried packaging eases manual batching methods common for low production-rate projects. Higher production-rate projects use bin systems similar to flash-feed systems, liquid pumping systems similar to liquid admixture systems, or prebagged materials.

c. Nozzles. A dry-mix nozzle typically consists of a tip, water ring, control valve, and nozzle body arranged in a wide variety of nozzle tips, nozzle sizes, and configurations. Figure 4-8 shows a section of a dry-mix

nozzle. A wet-mix nozzle usually consists of a rubber nozzle tip, an air injection ring, a control valve, and nozzle body. Figure 4-9 shows an example of a wet-mix nozzle section. Some investigations have shown improved mixing action and less rebound for dry-mix shotcrete when a special prewetting nozzle is used and the water ring is placed in the hose 1 to 8 feet before of the nozzle. This has been particularly effective for silica-fume shotcrete.

d. Remote-controlled nozzles. During recent years, the use of remote-controlled nozzles has become increasingly popular, particularly for underground work. These machines are truck-mounted and include a boom-mounted nozzle, a gun, and an air compressor. The remote controls allow the nozzleman to rotate the nozzle in an 18-inch-diameter circle to allow proper application technique. The nozzleman can also swing the nozzle around 360 degrees and maneuver it closer to or farther from the surface being shot. Significant economy is realized because of higher placement rates and reduced crew size. Because of the remote location of the operator, some safety benefits can be realized from avoiding rebound of aggregates and fibers.

4-6. Crew Composition

a. The quality of shotcrete depends largely on the skill of the application crew. The shotcrete crew may consist of four to eight individuals, depending on the size of the operation and the type and setup of equipment. A typical crew may include the foreman, nozzleman, delivery equipment operator, and nozzleman's helpers. Additional personnel such as a delivery equipment operator helper and operator for haulage of materials may also be necessary. By far, the most important member of the crew is the nozzleman.

Table 4-1
Compressed Air Required for Dry-Mix Guns

Compressor Capacity at 100 psi ft ³ /min	Inside Diameter of Delivery Hose inches	Maximum Production Rate yd ³ /hr
365	1	4
425	1-1/4	6
500	1-1/2	9
700	1-3/4	10
900	2	12
1,000	2-1/2	15

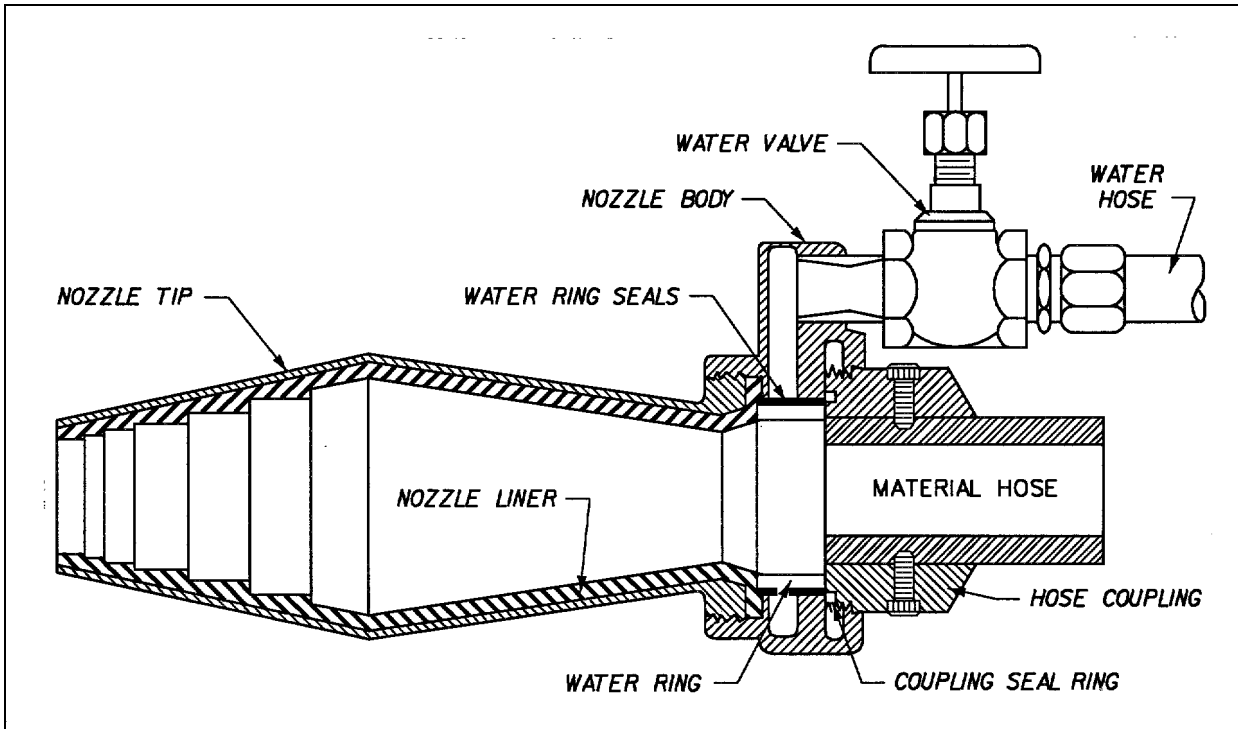

Figure 4-8. Typical dry-mix nozzle (paragraph A-2, ACI 1991c; copyright permission granted by ACI)

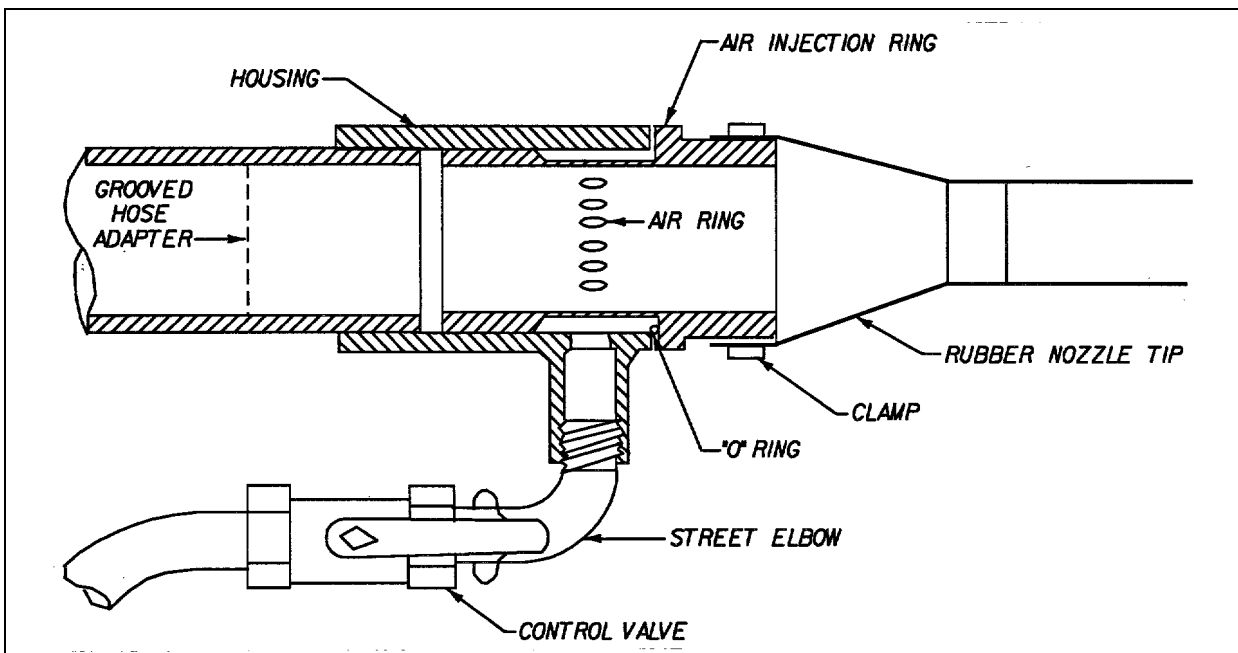

Figure 4-9. Typical wet-mix nozzle (paragraph A-2, ACI 1991c; copyright permission granted by ACI)

b. The success of the shotcrete crew depends largely on the ability of the nozzleman since he controls the surface preparation, the material delivery rate, the impingement of the shotcrete particles on the surface, the thickness, and, in the dry-mix process, the water-cement ratio. The nozzleman should have served an apprenticeship on similar applications and should be certified, as discussed in Chapter 5, for his ability to satisfactorily perform his duties and to gun shotcrete of the required quality. During production he will perform the following duties:

(1) Ensure that all surfaces to be shot are clean and free of laitance or loose material, using air and air-and-water blast from the nozzle as required.

(2) Ensure that the operating air pressure is uniform and provides proper nozzle velocity for good compaction.

(3) Regulate the water content so that the mixture will be plastic enough to give good compaction and a low percentage of rebound, but stiff enough not to sag. (In the dry-mix process the nozzleman actually controls the mixing water, while in the wet-mix process he directs changes in consistency as required.)

(4) Hold the nozzle at the proper distance and as nearly normal to the surface as the type of work will permit to secure maximum compaction with minimum rebound.

(5) Follow a sequence that will fill corners with sound shotcrete and encase reinforcement without voids

behind the steel, using the maximum practicable layer thickness.

(6) Determine necessary operating procedures for placement in close quarters, at extended distances, or around unusual obstructions where placement velocities and mixture consistency must be adjusted.

(7) Direct the crew to start and stop the flow of material and stop the work when material is not arriving uniformly at the nozzle.

(8) Ensure that sand lenses, slough pockets, or laminations are cut out for replacement.

(9) Bring the shotcrete to finished lines in a neat and workmanlike manner.

(10) Assume responsibility for safety in the area where shotcrete is applied. He must be aware of other people in his immediate vicinity and take care not to direct the shotcrete stream irresponsibly. He should always maintain a firm grip on the nozzle and plan his movements so that he does not lose control of the material hose.

c. The nozzleman's apprentice or helper operates an air blowpipe at least 3/4 inch in diameter to assist the nozzleman in keeping all rebound and other loose or porous material out of the new construction (except in classes of work where the trapped rebound can readily be removed by the nozzleman). He also assists the nozzleman in moving hoses and in other assignments as required.

Chapter 5 Preconstruction Testing and Evaluation

5-1. General

Regardless of the size of the project, some form of preconstruction testing and evaluation must be done to assure that competent personnel, equipment, and materials are provided. Prior to application of shotcrete, the quality assurance team must assess the suitability of the shotcrete nozzleman, the materials and mixture proportions, the equipment, crew, and application process. These are confirmed by submittal or performance of:

- a. Nozzleman Certification.
- b. Mixture Proportioning Testing and/or Data.
- c. Preconstruction Demonstration and Testing.

5-2. Nozzleman Certification

a. The success of any shotcrete application is dependent, in large part, on the skills and abilities of the nozzleman. It is imperative that only qualified individuals perform this work. Unlike some other work processes, the application of shotcrete cannot tolerate inexperience or marginal workmanship.

b. The ACI has an ongoing Nozzleman Certification Program. Specifications should require that all nozzlemen hold such certification. Certification requires the successful completion of a two-part written examination on general shotcrete knowledge and specific application knowledge. A shotcrete demonstration, the construction of test panels which are subsequently evaluated for strength, uniformity, and other applicable properties, is also required.

c. Final approval of ACI certified nozzlemen must be contingent on successful demonstration of abilities by applying shotcrete to preconstruction test panels.

5-3. Mixture Proportioning Evaluation

Unlike the evaluation of conventional concrete mixtures, shotcrete testing is difficult to perform in a laboratory environment. The equipment and technique are integral factors in the performance of the mixture. The mixture proportioning study should therefore be conducted under

field conditions insofar as practicable. Mixture proportions are submitted in one of two ways, trial batching or historical data submission.

a. *Trial batching.* Mixture proportions or materials, which have had no previous use, are accompanied by data verifying material properties, mixture proportions, field conditions, test data, and performance. This work is performed specifically for the project on which it will be used. This process requires significant lead time, often in excess of 45 days, to attain the required 28-day strength results. More extensive testing will add more time to this process. This is not a laboratory exercise but a full-scale production of test panels with actual equipment, personnel, and materials. Test panels should be fabricated as described in paragraph 5-4: Preconstruction Demonstration and Testing.

b. *Historical data.* Often, materials and mixture proportions that will meet the requirements for the current project are available from use on previous projects. If past documentation and performance is acceptable, no further testing is necessary. Submission of the historical mixture proportions will suffice. This process greatly reduces the lead time required of the contractor. A historical data submittal includes all material data, mixture proportions, field conditions, and test reports or data summaries.

5-4. Preconstruction Demonstration and Testing

a. *Acceptable equipment and personnel.* Prior to placement of any shotcrete for payment, the contractor should demonstrate the acceptable performance of equipment and personnel. This is done by the fabrication of a series of test panels for each nozzleman. These test panels may also serve for approval of the materials and mixture proportions.

b. *Test panels.* Fabrication of test panels mounted in a framework is the typical way to evaluate the shotcrete process (Figures 5-1 and 5-2). A separate panel should be fabricated for each nozzleman, for each shooting position to be encountered in the structure; e.g., slab, vertical, or overhead. Where the field shotcrete will contain reinforcement, this should be duplicated in at least part of the panels to show whether sound shotcrete is obtained behind reinforcing bars or wire fabric. Each panel should be large enough to obtain all the test specimens needed and also large enough to indicate what quality and uniformity may be expected in the structure: not less than 30 inches square for mortar mixtures and

not less than 36 inches square for concrete mixtures. The thickness should equal that of the structure but should measure no less than 3 inches.

c. *Specimen testing.*

(1) At least five cubes or cores (Figure 5-3) should be extracted from the interior (at least 4 inches from the edge) of each panel for testing. Cores should have a minimum diameter of 3 inches and a length-to-diameter ratio (L/D) of at least one, if possible. Core strengths should be corrected for L/D as described in CRD-C 27 (ASTM C 42). Cube strengths may be reported as determined, or converted to cylinder (L/D = 2) strengths by multiplying by the factor 0.85.

(2) Panels should be cored or sawn no sooner than after 7 days of standard curing. The specimens should be tested in compression at 28 days to evaluate the mixture performance. It is not necessary to test at such a late age to evaluate the process. Depending on the expected strengths, testing at 7 or 14 days is adequate to determine the suitability of the nozzle men and process.

(3) Beams for toughness evaluation and flexural strength testing can be sawn from the test panels. Typical beam dimensions are 4 by 4 by 16 inches.

Beams must be sawn from the interior of the panel and not closer than 4 inches from any edge. Beams must be tested in the same orientation as shotcrete on the structure. For example, shotcrete for thin linings results in a fiber orientation parallel to the finished surface. Beams sawn from test panels should be tested with the shot surface normal to the load application.

d. *Visual examination.* Visual examination of sawn surfaces is the best method of determining the uniformity of the shotcrete. Panels should be sawn into quadrants after 7 days of standard curing. The cut surfaces of the specimens should be carefully examined, and additional surfaces should be exposed by sawing the panel when this is considered necessary to check the soundness and uniformity of the material. Figure 5-4 shows some problem conditions that may be encountered. All cut and broken surfaces should be dense and substantially free from laminations and sand pockets.

e. *Accelerated testing.* Often it is advantageous to correlate accelerated strength development of the shotcrete mixtures with the standard laboratory strength development. This correlation will allow determination of mixture performance at ages of 3 to 5 days. Special equipment and extensive laboratory evaluations are necessary prior to construction for this testing procedure.

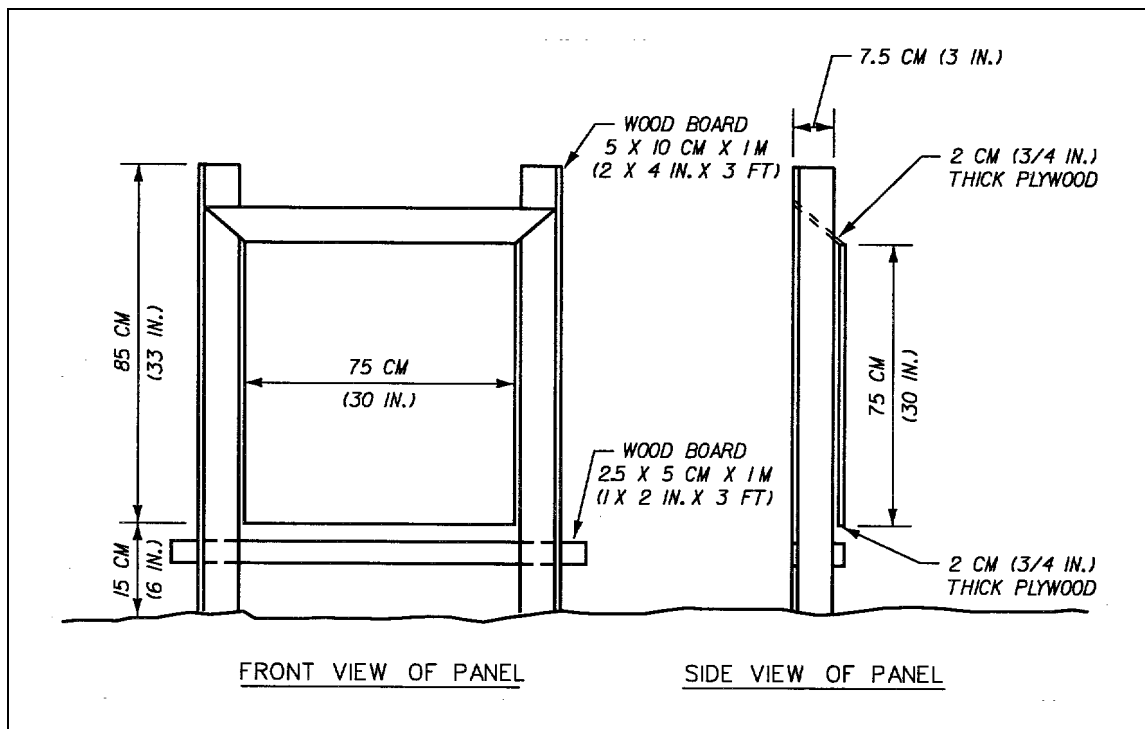

Figure 5-1. Test panel support system (Mahar, Parker, and Wuellner 1975)

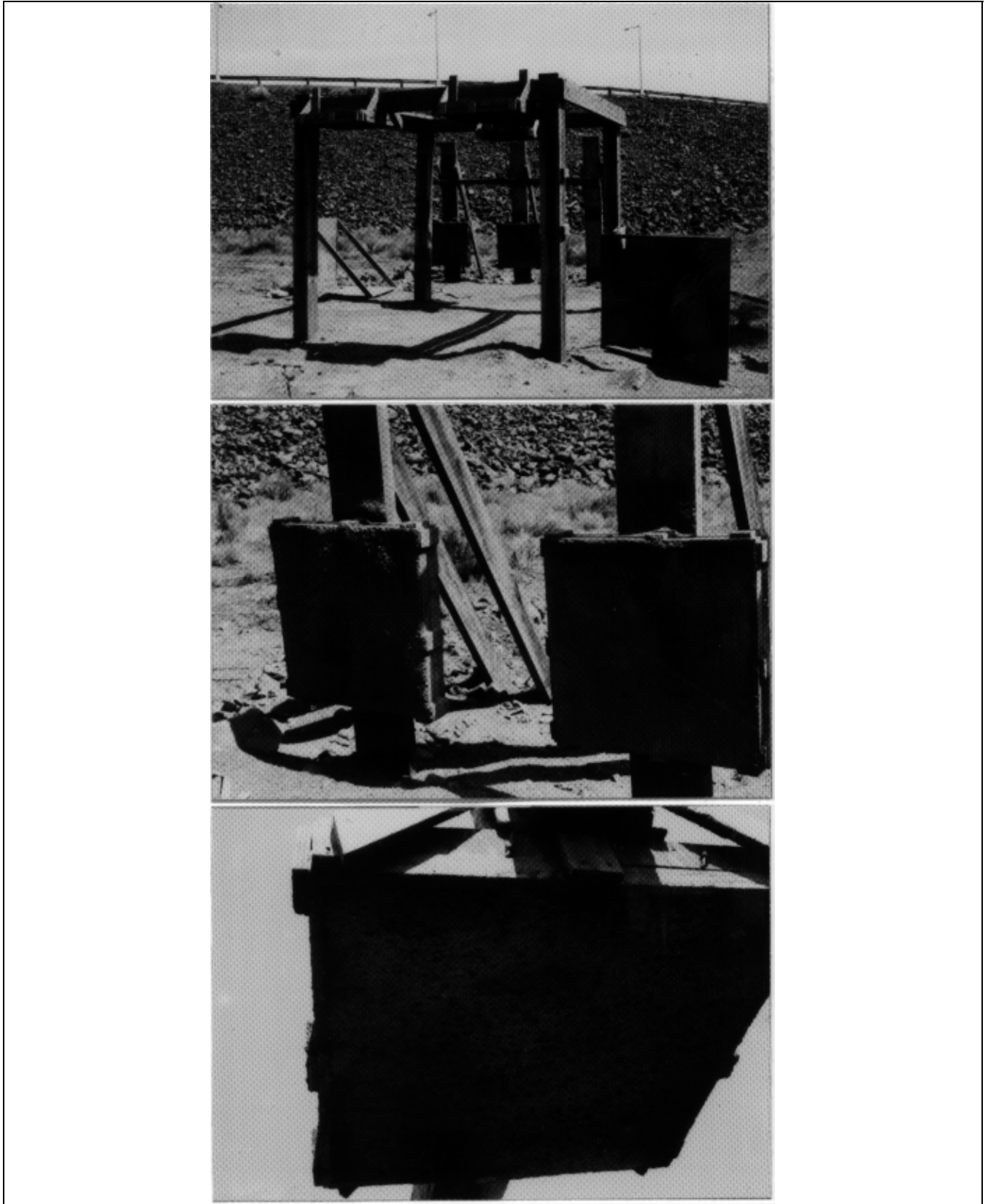

Figure 5-2. Test panel frame system

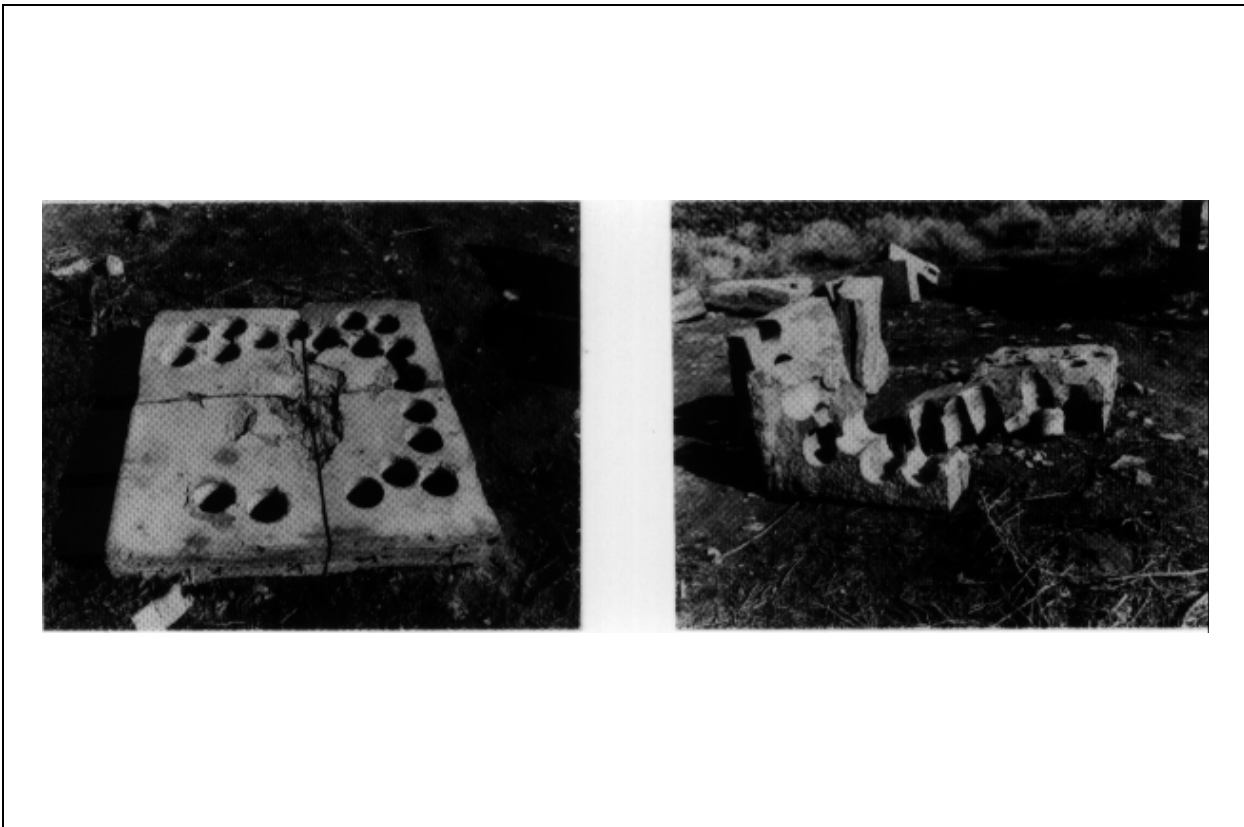
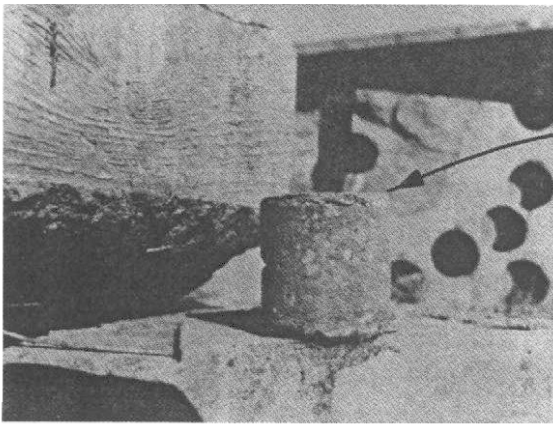

Figure 5-3. Cored and quartered test panels



VOIDS OR "SAND LENSES"
CREATED DURING LAYERING
PROCESS



DELAMINATED FLASH COAT
ON FINISHED SURFACE
OF SHOTCRETE

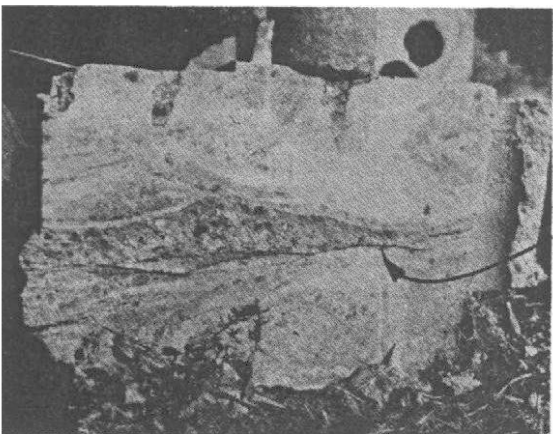

VOIDS BEHIND
REINFORCING STEEL

Figure 5-4. Shotcrete problems obvious from a visual inspection

f. Load deflection testing. Fiber shotcrete performance should be specified by use of toughness index values as determined by CRD-C 65 (ASTM C 1018). The test procedure should be done using the specified equipment, preferably a deflection control testing machine of sufficient stiffness to not bias the results. Toughness index values, termed I5, I10, and I20, should be selected to be compatible with project service conditions. Designers should avoid specifying minimum limits for the I5 index and instead specify limits for the I10 or I20 indexes.

g. Other tests. Tests for absorption, drying shrinkage, resistance to freezing and thawing, and other properties may also be made if desired, using appropriate specimens cored or sawed from the panels.

5-5. Alternate Considerations

a. Typically, preconstruction testing and evaluation must precede the actual work by more than 30 days to

allow time for nozzleman certification at the start and ending with strength testing at 28 days. This protracted start-up period may add significant costs to a small repair contract and may delay the start of actual construction.

b. In the case where previous acceptable mixture proportions information is available for the proposed materials and proportions, it may be advantageous to eliminate the later-age testing of the shotcrete mixture. Some contracting organizations have found it cost effective to evaluate the nozzleman and equipment at a site convenient to the contractor, often in conjunction with the contractor's ongoing work, to eliminate the early mobilization and extended standby time of equipment and personnel.

c. The designer must always consider the criticality of the shotcrete placement and the qualifications of the nozzleman when considering whether or not to waive some of the preconstruction requirements.

Chapter 6 Placement

Shotcreting can be a hazardous operation, especially if the work must be conducted in a relatively confined area.

The critical hazards include control of the material (shooting), rebound, plugged nozzle, hose or coupling breaks, caustic materials, and dusting. All shotcrete operations must be performed in accordance with EM 385-1-1.

6-1. Preparations

a. Unformed sections.

(1) Earth surfaces. Where shotcrete is to be placed against earth surfaces, as in canal linings, the surfaces should first be thoroughly compacted and trimmed to line and grade. Shotcrete should not be placed on any surface which is frozen, spongy, or where there is free water. The surface should be kept damp for several hours before shotcrete is placed.

(2) Rock surfaces. Where shotcrete is to be placed against rock, all loose material, debris, dirt, or other foreign matter must be removed to allow good bond between the rock and the shotcrete. This may not be possible or advisable in hazardous underground applications.

(3) Concrete and masonry surfaces. Where shotcrete is to be used for repairing deteriorated concrete, it is essential that all unsound material first be removed. Chipping should continue until there are no offsets in the cavity which would cause an abrupt change in the thickness of the repair. The perimeter of the repair area may be sawcut or chipped with a slight taper to the center of the area. Feather edging should be avoided. After it has been determined that the surface (whether concrete, masonry, or steel) to which shotcrete is to be bonded is sound, it should be prepared by dry sandblasting, wet sandblasting, grinding, or high-pressure water jetting. Just prior to receiving shotcrete, all such surfaces should be thoroughly cleaned. Porous surfaces should be kept damp, but not wet, before placing shotcrete.

b. Formed surfaces. Forms should be made of plywood sheathing, expanded metal lath, or other suitable material, true to line and dimension. They should be

adequately braced to ensure against excessive vibration and constructed to permit the escape of rebound and air during the gunning operation, particularly in the case of thick structural members. Columns should be formed only on two adjacent sides wherever possible. Satisfactory results may be obtained where three sides are formed, provided the width is at least 1.5 times the depth. Pilasters may be formed on two adjacent or opposite sides. The soffit and one side of beams should be formed, and shores should be set below the soffit in such a manner that no deflection will occur under the load to be imposed. Short, removable bulkheads may be used at intersections. The forms should be oiled or dampened and should be clean just prior to gunning.

c. Work area access. Safe, adequate scaffolding should be provided so that the nozzleman can hold the nozzle at the optimum angle and distance from the surface for all parts of the work. The scaffolding should also provide easy access to the shotcrete surface for screeding and finishing operations.

d. Reinforcing steel repair.

(1) Concrete around the reinforcing should be removed until clean, uncorroded steel is reached. Concrete behind reinforcing steel should be removed to a depth to allow proper placement from a nozzle angles not more than 45 degrees to the surface. This depth is often more than 1.5 times the bar diameter but not less than 1 inch. Reinforcing that is corroded so badly that its usable cross section is reduced must be replaced.

(2) Defective bars are removed by cutting out the defective length and replacing with a new section of reinforcing bar. New bars must be lapped appropriately. Alternate attaching schemes such as butt welding, mechanical splices and other means should be considered carefully.

(3) Anchoring new bars in the existing, sound concrete is done by drilling holes and anchoring the ends with an epoxy grout. The anchorage must be designed to fully develop the load capacity of the bar and accommodate edge conditions near the bar.

(4) Stirrups should be treated the same as bars. The design and placement of the steel should be accomplished to minimize interference with the shotcrete placement. All anchors and bars should be arranged in the repair so that proper cover with shotcrete is provided.

e. New reinforcement.

(1) Reinforcing in shotcrete is designed like conventional concrete. Wire fabric may be used in nonstructural or light structural applications to control the development and depth of shrinkage and temperature cracking.

(2) Wire fabric can control debonding or delamination of the shotcrete if either condition may exist. Small bar reinforcement may be added to fabric to resist movement of the fabric during shotcreting, and to reduce the number of required fabric layers. Bar reinforcement is seldom used in sections thinner than 1-1/2 inches. Wire fabric may be used in sections as thin as 3/4 inch. Steel fibers may be used in lieu of wire fabric. Wire spacing should be a minimum of 2 inches on center. Fabric should be tied similarly to bar reinforcement for shotcrete. Fabric sheets should be lapped one and one-half spaces in all directions. When several layers of wire fabric are required, the first layer is covered with shotcrete prior to placing the next layer, with ties extending from the first layer to the next. At least one layer of fabric is used for each 3 inches of shotcrete.

(3) Bar reinforcement must be sized and positioned to minimize interference with shotcreting. Generally, bar sizes smaller than No. 5 should be used. Larger sizes may be used, but great care must be taken when encasing them with shotcrete. If possible, lapped bars should be separated by at least three bar diameters. One layer of reinforcement is generally sufficient for sections 8 inches or less in thickness. Thicker sections require several layers of bars, with the outer layer spaced to allow easy access to the inner layers. Bars should be rigidly tied with 16-gauge wire to prevent vibration of the bars that could cause sagging of the shotcrete or poor bond. Tie wires should be bent flat in the plane of the mesh. Large knots of wire might become voids in shotcrete. Anchors to support reinforcement are spaced each way at a maximum of 36 inches for floor applications, 24 inches for vertical and inclined applications, and 18 inches for overhead applications. Horizontal reinforcement should not be placed less than 12 inches from the ground or floor slab, especially if loose soil or sand forms the horizontal surface. At this height, it is difficult to shoot from the underside of the reinforcement. There is also a strong tendency for the material stream to pick up sand, soil, or rebound from the ground, thereby creating severe sand pockets.

f. Anchorage. Anchorage of shotcrete follows practice for conventional concrete.

g. Alignment control. A variety of alignment control devices are required to establish the limits of shotcrete placement, including ground wires, guide strips, depth gauges, depth probes, or forms. Ground wires are usually 18 or 20-gauge, high-strength steel wires attached to a turnbuckle or spring to provide tension. Wires may be used to establish corners of the shotcrete work, and may be spaced at 2- to 3-foot intervals for screed guides for flat areas. Guide strips are wood lath attached to crosspieces at 2- to 3-foot intervals, used similarly to wires. Depth gauges, small metal or plastic devices attached to the surface to which shotcrete is being applied, indicate the resulting thickness of the shotcrete. They may be left in place, and slightly covered, if their presence is not damaging. Depth probes are stiff steel wire rods premarked with the thickness of shotcrete, which are inserted into the shotcrete to check thickness.

6-2. Batching and Mixing

a. Equipment. Batching and mixing equipment must be capable of maintaining an adequate and continuous flow of uniform material. Aggregate particles should be well coated with cement paste. Batching by mass is preferred and should normally be required. Water may be batched by mass or volume. For small jobs, approval may be given to batching by a volumetric container, provided periodic checks of mass are made, or batching by volumetric mobile-mixing equipment.

b. Jobsite mixing. Since many shotcrete jobs have a low production rate and are in isolated locations, mixing is often done by a small drum mixer at the jobsite. In such cases, the mixing time should not be less than 1 minute. Where other mixers are proposed, satisfactory evidence should be presented to show they are capable of thorough mixing. The mixer should be capable of discharging all batched material without any carry-over from one batch to the next. It should be inspected and cleaned thoroughly at least twice a day, more often if necessary, to prevent accumulations of batched material and minimize unplanned shutdowns.

c. Dry-mix process.

(1) The moisture content of the fine aggregate should be such that the aggregate-cement mixture will flow through the delivery hose at a uniform rate. It

should not be wet enough to cause slugs in the line, but damp enough for good adhesion between the cement and aggregate and to prevent a buildup of electrostatic charges. The optimum moisture content will depend upon the delivery equipment being used, but it is generally within the range of 3 to 6 percent, by dry mass, for the fine aggregate fraction. The aggregate should be dampened or dried as required to bring the moisture to a satisfactory level. Fluctuations in moisture content should be avoided. The nozzleman must control the mixing water so that the surface of the shotcrete has a slight gloss. Too much water can cause sagging, sloughing, puddling, or drop out, especially in overhead work. Insufficient water is indicated by a dry, dark, sandy surface appearance. This condition increases rebound, creates sand pockets, makes finishing difficult, and can result in weak, laminated shotcrete.

(2) The preferred method of dry-mix batching for large shotcrete projects is to batch materials onsite on a concurrent continuous basis. This is best done using prebagged materials and premoisturizing equipment. However, for smaller projects it is common to batch aggregates, cement, and special materials at a conventional concrete batch plant and to mix in a transit mixer. This damp material is discharged from the transit mixer into the shotcrete gun. It is critical that the total elapsed time from batching to shooting not exceed 45 minutes during hot weather and not more than 90 minutes during cool weather. For low production rate operations these time limits result in batching only small volumes of dry-mix material, often 1 to 3 cubic yards.

(3) Where the cement-aggregate mixture is furnished to the dry-mix shotcrete equipment by truck mixer in the dry state already proportioned, CRD-C 31 (ASTM C 94) applies. Where the ingredients are delivered in dry form and proportioned and mixed at the site, conventional batching plant operations conforming to CRD-C 31 (ASTM C 94) or volumetric batching and mixing plant operations conforming to CRD-C 98 (ASTM C 685) should be used.

(4) For mixtures containing silica fume, prebagging of all materials should be strongly considered. Shotcrete, exceeding the time limits stated in paragraph 6-2, will tend to form balls of cement and silica fume as the mixture continues to roll in the mixer drum. The shotcrete product will exhibit higher rebound, lower strengths, and lower cohesion and adhesion.

d. Wet-mix process.

(1) Batching and mixing operations should generally follow the guidelines given in ACI 304. Where ready-mixed concrete is used, it should conform to CRD-C 31 (ASTM C 94). Some pneumatic-feed guns have two chambers to permit continuous gunning. Concrete is mixed in one chamber while it is being withdrawn from the other. Continuous batching and mixing meeting the requirements of CRD-C 98 (ASTM C 685) may also be used. Delivery of concrete at the desired consistency and uniformity from batch to batch is essential to a good shotcreting operation, especially in vertical and overhead applications.

(2) Batching and mixing operations for wet-mix shotcrete are the same as batching of conventional concrete. Batch plants range from small single-scale manual plants to large automated plants. Mixing is done in transit mixers or in a central mixer at the plant. The addition of special materials such as fibers, silica fume, polymers, and others is done as would be done for conventional concrete.

e. Admixture dispensers. For either the dry-mix or wet-mix process, admixture dispensers should receive special attention to ensure that the material is dispensed within ± 3 percent of the required batch quantity and is uniformly dispersed through the mixture.

6-3. Shotcrete Application Techniques

a. Techniques and procedures. The nozzling techniques and procedures used in applying shotcrete greatly affect the quality of the shotcrete and the amount and composition of rebound. Rebound material may become entrapped in succeeding shotcrete if poor nozzling techniques are followed. The entrapment of rebound results in a decrease in the ultimate strength and durability of the shotcrete.

b. Nozzle angle. Plane surfaces should generally be shotcreted with the nozzle held at 90 degrees to the surface. When this principle is not followed, excessive rebound and decreased compaction usually result. Two exceptions to this practice occur when gunning an interior corner or when encasing reinforcing steel. Interior corners should be gunned by directing the nozzle in the plane bisecting the angle of intersection of the two surfaces (Figure 6-1) which reduces the amount of

rebound entrapped in the corner. Areas with reinforcing steel should be gunned at a slight angle from each side. When gunning horizontal work, the nozzle should be held at a slight angle from vertical so that rebound is blown onto completed work for ease of removal.

c. Nozzle distance. The optimum distance between the shotcrete nozzle and the surface is generally about 3 feet. Rebound increases when the nozzle is held at a distance greater than 3 feet and compaction and strength of the shotcrete are reduced. Rebound can also increase if the nozzle is held closer than 3 feet and no reduction in pressure and delivery rate is made. At reduced distances, the nozzleman is more exposed to rebounding particles.

d. Nozzle motion. A steady circular or elliptical movement of the nozzle across the surface is the proper gunning technique (Figure 6-2). The nozzle should not be directed toward one spot for extended periods since this causes increased rebound and difficulty in controlling the thickness of the layer. When the nozzle is not consistently moved, areas of well-compacted material are formed adjacent to areas that are poorly compacted.

(1) Overspray results when shotcrete material is carried by the airstream but not deposited at the point of application. The material has a reduced cement content and is not consolidated by high-velocity impact resulting in a zone of undesirable low-strength material. A sand pocket results if the overspray is encased by shotcrete. Overspray can be avoided by following proper nozzling techniques.

(2) Horizontal and vertical corners should be filled first to eliminate the common collection areas for overspray. The center of the surface being shotcreted may then be brought to the required thickness.

e. Encasing reinforcement. Encasement of reinforcing steel with shotcrete must be done carefully to prevent pockets of uncemented aggregates from forming behind the bars (Figure 6-3).

(1) To prevent formation of these sand or rock pockets, the nozzle should be held close to the reinforcing bar and at a slight angle from the perpendicular to force material around and behind the bar. The front of the bar should remain clean and free of buildup until the entire bar is encased. A blowpipe should be used during the gunning operation to remove accumulation on the front of the bars and entrapped

rebound from behind the bars (Figure 6-4). The shotcrete mixture should be slightly wetter than normal, although not so wet that there will be sloughing behind the bars. Where bars are closely spaced, more than one bar may be shot from each location.

(2) Proper installation of reinforcing bars and mesh can reduce encasement problems and the potential for major sand pocket voids. All obstacles to the flow of the shotcrete material stream should be kept to a minimum size. For example, a No. 4 bar can be readily encased by a skilled nozzleman, while a No. 8 bar would be very difficult to properly encase.

f. Progression of work.

(1) The bondable material to which shotcrete is to be applied should be clean and free of bond-breaking substances such as dirt, grease, oil, curing agents, paints, or deteriorated material. Once the surface is properly cleaned and prepared for shotcrete, a shooting technique must be used which does not foul or dirty the clean surface.

(2) A thin initial coat of shotcrete should be rapidly applied to the selected work surface before starting the layering of shotcrete. This initial coat protects prepared surfaces from contamination with overspray or rebound. The work area should be of such size that the surface can be maintained "wet" with fresh shotcrete so that initial set does not occur until after shooting of the area is completed. Therefore, the work area size is dependent upon sun exposure, ambient temperature, wind velocity, admixtures in the shotcrete, accessibility of the work surface, equipment being used, and the nozzleman's ability.

(3) Once the initial bonding or wet coat is applied to the entire work area, a second pass over the area may proceed at a slower rate. This pass allows the formation of a thicker buildup of material over the first bonding layer. Corners should be filled first to prevent the accumulation of overspray and rebound, followed by application onto the flat areas.

(4) When the limited work area has been completed, rebound and overspray should be removed from adjoining areas with air before the shotcrete takes initial set. This cleaning effort may be expedited by the finisher and other laborers with trowels, shovels, brooms, and other available equipment.

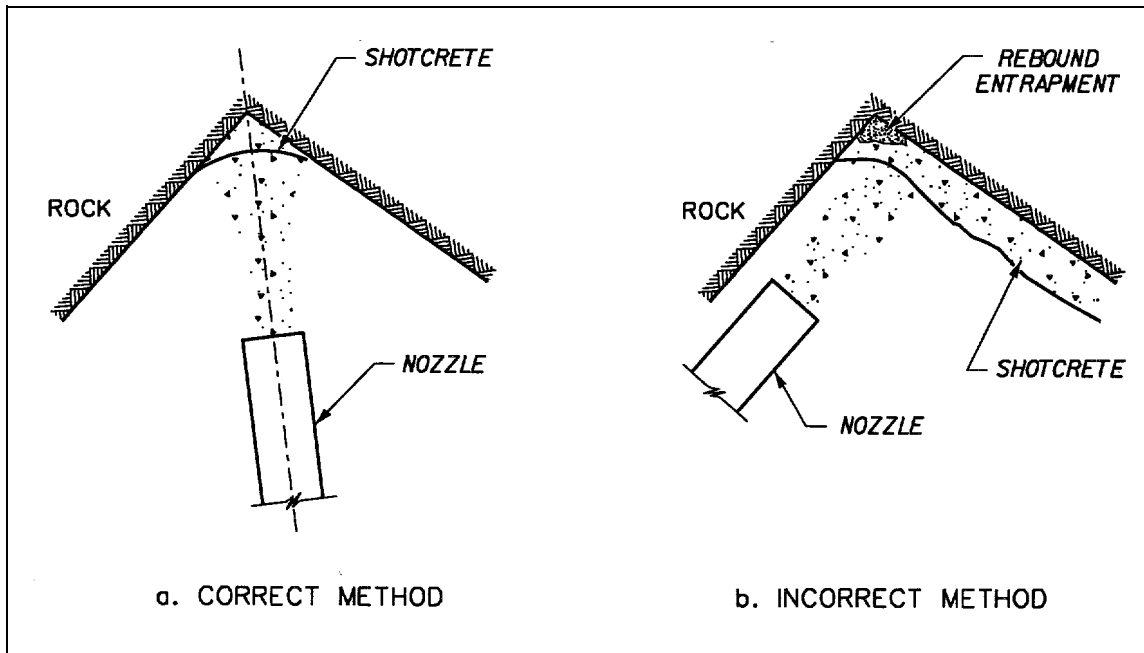

Figure 6-1. Shotcreting interior corners (Mahar, Parker, and Wuellner 1975)

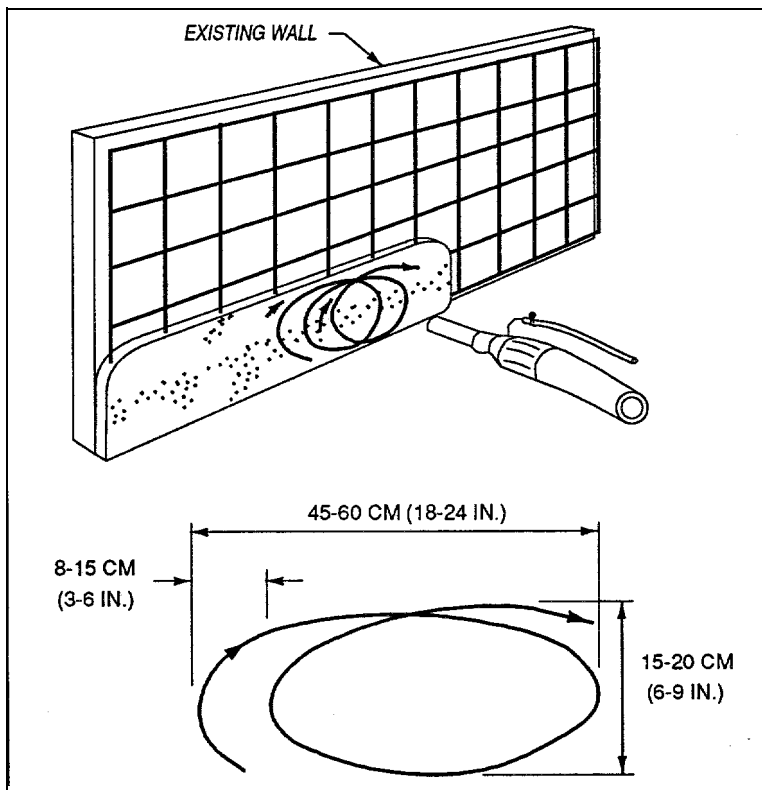

Figure 6-2. Shotcrete nozzle motion (after Ryan 1973)

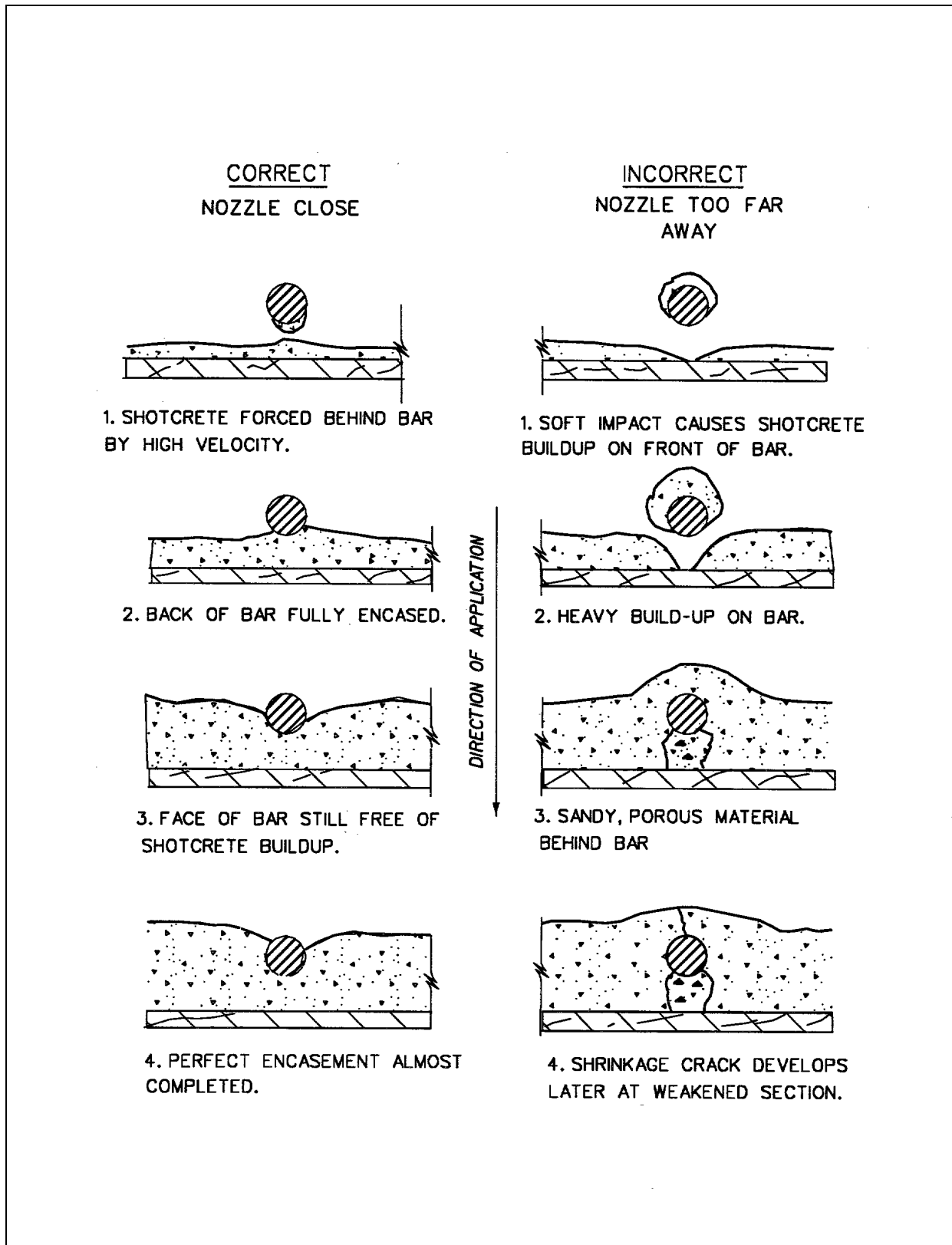

Figure 6-3. Correct and incorrect methods of encasing reinforcing bar with shotcrete (paragraph A-1, ACI 1991d; copyright permission granted by ACI)

(5) When gunning vertical work, shotcrete should be applied from the bottom up. For thick walls, "shelf" or "bench" gunning may be used, where, instead of gunning directly against the vertical surface, a thick layer of shotcrete is built up from the bottom, maintaining a 45-degree slope.

g. Protection. Shotcrete cannot normally be applied during periods of rain, snow, or high wind. Rain may wash out the cement leaving a sandy surface, or it may saturate the shotcrete and cause sloughing or sagging. Strong winds will separate the material between the nozzle and the point of deposit, reducing strength. If proper shields cannot be erected to reduce the effects of the wind, the shotcreting should be discontinued. Because shotcrete rebound, overspray, and dust can damage adjacent surfaces, protection for these surfaces may be needed. Means of protection include plastic or cloth covers, masking materials, temporary coatings, or plywood or other wood. If protection is not feasible, then adjacent surfaces should be cleaned before the contaminant hardens.

h. Construction joints. Construction joints are normally tapered about one-half of the shotcrete thickness or a maximum of 1 inch thick to an edge, over a width of 10 to 20 inches. Square joints can be cut by a trowel at initial set. Ordinarily, square joints should be avoided in shotcrete construction because they form a trap for overspray and rebound. However, if the joint will be subjected to compressive stress, square or butt joints may be required. Steps must be taken to avoid or remove trapped rebound at the joint. The entire joint should be thoroughly cleaned and wetted prior to the application of additional shotcrete.

i. Contraction joints. These joints may be required in some applications, such as canal linings, to control shrinkage cracking of the shotcrete. The joints may be created by prepositioning strips of plastic or metal, and leaving them in place, or by sawcutting the newly hardened shotcrete. Contraction joints are not generally incorporated in such work as tunnel linings or slope protection.

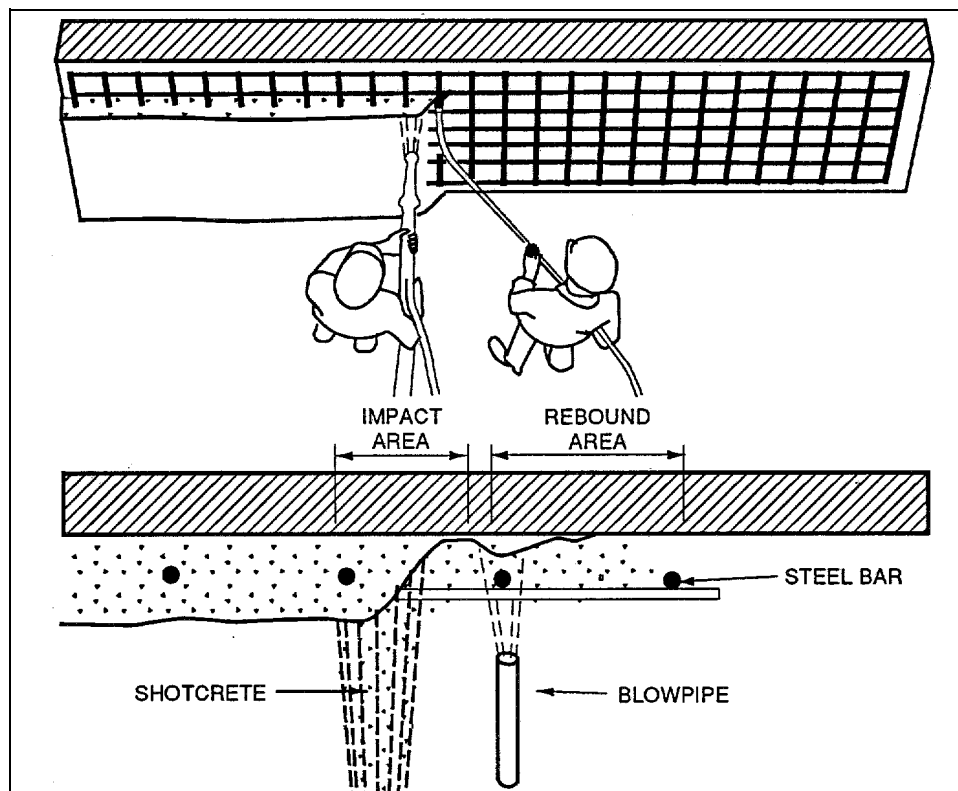

Figure 6-4. Use of a blowpipe in removing rebound for proper encasement of reinforcing bars (after Ryan 1973)

j. Waterstop. Due to the difficulty of placing shotcrete around waterstops, use of waterstops in shotcrete applications should be avoided.

k. Multiple layers. When a layer of shotcrete is to be covered by a succeeding layer, it should first be allowed to develop its initial set. Then all loose material and rebound should be removed by brooming, scraping, or other means. Surface deposits which take a final set should be removed by sandblasting and the surface cleaned with an air-water jet.

l. Time limitations. The time from the batching of shotcrete to final placement should not exceed 45 minutes during warm weather, when ambient temperatures exceed 80 °F. When ambient temperatures are below 80 °F, the time may be extended to a maximum time of 90 minutes. These requirements apply to both wet-mix and dry-mix shotcrete. These time limits may need to be shortened to accommodate additions of polymers, silica fume, or other additives.

6-4. Rebound

a. Rebound is aggregate and cement paste that bounce off the surface during the application of shotcrete because of collision with the hard surface, the reinforcement, or the aggregate particles themselves. The amount of rebound varies with the position of the work, air pressure, cement content, water content, maximum size and grading of aggregate, amount of reinforcement, and thickness of layer. The percent of rebound from conventional cement-aggregate shotcrete by three general types of work surfaces is shown in Table 6-1.

Table 6-1
Rebound from Conventional Cement-Aggregate Shotcrete

Work Surfaces	Percent of Rebound, by Mass	
	Dry-mix	Wet-mix
Floors or slabs	5-15	0-5
Sloping and vertical walls	5-25	5-10
Overhead work	25-50	10-20

b. Rebound will be less for small-aggregate mixtures and more for large-aggregate mixtures. Rebound of silica-fume shotcrete mixes may be as much as 50 percent less than other mixtures because of the highly cohesive nature of silica fume.

c. Initially, the percentage of rebound is large but becomes less after a cushion of fresh shotcrete has been built up. While rebound contains some cement paste, it consists mostly of the coarser aggregate particles. Consequently, the cement content of the in-place shotcrete is higher because of aggregate loss from rebound. This increases the strength of the shotcrete and also increases the tendency toward shrinkage and subsequent shrinkage cracking. Rebound should not be worked back into the construction by the nozzleman. If it does not fall clear of the work, it must be removed. Trapped rebound, if not removed, creates sandy, porous areas and laminations in the cross section which are a great detriment to shotcrete quality. Rebound should not be salvaged and included in later batches because of the danger of contamination. Also, the cement content, state of hydration, and the grading of the aggregate in rebound are all variable and unpredictable.

d. Measurement of rebound from test panels should be considered before beginning the shotcrete operation. Rebound can be collected in traps placed on the ground in front of the panel. The percentage of rebound is determined by dividing the mass of the rebound material by the mass of the shotcrete delivered through the nozzle and multiplied by 100.

e. Shotcrete operations pose the threat of injury from high velocity particles of rock, cement, and dust striking eyes and other exposed areas of the body. Rebounded particles constitute the same type of hazard as the materials in the shotcrete stream, but to a lesser degree since impact on the surface usually reduces their velocities. Suitable headgear must be worn in the vicinity of the nozzling operation. The nozzleman is less likely to be injured than a workman who stands close to the nozzle but at right angles to the material stream. Use of protective clothing and safety equipment will help prevent serious injury from rebound.

6-5. Finishing

a. The natural gun finish is preferred from the standpoints of both structural soundness and durability. Further finishing may disturb the section, harming the bond between the shotcrete and reinforcement or between the shotcrete and the underlying material, and creating cracks in the shotcrete. Additional finishing may also be difficult to accomplish, especially for the drier mixtures. However, the natural gun finish is unacceptable for some structures because of its roughness. Where greater smoothness or better appearance is required, special finishes, as listed, must be applied.

b. After the surface has taken its initial set (crumbling slightly when cut), excess material outside the forms and ground wires may be sliced off using a sharp-edged cutting screed. Upward cutting motions have a tendency to pull the material apart. The ground wires should then be removed, and the irregularities floated. The finish may be left in this condition, or it may be broomed.

c. If a still finer finish or better appearance is desired, a flash coat may be used. This is a thin surface coating containing finer sand than normal and laid on with an application nozzle held well back from the work. It should be applied to the shotcrete surface as soon as possible after the screeding.

d. If desired, the as-gunned finish or flash coat may be followed by surface finishing using one or more of the following tools:

- (1) Wood float, giving a granular texture.
- (2) Rubber float, giving a coarse texture and finish.
- (3) Steel trowel, giving a very smooth finish.

6-6. Curing and Protection

a. Proper curing of shotcrete is extremely important to ensure proper hydration, matrix and bond strength development, and to prevent cracking due to drying shrinkage. Note that the rate of bond strength development is significantly slower than compressive or tensile strength development. The curing procedures of ACI Standard 308 (paragraph A-1, ACI (1991c)) should be followed. The thin sections commonly used in shotcrete construction are particularly susceptible to drying shrinkage. Surfaces should be kept continuously moist for at least 7 days. After this time interval, the

shotcrete has gained sufficient tensile strength to resist shrinkage strains, and the permeability near its exposed surface is low enough to minimize loss of water from the interior of the section. Membrane curing is permissible only when drying conditions are not severe, where no additional shotcrete or paint is to be applied, and where it is esthetically acceptable. Coverage rates of rough shotcrete surfaces should be twice what is used on conventional concrete surfaces.

b. Silica-fume shotcrete must always be continuously moist cured to assure proper strength gain and surface durability. It is common to specify the use of fog nozzles to maintain a moist condition on all new surfaces. While less convenient, sprinklers and soaker hoses can provide adequate curing so long as it can be assured that all the surface area is maintained in a moist condition.

6-7. Repair of Surface Defects in New Shotcrete

a. Surface defects must be repaired as soon as possible after initial placement of the shotcrete. All shotcrete which lacks uniformity, which exhibits segregation, honeycombing, or lamination, or which contains any dry patches, slugs, voids, or sand pockets must be removed and replaced with fresh shotcrete.

b. Core holes are not to be repaired with shotcrete. Instead, they should be filled with a dry-pack mortar.

c. Where surface crazing, shrinkage cracks, or low strengths occur, additional analysis is required to determine the effect upon the structure. In some cases, no remedial action may be required; in others a surface treatment with a polymer may be satisfactory. In cases where the performance of the structure is significantly degraded, the affected shotcrete areas must be removed and replaced with sound shotcrete.

Chapter 7 Quality Control

7-1. General Considerations

Shotcrete is a unique concrete material with many unusual applications that require careful attention to details. It is essential that quality control procedures be established to assure that the final product functions as designed and that it has the desired life expectancy. The contract specifications should clearly call out the Contractor's responsibilities for verifying that the proposed materials, equipment, methods, etc. will meet the requirements of the contract specifications. Required submittals and test reports should be clearly stated in the specifications. ER 1180-1-6 should be followed in regard to the format and details of a contractor quality control (QC) program. The following discussions pertain to technical aspects of shotcrete and should be considered when preparing contractor QC specification requirements and when reviewing the Contractor's QC plan.

7-2. Preproduction Phase

Prior to start of production of shotcrete for any permanent work, the following submittals and test reports should be furnished and the following testing performed by the Contractor to verify that his materials, methods, equipment, and procedures meet the contract requirements.

a. Submittals.

(1) Cementitious materials. Manufacturer's certified test results should be furnished to verify that the cement and pozzolan meet the contract requirements. Appropriate test results should be furnished to verify that silica fume meets the contract requirements.

(2) Aggregates. Test data should be furnished to verify that the fine and coarse aggregates meet the quality and grading requirements of the contract.

(3) Admixtures and curing compound. A manufacturer's certificate of compliance should be furnished to verify that the air-entraining admixture, retarding admixture, water-reducing admixture, accelerating admixture, and curing compound meet the contract requirements.

(4) Fibers and reinforcement. A manufacturer's certificate should be furnished to verify that the proposed fibers and reinforcement meet the requirements of the specifications.

(5) Mixture proportions. Test data should be furnished to verify that the Contractor's proposed mixture proportions will produce shotcrete that meets the quality requirements of the specifications. Test specimens should contain the materials proposed for the project and should be obtained from test panels shot with the equipment and by a nozzleman that will be used for the permanent work.

(6) Accelerator compatibility test. When an accelerator is proposed to be used in the shotcrete, test data per CRD-C 625 (ASTM C 1141) should be furnished to verify that the combination of cement and accelerator meet the contract requirements for initial and final set times.

(7) Nozzleman certification. ACI certifies shotcrete nozzlemen. If required by the specifications, a current certification for each nozzleman who will be placing shotcrete in permanent work should be submitted.

(8) Equipment. If determined to be necessary by the designer and so stated in the contract, the equipment and layout of the proposed plant for producing, conveying, and placing the shotcrete should be furnished to verify conformance with the requirements of the specifications.

(9) Curing and protection. The method of providing the required curing and protection of the in-place shotcrete should be submitted. Hot weather and cold weather protection plans should be submitted.

b. Test panel fabrication, testing, and evaluation. Test panels must be scheduled to be shot early in a project to allow sufficient time for evaluation of the panels prior to start of production of shotcrete for the permanent work. Test panel sizes and configurations are detailed in Chapter 5. Test panels are necessary for evaluation of the proposed shotcrete mixture and to evaluate the qualifications of the proposed nozzleman. Specimens should be sawn or cored from the test panel to verify the contract requirement for strength. The specimens and the test panel should be visually examined for signs of laminations, sand streaks, aggregate pockets, reinforcing steel not completely surrounded by shotcrete,

and any other indications of either mixture proportion problems or nozzleman workmanship.

7-3. Production Phase

An ongoing program of testing should be performed by the Contractor to verify that the materials, methods, and in-place shotcrete meet the requirements of the contract documents. The specifications should clearly state the minimum types of tests that are required, the minimum frequency of performing each test, a procedure for reporting the results of the tests, and a procedure for correcting any deficiencies (Table 7-1).

a. Materials.

(1) Cementitious materials. Manufacturer's certified test results for the cement, pozzolan, and appropriate test data for silica fume should be furnished at the interval specified and whenever a change in the appearance or performance of the material is suspected.

(2) Aggregates.

(a) Quality. Test data should be furnished to verify that the quality of the aggregates meets the requirements of the specifications. Test data should be submitted at established intervals and whenever a change in the appearance or performance of the material is suspected.

(b) Grading. The grading of each aggregate group should be verified by testing according to CRD-C 103 (ASTM C 136) at established intervals and whenever a change in the appearance or performance of the material is suspected. Changes in the grading of an aggregate will cause a change in the water requirements of the mixture with attendant changes in the strength and placing characteristics of the shotcrete.

(c) Moisture content. The moisture content of each aggregate group must be known to calculate the amount of free water to be added to each batch of shotcrete. The moisture contents should be established prior to start of each shift and whenever a change is made in stockpile sources.

(3) Admixtures and curing compound. Manufacturers' certificates of compliance for the air-entraining admixture, retarding admixture, water-reducing admixture, accelerating admixture, and curing compound should be furnished at an established interval and whenever a change in the appearance or performance of the material is suspected.

b. Surface preparation. The Contractor's ability to prepare surfaces according to the requirements of the specifications should be verified during each shift. No shotcrete should be placed until surface preparations are completed. Bonding of the shotcrete layer to the underlying stratum is essential for proper performance and longevity.

c. Shotcrete.

(1) Strength. The strength of the shotcrete should be verified at established intervals. The method of obtaining samples, the method of testing, the frequency of testing, and the required strength should be clearly stated in the contract specifications.

(a) Test panels. A test panel should be shot at least once a shift. The panel should be shot by a nozzleman who is placing shotcrete in permanent work shotcrete. The panel should be at least 18 by 18 by 3 inches. The test panel should be cured at the project site in accordance with the contract requirements until it has attained sufficient strength to allow movement to the testing laboratory. Curing should continue in the test laboratory until specimens are obtained from the panel. Cores or beams should be taken from the panel in accordance with the provisions of CRD-C 27 (ASTM C 42). Cores are used to verify the compressive strength of nonfiber reinforced shotcrete, and beams are used to verify the flexural strength of fiber-reinforced shotcrete.

(b) In-place samples. At established intervals and whenever deemed necessary by the Contracting Officer, cores or beams should be obtained from the in-place shotcrete to verify the strength. The samples should be cured and tested in a manner similar to that of test panel samples.

(2) Mixture proportions. The mixture proportions of the shotcrete should be checked regularly to verify that the original proportions are being maintained. This is generally accomplished by verifying that the batch weights, especially the cementitious materials and water weights, are as required.

(3) Air content. Wet-mix shotcrete is generally required to have a specified air content as determined by CRD-C 41 (ASTM C 231). The air content should be determined at regular intervals and at locations as specified. The air content specified in the contract documents is higher than required for durable conventional concrete and allows for about 50 percent of

Table 7-1 Quality Control Testing Requirements			
Guide to Testing Frequency*			
Property/Activity	Test Procedure	Frequency	Comment
Cementitious Materials	Mill Test	per 400 tons of cement	
Aggregate Quality	CRD-C 133 (ASTM C 33)	Initial	Increase if necessary
Grading	CRD-C 133 (ASTM C 33)	Per shift	
Particle Shape	CRD-C 119 (ASTM D 4791)	Initial	
Moisture Content	CRD-C 113 (ASTM C 566)	Daily	
Unhardened Properties			
Air Content	CRD-C 41 (ASTM C 231)	Per batch	Wet-mix only
Slump	CRD-C 5 (ASTM C 143)	Per batch	Wet-mix only
Mix Proportions		Per shift	
Rebound		Daily	
Thickness		Per 50 ft ²	Probe shotcrete or check gauge wires
Hardened Properties			
Fabricate Test Panels		Per shift	
Drill In-situ Cores	CRD-C 27 (ASTM C 42)	3 per 2,500 ft ²	
Compression Strength	CRD-C 14 (ASTM C 42/C 39)	3 per 2,500 ft ²	
Flexural Strength	CRD-C 16 (ASTM C 42/C 78)	2 per 5,000 ft ²	
Toughness	CRD-C 65 (ASTM C 1018)	3 per 5,000 ft ²	
Surface Roughness		2 per 1,000 ft ²	
Delaminations		1 per 25 ft ²	Fiber-reinforced shotcrete only

* Table values are only a guide. Testing frequency must be based on an evaluation of testing costs, criticality of performance, and the nature of the application.

the air to be lost during the delivery and shooting of the shotcrete. The specification must detail how air content is to be determined. If sampled at the pump, the test is performed as detailed in CRD-C 41 (ASTM C 231).

(4) In-place thickness. Gauge wires or studs should be set prior to placing shotcrete to facilitate placing of the required thickness. It is best to verify thickness by measuring the offset of the gauge wires since later probing of the in-place shotcrete may be very difficult. The in-place thickness of the shotcrete may be verified by probing the fresh shotcrete with a sharp tool. Thin areas should be corrected by immediate application of additional material. Cores of hardened shotcrete may be directed to be taken by the Contracting Officer to verify areas of suspect thickness.

(5) Rebound testing. It is advantageous to periodically determine the amount of shotcrete that is rebounding from the placement surfaces. This can be done by designating a placement area and collecting all the rebound material after the placement is complete. The percent of rebound can be calculated by determining the volume of material shot and the volume of material collected.

(6) Curing and protection. The contractor should verify that the required curing and protection of the shotcrete is being furnished. Proper curing is important due to the generally low water content of shotcrete. Any premature drying could impair the hydration process. Proper protection during hot or cold weather is essential to proper hydration of shotcrete.

(7) Nondestructive testing. The uniformity and quality of in-place shotcrete may be assessed by

nondestructive testing devices such as impact hammers or probes (CRD-C 22 (ASTM C 805) and CRD-C 59 (ASTM C 803)), ultrasonic equipment (CRD-C 51 (ASTM C 597)), and pull out devices (CRD-C 78 (ASTM C 900)). The use of such devices should be at the direction of the Contracting Officer and should be used to identify areas of suspect quality and relative strength, not for actual strength determination.

(8) Delamination testing. Where appropriate, complete shotcrete coatings should be checked for complete bond to the substrate and bond between each shotcrete layer. This can be done using a small hammer on the surface. The contract should require that all delaminated areas be removed and shotcrete reapplied.

(9) Surface tolerances. Some applications may require that exacting surface variation tolerances be met. Verifying that a surface meets a tolerance is best done using the specified length straight-edge and measuring the gap below the edge. The specification should be clear that this method will be the verification method.

(10) Visual inspection. The quality of the shotcrete should be thoroughly evaluated by visual inspection. Surfaces should be inspected for uniformity, voids at the surfaces, varying finish conditions, dry conditions, seepage of water, cracking, and damaged sections.

7-4. Corrective Actions

When a submittal or test report indicates that a material or product fails to meet the contract requirements, the corrective actions specified in the contract documents should be initiated immediately.

Chapter 8 Quality Assurance

8-1. General Considerations

a. Quality Assurance (QA) activities on a shotcrete project should be directed to obtaining compliance with the contract requirements. The quality of the materials used in the production of the shotcrete and of the in-place shotcrete are established during the design stage of the project and should have been clearly stated in the contract documents.

b. A memorandum entitled "Engineering Considerations and Instructions for Field Personnel" should be prepared by the designer in accordance with EM 1110-2-2000. This memorandum outlines the designer's intent and highlights the areas of special concern during construction. If any doubts exist by construction personnel as to the required quality, they should be resolved with the designer as early in the project as possible.

c. Qualified QA personnel with previous experience on shotcrete projects should be assigned to the project. ER 1180-1-6 should be followed in preparing a QA Plan. The following discussions pertain to technical aspects of shotcrete and should be incorporated into the plan.

8-2. Preproduction Phase

a. *Submittals.* Prior to start of production of shotcrete for any permanent work, the required material, equipment, and procedural submittals should be reviewed by the appropriate Corps of Engineers representatives to verify compliance with the contract requirements. On larger projects, government verification of cementitious materials properties should be considered.

b. *Mixture proportioning evaluation.* Test panels shot to verify the proposed mixture performance should be visually examined by QA personnel to confirm uniformity of the shotcrete. Specimens should be taken from the test panels to verify that the specified strength is being attained. The specimens may be taken by either QC or QA personnel, but strength testing should be performed by a Corps of Engineers division laboratory or the project laboratory.

c. *Nozzleman certification.* All nozzlemen shall be ACI certified. Test panels shot to evaluate a

nozzleman's qualifications should be thoroughly examined by a QA representative experienced in shotcrete work. Some panels should contain reinforcing or embedded items that will be included in the permanent work. Panels should be sawn into strips to allow examination of the interior portions of the panels. Panels should be homogeneous without lenses or pockets of aggregate and all reinforcing and embedded items should be completely encased in dense shotcrete. The quality of dry-mix shotcrete is particularly dependent on the skill of the nozzleman, because his ability to control the amount of water being added to the mixture and to shoot test panels to quality is essential.

d. *Shotcrete demonstration.* The same test panel evaluation to certify the nozzleman serves to approve the production and placement process.

8-3. Production Phase

An ongoing program of QA inspections and testing will be required to verify continued conformance with the contract requirements. Consistent materials, mixture proportions, and production methods are necessary for uniform in-place shotcrete.

a. *Submittals.*

(1) Manufacturer's certificate. Manufacturer's certified test results for the cementitious materials, admixtures, curing materials, reinforcement, and fibers should be reviewed to verify continued conformance with the contract requirements. Any changes in the appearance or performance of any of these materials should require additional verification by the supplier or testing by the QC laboratory.

(2) Test reports. Data from test reports must be reviewed to determine contract compliance and, more importantly, product performance. Consistent and vigilant review of data is the best method to spot trends in material quality that may later become a problem.

b. *Testing.* Depending on the size and criticality of the project, QA testing of materials and shotcrete may be required to verify compliance with contract requirements. These tests are in addition to QC tests. They will also serve to verify the ability of the QC laboratory to produce valid test data.

c. *Visual Inspection.* The quality of the shotcrete should be thoroughly evaluated by visual inspection. Surfaces should be inspected for uniformity, voids at the

EM 1110-2-2005
31 Jan 93

surfaces, varying finish conditions, dry conditions, seepage of water, cracking, and damaged sections.

Appendix A References

A-1. Required Publications

¹**ER 1180-1-6**

Construction Quality Management

¹**EM 385-1-1**

Safety and Health Requirements Manual

¹**EM 1110-2-2000**

Standard Practice for Concrete

¹**CW-03361**

Shotcrete

²**US Army Engineer Waterways Experiment Station 1949**

US Army Engineer Waterways Experiment Station. 1949. *Handbook for Concrete and Cement*, with quarterly supplements (all CRD-C designations), US Army Engineer Waterways Experiment Station, Vicksburg, MS.

³**American Concrete Institute 1991a**

American Concrete Institute. 1991a. "Chemical Admixtures for Concrete," ACI Report No. 212.3R-89, *ACI Manual of Concrete Practice*, Part 2, Detroit, MI.

³**American Concrete Institute 1991b**

American Concrete Institute. 1991b. "Guide for Measuring, Mixing, Transporting, and Placing Concrete," ACI Report 304R-89, *ACI Manual of Concrete Practice*, Part 2, Detroit, MI.

¹Reference published by Department of the Army and available through USACE Command Information Management Office sources.

²All Corps of Engineers publications are available on interlibrary loan from the Research Library, US Army Engineer Waterways Experiment Station, ATTN: CEWES-IM-MI-R, 3909 Halls Ferry Road, Vicksburg, MS 39180-6199.

³Reference available through American Concrete Institute, PO Box 19150, Detroit, MI 48219.

⁴Reference available through American Society for Testing and Materials, 1916 Race Street, Philadelphia, PA 19103.

³**American Concrete Institute 1991c**

American Concrete Institute. 1991c. "Standard Practice for Curing Concrete," ACI Report No. 308R-86, *ACI Manual of Concrete Practice*, Part 2, Detroit, MI.

³**American Concrete Institute 1991d**

American Concrete Institute. 1991d. "Guide to Shotcrete," ACI Report No. 506R-90, *ACI Manual of Concrete Practice*, Part 5, Detroit, MI.

³**American Concrete Institute 1991e**

American Concrete Institute. 1991e. "State-of-the-Art Report on Fiber Reinforced Shotcrete," ACI Report No. 506.1R-84, (Reapproved 1989), *ACI Manual of Concrete Practice*, Part 5, Detroit, MI.

American Society for Testing and Materials

⁴**ASTM C 33 (CRD-C 133)**

Standard Specification for Concrete Aggregates

⁴**ASTM C 42 (CRD-C 27)**

Standard Test Method for Obtaining and Testing Drilled Cores and Sawed Beams of Concrete

⁴**ASTM C 94 (CRD-C 31)**

Standard Specification for Ready-Mixed Concrete

⁴**ASTM C 136 (CRD-C 103)**

Standard Method for Sieve Analysis of Fine and Coarse Aggregates

⁴**ASTM C 150 (CRD-C 201)**

Standard Specification for Portland Cement

⁴**ASTM C 231 (CRD-C 41)**

Standard Test Method for Air Content of Freshly Mixed Concrete by the Pressure Method

⁴**ASTM C 494 (CRD-C 87)**

Standard Specification for Chemical Admixtures for Concrete

⁴**ASTM C 597 (CRD-C 51)**

Standard Test Method for Pulse Velocity Through Concrete

⁴**ASTM C 618 (CRD-C 255)**

Standard Specification for Fly Ash and Raw or Calcined Natural Pozzolan for Use as a Mineral Admixture in Portland Cement Concrete

⁴**ASTM C 685 (CRD-C 98)**

Standard Specification for Concrete Made by Volumetric Batching and Continuous Mixing

⁴**ASTM C 803 (CRD-C 59)**

Standard Test Method for Penetration Resistance of Hardened Concrete

⁴**ASTM C 805 (CRD-C 22)**

Standard Test Method for Rebound Number of Hardened Concrete

⁴**ASTM C 900 (CRD-C 78)**

Standard Test Method for Pullout Strength of Hardened Concrete

⁴**ASTM C 1018 (CRD-C 65)**

Standard Test Method for Flexural Toughness and First-Crack Strength of Fiber-Reinforced Concrete (Using Beam With Third-Point Loading)

⁴**ASTM C 1141 (CRD-C 625)**

Standard Specification for Admixture for Shotcrete

A-2. Related Publications

³**American Concrete Institute 1974**

American Concrete Institute. 1974. "Use of Shotcrete for Underground Structural Support," Publication SP-45, Detroit, MI.

³**American Concrete Institute 1980**

American Concrete Institute. 1980. "Performance of Concrete in Marine Environment," Publication SP-65, Detroit, MI.

³**American Concrete Institute 1981a**

American Concrete Institute. 1981a. "Shotcrete Applications," *Concrete International: Design and Construction*, Vol 3, No. 1, pp 23-109, Detroit, MI.

³**American Concrete Institute 1981b**

American Concrete Institute. 1981b. "Application and Use of Shotcrete," Compilation No. 6, Detroit, MI.

³**American Concrete Institute 1991a**

American Concrete Institute. 1991a. "Specifications for Structural Concrete for Buildings," ACI Report No. 301R-89, *ACI Manual of Concrete Practice*, Part 3, Detroit, MI.

³**American Concrete Institute 1991b**

American Concrete Institute. 1991b. "Standard Specification for Bonding Plastic Concrete to Hardened Concrete with a Multi-Component Epoxy Adhesive," ACI Report No. 503.2-79 (Revised 1986), *ACI Manual of Concrete Practice*, Part 5, Detroit, MI.

³**American Concrete Institute 1991c**

American Concrete Institute. 1991c. "Specification for Materials, Proportioning, and Application of Shotcrete," ACI Report No. 506.2-90 (Revisions), Copyright 1972, 1982, *ACI Manual of Concrete Practice*, Part 5, Detroit, MI.

³**American Concrete Institute 1991d**

American Concrete Institute. 1991d. "Guide to Certification of Shotcrete Nozzlemen," ACI Report No. 506.3-82, *ACI Manual of Concrete Practice*, Part 5, Detroit, MI.

⁴**American Society for Testing and Materials 1978**

American Society for Testing and Materials. 1978. "Significance of Tests and Properties of Concrete and Concrete-Making Materials," ASTM STP 169B, Philadelphia, PA.

⁴**American Society for Testing and Materials 1992**

American Society for Testing and Materials. 1992. "Standard Specification for Epoxy-Resin-Basin Bonding Systems for Concrete," "Designation C-881-90, 1992 *Annual Book of ASTM Standards*, Philadelphia, PA; also published as CRD-C 595, *Handbook for Concrete and Cement* (with quarterly supplements), US Army Engineer Waterways Experiment Station, Vicksburg, MS.

²**Brekke, Einstein, and Mason 1976**

Brekke, T. L., Einstein, H. H., and Mason, R. E. 1976 (Jun). "State-of-the-Art Review of Shotcrete," Contract Report S-76-4, US Army Engineer Waterways Experiment Station, Vicksburg, MS.

³**Crom 1966**

Crom, T. R. 1966. "Dry-Mix Shotcrete Practice," *Shotcreting*, SP-14, pp 15-32, American Concrete Institute, Detroit, MI.

³**Crom 1981**

Crom, T. R. 1981 (Jan). "Dry-Mix Shotcrete Nozzling," *Concrete International: Design and Construction*, Vol 3, No. 1, pp 80-93, American Concrete Institute, Detroit, MI.

³**Fredricks, Saunders, and Broadfoot 1966**

Fredricks, J. C., Saunders, N. R., and Broadfoot, J. T. 1966. "Recent Developments in Positive Displacement Shotcrete Equipment," *Shotcreting*, SP-14, pp 75-83, American Concrete Institute, Detroit, MI.

³**Gopalaratnam, Shah, Batson, Criswell, Ramakrishnan, and Wecharatana 1991**

Gopalaratnam, V. S., Shah, S. P., Batson, G. B., Criswell, M. E., Ramakrishnan, V., and Wecharatana, M. 1991 (Jul-Aug). "Fracture Toughness of Fiber Reinforced Concrete," *ACI Materials Journal*, pp 339-353, American Concrete Institute, Detroit, MI.

³**Hoffmeyer 1966**

Hoffmeyer, T. A. 1966. "Wet-Mix Shotcrete Practice," *Shotcreting*, SP-14, pp 59-74, American Concrete Institute, Detroit, MI.

Holland 1987

Holland, T. C. 1987 (Mar). "Working with Silica Fume Concrete," *Concrete Construction*, Vol 32, No. 3, Addison, IL.

⁵**Krantz 1984**

Krantz, Gary W. 1984. "Selected Pneumatic Gunites for Use in Underground Mining: A Comparative Engineering Analysis," Bureau of Mines Information Circular/1984, 64 pp, United States Department of Interior, Washington, DC.

⁴**Luther 1989**

Luther, Mark D. 1989. "Microsilica (Silica Fume) Concrete Durability in Severe Environments," Proceedings of the Structural Congress 1989, American Society of Civil Engineers, New York, NY, pp 95-105.

⁵**Mahar, Parker, and Wuellner 1975**

Mahar, J. W., Parker, H. W., and Wuellner, W. W. 1975 (Aug). "Shotcrete Practice in Underground Construction," Report No. FRA-OR&D 75-90, US Department of Transportation, Washington, DC.

²**McDonald 1991**

McDonald, James E. 1991 (Mar). "Properties of Silica Fume Concrete," Technical Report REMR-CS-32, US Army Engineer Waterways Experiment Station, Vicksburg, MS.

³**Morgan 1988**

Morgan, D. R. 1988 (Jan). "Dry-Mix Silica Fume Shotcrete in Western Canada," *Concrete International: Design and Construction*, Vol 10, No. 1, pp 24-32, American Concrete Institute, Detroit, MI.

⁵**Morgan, McAskill, Richardson, and Zellers 1989**

Morgan, D. R., McAskill, N., Richardson, B. W., and Zellers, R. C. 1989. "A Comparative Evaluation of Plain, Polypropylene Fiber, Steel Fiber and Wire Mesh Reinforced Shotcretes," Transportation Research Record, No. 1226, Concrete and Concrete Construction, Transportation Research Board, National Research Council, Washington DC, pp 78-87.

Prestressed Concrete Institute 1981

Prestressed Concrete Institute. 1981 (Jan-Feb). "Recommended Practice for Glass Fiber Reinforced Concrete Panels," *Journal of Prestressed Concrete Institute*, Vol 26, No. 1, pp 25-93.

³**Reading 1981**

Reading, T. J. 1981 (Jan). "Durability of Shotcrete," *Concrete International: Design and Construction*, Vol 3, No. 1, pp 27-33, American Concrete Institute, Detroit, MI.

³**Rutenbeck 1974**

Rutenbeck, Todd. 1974. "New Developments in In-Place Testing of Shotcrete," *Use of Shotcrete for Underground Structural Support*, SP-45, pp 246-262, American Concrete Institute, Detroit, MI.

⁶**Ryan 1973**

Ryan, T. F. 1973. *Gunite - A Handbook for Engineers*, Cement and Concrete Association, London, England.

²**Tynes and McCleese 1974**

Tynes, W. O., and McCleese, W. F. 1974 (Jul). "Investigation of Shotcrete," Technical Report C-74-5, US Army Engineer Waterways Experiment Station, Vicksburg, MS.

⁵Reference available from National Technical Information Service, Springfield, VA 22151.

⁶Reference available from 11 Grosvenor Crescent, London, SW1X, 7EE, England.

Appendix B Glossary of Terms

Accelerator

A substance which, when added to concrete, mortar, or grout, increases the rate of hydration of a hydraulic cement; shortens the time of setting; or increases the rate of hardening or strength development, or both.

Admixture

A material other than water, aggregate, hydraulic cement, or fiber reinforcement used as an ingredient of concrete or mortar and added to the concrete immediately before or during its mixing.

Air Ring

Perforated manifold in the nozzle of wet-mix shotcrete equipment through which high-pressure air is introduced into the material flow.

Aspect Ratio

A term used to describe the geometry of an individual fiber; it is the ratio of the length of a fiber to the equivalent diameter; the equivalent diameter is that circular area that is equal in area to the cross-sectional area of the fiber.

Bench Gunning

When building up thick sections of vertical work, shotcrete is applied against the advancing top surface of the shotcrete rather than directly against the vertical surface, the top surface of the shotcrete is maintained at a 45-degree slope. (Also known as shelf gunning.)

Blowpipe

Air jet operated by the nozzleman's helper in shotcrete gunning to keep rebound or other loose material out of the work.

Build Up

Gunning of shotcrete in successive layers to form a thicker mass.

Bulking

Increase in the bulk volume of a quantity of sand in a moist condition over the volume of the same quantity dry or completely inundated.

Cutting Screed

Sharp-edged tool used to trim shotcrete to a finished outline.

Delivery Hose

Hose through which shotcrete passes; also known as a material or conveying hose.

Dry-Mix Shotcrete

Pneumatically conveyed shotcrete in which most of the mixing water is added at the nozzle. (See also Pneumatic Feed.)

Feed Wheel

Material distributor or regulator in certain types of shotcrete equipment.

Finish Coat

Final thin coat of shotcrete applied preparatory to hand finishing.

Flash Coat

A light coat of shotcrete used to cover minor blemishes on a concrete surface applied from a distance greater than normal.

Ground Wire

Small-gauge high-strength steel wire used to establish line and grade as in shotcrete work; also called alignment wire or screed wire.

Gun

(1) Shotcrete material delivery equipment used to receive materials and deliver them to the nozzle; the equipment often consists of double chambers under pressure (equipment with a single-pressure chamber is used to some extent). (2) A pressure cylinder used to pneumatically propel freshly mixed concrete.

Gun Finish

Undisturbed final layer of shotcrete as applied from the nozzle, without hand finishing.

Gunite (former trademark)

A method of applying dry-mix shotcrete; term sometimes used for dry-mix shotcrete.

Gunman

Workman on a shotcreting crew who operates the delivery equipment.

Gunning

The act of applying shotcrete; ejection of material from the nozzle and impingement on the surface to be gunned. (Sometimes called shooting.)

Gunning Pattern

Conical outline of the material discharge stream in shotcrete operation.

Hamm Tip

A flared shotcrete nozzle having a larger diameter at midpoint than either inlet or outlet; also called a premixing tip.

Nozzle

A metal or rubber tip attached to the discharge end of a heavy, thick-wall rubber hose from which a continuous stream of shotcrete is ejected onto the placement.

Nozzle Velocity

The rate at which shotcrete is ejected from the nozzle, usually stated in feet per second or meters per second.

Nozzleman

The operator who manipulates the nozzle and controls placement of the shotcrete; in the case of dry-mix shotcrete, the nozzleman also controls the water content of the shotcrete.

Pneumatic Feed

Shotcrete delivery equipment in which material is conveyed by a pressurized air stream.

Positive Displacement Concrete Pump

Wet-mix shotcrete delivery equipment in which the material is pushed through the material hose in a solid mass by a piston, auger, or other displacement type equipment.

Rebound

Aggregate and cement or wet shotcrete which bounces away from a surface against which shotcrete is being projected.

Sand Lenses

A general term for areas in the shotcrete that are either voids or pockets of aggregate that have segregated from the cement, sand lenses are oriented in planes parallel to

the layering of the shotcrete, analogous to rock pockets or honeycomb in conventional concrete.

Sand Pocket

A zone in concrete or mortar containing sand without cement.

Shelf Gunning

When building up thick sections of vertical work, shotcrete is applied against the advancing top surface of the shotcrete rather than directly against the vertical surface; the top surface of the shotcrete is maintained at a 45-degree slope. (Same as bench gunning.)

Shooting

(See gunning.)

Shotcrete

Mortar or concrete pneumatically projected at high velocity onto a surface; also known as air-blown mortar, pneumatically applied mortar or concrete, sprayed mortar, or gunned concrete. (See also Dry-Mix Shotcrete, Pneumatic Feed, Positive Displacement Concrete Pump, and Wet-Mix Shotcrete.)

Sloughing

Subsidence of shotcrete, plaster, or the like, due generally to excessive water in the mixture; also called sagging.

Water Ring

A device in the nozzle body of dry-mix shotcrete equipment through which water is added to the materials.

Wet-Mix Shotcrete

Shotcrete wherein all ingredients, including mixing water, are mixed before introduction into the delivery hose; it may be pneumatically conveyed or moved by displacement. (See also Pneumatic Feed and Positive Displacement Concrete Pump.)

Appendix C
Shotcrete Applications
Corps of Engineers Projects

SHOTCRETE APPLICATIONS Corps of Engineers Projects					
Applications	Type of Shotcrete	Project	Location	District	
Tunnel Lining	Dry-Mix	Little Goose Dam	Snake River, WA	Walla Walla	
Tunnel Lining	Dry-Mix w/Silica Fume	Lower Monumental Dam	Snake River, WA	Walla Walla	
Spillway Ogee	Wet-Mix	Willow Creek Dam	Heppner, OR	Walla Walla	
Canal Lining	Wet-Mix and Wet-Mix with Steel Fibers	Mill Creek Lake	Walla Walla, WA	Walla Walla	
Navigation Lock Coating	Wet-Mix with Glass Fibers and Polymer	Lower Monumental Dam	Snake River, WA	Walla Walla	
Navigation Lock Rehabilitation	Wet-Mix	Emsworth, Dashields Monongahela Lock No. 3	Pittsburgh, PA	Pittsburgh, PA	
Tunnel Lining	Wet-Mix with Steel Fibers	Harlan Diversion Project	Harlan, KY	Nashville	
Rock Slope Prot	Dry-Mix with Accelerator	New Melones Dam	Stanislaus River, CA	Sacramento	
Tunnel Lining	Dry-Mix with Accelerator	New Melones Dam	Stanislaus River, CA	Sacramento	
Rock Slope Prot	Dry-Mix	Little Dell Dam	Del Creek, Utah	Sacramento	
Tunnel Lining	Dry-Mix	Little Dell Dam	Del Creek, Utah	Sacramento	
Sloped Channel Repair/Overlay	Wet-Mix	Los Angeles River Channel	Los Angeles River, CA	Los Angeles	

Appendix D
Mixture Proportioning Sample Submittal

HARCON INCORPORATED
P.O. BOX 2661
POCATELLO, ID. 83206-2661

SHOTCRETE MIX DESIGN (BY VOLUME)

Mix # 1

Project # DACW 68-91-C-0002

LOWER MONUMENTAL PERMANENT JUVENILE FISH BYPASS FACILITIES

Shotcrete Producer: Connell Sand & Gravel, Inc., Connell, Wa.
Shotcrete Uses: Gallery Lining

W/C ratio <= 0.40, Entrained air = NA
Cement from: South Dakota Cement

C.A. = 3/8" x #4 w/ ASTM C 33 combined gradation per 3B-6.3
Bulk S.G.: SSD = 2.81 Absorption = 2.2%
Source = Connell Sand & Gravel

F.A. = Concrete Sand w/ ASTM C 33 combined gradation per 3B-6.3
Source = Connell Sand & Gravel
Bulk S.G.: SSD = 2.706 Absorption = 3.2% F.M. = 3.01

COMPUTATION of 1 CY TRIAL MIX				Revised 5/22/91	
Ingredients		Batch Weights	S.G. SSD		Volume
WATER @ W/C =	0.36	256	1.000		4.095
CEMENT T I-II LA		705	3.150		3.587
C.A. (3/8"x#4)		640	0.21	2.590	3.960
F.A.		2450	0.79	2.625	14.957
SILICA FUME		56	0.08	2.200	0.408
VOLUME					27.006

Additives: None

Water Source: Same as for structural concrete

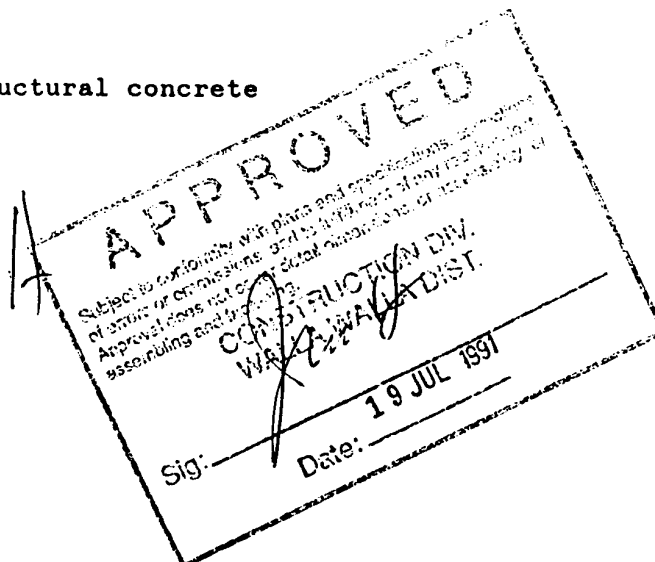

91-02---3B-2.1----1

TILBURY CEMENT COMPANY		
DATE-06-04-91 Connell Sand & Gravel		
Sieve Size	Percent Passing	Specification
3/8"	100	100
#4	98	95-100
8	77	80-100
16	70	50-85
30	42	25-60
50	15	10-30
100	5	2-10
200	2	
F M	2.83	
Screen Size	Percent Passing	ASTM Specification
3/8"	100	85-100
#4	13	10-30
#8	4	0-10
#16	0	0-5
Screen Size	80% Sand 20% 3/8" Percent Passing	Specification
1/2"	100	100
3/8"	100	90-100
#4	81	75-85
8	62	50-75
16	55	35-55
30	34	20-35
50	12	8-20
100	4	2-10

TESTED BY



INTERMOUNTAIN MATERIALS TESTING, INC.
7446 Lemhi St., Boise, Idaho 83709 (208) 378-8203
1718 West A St., Pasco, Washington 99301 (509) 547-1121

Materials Engineering and Testing • Construction Inspection • Project Consultation

REPORT TO: Fausett Mine Services
P.O. Box 968
Osborn, ID 83849

DATE: 6-26-91
FILE NUMBER: 91-53
SHEET: 2 of 6
INVOICE: T910279

PROJECT: Lower Monumental Dam

Sample Identification

On May 29, 1991, your personnel delivered to our laboratory shot crete cores. It was reported that the test panels were shot on May 22, 1991, by your operator, Rainville. The panels were reportedly shot at horizontal position, using mix #1 (7.5 bag mix with 8X silica flume).

At your request, we performed compressive strength tests in accordance with ASTM C42. The test results are as follows.

Test Results

Lab Number	Date Tested	Age	<u>Length</u> Diameter	Compressive Strength PSI
911833	6-05-91	14	<u>4.88</u> 2.75	4100
911834	6-05-91	14	<u>4.88</u> 2.75	4130
911838	6-19-91	28	<u>5.50</u> 2.75	6770
911839	6-19-91	28	<u>4.875</u> 2.75	6180

Reviewed by Lew A. Beck



INTERMOUNTAIN MATERIALS TESTING, INC.
7446 Lemhi St., Boise, Idaho 83709
1718 West A St., Pasco, Washington 99301
(208) 376-8203
(509) 547-1121

Materials Engineering and Testing • Construction Inspection • Project Consultation

REPORT TO: Fausett Mine Services
P.O. Box 968
Osborn, ID 83849

DATE: 6-26-91
FILE NUMBER: 91-53
SHEET: 4 of 6
INVOICE: T910E79

PROJECT: Lower Monumental Dam

Sample Identification

On May 29, 1991, your personnel delivered to our laboratory shotcrete cores. It was reported that the test panels were shot on May 22, 1991, by your operator, Easley. The panels were reportedly shot at horizontal position, using mix #1 (7.5 bag mix with 8% silica fume).

At your request, we performed compressive strength tests in accordance with ASTM C42. The test results are as follows.

Test Results

Lab Number	Date Tested	Age	Length Diameter	Compressive Strength PSI
911854	6-17-91	26	<u>4.375</u> 2.75	5910
911855	6-17-91	26	<u>4.625</u> 2.75	5860
911856	6-19-91	28	<u>4.00</u> 2.75	6480
911857	6-19-91	28	<u>4.50</u> 2.75	6700

Reviewed by Lew A. Beck



INTERMOUNTAIN MATERIALS TESTING, INC.
7446 Lemhi St., Boise, Idaho 83709 (208) 376-8203
1718 West A St., Pasco, Washington 99301 (509) 547-1121

Materials Engineering and Testing • Construction Inspection • Project Consultation

REPORT TO: Fausett Mine Services
P.O. Box 968
Osborn, ID 83849

DATE: 6-26-91
FILE NUMBER: 91-53
SHEET: 6 of 6
INVOICE: T910279

PROJECT: Lower Monumental Dam

Sample Identification

On May 29, 1991, your personnel delivered to our laboratory shotcrete cores. It was reported that the test panels were shot on May 22, 1991, by your operator, Cunningham. The panels were reportedly shot at horizontal position, using mix #1 (7.5 bag mix with 8X silica flume).

At your request, we performed compressive strength tests in accordance with ASTM C42. The test results are as follows.

Test Results

Lab Number	Date Tested	Age	<u>Length</u> Diameter	Compressive Strength PSI
911871	6-17-91	26	<u>6.25</u> 2.75	5920
911872	6-17-91	26	<u>6.125</u> 2.75	5860
911873	6-19-91	28	<u>3.875</u> 2.75	6130
911874	6-19-91	28	<u>4.625</u> 2.75	6120

Reviewed by Lew A. Beck

SOUTH DAKOTA CEMENT

1360
13th Street
SD 57709-0360

AMERICAN OWNED & OPERATED

Phone (605) 342-4752
FAX (605) 342-4742

To: Connell Sand & Gravel Inc.
P.O. Box 156
Connell, Wy. 99326

Re: DACW68-91-C-0002
Franklin Co. Lower Monumental
Permanent Juvenile Fish
Bypass Facility

CERTIFICATION OF COMPLIANCE:

This is to certify that all Dakota Type I-II LA Portland Cement shipped to you meets or exceeds the quality standards set forth by the American Society for Testing and Materials (ASTM C - 150 - 89).

Questions concerning these specifications may be directed to this office at the above number.

HARCON INCORPORATED P.O. BOX 480 KARLOUTUS, WA. 99339-0480	
LOWER MONUMENTAL PERMANENT JUVENILE FISH BYPASS FACILITY	
FRANKLIN COUNTY WASHINGTON Contract No. DACW 68-91-C-0002	
<input checked="" type="checkbox"/> Reviewed	
<input type="checkbox"/> Reviewed As Noted Resubmit	
<input type="checkbox"/> Rejected, Resubmittal Required	
<input checked="" type="checkbox"/> Approved	
Signature	<i>M. L. ...</i>
Date	<u>1/31/91</u>
Item No.	<u>1</u>
Transmittal No.	<u>3A-02</u>

Court Patterson
Signature
Quality Control Manager
30 January, 1991
Date

RECEIVED	
CONSTRUCTION DIV. WALLA WALLA DIST.	
Sig:	<i>Jr f</i>
Date:	<u>26 FEB 1991</u>

3A 6111

91-02---3A-002---1



Post-It™ brand fax transmittal memo 7671 1 of pages -

To	From <i>D. Bakke</i>
Co. <i>Connell</i>	Co. <i>SA</i>
Dept.	Phone # <i>605-312-4250</i>
Fax # <i>605-312-3437</i>	Fax # <i>605-312-4742</i>

15115
3A-2
3A6.110

DATE.....1-21-91
ORDER #.....MC-921
CONSIGNED TO:.....TILBURY CEMENT

CERTIFICATE OF COMPLIANCE
DACOTAH CEMENT
RAPID CITY, SOUTH DAKOTA

CAR #	LBS.	CAR #	LBS.
BN 441440	195700		
BN 441234	197000		

DESTINATION.....PASCO, WA

TYPE: I-II LA A.B.T.M. C-150-89 DACOTAH
BIN # 39 LAB# 51915 SPECIFICATION LIMIT CEMENT

CHEMICAL	TYPE I	TYPE II	ANALYSIS
Silicon dioxide, min. % (SiO2)		20.00	22.67
Aluminum oxide, max. % (Al2O3)		6.00	4.44
Ferric oxide, max. % (Fe2O3)		6.00	3.32
Magnesium oxide, max. % (MgO)	6.00	6.00	1.12
Sulfur trioxide, max. % (SO3)			2.15
When (C3A) is 8% or less	3.00	3.00	
Loss on ignition, max. %	3.00	3.00	0.73
Insoluble residue, max. %			0.12
Tricalcium aluminate, max. % (C3A)			6.16
Alkalies, max. % (*) (as Na eq.)			0.51

RECEIVED
CONSTRUCTION DIV.
WALLA WALLA DIST.
FEB 8 1991

PHYSICAL	TYPE I	TYPE II	ANALYSIS
Blaine Fineness. (M2/Kg), min	280	280	385
Autoclave expansion, max. %	0.80	0.80	-0.02
Gillmore initial set time, min.	10:00	10:00	2:30
Gillmore final set time, max.	10:00	10:00	4:30
Vicat setting time, min, not less than	145	145	2:10
max, not more than	6:15	6:15	
3 Day Compressive Strength, p.s.i.	1800	1500	3185
7 Day Compressive Strength, p.s.i.	2800	2500	4753
28 Day Compressive Strength, p.s.i.	4000	4000	6820
Air content of mortar, volume, max. %	12.0	12.0	8.7
False set final penetration, min, (*)	50	50	

(*) Optional Requirements
This will certify that the above described shipment of DACOTAH cement meets current ASTM C150-89 and AASHTO M85 specifications. All testing complies with the requirements by A.S.T.M. for Portland Cement. WE ARE NOT RESPONSIBLE FOR ANY ADDITIVES NOT STATED IN THE CERTIFICATE OF COMPLIANCE.

DATE OF REPORT....01/22/91 CHEMIST.. Court Patterson

C3S..... 48.16
C4AF..... 10.11

91-02---3A-002----2

Master Builders Technologies



Master Builders, Inc.

23700 Chevrin Boulevard
Cleveland, Ohio 44122-5854
Phone 216/831-6600
Telex 980-306

June 12, 1991

Certificate of Quality
Master Builders Raw Silica Fume Mineral Admixture (West Coast Source)

Re: Corps. of Engineers Projects

TO WHOM IT MAY CONCERN:

State of Ohio }
County of Lake } ss

Before me, a Notary Public, in and for the aforesaid State and County, personally appeared Brian E. Caine, who being duly sworn, deposes and says:

That he is Manager, Chemistry Laboratory for Master Builders, Inc., Cleveland, Ohio; and

That Raw Silica Fume Mineral Admixture (West Coast Source) is Master Builders dry uncompactd silica fume mineral admixture for improving the properties of hardened concrete, especially strength and impermeability; and

That Raw Silica Fume Mineral Admixture (West Coast Source) meets the following Master Builders quality assurance acceptance criteria:

Silicon dioxide (SiO ₂), min, %	85.0
Available alkalis, as Na ₂ O, max, %	1.5
Moisture content, max, %	3.0
Loss on ignition, max, %	6.0
Amount retained on U.S. No. 325 Sieve, max, %	10.0*
Pozzolanic Activity**	Not Tested
Uniformity of Density***	Not Tested

- * Recent production runs have shown retained amounts of less than 5%.
- ** Silica Fume containing more than 85% SiO₂ is certainly pozzolanic. Pozzolanic activity was developed to test the effectiveness of fly ash and has no meaning with silica fume.
- *** Master Builders does not use density as a measure of uniformity. This silica fume is from a furnace in which only one metal product is made. This test has more meaning for fly ash than silica fume.

Subscribed and sworn to before me
this 12th day of June, 1991

Brian E. Caine
Manager, Chemistry Laboratory
Admixture Research & Development

Robert C. Miller
Robert C. Miller, Notary Public
State of Ohio
My Commission Expires February 7, 1996
(Recorded in Lake County)

Doc. 5325