



Online Continuing Education for Professional Engineers
Since 2009

Engineering Uses of Geotextiles

PDH Credits:

6 PDH

Course No.:

EUG101

Publication Source:

US Corp of Engineers

"Unified Facilities Criteria: Engineering Uses of Geotextiles"

Pub. # UFC 3-220-08FA

Release Date:

Jan. 2004

DISCLAIMER:

All course materials available on this website are not to be construed as a representation or warranty on the part of Online-PDH, or other persons and/or organizations named herein. All course literature is for reference purposes only, and should not be used as a substitute for competent, professional engineering council. Use or application of any information herein, should be done so at the discretion of a licensed professional engineer in that given field of expertise. Any person(s) making use of this information, herein, does so at their own risk and assumes any and all liabilities arising therefrom.

UNIFIED FACILITIES CRITERIA (UFC)

ENGINEERING USE OF GEOTEXTILES



APPROVED FOR PUBLIC RELEASE; DISTRIBUTION UNLIMITED

UNIFIED FACILITIES CRITERIA (UFC)
ENGINEERING USE OF GEOTEXTILES

Any copyrighted material included in this UFC is identified at its point of use. Use of the copyrighted material apart from this UFC must have the permission of the copyright holder.

U.S. ARMY CORPS OF ENGINEERS (Preparing Activity)

NAVAL FACILITIES ENGINEERING COMMAND

AIR FORCE CIVIL ENGINEER SUPPORT AGENCY

Record of Changes (changes are indicated by \1\ ... /1/)

Change No.	Date	Location

This UFC supersedes TM 5-818-8, dated 20 July 1995. The format of this UFC does not conform to UFC 1-300-01; however, the format will be adjusted to conform at the next revision. The body of this UFC is the previous TM 5-818-8, dated 20 July 1995.

FOREWORD

\1\

The Unified Facilities Criteria (UFC) system is prescribed by MIL-STD 3007 and provides planning, design, construction, sustainment, restoration, and modernization criteria, and applies to the Military Departments, the Defense Agencies, and the DoD Field Activities in accordance with [USD\(AT&L\) Memorandum](#) dated 29 May 2002. UFC will be used for all DoD projects and work for other customers where appropriate. All construction outside of the United States is also governed by Status of forces Agreements (SOFA), Host Nation Funded Construction Agreements (HNFA), and in some instances, Bilateral Infrastructure Agreements (BIA.) Therefore, the acquisition team must ensure compliance with the more stringent of the UFC, the SOFA, the HNFA, and the BIA, as applicable.

UFC are living documents and will be periodically reviewed, updated, and made available to users as part of the Services' responsibility for providing technical criteria for military construction. Headquarters, U.S. Army Corps of Engineers (HQUSACE), Naval Facilities Engineering Command (NAVFAC), and Air Force Civil Engineer Support Agency (AFCESA) are responsible for administration of the UFC system. Defense agencies should contact the preparing service for document interpretation and improvements. Technical content of UFC is the responsibility of the cognizant DoD working group. Recommended changes with supporting rationale should be sent to the respective service proponent office by the following electronic form: [Criteria Change Request \(CCR\)](#). The form is also accessible from the Internet sites listed below.

UFC are effective upon issuance and are distributed only in electronic media from the following source:

- Whole Building Design Guide web site <http://dod.wbdg.org/>.

Hard copies of UFC printed from electronic media should be checked against the current electronic version prior to use to ensure that they are current.

AUTHORIZED BY:



DONALD L. BASHAM, P.E.
Chief, Engineering and Construction
U.S. Army Corps of Engineers



DR. JAMES W. WRIGHT, P.E.
Chief Engineer
Naval Facilities Engineering Command

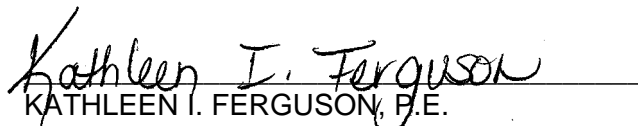

KATHLEEN I. FERGUSON, P.E.
The Deputy Civil Engineer
DCS/Installations & Logistics
Department of the Air Force



Dr. GET W. MOY, P.E.
Director, Installations Requirements and
Management
Office of the Deputy Under Secretary of Defense
(Installations and Environment)

ARMY TM 5-818-8
AIR FORCE AFJMAN 32-1030

TECHNICAL MANUAL

ENGINEERING USE OF GEOTEXTILES

APPROVED FOR PUBLIC RELEASE; DISTRIBUTION IS UNLIMITED

DEPARTMENTS OF THE ARMY AND THE AIR FORCE
20 July 1995

REPRODUCTION AUTHORIZATION/RESTRICTIONS

This manual has been prepared by or for the Government and, except to the extent indicated below, is public property and not subject to copyright.

Reprints or republications of this manual should include a credit substantially as follows: "Joint Departments of the Army and Air Force, TM 5-818-8/AFJMAN 32-1030, Engineering Use of Geotextiles," 20 July 1995.

TECHNICAL MANUAL
 No. 5-818-8
 AIR FORCE MANUAL
 No. 32-1030

HEADQUARTERS
 DEPARTMENTS OF THE ARMY
 AND THE AIR FORCE
 WASHINGTON, DC, 20 July 1995

ENGINEERING USE OF GEOTEXTILES

	Paragraph	Page
CHAPTER 1. INTRODUCTION		
Purpose.....	1-1	1-1
Scope	1-2	1-1
References	1-3	1-1
Geotextile Types and Construction.....	1-4	1-1
Geotextile Durability	1-5	1-2
Seam Strength	1-6	1-2
Geotextile Functions and Applications	1-7	1-3
2. GEOTEXTILES IN PAVEMENT APPLICATIONS		
Applications	2-1	2-1
Paved Surface Rehabilitation.....	2-2	2-1
Reflective Crack Treatment for Pavements	2-3	2-1
Separation and Reinforcement	2-4	2-2
Design for Separation	2-5	2 4
Geotextile Survivability.....	2-6	2 4
Design for Reinforcement	2-7	2-4
3. FILTRATION AND DRAINAGE		
Water Control.....	3-1	3-1
Granular Drain Performance.....	3-2	3-1
Geotextile Characteristics Influencing Filter Functions	3-3	3-1
Piping Resistance.....	3 4	3-1
Permeability	3-5	3-2
Other Filter Considerations	3-6	3-3
Strength Requirements.....	3-7	3-4
Design and Construction Considerations.....	3-8	3-4
4. GEOTEXTILE REINFORCED EMBANKMENT ON SOFT FOUNDATION		
General	4-1	4-1
Potential Embankment Failure Modes	4-2	4-1
Recommended Criteria	4-3	4-3
Example Geotextile-Reinforced Embankment Design.....	4 4	4-7
Bearing-Capacity Consideration.....	4-5	4-8
5. RAILROAD TRACK CONSTRUCTION AND REHABILITATION		
General	5-1	5-1
Material Selection	5-2	5-1
Application.....	5-3	5-1
Depth of Placement	5 4	5-1
Protective Sand Layer	5-5	5-2
Drainage	5-6	5-3
Typical Sections	5-7	5-3
Special Applications	5-8	5-3
6. EROSION AND SEDIMENT CONTROL		
Erosion Control.....	6-1	6-1
Bank Erosion.....	6-2	6-1
Precipitation Runoff Collection and Diversion Ditches.....	6-3	6-3
Miscellaneous Erosion Control.....	6 4	6-3
Sediment Control.....	6-5	6-4
7. REINFORCED SOIL WALLS		
Geotextile-Reinforced Soil Walls	7-1	7-1
Advantages of Geotextile-Reinforced Walls	7-2	7-1
Disadvantages of Geotextile-Reinforced Walls.....	7-3	7-1
Uses	7 4	7-1
General Considerations	7-5	7-1
Properties of Materials.....	7-6	7-2
Design Method	7-7	7-3
Design Procedure.....	7-8	7-3

	Paragraph	Page
APPENDIX A. REFERENCES		A-1
BIBLIOGRAPHY	BIBLIOGRAPHY-1	

LIST OF FIGURES

Figure	1-1 Dimensions and Directions for Woven Geotextiles.	1-2
	1-2. Woven Monofilament Geotextiles Having Low Percent Open Area (Top), and High Percent Open Area (Bottom).	1-3
	1-3. Woven Multifilament Geotextile.	1-4
	1-4. Woven Slit-Film Geotextile.	1-4
	1-5. Needle-Punched Nonwoven Geotextile.	1-5
	1-6. Heat-Bonded Nonwoven Geotextile.	1-6
	1-7. Seam Types Used in Field Seaming of Geotextiles.	1-7
	1-8. Stitch Types Used in Field Seaming of Geotextiles.	1-8
	2-1. Geotextile in AC Overlay.	2-2
	2-2. Guidance for Geotextile Use in Minimizing Reflective Cracking.	2-3
	2-3. Relationship Between Shear Strength, CBR, and Cone Index.	2-6
	2-4. Thickness Design Curve for Single-Wheel Load on Gravel-Surfaced Roads.	2-7
	2-5. Thickness Design Curve for Dual-Wheel Load on Gravel- Surfaced Roads.	2-8
	2-6. Thickness Design Curve for Tandem-Wheel Load on Gravel-Surfaced Roads.	2-9
	3-1. Trench Drain Construction.	3-5
	4-1. Potential Geotextile-Reinforced Embankment Failure Modes.	4-2
	4-2. Concept Used for Determining Geotextile Tensile Strength Necessary to Prevent Slope Failure.	4-4
	4-3. Assumed Stresses and Strains Related to Lateral Earth Pressures.	4-7
	4-4. Embankment Section and Foundation Conditions of Embankment Design Example Problem.	
	5-1. Typical Sections of Railroad Track with Geotextile.	5-4
	6-1. Relationship between Atterberg Limits and Expected Erosion Potential.	6-2
	6-2. Pin Spacing Requirements in Erosion Control Applications.	6-3
	6-3. Geotextile Placement for Currents Acting Parallel to Bank or for Wave Attack on the Bank.	6-4
	6-4. Ditch Liners.	6-5
	6-5. Use of Geotextiles near Small Hydraulic Structures.	6-6
	6-6. Use of Geotextiles around Piers and Abutments.	6-6
	6-7. Sedimentation behind Silt Fence.	6-7
	7-1. General Configuration of a Geotextile Retained Soil Wall and Typical Pressure Diagrams.	7-2
	7-2. Procedures for Computing Live Load Stresses on Geotextile Reinforced Retaining Walls.	7-4

LIST OF TABLES

Table	2-1. Property Requirements of Nonwoven Geotextiles.	2-3
	2-2. Construction Survivability Ratings (FHWA 1989).	2-4
	2-3. Relationship of Construction Elements to Severity of Loading Imposed on Geotextile in Roadway Construction (FHWA 1989).	2-5
	2-4. Minimum Geotextile Strength Properties for Survivability (FHWA 1989).	2-5
	3-1. Geotextile Filter Design Criteria.	3-1
	3-2. Geotextile Strength Requirements for Drains.	3-4
	5-1. Recommended Geotextile Property Requirements for Railroad Applications.	5-2
	6-1. Recommended Geotextile Minimum Strength Requirements.	6-2
	6-2. Pin Spacing Requirements in Erosion Control Applications.	6-3

CHAPTER 1

INTRODUCTION

1-1. Purpose

This manual describes various geotextiles, test methods for evaluating their properties, and recommended design and installation procedures.

1-2. Scope

This manual covers physical properties, functions, design methods, design details and construction procedures for geotextiles as used in pavements, railroad beds, retaining wall earth embankment, rip-rap, concrete revetment, and drain construction. Geotextile functions described include pavements, filtration and drainage, reinforced embankments, railroads, erosion and sediment control, and earth retaining walls. This manual does not cover the use of other geosynthetics such as geogrids, geonets, geomembranes, plastic strip drains, composite products and products made from natural cellulose fibers.

1-3. References

Appendix A contains a list of references used in this manual.

1-4. Geotextile Types and Construction

a. Materials. Geotextiles are made from polypropylene, polyester, polyethylene, polyamide (nylon), polyvinylidene chloride, and fiberglass. Polypropylene and polyester are the most used. Sewing thread for geotextiles is made from Kevlar¹ or any of the above polymers. The physical properties of these materials can be varied by the use of additives in the composition and by changing the processing methods used to form the molten material into filaments. Yarns are formed from fibers which have been bundled and twisted together, a process also referred to as spinning. (This reference is different from the term spinning as used to denote the process of extruding filaments from a molten material.) Yarns may be composed of very long fibers (filaments) or relatively short pieces cut from filaments (staple fibers).

b. Geotextile Manufacture.

(1) In woven construction, the warp yarns, which run parallel with the length of the geotextile panel (machine direction), are interlaced with yarns called fill or filling yarns, which run perpendicular to the length of the panel (cross direction

as shown in fig 1-1). Woven construction produces geotextiles with high strengths and moduli in the warp and fill directions and low elongations at rupture. The modulus varies depending on the rate and the direction in which the geotextile is loaded. When woven geotextiles are pulled on a bias, the modulus decreases, although the ultimate breaking strength may increase. The construction can be varied so that the finished geotextile has equal or different strengths in the warp and fill directions. Woven construction produces geotextiles with a simple pore structure and narrow range of pore sizes or openings between fibers. Woven geotextiles are commonly plain woven, but are sometimes made by twill weave or leno weave (a very open type of weave). Woven geotextiles can be composed of monofilaments (fig 1-2) or multifilament yarns (fig 1-3). Multifilament woven construction produces the highest strength and modulus of all the constructions but are also the highest cost. A monofilament variant is the slit-film or ribbon filament woven geotextile (fig 1-4). The fibers are thin and flat and made by cutting sheets of plastic into narrow strips. This type of woven geotextile is relatively inexpensive and is used for separation, i.e., the prevention of intermixing of two materials such as aggregate and fine-grained soil.

(2) Manufacturers literature and textbooks should be consulted for greater description of woven and knitted geotextile manufacturing processes which continue to be expanded.

(3) Nonwoven geotextiles are formed by a process other than weaving or knitting, and they are generally thicker than woven products. These geotextiles may be made either from continuous filaments or from staple fibers. The fibers are generally oriented randomly within the plane of the geotextile but can be given preferential orientation. In the spunbonding process, filaments are extruded, and laid directly on a moving belt to form the mat, which is then bonded by one of the processes described below.

(a) Needle punching. Bonding by needle punching involves pushing many barbed needles through one or several layers of a fiber mat normal to the plane of the geotextile. The process causes the fibers to be mechanically entangled (fig 1-5). The resulting geotextile has the appearance of a felt mat.

(b) Heat bonding. This is done by incorpo-

¹ Kevlar is a registered trademark of Du Pont for their aramid fiber.

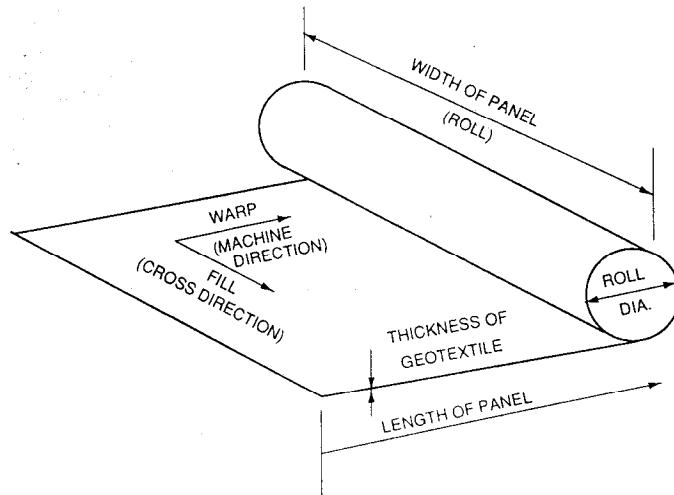

Figure 1-1. Dimensions and Directions for Woven Geotextiles.

rating fibers of the same polymer type but having different melting points in the mat, or by using heterofilaments, that is, fibers composed of one type of polymer on the inside and covered or sheathed with a polymer having a lower melting point. A heat-bonded geotextile is shown in figure 1-6.

(c) *Resin bonding.* Resin is introduced into the fiber mat, coating the fibers and bonding the contacts between fibers.

(d) *Combination bonding.* Sometimes a combination of bonding techniques is used to facilitate manufacturing or obtain desired properties.

(4) Composite geotextiles are materials which combine two or more of the fabrication techniques. The most common composite geotextile is a non-woven mat that has been bonded by needle punching to one or both sides of a woven scrim.

1-5. Geotextile Durability

Exposure to sunlight degrades the physical properties of polymers. The rate of degradation is reduced by the addition of carbon black but not eliminated. Hot asphalt can approach the melting point of some polymers. Polymer materials become brittle in very cold temperatures. Chemicals in the groundwater can react with polymers. All polymers gain water with time if water is present. High pH water can be harsh on polyesters while low pH water can be harsh on polyamides. Where a chemically unusual environment exists, laboratory test data on effects of exposure of the geotextile to this environment should be sought. Experience with geotextiles in place spans only about 30 years. All of these factors should be considered in selecting or specifying acceptable geotextile materials. Where long duration integrity of the material is critical to life safety and where the in-place

material cannot easily be periodically inspected or easily replaced if it should become degraded (for example filtration and/or drainage functions within an earth dam), current practice is to use only geologic materials (which are orders of magnitude more resistant to these weathering effects than polyesters).

1-6. Seam Strength

a. *Joining Panels.* Geotextile sections can be joined by sewing, stapling, heat welding, tying, and gluing. Simple overlapping and staking or nailing to the underlying soil may be all that is necessary where the primary purpose is to hold the material in place during installation. However, where two sections are joined and must withstand tensile stress or where the security of the connection is of prime importance, sewing is the most reliable joining method.

b. *Sewn Seams.* More secure seams can be produced in a manufacturing plant than in the field. The types of sewn seams which can be produced in the field by portable sewing machines are presented in figure 1-7. The seam type designations are from Federal Standard 751. The SSa seam is referred to as a "prayer" seam, the SSn seam as a "J" seam, and the SSd as a "butterfly" seam. The double-sewn seam, SSa-2, is the preferred method for salvageable geotextiles. However, where the edges of the geotextile are subject to unraveling, SSd or SSn seams are preferred.

c. *Stitch Type.* The portable sewing machines used for field sewing of geotextiles were designed as bag closing machines. These machines can produce either the single-thread or two-thread chain stitches as shown in figure 1-8. Both of these stitches are subject to unraveling, but the single-thread stitch is much more susceptible and

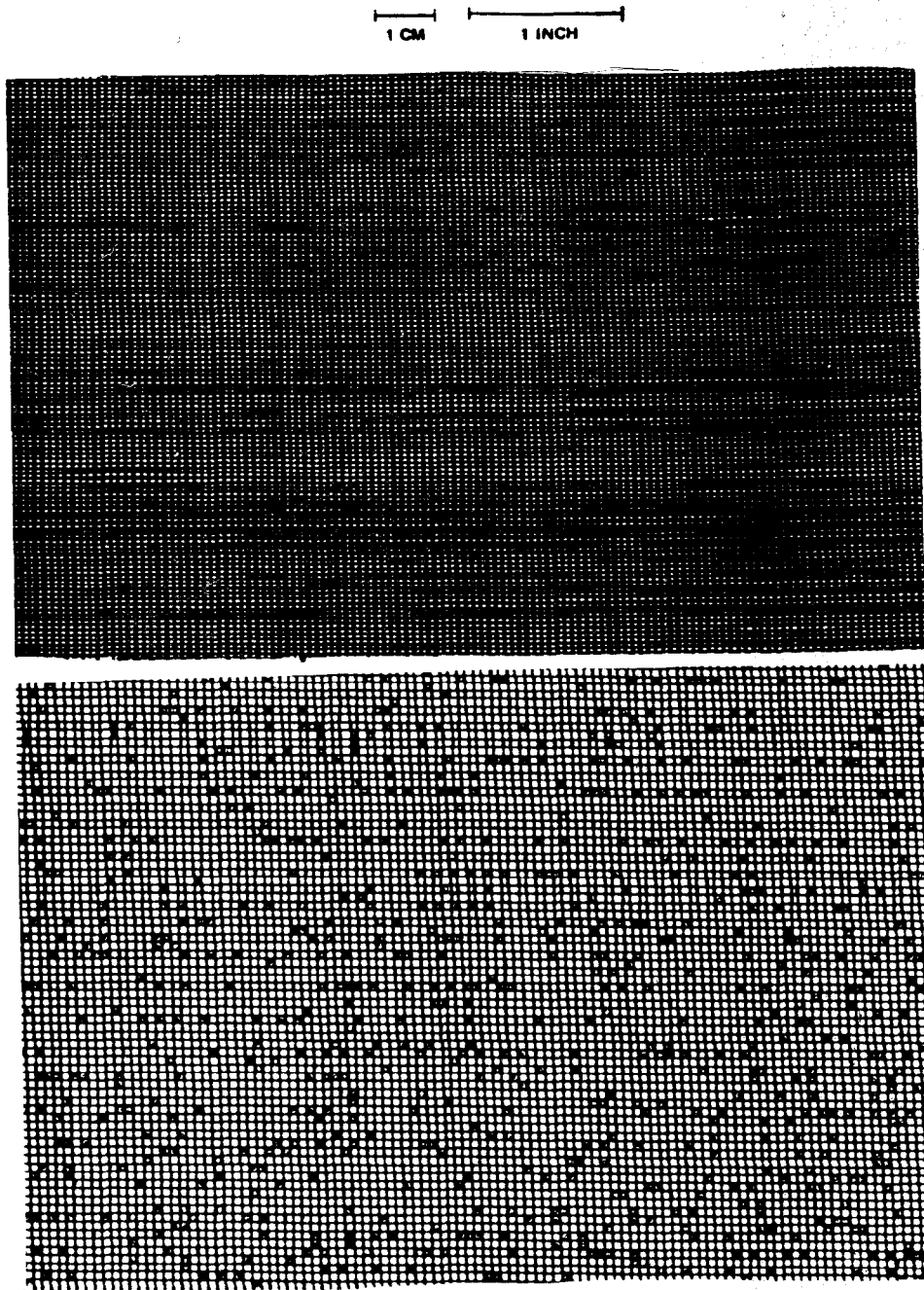

Figure 1-2. Woven Monofilament Geotextiles Having Low Percent Open Area (Top), and High Percent Open Area (Bottom)

must be tied at the end of each stitching. Two rows of stitches are preferred for field seaming, and two rows of stitches are absolutely essential for secure seams when using the type 101 stitch since, with this stitch, skipped stitches lead to complete unraveling of the seam. Field sewing should be conducted so all stitching is exposed for inspection. Any skipped stitches should be over-sewn.

d. Sewing Thread. The composition of the thread should meet the same compositional performance requirements as the geotextile itself, al-

though it may be desirable to permit the thread to be made of a material different from the geotextile being sewn. Sewing thread for geotextiles is usually made from Kevlar, polyester, polypropylene, or nylon with the first two recommended despite their greater expense. Where strong seams are required, Kevlar sewing thread provides very high strength with relative ease of sewing.

1-7 Geotextile Functions and Applications.

a. Functions. Geotextiles perform one or more basic functions: filtration, drainage, separation,

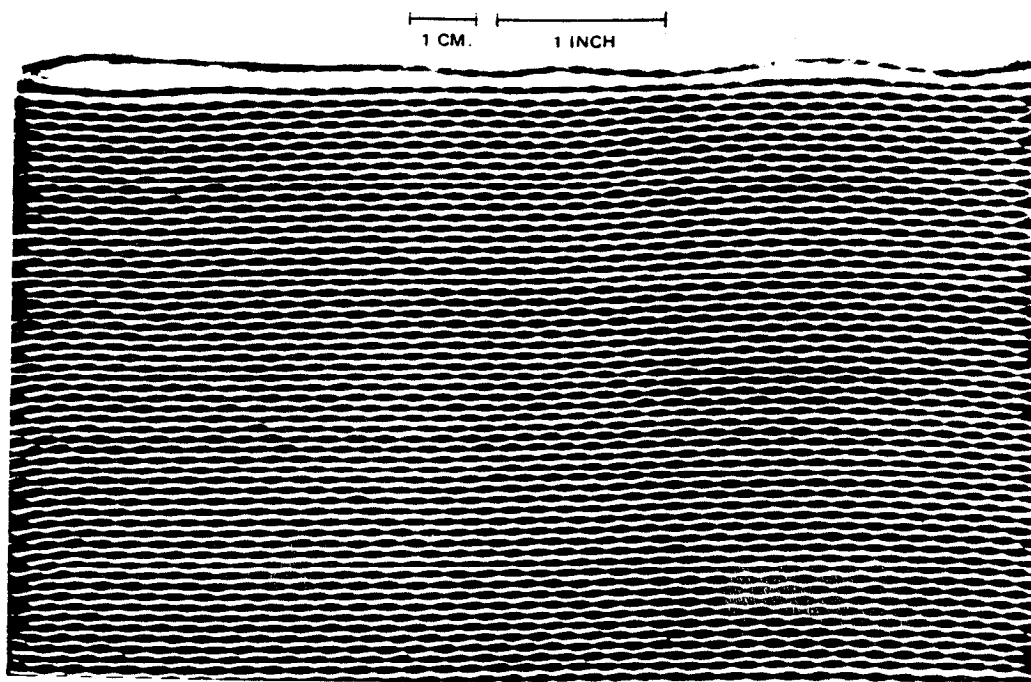

Figure 1-3. Woven Multifilament Geotextile.

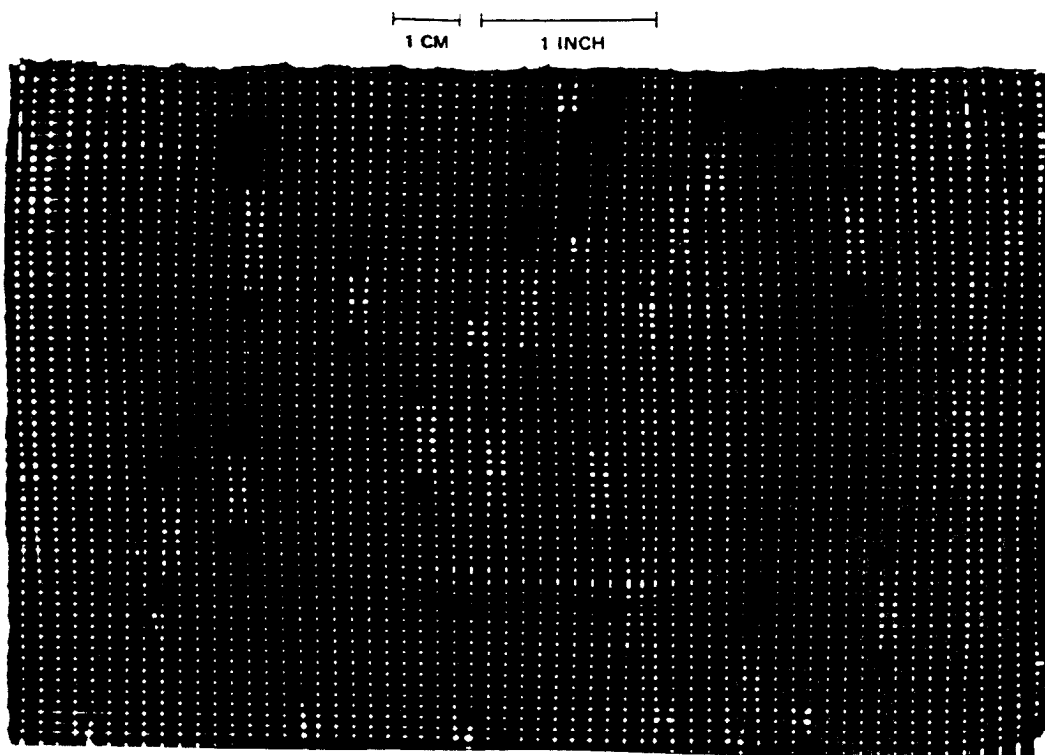

Figure 1-4. Woven Slit-Film Geotextile.

erosion control, sediment control, reinforcement, and (when impregnated with asphalt) moisture barrier. In any one application, a geotextile may be performing several of these functions.

b. Filtration. The use of geotextiles in filter applications is probably the oldest, the most widely known, and the most used function of geotextiles. In this application, the geotextile is

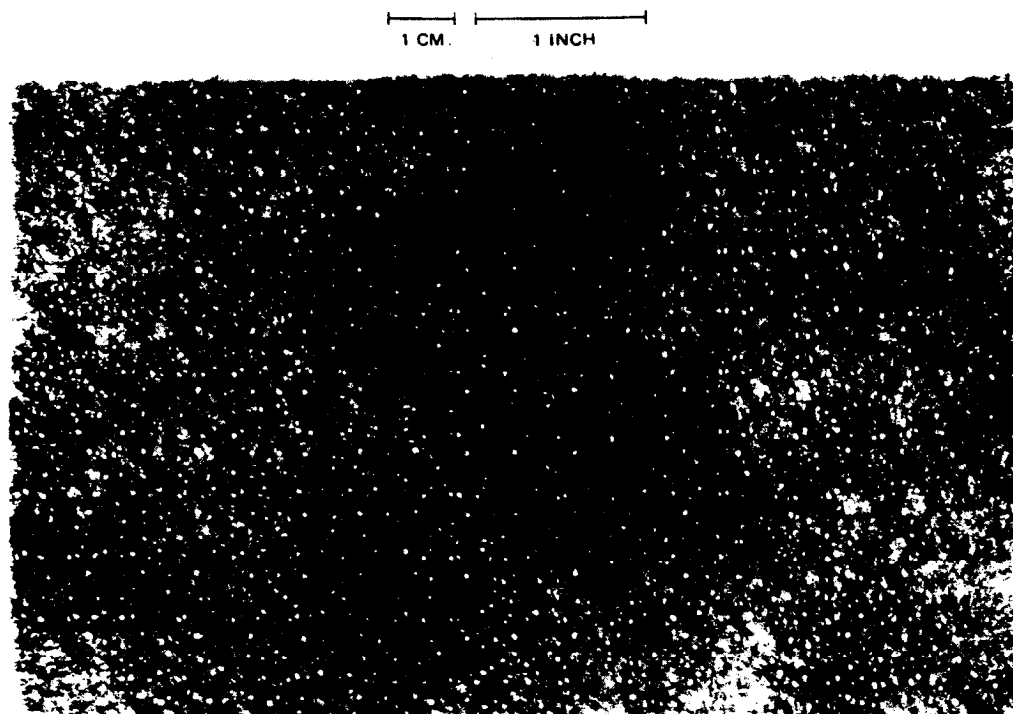

Figure 1-5. Needle-Punched Nonwoven Geotextile.

placed in contact with and down gradient of soil to be drained. The plane of the geotextile is normal to the expected direction of water flow. The capacity for flow of water normal to the plane of the geotextile is referred to as permittivity. Water and any particles suspended in the water which are smaller than a given size flow through the geotextile. Those soil particles larger than that size are stopped and prevented from being carried away. The geotextile openings should be sized to prevent soil particle movement. The geotextiles substitute for and serve the same function as the traditional granular filter. Both the granular filter and the geotextile filter must allow water (or gas) to pass without significant buildup of hydrostatic pressure. A geotextile-lined drainage trench along the edge of a road pavement is an example using a geotextile as a filter. Most geotextiles are capable of performing this function. Slit film geotextiles are not preferred because opening sizes are unpredictable. Long term clogging is a concern when geotextiles are used for filtration.

c. Drainage. When functioning as a drain, a geotextile acts as a conduit for the movement of liquids or gases in the plane of the geotextile. Examples are geotextiles used as wick drains and blanket drains. The relatively thick nonwoven geotextiles are the products most commonly used. Selection should be based on transmissivity, which is the capacity for in-plane flow. Questions exist as

to long term clogging potential of geotextile drains. They are known to be effective in short duration applications.

d. Erosion Control. In erosion control, the geotextile protects soil surfaces from the tractive forces of moving water or wind and rainfall erosion. Geotextiles can be used in ditch linings to protect erodible fine sands or cohesionless silts. The geotextile is placed in the ditch and is secured in place by stakes or is covered with rock or gravel to secure the geotextile, shield it from ultraviolet light, and dissipate the energy of the flowing water. Geotextiles are also used for temporary protection against erosion on newly seeded slopes. After the slope has been seeded, the geotextile is anchored to the slope holding the soil and seed in-place until the seeds germinate and vegetative cover is established. The erosion control function can be thought of as a special case of the combination of the filtration and separation functions.

e. Sediment Control. A geotextile serves to control sediment when it stops particles suspended in surface fluid flow while allowing the fluid to pass through. After some period of time, particles accumulate against the geotextile, reducing the flow of fluid and increasing the pressure against the geotextile. Examples of this application are silt fences placed to reduce the amount of sediment carried off construction sites and into nearby

water courses. The sediment control function is actually a filtration function.

f. Reinforcement. In the most common reinforcement application, the geotextile interacts with soil through frictional or adhesion forces to resist tensile or shear forces. To provide reinforcement, a geotextile must have sufficient strength and embedment length to resist the tensile forces generated, and the strength must be developed at sufficiently small strains (i.e. high modulus) to prevent excessive movement of the reinforced structure. To reinforce embankments and retaining structures, a woven geotextile is recommended because it can provide high strength at small strains.

g. Separation. Separation is the process of preventing two dissimilar materials from mixing. In this function, a geotextile is most often required to prevent the undesirable mixing of fill and natural soils or two different types of fills. A geotextile can be placed between a railroad subgrade and track

ballast to prevent contamination and resulting strength loss of the ballast by intrusion of the subgrade soil. In construction of roads over soft soil, a geotextile can be placed over the soft subgrade, and then gravel or crushed stone placed on the geotextile. The geotextile prevents mixing of the two materials.

h. Moisture Barrier. Both woven and nonwoven geotextiles can serve as moisture barriers when impregnated with bituminous, rubber-bitumen, or polymeric mixtures. Such impregnation reduces both the cross-plane and in-plane flow capacity of the geotextiles to a minimum. This function plays an important role in the use of geotextiles in paving overlay systems. In such systems, the impregnated material seals the existing pavement and reduces the amount of surface water entering the base and subgrade. This prevents a reduction in strength of these components and improves the performance of the pavement system.

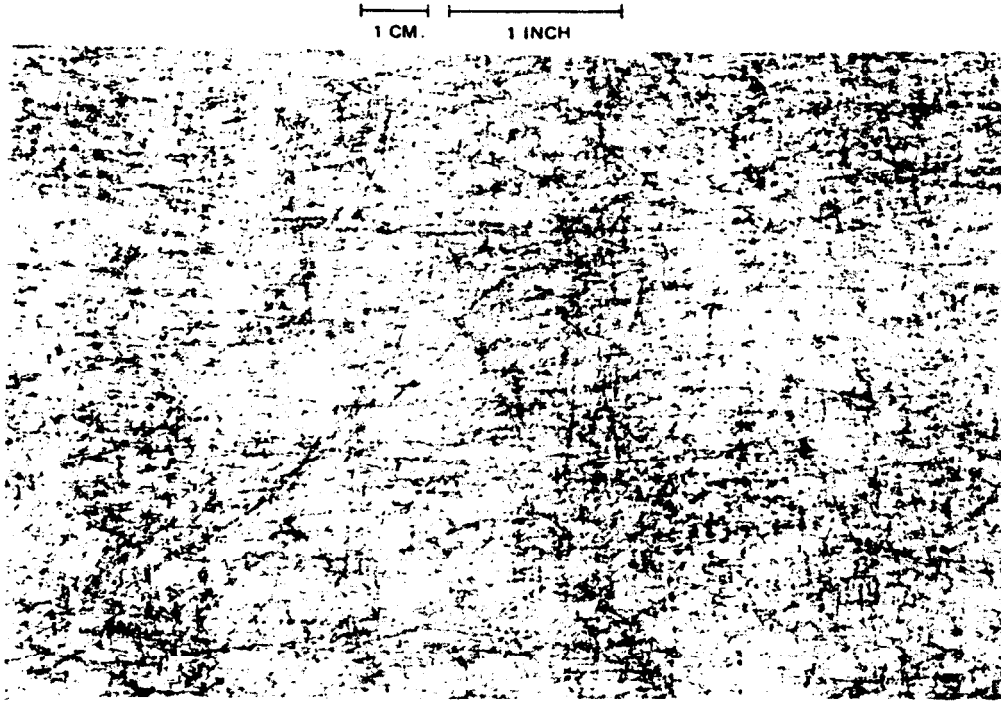
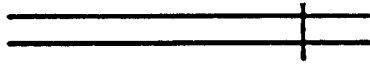

Figure 1-6. Heat-Bonded Nonwoven Geotextile.



SSa-1



SSa-2

PRAYER SEAM

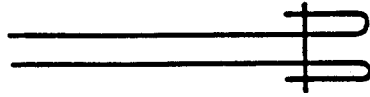

SSd-1

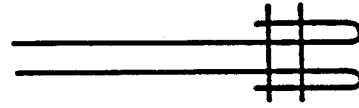

SSd-2

BUTTERFLY SEAM

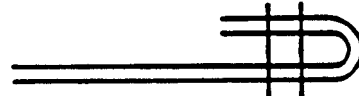

SSn-2

J SEAM

Figure 1-7. Seam Types Used in Field Seaming of Geotextiles.

DIRECTION OF SUCCESSIVE STITCH FORMATION

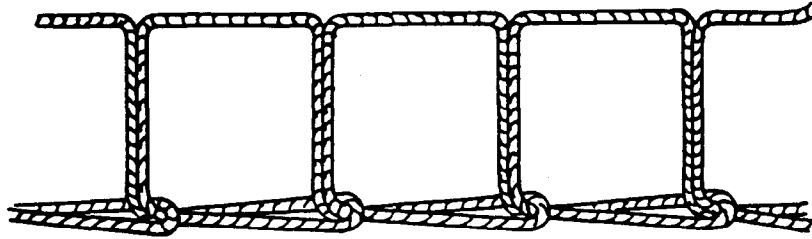

STITCH TYPE 101. ONE-THREAD CHAIN STITCH

DIRECTION OF SUCCESSIVE STITCH FORMATION

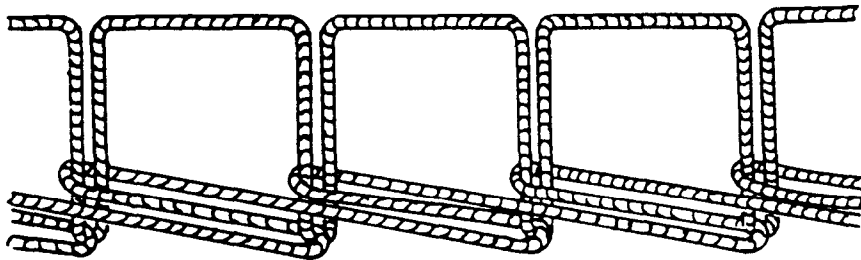
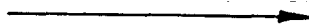

STITCH TYPE 401, TWO-THREAD CHAIN STITCH

Figure 1-8. Stitch Types Used in Field Seaming of Geotextiles.

CHAPTER 2

GEOTEXTILES IN PAVEMENT APPLICATIONS

2-1. Applications

This chapter discusses the use of geotextiles for asphalt concrete (AC) overlays on roads and airfields and the separation and reinforcement of materials in new construction. The functions performed by the geotextile and the design considerations are different for these two applications. In an AC pavement system, the geotextile provides a stress-relieving interlayer between the existing pavement and the overlay that reduces and retards reflective cracks under certain conditions and acts as a moisture barrier to prevent surface water from entering the pavement structure. When a geotextile is used as a separator, it is placed between the soft subgrade and the granular material. It acts as a filter to allow water but not fine material to pass through it, preventing any mixing of the soft soil and granular material under the action of the construction equipment or subsequent traffic.

2-2. Paved Surface Rehabilitation

a. General. Old and weathered pavements contain transverse and longitudinal cracks that are both temperature and load related. The method most often used to rehabilitate these pavements is to overlay the pavement with AC. This temporarily covers the cracks. After the overlay has been placed, any lateral or vertical movement of the pavement at the cracks due to load or thermal effects causes the cracks from the existing pavement to propagate up through the new AC overlay (called reflective cracking). This movement causes raveling and spalling along the reflective cracks and provides a path for surface water to reach the base and subgrade which decreases the ride quality and accelerates pavement deterioration.

b. Concept. Under an AC overlay, a geotextile may provide sufficient tensile strength to relieve stresses exerted by movement of the existing pavement. The geotextile acts as a stress-relieving interlayer as the cracks move horizontally or vertically. A typical pavement structure with a geotextile interlayer is shown in figure 2-1. Impregnation of the geotextile with a bitumen provides a degree of moisture protection for the underlying layers whether or not reflective cracking occurs.

2-3. Reflective Crack Treatment for Pavements

a. General. Geotextiles can be used successfully in pavement rehabilitation projects. Conditions that are compatible for the pavement applications of geotextiles are AC pavements that may have transverse and longitudinal cracks but are relatively smooth and structurally sound, and PCC pavements that have minimum slab movement. The geographic location and climate of the project site have an important part in determining whether or not geotextiles can be successfully used in pavement rehabilitation. Geotextiles have been successful in reducing and retarding reflective cracking in mild and dry climates when temperature and moisture changes are less likely to contribute to movement of the underlying pavement; whereas, geotextiles in cold climates have not been as successful. Figure 2-2 gives guidance in using geotextiles to minimize reflective cracking on AC pavements. Geotextiles interlayers are recommended for use in Areas I and II, but are not recommended for use in Area III. Since geotextiles do not seem to increase the performance of thin overlays, minimum overlay thicknesses for Areas I and II are given in figure 2-2. Even when the climate and thickness requirements are met, there has been no consistent increase in the time it takes for reflective cracking to develop in the overlay indicating that other factors are influencing performance. Other factors affecting performance of geotextile interlayers are construction techniques involving pavement preparation, asphalt sealant application, geotextile installation, and AC overlay as well as the condition of the underlying pavement.

b. Surface Preparation. Prior to using geotextiles to minimize reflective cracks, the existing pavement should be evaluated to determine pavement distress. The size of the cracks and joints in the existing pavement should be determined. All cracks and joints larger than $\frac{1}{4}$ inch in width should be sealed. Differential slab movement should be evaluated, since deflections greater than 0.002 inch cause early reflective cracks. Areas of the pavement that are structurally deficient should be repaired prior to geotextile installation. Placement of a leveling course is recommended when the existing pavement is excessively cracked and uneven.

c. Geotextile Selection.

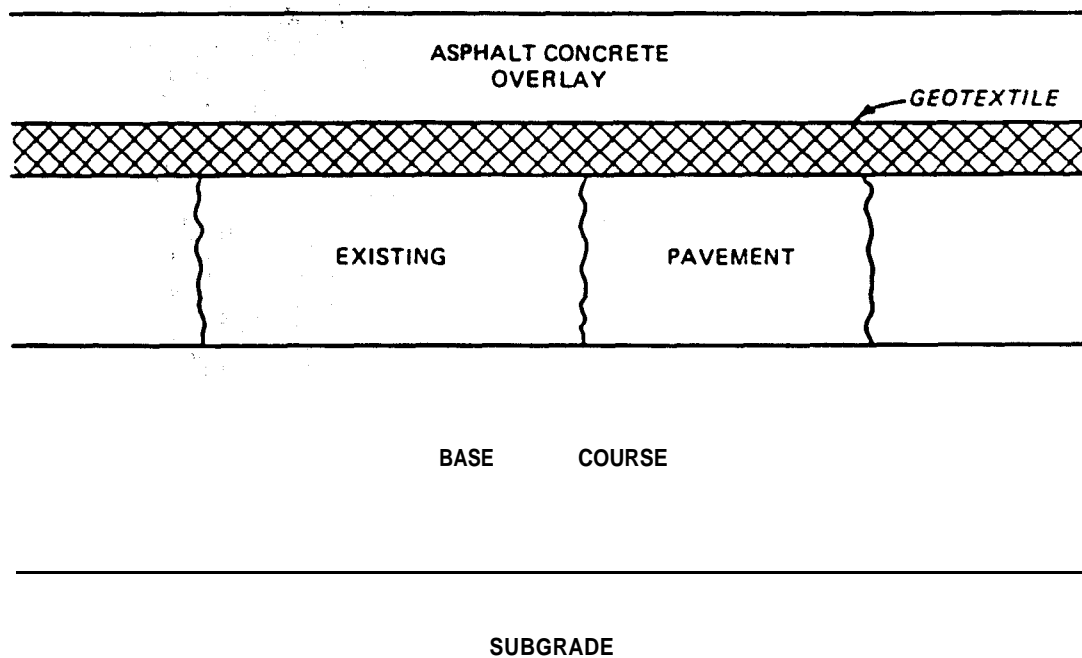

Figure 2-1. Geotextile in AC Overlay.

(1) Geotextile interlayers are used in two different capacities—the full-width and strip methods. The full-width method involves sealing cracks and joints and placing a nonwoven material across the entire width of the existing pavement. The material should have the properties shown in table 2-1. Nonwoven materials provide more flexibility and are recommended for reflective crack treatment of AC pavements.

(2) The strip method is primarily used on PCC pavements and involves preparing the existing cracks and joints, and placing a 12 to 24 inch wide geotextile and sufficient asphalt directly on the cracks and joints. The required physical properties are shown in table 2-1, however nonwoven geotextiles are not normally used in the strip method. Membrane systems have been developed for strip repairs.

d. Asphalt Sealant. The asphalt sealant is used to impregnate and seal the geotextile and bond it to both the base pavement and overlay. The grade of asphalt cement specified for hot-mix AC pavements in each geographic location is generally the most acceptable material. Either anionic or cationic emulsion can also be used. Cutback asphalts and emulsions which contain solvents should not be used.

e. AC Overlay. The thickness of the AC overlay should be determined from the pavement structural requirements outlined in TM 5-822-5/AFJMAN 32-1018, TM 5-825-2/AFJMAN 32-1014 and TM 5-825-3/AFJMAN 32-1014, Chap. 3 or from minimum requirements, which-

ever is greater. For AC pavements, Area I shown in figure 2-2 should have a minimum overlay thickness of 2 inches; whereas, Area II should have a minimum overlay thickness of 3 inches. The minimum thickness of an AC overlay for geotextile application on PCC pavements is 4 inches.

f. Spot Repairs. Rehabilitation of localized distressed areas and utility cuts can be improved with the application of geotextiles. Isolated distressed areas that are excessively cracked can be repaired with geotextiles prior to an AC overlay. Either a full-width membrane strip application can be used depending on the size of the distressed area. Localized distressed areas of existing AC pavement that are caused by base failure should be repaired prior to any pavement rehabilitation. Geotextiles are not capable of bridging structurally deficient pavements.

2-4. Separation and Reinforcement

Soft subgrade materials may mix with the granular base or subbase material as a result of loads applied to the base course during construction and/or loads applied to the pavement surface that force the granular material downward into the soft subgrade or as a result of water moving upward into the granular material and carrying the subgrade material with it. A sand blanket or filter layer between the soft subgrade and the granular material can be used in this situation. Also, the subgrade can be stabilized with lime or cement or the thickness of granular material can be in-

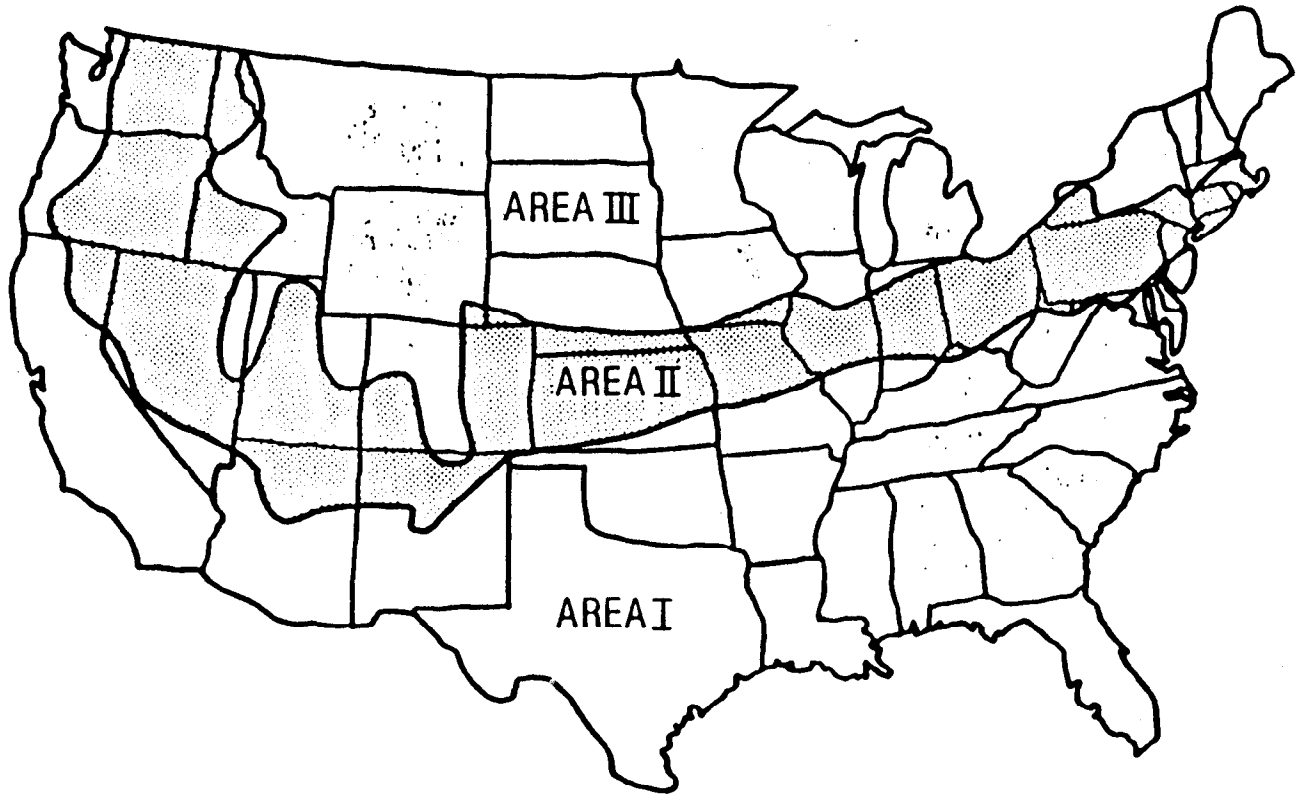

AREA I- INTERLAYERS ARE RECOMMENDED WITH MINIMUM OVERLAY THICKNESS OF 2 IN.

AREA II- INTERLAYERS ARE RECOMMENDED WITH OVERLAY THICKNESS OF 3-4 IN.

AREA III - INTERLAYERS ARE NOT RECOMMENDED.

Figure 2-2. Guidance for Geotextile Use in Minimizing Reflective Cracking.

Table 2-1. Property Requirements of Nonwoven Geotextiles.

<i>Property</i>	<i>Requirements</i>	<i>Test Method</i>
Breaking load, pounds/inch of width	80 minimum	ASTM D 4632
Elongation-at-break, percent	50 minimum	ASTM D 4632
Asphalt retention, gallons per square yard	0.2 minimum	AASHTO M288
Melting point, degrees Fahrenheit	300 minimum	ASTM D 276
Weight, ounce per square yard	3-9	ASTM D 3776 Option B

creased to reduce the stress on the subgrade. Geotextiles have been used in construction of gravel roads and airfields over soft soils to solve these problems and either increase the life of the pavement or reduce the initial cost. The placement of a permeable geotextile between the soft subgrade and the granular material may provide one or more of the following functions, (1) a filter to allow water but not soil to pass through it, (2) a

separator to prevent the mixing of the soft soil and the granular material, and (3) a reinforcement layer to resist the development of rutting. The reinforcement application is primarily for gravel surfaced pavements. The required thicknesses of gravel surfaced roads and airfields have been reduced because of the presence of the geotextile. There is no established criteria for designing gravel surfaced airfields containing a geotextile.

2-5. Design for Separation

When serving as a separator, the geotextile prevents fines from migrating into the base course and/or prevents base course aggregate from penetrating into, the subgrade. The soil retention properties of the geotextile are basically the same as those required for drainage or filtration. Therefore, the retention and permeability criteria required for drainage should be met. In addition, the geotextile should withstand the stresses resulting from the load applied to the pavement. The nature of these stresses depend on the condition of the subgrade, type of construction equipment, and the cover over the subgrade. Since the geotextile serves to prevent aggregate from penetrating the subgrade, it must meet puncture, burst, grab and tear strengths specified in the following paragraphs.

2-6. Geotextile Survivability

Table 2-2 has been developed for the Federal Highway Administration (FHWA) to consider survivability requirements as related to subgrade

conditions and construction equipment; whereas, table 2-3 relates survivability to cover material and construction equipment. Table 2-4 gives minimum geotextile grab, puncture, burst, and tear strengths for the survivability required for the conditions indicated in tables 2-2 and 2-3.

2-7. Design for Reinforcement

Use of geotextiles for reinforcement of gravel surfaced roads is generally limited to use over soft cohesive soils (CBR < 4). One procedure for determining the thickness requirements of aggregate above the geotextile was developed by the US Forest Service (Steward, et al. 1977) and is as follows:

a. *Determine In-Situ Soil Strength.* Determine the in-situ soil strength using the field California Bearing Ratio (CBR), cone penetrometer, or Vane Shear device. Make several readings and use the lower quartile value.

b. *Convert Soil Strength.* Convert the soil strength to an equivalent cohesion (C) value using the correlation shown in figure 2-3. The shear strength is equal to the C value.

Table 2-2. Construction Survivability Ratings (FHWA 1989)

Site Soil CBR at Installation	<1		1-2		>2	
	>50	<50	>50	<50	>50	<50
Equipment Ground Contact Pressure (psi)						
Cover Thickness (in.) (Compacted)						
4 ^{2,3}	NR	NR	H	M	M	M
6	NR	NR	H	H	M	M
12	NR	H	M	M	M	M
18	H	M	M	M	M	M

H = High, M = Medium, NR = Not recommended.

¹Maximum aggregate size not to exceed one half the compacted cover thickness.

²For low volume unpaved road (ADT 200 vehicles).

³The four inch minimum cover is limited to existing road bases and not intended for use in new construction.

Table 2-3. Relationship of Construction Elements to Severity of Loading Imposed on Geotextile in Roadway Construction.

Variable	Severity Category		
	LOW	Moderate	High to Very High
Equipment	Light weight dozer (8 psi)	Medium weight dozer; light wheeled equipment (8-40 psi)	Heavy weight dozer; loaded dump truck (>40 psi)
Subgrade Condition	Cleared	Partially cleared	Not cleared
Subgrade Strength (CBR)	<0.5	1-2	>3
Aggregate	Rounded sandy gravel	Coarse angular gravel	Cobbles, blasted rock
Lift Thickness (in.)	18	12	6

Table 24. Minimum Geotextile Strength Properties for Survivability.

Required Degree of Geotextile Survivability	Grab Strength ¹ lb	Puncture Strength ¹ lb	Burst Strength ³ psi	Trap Tear ⁴ lb
Very high	270	110	430	75
High	180	75	290	50
Moderate	130	40	210	40
Low	90	30	145	30

Note: All values represent minimum average roll values (i.e., any roll in a lot should meet or exceed the minimum values in this table). These values are normally 20 percent lower than manufacturers reported typical values.

¹ASTM D 4632.

¹ASTM D 4833.

³ASTM D 3786.

⁴ASTM D 4533, either principal direction.

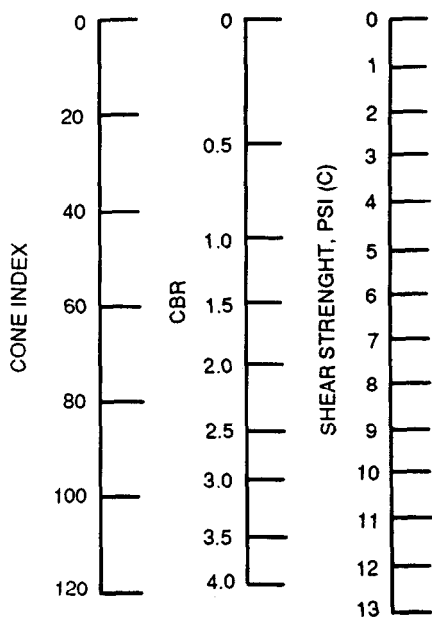

Figure 2-3. Relationship Between Shear Strength, CBR, and Cone Index.

c. *Select Design Loading.* Select the desired design loading, normally the maximum axle loads.

d. *Determine Required Thickness of Aggregate.* Determine the required thickness of aggregate above the geotextile using figures 2-4, 2-5, and 2-6. These figures relate the depth of aggregate above the geotextile to the cohesion of the soil (C) and to a bearing capacity factor (N_c). The product of C and N_c is the bearing capacity for a rapidly loaded soil without permitting drainage. The significance of the value used for N_c as it relates to the design thickness using figures 2-4, 2-5, and 2-6 is as follows:

(1) For thickness design without using geotextile.

(a) A value of 2.8 for N_c would result in a thickness design that would perform with very little rutting (less than 2 inches) at traffic volumes greater than 1,000 equivalent 18-kip axle loadings.

(b) A value of 3.3 for N_c would result in a thickness design that would rut 4 inches or more under a small amount of traffic (probably less than 100 equivalent 18-kip axle loadings).

(2) For thickness design using geotextile.

(a) A value of 5.0 for N_c would result in a thickness design that would perform with very little rutting (less than 2 inches) at traffic volumes greater than 1,000 equivalent 18-kip axle loadings.

(b) A value of 6.0 for N_c would result in a thickness design that would rut 4 inches or more under a small amount of traffic (probably less than 100 equivalent 18-kip axle loadings).

e. *Geotextile reinforced gravel road design example.* Design a geotextile reinforced gravel road for a 24,000-pound-tandem-wheel load on a soil having a CBR of 1. The road will have to support several thousand truck passes and very little rutting will be allowed.

(1) Determine the required aggregate thickness with geotextile reinforcement.

(a) From figure 2-3 a 1 CBR is equal to a C value of 4.20.

(b) Choose a value of 5 for N_c since very little rutting will be allowed.

(c) Calculate CN_c as: $CN_c = 4.20(5) = 21$.

(d) Enter figure 2-6 with CN_c of 21 to obtain a value of 14 inches as the required aggregate thickness above the geotextile.

(e) Select geotextile requirements based on survivability requirements in tables 2-2 and 2-3.

(2) Determine the required aggregate thickness when a geotextile is not used.

(a) Use a value of 2.8 for N_c since a geotextile is not used and only a small amount of rutting will be allowed.

(b) Calculate CN_c as: $CN_c = 4.20(2.8) = 11.8$.

(c) Enter figure 2-6 with CN_c of 11.8 to obtain a value of 22 inches as the required aggregate thickness above the subgrade without the geotextile.

(3) Compare cost and benefits of the alternatives. Even with nearby economical gravel sources, the use of a geotextile usually is the more economical alternative for constructing low volume roads and airfields over soft cohesive soils. Additionally, it results in a faster time to completion once the geotextiles are delivered on site.

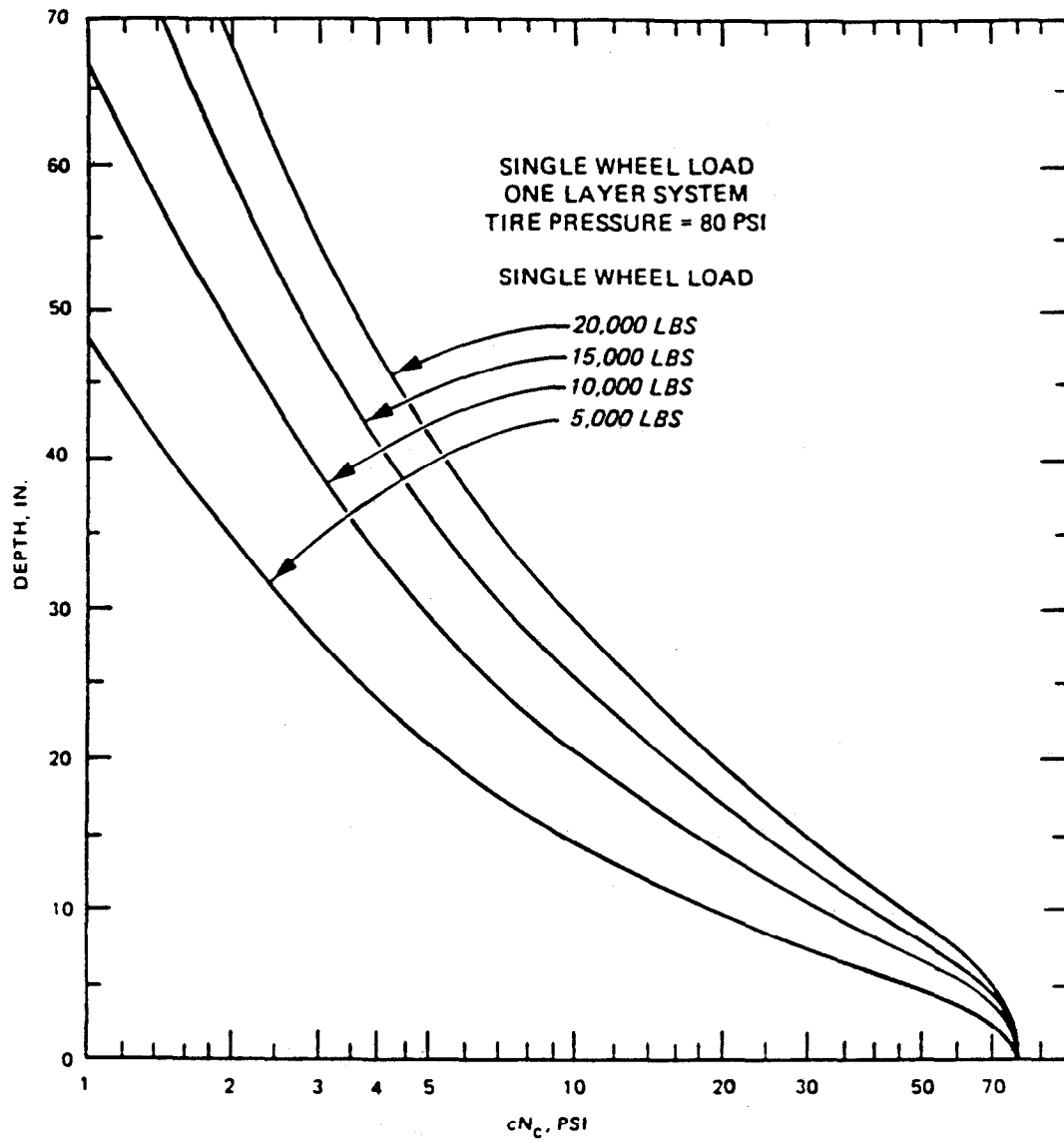

Figure 2-4. Thickness Design Curve for Single- Wheel Load on Gravel-Surfaced Roads.

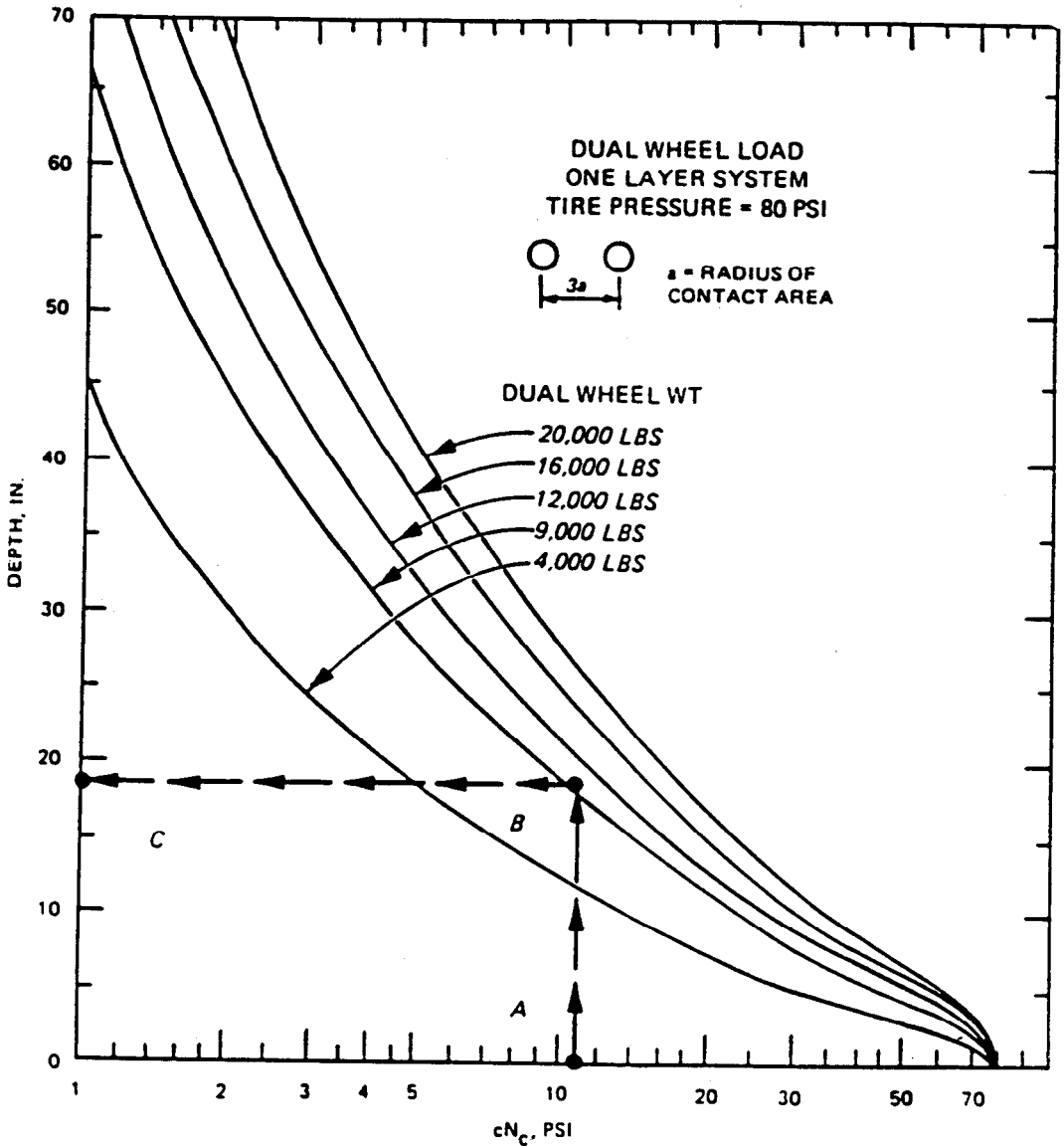

Figure 2-5. Thickness Design Curve for Dual-Wheel Load on Gravel-Surfaced Roads.

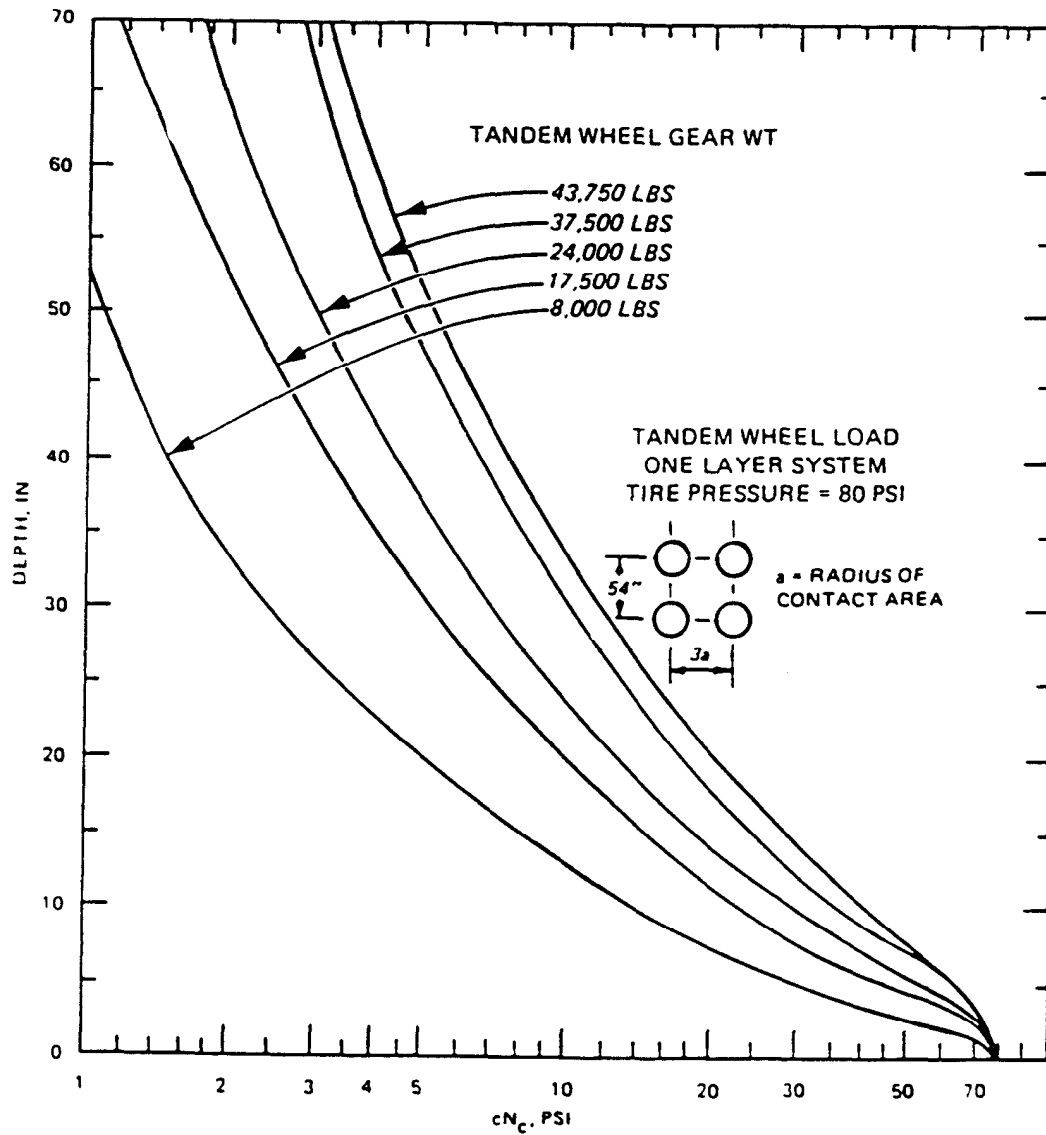

Figure 2-6. Thickness Design Curve for Tandem- Wheel Load on Gravel-Surfaced Roads.

CHAPTER 3

FILTRATION AND DRAINAGE

3-1 Water Control

Control of water is critical to the performance of buildings, pavements, embankments, retaining walls, and other structures. Drains are used to relieve hydrostatic pressure against underground and retaining walls, slabs, and underground tanks and to prevent loss of soil strength and stability in slopes, embankments, and beneath pavements. A properly functioning drain must retain the surrounding soil while readily accepting water from the soil and removing it from the area. These general requirements apply to granular and geotextile filters. While granular drains have a long performance history, geotextile use in drains is relatively recent and performance data are limited to approximately 25 years. Where not exposed to sunlight or abrasive contact with rocks moving in response to moving surface loads or wave action, long-term performance of properly selected geotextiles has been good. Since long-term experience is limited, geotextiles should not be used as a substitute for granular filters within or on the upstream face of earth dams or within any inaccessible portion of the dam embankment. Geotextiles have been used in toe drains of embankments where they are easily accessible if maintenance is required and where malfunction can be detected. Caution is advised in using geotextiles to wrap permanent piezometers and relief wells where they form part of the safety system of a water retaining structure. Geotextiles have been used to prevent infiltration of fine-grained materials into piezometer screens but long-term performance has not been measured.

3-2. Granular Drain Performance

To assure proper performance in granular drains, the designer requires drain materials to meet grain-size requirements based on grain size of the surrounding soil. The two principal granular filter criteria, piping and permeability, have been developed empirically through project experience and laboratory testing. The piping and permeability criteria are contained in TF 5-820-2/ AFJMAN 32-1016, Chap. 2.

3-3. Geotextile Characteristics Influencing Filter Functions

The primary geotextile characteristics influencing filter functions are opening size (as related to soil

retention), flow capacity, and clogging potential. These properties are indirectly measured by the apparent opening size (AOS) (ASTM D 4751), permittivity (ASTM D 4491), and gradient ratio test (ASTM D 5101). The geotextile must also have the strength and durability to survive construction and long-term conditions for the design life of the drain. Additionally, construction methods have a critical influence on geotextile drain performance.

3-4. Piping Resistance

a. *Basic Criteria.* Piping resistance is the ability of a geotextile to retain solid particles and is related to the sizes and complexity of the openings or pores in the geotextile. For both woven and nonwoven geotextiles, the critical parameter is the AOS. Table 3-1 gives the relation of AOS to the gradation of the soil passing the number 200 sieve for use in selecting geotextiles.

Table 3-1. Geotextile Filter Design Criteria.

Protected Soil (Percent Passing No. 200 Sieve)	Piping ¹	Permeability	
		Woven	Nonwoven ²
Less than 5%	AOS (mm) < 0.6 (mm) (Greater than #30 US Standard Sieve)	POA ³ > 10%	$k_G > 5k_S$
5 to 50%	AOS (mm) < 0.6 (mm) (Greater than #30 US Standard Sieve)	POA > 4%	$k_G > 5k_S$
50 to 85%	AOS (mm) < 0.297 (mm) (Greater than #50 US Standard Sieve)	POA > 4%	$k_G > 5k_S$
Greater than 85%	AOS (mm) < 0.297 (mm) (Greater than #50 US Standard Sieve)		$k_G > 5k_S$

¹ When the protected soil contains appreciable quantities of material retained on the No. 4 sieve use only the soil passing the No. 4 sieve in selecting the AOS of the geotextile.

² k_G is the permeability of the nonwoven geotextile and k_S is the permeability of the protected soil.

³ POA = Percent Open Area.

b. *Percent Open Area Determination Procedure for Woven Geotextiles.*

(1) Installation of geotextile. A small section of the geotextile to be tested should be installed in

a standard 2 by 2 inch slide cover, so that it can be put into a slide projector and projected onto a screen. Any method to hold the geotextile section and maintain it perpendicular to the projected light can be used.

(2) Slide projector. The slide projector should be placed level to eliminate any distortion of the geotextile openings. After placing the slide in the projector and focusing on a sheet of paper approximately 8 to 10 feet away, the opening outlines can be traced.

(3) Representative area. Draw a rectangle of about 0.5 to 1 square foot area on the "projection screen" sheet of paper to obtain a representative area to test; then trace the outline of all openings inside the designated rectangle.

(4) Finding the area. After removing the sheet, find the area of the rectangle, using a planimeter. If necessary, the given area may be divided to accommodate the planimeter.

(5) Total area of openings. Find the total area of openings inside rectangle, measuring the area of each with a planimeter.

(6) Compute percent. Compute POA by the equation:

$$POA = \frac{\text{Total Area Occupied by Openings}}{\text{Total Area of Test Rectangle}} \times 100$$

c. *Flow Reversals.* Piping criteria are based on granular drain criteria for preventing drain material from entering openings in drain pipes. If flow through the geotextile drain installation will be reversing and/or under high gradients (especially if reversals are very quick and involve large changes in head), tests, modeling prototype conditions, should be performed to determine geotextile requirements.

d. *Clogging.* There is limited evidence (Giroud 1982) that degree of uniformity and density of granular soils (in addition to the D_{85} size) influence the ability of geotextiles to retain the drained soil. For very uniform soils (uniformity coefficient 2 to 4), the maximum AOS may not be as critical as for more well graded soils (uniformity coefficient greater than 5). A gradient ratio test with observation of material passing the geotextile may be necessary to determine the adequacy of the material. In normal soil- geotextile filter systems, detrimental clogging only occurs when there is migration of fine soil particles through the soil matrix to the geotextile surface or into the geotextile. For most natural soils, minimal internal migration will take place. However, internal migration may take place under sufficient gradient if

one of the following conditions exists:

(1) The soil is very widely graded, having a coefficient of uniformity C_u greater than 20.

(2) The soil is gap graded. (Soils lacking a range of grain sizes within their maximum and minimum grain sizes are called "gap graded" or "skip graded" soils.) Should these conditions exist in combination with risk of extremely high repair costs if failure of the filtration system occurs the gradient ratio test may be required.

e. *Clogging Resistance.* Clogging is the reduction in permeability or permittivity of a geotextile due to blocking of the pores by either soil particles or biological or chemical deposits. Some clogging takes place with all geotextiles in contact with soil. Therefore, permeability test results can only be used as a guide for geotextile suitability. For woven geotextiles, if the POA is sufficiently large, the geotextiles will be resistant to clogging. The POA has proved to be a useful measure of clogging resistance for woven textiles but is limited to woven geotextiles having distinct, easily measured openings. For geotextiles which cannot be evaluated by POA, soil- geotextile permeameters have been developed for measuring soil-geotextile permeability and clogging. As a measure of the degree to which the presence of geotextile affects the permeability of the soil- geotextile system, the gradient ratio test can be used (ASTM D 5101). The gradient ratio is defined as the ratio of the hydraulic gradient across the geotextile and the 1 inch of soil immediately above the geotextile to the hydraulic gradient between 1 and 3 inches above the geotextile.

3-5. Permeability

a. *Transverse Permeability.* After installation, geotextiles used in filtration and drainage applications must have a flow capacity adequate to prevent significant hydrostatic pressure buildup in the soil being drained. This flow capacity must be maintained for the range of flow conditions for that particular installation. For soils, the indicator of flow capacity is the coefficient of permeability as expressed in Darcy's Law (TM 5-820-2/AFSMAN 32-1016). The proper application of Darcy's Law requires that geotextile thickness be considered. Since the ease of flow through a geotextile regardless of its thickness is the property of primary interest, Darcy's Law can be modified to define the term permittivity, Ψ , with units of sec^{-1} , as follows:

$$\Psi = \frac{k}{L_r} = \frac{q}{(\Delta h)A} \quad (\text{eq 3-1})$$

where

- k** = Darcy coefficient of permeability, L/T
- L_r** = length of flow path (geotextile thickness) over which Δh occurs, L
- q** = hydraulic discharge rate, L³/T
- Δh** = hydraulic head loss through the geotextile, L
- A** = total cross-sectional area available to flow, L²
- L** = units of length
- T** = units of time

The limitation of directly measuring the permeability and permittivity of geotextiles is that Darcy's Law applies only as long as laminar flow exists. This is very difficult to achieve for geotextiles since the hydraulic heads required to assure laminar flow are so small that they are difficult to accurately measure. Despite the fact that Darcy's equation does not apply for most measurements of permeability, the values obtained are considered useful as a relative measure of the permeabilities and permittivities of various geotextiles. Values of permeability reported in the literature, or obtained from testing laboratories, should not be used without first establishing the actual test conditions used to determine the permeability value. ASTM Method D 4491 should be used for establishing the permeability and permittivity of geotextiles. The permeability of some geotextiles decreases significantly when compressed by surrounding soil or rock. ASTM D 5493 can be used for measuring the permeabilities of geotextiles under load.

b. In-plane Permeability. Thick nonwoven geotextiles and special products as prefabricated drainage panels and strip drains have substantial fluid flow capacity in their plane. Flow capacity in a plane of a geotextile is best expressed independently of the material's thickness since the thickness of various materials may differ considerably, while the ability to transmit fluid under a given head and confining pressure is the property of interest. The property of in-plane flow capacity of a geotextile is termed "transmissivity," θ , and is expressed as:

$$\theta = k_{ot} = \frac{ql}{\theta hw} \quad (\text{eq 3-2})$$

where

- k_p** = in-plane coefficient of permeability (hydraulic conductivity), L/T
- t** = thickness of geotextile, L (ASTM D 5199)
- q** = hydraulic discharge rate, L³/T
- l** = length of geotextile through which liquid is flowing, L
- Δh** = hydraulic head loss, L
- w** = width of geotextile, L
- L** = units of length, length between geotextile grips
- T** = units of time

Certain testing conditions must be considered if meaningful values of transmissivity are to be acquired. These conditions include the hydraulic

gradients used, the normal pressure applied to the product being tested, the potential for reduction of transmissivity over time due to creep of the drainage material, and the possibility that intermittent flow will result in only partial saturation of the drainage material and reduced flow capacity. ASTM D 4716 may be used for evaluating the transmissivity of drainage materials.

c. Limiting Criteria. Permeability criteria for nonwoven geotextiles require that the permeability of the geotextile be at least five times the permeability of the surrounding soil. Permeability criteria for woven geotextiles are in terms of the POA. When the protected soil has less than 0.5 percent passing the No. 200 sieve, the POA should be equal to or greater than 10 percent. When the protected soil has more than 5 percent but less than 85 percent passing the No. 200 sieve, the POA should be equal to or greater than 4 percent.

3-6. Other Filter Considerations

a. To prevent clogging or blinding of the geotextile, intimate contact between the soil and geotextile should be assured during construction. Voids between the soil and geotextile can expose the geotextile to a slurry or muddy water mixture during seepage. This condition promotes erosion of soil behind the geotextile and clogging of the geotextile.

b. Very fine-grained noncohesive soils, such as rock flour, present a special problem, and design of drain installations in this type of soil should be based on tests with expected hydraulic conditions using the soil and candidate geotextiles.

c. As a general rule slit-film geotextiles are unacceptable for drainage applications. They may meet AOS criteria but generally have a very low POA or permeability. The wide filament in many slit films is prone to move relative to the cross filaments during handling and thus change AOS and POA.

d. The designer must consider that in certain areas an ochre formation may occur on the geotextile. Ochre is an iron deposit usually a red or tan gelatinous mass associated with bacterial slimes. It can, under certain conditions, form on and in subsurface drains. The designer may be able to determine the potential for ochre formation by reviewing local experience with highway, agricultural, embankment, or other drains with local or state agencies. If there is reasonable expectation for ochre formation, use of geotextiles is discouraged since geotextiles may be more prone to clog. Once ochre clogging occurs, removal from geotextiles is generally very difficult to impossible, since chemicals or acids used for ochre removal can-

damage geotextiles, and high pressure jetting through the perforated pipe is relatively ineffective on clogged geotextiles.

3-7. Strength Requirements

Unless geotextiles used in drainage applications have secondary functions (separation, reinforcement, etc.) requiring high strength, the requirements shown in table 3-2 will provide adequate strength.

Table 3-2. Geotextile Strength Requirements for Drains.

Strength Type	Test Method	Class A ¹	Class B ²
Grab Tensile	ASTM D 4632	180	80
Seam	ASTM D 4632	160	70
Puncture	ASTM D 4833	80	25
Burst	ASTM D 3786	290	130
Trapezoid Tear	ASTM D 4533	50	25

¹ Class A Drainage applications are for geotextile installation where applied stresses are more severe than Class B applications; i.e., very coarse shape angular aggregate is used, compaction is greater than 95 percent of ASTM D 1557 of maximum density or depth of trench is greater than 10 feet.

² Class B Drainage applications are for geotextile installations where applied stresses are less severe than Class A applications; i.e., smooth graded surfaces having no sharp angular projections, and no sharp angular aggregate, compaction is less than or equal to 95 percent of ASTM D 1557 maximum density.

3-8. Design and Construction Considerations

a. Installation Factors. In addition to the requirement for continuous, intimate geotextile contact with the soil, several other installation factors strongly influence geotextile drain performance. These include:

(1) How the geotextile is held in place during construction.

(2) Method of joining consecutive geotextile elements.

(3) Preventing geotextile contamination.

(4) Preventing geotextile deterioration from exposure to sunlight. Geotextile should retain 70 percent of its strength after 150 hours of exposure to ultraviolet sunlight (ASTM D 4355).

b. Placement. Pinning the geotextile with long nail-like pins placed through the geotextile into the soil has been a common method of securing the geotextile until the other components of the drain have been placed; however, in some applications, this method has created problems. Placement of aggregate on the pinned geotextile normally puts the geotextile into tension which increases potential for puncture and reduces contact of the geotextile with soil, particularly when placing the geotextile against vertical and/or irregular soil surfaces. It is much better to keep the geotextile loose but relatively unwrinkled during aggregate

placement. This can be done by using small amounts of aggregate to hold the geotextile in place or using loose pinning and repinning as necessary to keep the geotextile loose. This method of placement will typically require 10 to 15 percent more geotextile than predicted by measurement of the drain's planer surfaces.

c. Joints.

(1) Secure lapping or joining of consecutive pieces of geotextile prevents movement of soil into the drain. A variety of methods such as sewing, heat bonding, and overlapping are acceptable joints. Normally, where the geotextile joint will not be stressed after installation, a minimum 12-inch overlap is required with the overlapping inspected to ensure complete geotextile-to-geotextile contact. When movement of the geotextile sections is possible after placement, appropriate overlap distances or more secure joining methods should be specified. Field joints are much more difficult to control than those made at the factory or fabrication site and every effort should be made to minimize field joining.

(2) Seams are described in chapter 1. Strength requirements for seams may vary from just enough to hold the geotextile sections together for installation to that required for the geotextile. Additional guidance for seams is contained in AASHTO M 288. Seam strength is determined using ASTM 4632.

d. Trench Drains.

(1) Variations of the basic trench drain are the most common geotextile drain application. Typically, the geotextile lines the trench allowing use of a very permeable backfill which quickly removes water entering the drain. Trench drains intercept surface infiltration in pavements and seepage in slopes and embankments as well as lowering ground-water levels beneath pavements and other structures. The normal construction sequence is shown in figure 3-1. In addition to techniques shown in figure 3-1, if high compactive efforts are required (e.g., 95 percent of ASTM D 1557 maximum density), the puncture strength requirements should be doubled. Granular backfill does not have to meet piping criteria but should be highly permeable, large enough to prevent movement into the pipe, and meet durability and structural requirements of the project. This allows the designer to be much less stringent on backfill requirements than would be necessary for a totally granular trench drain. Some compaction of the backfill should always be applied.

(2) Wrapping of the perforated drain pipe with a geotextile when finer grained filter backfill is used is a less common practice. Normally not used

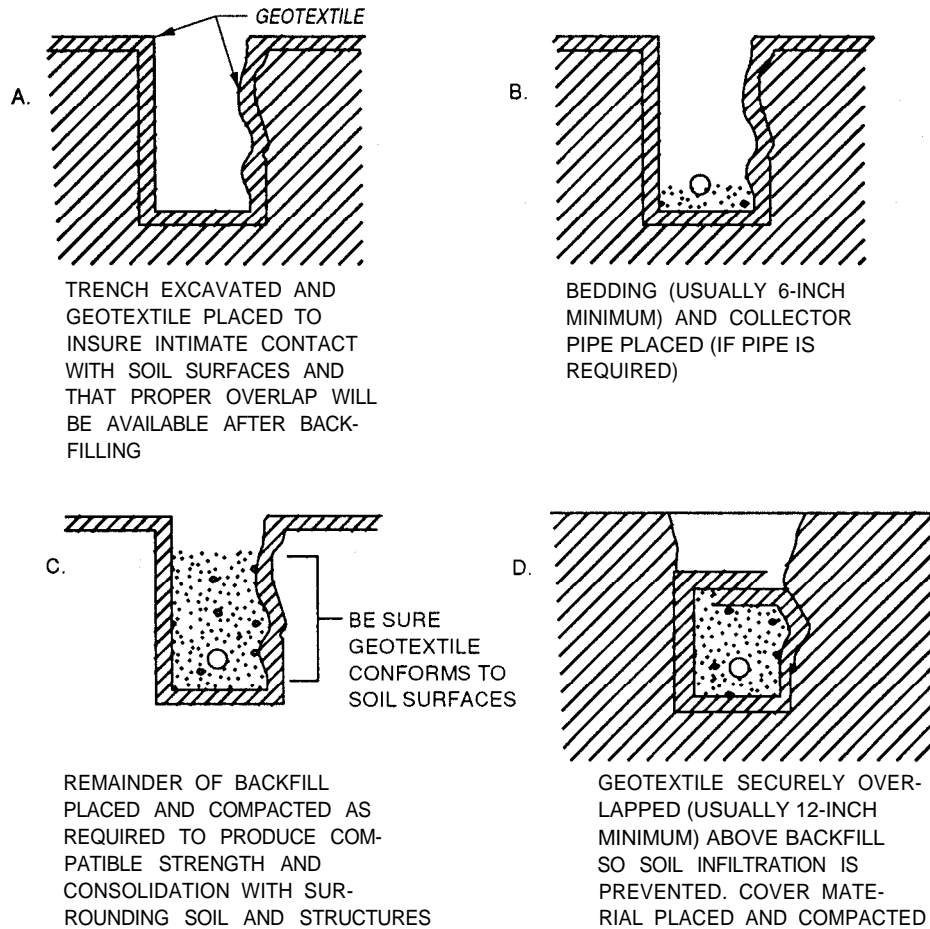

Figure 3-1. Trench Drain Construction.

in engineered applications, this method is less efficient than lining the trench with a geotextile because the reduced area of high permeability material concentrates flow and lowers drain efficiency. Wrapping of the pipe may be useful when finer grained filter materials are best suited because of availability and/or filter grain size requirements. In this case, the geotextile functions

as a cover for the pipe perforations preventing backfill infiltration. If the geotextile can be separated a small distance from the pipe surface, the flow through the geotextile into the pipe openings will be much more efficient. Use of plastic corrugated, perforated pipe with openings in the depressed portion of the corrugation is an easy way of doing this.

CHAPTER 4

GEOTEXTILE REINFORCED EMBANKMENT ON SOFT FOUNDATION

4-1. General

Quite often, conventional construction techniques will not allow dikes or levees to be constructed on very soft foundations because it may not be cost effective, operationally practical, or technically feasible. Nevertheless, geotextile-reinforced dikes have been designed and constructed by being made to float on very soft foundations. Geotextiles used in those dikes alleviated many soft-ground foundation dike construction problems because they permit better equipment mobility, allow expedient construction, and allow construction to design elevation without failure. This chapter will address the potential failure modes and requirements for design and selection of geotextiles for reinforced embankments.

4-2. Potential Embankment Failure Modes

The design and construction of geotextile-reinforced dikes on soft foundations are technically feasible, operationally practical, and cost effective when compared with conventional soft foundation construction methods and techniques. To successfully design a dike on a very soft foundation, three potential failure modes must be investigated (fig 4-1).

a. Horizontal sliding, and spreading of the embankment and foundation.

b. Rotational slope and/or foundation failure.

c. Excessive vertical foundation displacement.

The geotextile must resist the unbalanced forces necessary for dike stability and must develop moderate-to-high tensile forces at relatively low-to-moderate strains. It must exhibit enough soil-fabric resistance to prevent pullout. The geotextile tensile forces resist the unbalanced forces, and its tensile modulus controls the vertical and horizontal displacement of dike and foundation. Adequate development of soil-geotextile friction allows the transfer of dike load to the geotextile. Developing geotextile tensile stresses during construction at small material elongations or strains is essential.

d. Horizontal Sliding and Spreading. These types of failure of the dike and/or foundation may result from excessive lateral earth pressure (fig 4-1a). These forces are determined from the dike height, slopes, and fill material properties. During conventional construction the dikes would resist these modes of failure through shear forces developed along the dike-foundation interface. Where geotextiles are used between the soft foundation

and the dike, the geotextile will increase the resisting forces of the foundation. Geotextile-reinforced dikes may fail by fill material sliding off the geotextile surface, geotextile tensile failure, or excessive geotextile elongation. These failures can be prevented by specifying the geotextiles that meet the required tensile strength, tensile modulus, and soil-geotextile friction properties.

e. Rotational Slope and/or Foundation Failure. Geotextile-reinforced dikes constructed to a given height and side slope will resist classic rotational failure if the foundation and dike shear strengths plus the geotextile tensile strength are adequate (fig 4-1 b). The rotational failure mode of the dike can only occur through the foundation layer and geotextile. For cohesionless fill materials, the dike side slopes are less than the internal angle of friction. Since the geotextile does not have flexural strength, it must be placed such that the critical arc determined from a conventional slope stability analysis intercepts the horizontal layer. Dikes constructed on very soft foundations will require a high tensile strength geotextile to control the large unbalanced rotational moments.

f. Excessive Vertical Foundation Displacements. Consolidation settlements of dike foundations, whether geotextile-reinforced or not, will be similar. Consolidation of geotextile-reinforced dikes usually results in more uniform settlements than for non-reinforced dikes. Classic consolidation analysis is a well-known theory, and foundation consolidation analysis for geotextile-reinforced dikes seems to agree with predicted classical consolidation values. Soft foundations may fail partially or totally in bearing capacity before classic foundation consolidation can occur. One purpose of geotextile reinforcement is to hold the dike together until foundation consolidation and strength increase can occur. Generally, only two types of foundation bearing capacity failures may occur—partial or center-section foundation failure and rotational slope stability/foundation stability. Partial bearing failure, or “center sag” along the dike alignment (fig 4-1 c), may be caused by improper construction procedure, like working in the center of the dike before the geotextile edges are covered with fill materials to provide anchorage. If this procedure is used, geotextile tensile forces are not developed and no benefit is gained from the geotextile used. A foundation bearing capacity failure may occur as in conventional dike construction.

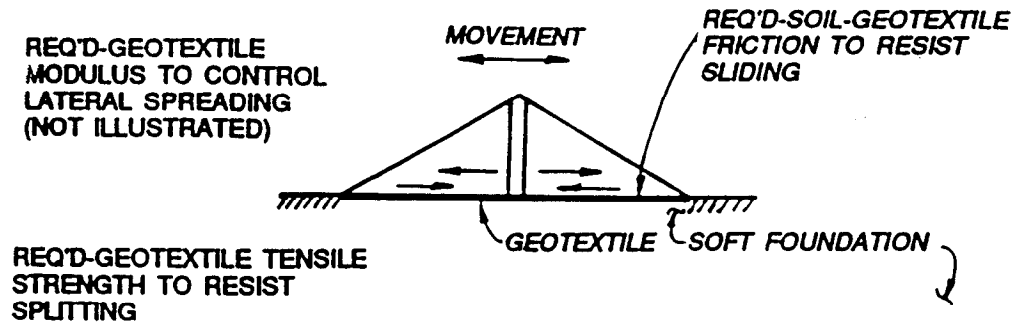

a. POTENTIAL EMBANKMENT FAILURE FROM LATERAL EARTH PRESSURE

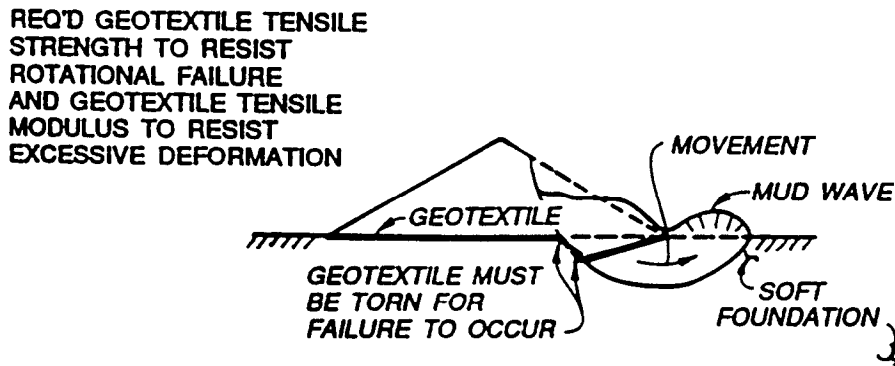

b. POTENTIAL EMBANKMENT ROTATIONAL SLOPE/FOUNDATION FAILURE

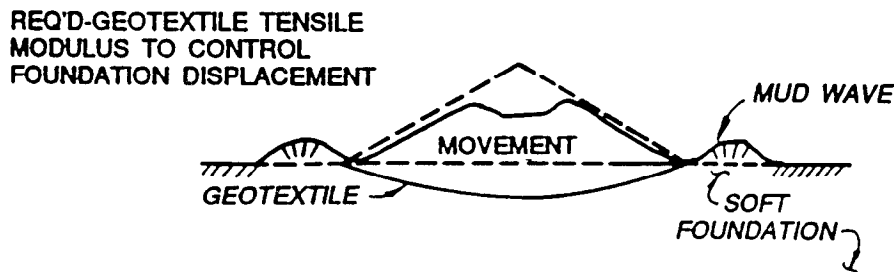

c. POTENTIAL EMBANKMENT FAILURE FROM EXCESSIVE DISPLACEMENT

Figure 4-1. Potential Geotextile-Reinforced Embankment Failure Modes.

Center sag failure may also occur when low-tensile strength or low-modulus geotextiles are used, and embankment spreading occurs before adequate geotextile stresses can be developed to carry the dike weight and reduce the stresses on the foundation. If the foundation capacity is exceeded, then the geotextile must elongate to develop the required geotextile stress to support the dike weight. Foundation bearing-capacity deformation will occur until either the geotextile fails in tension or carries the excess load. Low modulus geotextiles generally fail because of excessive foundation displacement that causes these low tensile strength geotextiles to elongate beyond their ultimate strength. High modulus geotextiles may also fail if their strength is insufficient. This type of failure may occur where very steep dikes are constructed, and where outside edge anchorage is insufficient.

4-3. Recommended Criteria

The limit equilibrium analysis is recommended for design of geotextile-reinforced embankments. These design procedures are quite similar to conventional bearing capacity or slope stability analysis. Even though the rotational stability analysis assumes that ultimate tensile strength will occur instantly to resist the active moment, some geotextile strain, and consequently embankment displacement, will be necessary to develop tensile stress in the geotextile. The amount of movement within the embankment may be limited by the use of high tensile modulus geotextiles that exhibit good soil-geotextile frictional properties. Conventional slope stability analysis assumes that the geotextile reinforcement acts as a horizontal force to increase the resisting moment. The following analytical procedures should be conducted for the design of a geotextile-reinforced embankment: (1) overall bearing capacity, (2) edge bearing capacity or slope stability, (3) sliding wedge analysis for embankment spreading/splitting, (4) analysis to limit geotextile deformation, and (5) determine geotextile strength in a direction transverse to the longitudinal axis of the embankment or the longitudinal direction of the geotextile. In addition, embankment settlements and creep must also be considered in the overall analysis.

a. Overall Bearing Capacity. The overall bearing capacity of an embankment must be determined whether or not geotextile reinforcement is used. If the overall stability of the embankment is not satisfied, then there is no point in reinforcing the embankment. Several bearing capacity procedures are given in standard foundation engineering textbooks. Bearing capacity analyses follow classical limiting equilibrium analysis for strip footings,

using assumed logarithmic spiral or circular failure surfaces. Another bearing capacity failure is the possibility of lateral squeeze (plastic flow) of the underlying soils. Therefore, the lateral stress and corresponding shear forces developed under the embankment should be compared with the sum of the resisting passive forces and the product of the shear strength of the soil failure plane area. If the overall bearing capacity analysis indicates an unsafe condition, stability can be improved by adding berms or by extending the base of the embankment to provide a wide mat, thus spreading the load to a greater area. These berms or mats may be reinforced by properly designing geotextiles to maintain continuity within the embankment to reduce the risk of lateral spreading. Wick drains may be used in case of low bearing capacity to consolidate the soil rapidly and achieve the desired strength. The construction time may be expedited by using geotextile reinforcement.

b. Slope Stability Analysis. If the overall bearing capacity of the embankment is determined to be satisfactory, then the rotational failure potential should be evaluated with conventional limit equilibrium slope stability analysis or wedge analysis. The potential failure mode for a circular arc analysis is shown in figure 4-2. The circular arc method simply adds the strength of the geotextile layers to the resistance forces opposing rotational sliding because the geotextile must be physically torn for the embankment to slide. This analysis consists of determining the most critical failure surfaces, then adding one or more layers of geotextile at the base of the embankment with sufficient strength at acceptable strain levels to provide the necessary resistance to prevent failure at an acceptable factor of safety. Depending on the nature of the problem, a wedge-type slope stability analysis may be more appropriate. The analysis may be conducted by accepted wedge stability methods, where the geotextile is assumed to provide horizontal resistance to outward wedge sliding and solving for the tensile strength necessary to give the desired factor of safety. The critical slip circle or potential failure surfaces can be determined by conventional geotechnical limited equilibrium analysis methods. These methods may be simplified by the following assumptions:

(1) Soil shear strength and geotextile tensile strength are mobilized simultaneously.

(2) Because of possible tensile crack formations in a cohesionless embankment along the critical slip surface, any shear strength developed by the embankment (above the geotextile) should be neglected.

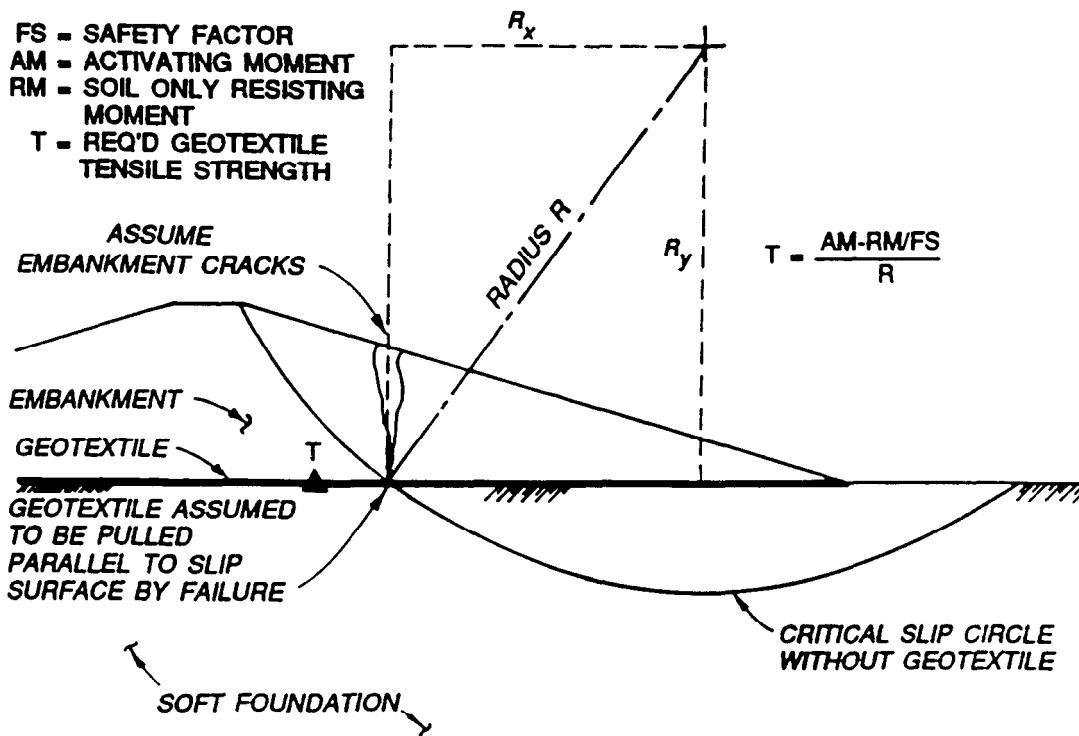

Figure 4-2. Concept Used for Determining Geotextile Tensile Strength Necessary to Prevent Slope Failure.

(3) The conventional assumption is that critical slip circles will be the same for both the geotextile-reinforced and nonreinforced embankments although theoretically they may be different. Under these conditions, a stability analysis is performed for the no-geotextile condition, and a critical slip circle and minimum factor of safety is obtained. A driving moment or active moment (AM) and soil resistance moment (RM) are determined for each of the critical circles. If the factor of safety (FS) without geotextile is inadequate, then an additional reinforcement resistance moment can be computed from the following equation:

$$TR + RM/FS = AM \quad (\text{eq 4-1})$$

where

- T = geotextile tensile strength
- R = radius of critical slip circle
- RM = soil resistance moment
- FS = factor of safety
- AM = driving or active moment

This equation can be solved for T so that the geotextile reinforcement can also be determined to provide the necessary resisting moment and required FS.

c. *Sliding Wedge Analysis.* The forces involved in an analysis for embankment sliding are shown

in figure 4-3. These forces consist of an actuating force composed of lateral earth pressure and a resisting force created by frictional resistance between the embankment fill and geotextile. To provide the adequate resistance to sliding failure, the embankment side slopes may have to be adjusted, and a proper value of soil-geotextile friction needs to be selected. Lateral earth pressures are maximum beneath the embankment crest. The resultant of the active earth pressure per unit length (P_A) for the given cross section may be calculated as follows:

$$P_A = 0.5 \gamma_m H^2 K_A \quad (\text{eq 4-2})$$

where

- γ_m = embankment fill compacted density-force per length cubed
- H = maximum embankment height
- K_A = coefficient of active earth pressure (dimensionless)

For a cohesionless embankment fill, the equation becomes:

$$P_A = 0.5 \gamma_m H^2 \tan^2 \left(45 - \frac{\phi}{2} \right) \quad (\text{eq 4-3})$$

Resistance to sliding may be calculated per unit length of embankment as follows:

$$P_R = 0.5 \gamma_m XH^2 \tan \phi_{SG} \quad (\text{eq 4-4})$$

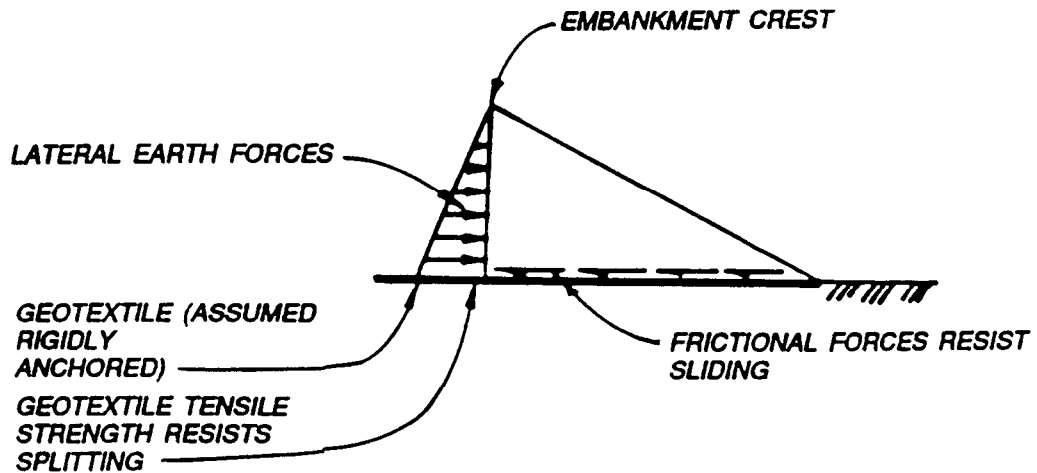

a. FORCES INVOLVED IN SPLITTING AND SLIDING ANALYSES

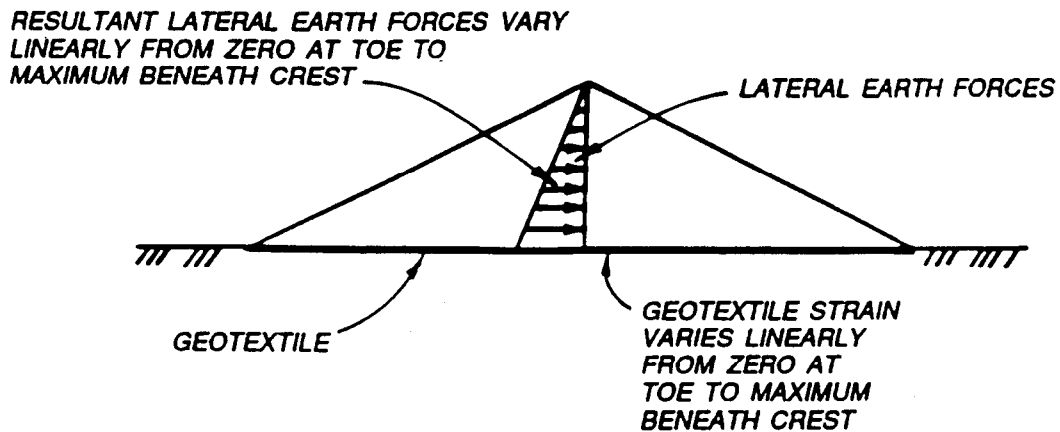

NOTE: FABRIC MODULES CONTROLS LATERAL SPREADING

b. GEOTEXTILE STRAIN CHARACTERISTICS RELATING TO EMBANKMENT SPREADING ANALYSIS

Figure 4-3. Assumed Stresses and Strains Related to Lateral Earth Pressures.

where

PR = resultant of resisting forces

X = dimensionless slope parameter (i.e., for 3H on 1V slope, X = 3 or an average slope may be used for different embankment configurations)

ϕ_{SG} = soil-geotextile friction angle (degrees)

A factor of safety against embankment sliding failure may be determined by taking the ratio of the resisting forces to the actuating forces. For a

given embankment geometry the FS is controlled by the soil-geotextile friction. A minimum FS of 1.5 is recommended against sliding failure. By combining the previous equations with a factor of 2, and solving for ϕ_{SG} , the soil geotextile friction angle gives the following equation:

$$\phi_{SG} = \tan^{-1} \frac{FS}{X} \tan^2 \left(45^\circ - \frac{\phi}{2} \right) \quad (\text{eq 4-5})$$

If it is determined that the required soil-geotextile friction angle exceeds what might be achieved

with the soil and geotextile chosen, then the embankment side slopes must be flattened, or additional berms may be considered. Most high-strength geotextiles exhibit a fairly high soil-geotextile friction angle that is equal to or greater than 30 degrees, where loose sand-size fill material is utilized. Assuming that the embankment sliding analysis results in the selection of a geotextile that prevents embankment fill material from sliding along the geotextile interface, then the resultant force because of lateral earth pressure must be less than the tensile strength at the working load of the geotextile reinforcement to prevent spreading or tearing. For an FS of 1, the tensile strength would be equal to the resultant of the active earth pressure per unit length of embankment. A minimum FS of 1.5 should be used for the geotextile to prevent embankment sliding. Therefore, the minimum required tensile strength to prevent sliding is:

$$T_G = 1.5 P_A \quad (\text{eq 4-6})$$

where T_G = minimum geotextile tensile strength.

d. Embankment Spreading Failure Analysis. Geotextile tensile forces necessary to prevent lateral spreading failure are not developed without some geotextile strain in the lateral direction of the embankment. Consequently, some lateral movement of the embankment must be expected. Figure 4-3 shows the geotextile strain distribution that will occur from incipient embankment spreading if it is assumed that strain in the embankment varies linearly from zero at the embankment toe to a maximum value beneath embankment crest. Therefore, an FS of 1.5 is recommended in determining the minimum required geotextile tensile modulus. If the geotextile tensile strength (T_G) determined by equation 4-6 is used to determine the required tensile modulus (E_G), an FS of 1.5 will be automatically taken into account, and the minimum required geotextile tensile modulus may be calculated as follows:

$$E_G = \frac{T_g}{\epsilon_{\max}} \quad (\text{eq 4-7})$$

where ϵ_{\max} = maximum strain which the geotextile is permitted to undergo at the embankment center line. The maximum geotextile strain is equal to twice the average strain over the embankment width. A reasonable average strain value of 2.5 percent for lateral spreading is satisfactory from a construction and geotextile property standpoint. This value should be used in design but depending on the specific project requirements larger strains may be specified. Using 2.5 percent

as the average strain, then the maximum strain which would occur is 5 percent.

e. Potential Embankment Rotational Displacement. It is assumed that the geotextile ultimate tensile resistance is instantaneously developed to prevent rotational slope/foundation failure and is inherently included in the slope stability limit equilibrium analysis. But for the geotextile to develop tensile resistance, the geotextile must strain in the vicinity of the potential failure plane. To prevent excessive rotational displacement, a high-tensile-modulus geotextile should be used. The minimum required geotextile tensile modulus to limit or control incipient rotational displacement is the same as for preventing spreading failure.

f. Longitudinal Geotextile Strength Requirements. Geotextile strength requirements must be evaluated and specified for both the transverse and longitudinal direction of the embankment. Stresses in the warp direction of the geotextile or longitudinal direction of the embankment result from foundation movement where soils are very soft and create wave or a mud flow that drags on the underside of the geotextile. The mud wave not only drags the geotextile in a longitudinal direction but also in a lateral direction toward the embankment toes. By knowing the shear strength of the mud wave and the length along which it drags against the underneath portion of the geotextile, then the spreading force induced can be calculated. Forces induced during construction in the longitudinal direction of the embankment may result from the lateral earth pressure of the fill being placed. These loads can be determined by the methods described earlier where $T_G = 1.5 P_A$, and $E_G \approx 20 T_G$ at 5 percent strain. The geotextile strength required to support the height of the embankment in the direction of construction must also be evaluated. The maximum load during construction includes the height or thickness of the working table, the maximum height of soil and the equipment live and dead loads. The geotextile strength requirements for these construction loads must be evaluated using the survivability criteria discussed previously.

g. Embankment Deformation. One of the primary purposes of geotextile reinforcement in an embankment is to reduce the vertical and horizontal deformations. The effect of this reinforcement on horizontal movement in the embankment spreading modes has been addressed previously. One of the more difficult tasks is to estimate the deformation or subsidence caused by consolidation and by plastic flow or creep of very soft foundation materials. Elastic deformations are a function of

the subgrade modulus. The presence of a geotextile increases the overall modulus of the reinforced embankment. Since the lateral movement is minimized by the geotextile, the applied loads to the soft foundation materials are similar to the applied loads in a laboratory consolidation test. Therefore, for long-term consolidation settlements beneath geotextile-reinforced embankments, the compressibility characteristics of the foundation soils should not be altered by the presence of the reinforcement. A slight reduction in total settlement may occur for a reinforced embankment but no significant improvement. Other studies indicate that very high-strength, high-tensile modulus geotextiles can control foundation displacement during construction, but the methods of analysis are not as well established as those for stability analysis. Therefore, if the embankment is designed for stability as outlined previously, then the lateral and vertical movements caused by subsidence

from consolidation settlements, plastic creep, and flow of the soft foundation materials will be minimized. It is recommended that a conventional consolidation analysis be performed to determine foundation settlements.

4-4. Example Geotextile-Reinforced Embankment Design

a. The Assumption.

(1) An embankment, fill material consisting of clean sand with $\gamma_m = 100$ pounds per cubic foot, and $f = 30$ degrees (where f is the angle of internal friction).

(2) Foundation properties (unconsolidated, undetermined shear strength) as shown in figure 4-4 (water table at surface).

(3) Embankment dimensions (fig 4-4).

(a) Crest width of 12 feet.

(b) Embankment height (H) of 7 feet.

(c) Embankment slope, 10 Horizontal on 1 Vertical (i.e., $x = 10$).

NOTE: NATURAL GROUND SURFACE COVERED WITH GRASS AND VOID OF OTHER THAN SMALL DEBRIS, HUMPS, DEPRESSIONS, ETC. MAY OR MAY NOT HAVE A CRUST

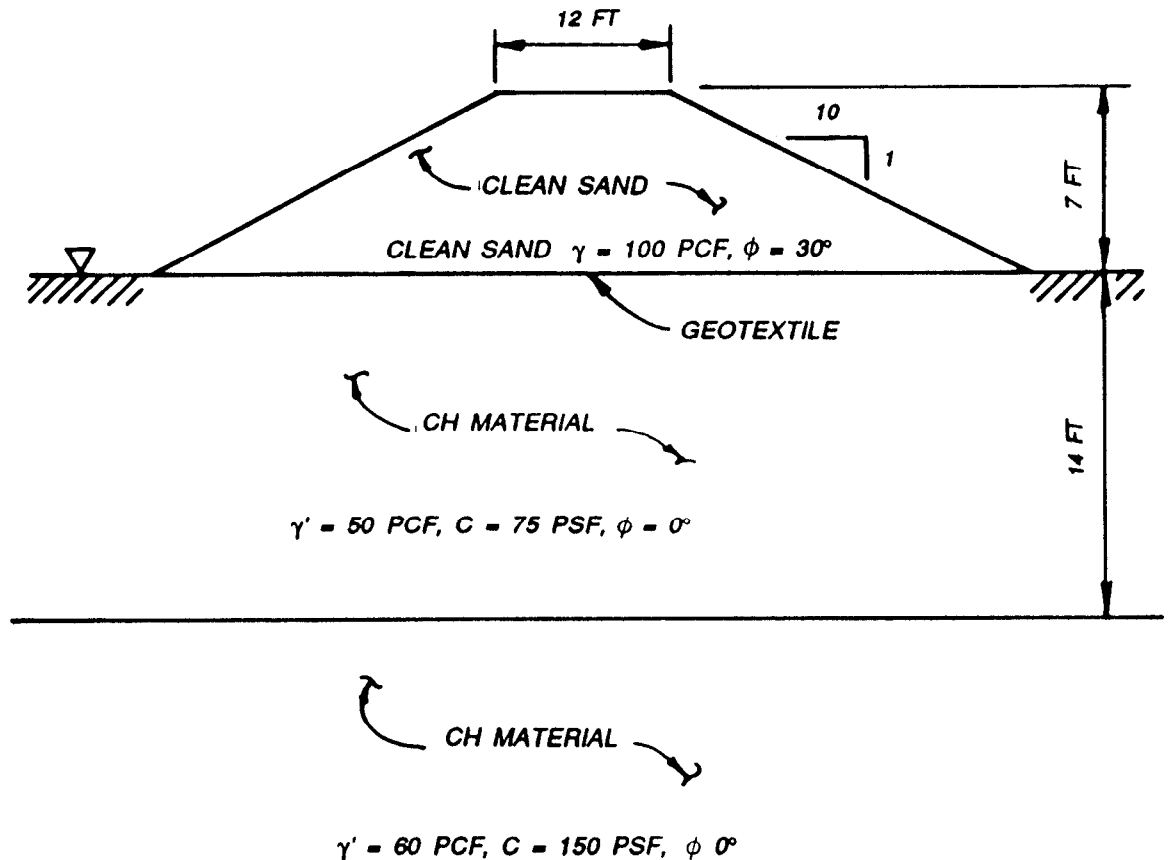

Figure 4-4. Embankment Section and Foundation Conditions of Embankment Design Example Problem.

b. *Factor of Safety.* This design example will consider an FS of 1.3 against rotational slope failure, 1.5 against spreading, 2.0 against sliding failure, and 1.3 against excessive rotational displacement for the geotextile fabric requirements. Determine minimum geotextile requirements.

c. *Calculate Overall Bearing Capacity.*

(1) Ultimate bearing capacity qult for strip footing on clay.

$$q_{ult} = cN_c = (75)(5.14) = 385 \text{ pounds per square foot (with surface crust)}$$

$$q_{ult} = cN_c = (75)(3.5) = 263 \text{ pounds per square foot (without surface crust)}$$

Values shown for N_c are standard values for $\phi = 0$. It has been found from experience that excessive mud wave formation is minimized when a dried crust has formed on the ground surface.

(2) *Applied stress.*

$$\sigma_v = \gamma_m H = 100(7) = 700 \text{ pounds per square foot}$$

(3) *Determine FS.* The bearing capacity was not sufficient for an unreinforced embankment, but for a geotextile-reinforced embankment, the lower portion of its base will act like a mat foundation, thus distributing the load uniformly over the entire embankment width. Then, the average vertical applied stress is:

$$q_a = \frac{2 \left(\sigma_v \times \frac{L}{2} \right) + \text{crest width} \times \sigma_v}{2 \times \text{dike slope width} + \text{Crest width}}$$

$$q_a = \frac{2 \left(700 \times \frac{70}{2} \right) + 12 (700)}{2 \times 70 + 12}$$

$$q_a = 378$$

$$FS = \frac{q_{ult}}{q_a} = \frac{385}{378} < 1.0$$

where L = width of embankment slope. If a dried crust is available on the soft foundation surface, then the FS is about 1. If no surface crust is available, the FS is less than 1.0, and the embankment slopes or crest height would have to be modified. Since the embankment is very wide and the soft clay layer is located at a shallow depth, failure is not likely because the bearing-capacity analysis assumes a uniform soil twice the depth of the embankment width.

4-5. Bearing-Capacity Consideration

A second bearing-capacity consideration is the chance of soft foundation material squeezing out. Therefore, the lateral stress and corresponding shear forces below the embankment, with respect to resisting passive forces and shear strength of soil, are determined.

a. Plastic flow method for overall squeeze-squeeze between two plates.

$$c_{req/d} = \frac{\sigma_v \times a}{2L + \text{crest width}} \tag{eq 4-8}$$

where

- c = cohesion (shear strength) of soil
- a = 1/2 distance between embankment and next higher strength foundation soil layer
- L = width of embankment slope

For the conditions in previous example:

$$c_{req/d} = \frac{(700) \left(\frac{14}{2} \right)}{140 + 12}$$

$$c_{req/d} = 32.2$$

Cohesion available is 75 pounds per square foot, which is greater than 32.2 pounds per square foot required and is therefore satisfactory.

b. Toe squeeze of soft foundation materials is a common problem that requires investigating. Therefore, the passive resistance for toe squeeze is as follows:

$$P_a \text{ (just below embankment)} = \gamma_m H - 2c + q_a \tag{eq 4-9}$$

$$P_p \text{ (resisting squeeze)} = \gamma_m H + 2c \tag{eq 4-10}$$

Then, the difference:

$$P_p - P_a = \gamma_m H + 2c - (\gamma_m H - 2c + q_a) \tag{eq 4-11}$$

$$P_p - P_a = 4c - q_a \tag{eq 4-12}$$

For the example:

$$P_p - P_a = 4(75) - 378$$

$$P_p - P_a = 300 - 378$$

$$P_a - P_p = 78$$

P_a is greater than P_p therefore, foundation squeeze may occur. Solutions would be to either allow squeezing to occur or construct shallow berms to stabilize the embankment toe or use plastic strip drains.

c. *Slope Stability Analysis.* Perform a slope stability analysis to determine the required geotextile tensile strength and modulus to provide an FS of

1.3 against rotational slope failure. There are many slope stability procedures available in the literature for determining the required tensile strength T. Computer programs are also available that will determine the critical slip surface with a search routine. Assume that an analysis was conducted on the example embankment and an active moment of 840,000 foot-pounds per foot of width was calculated and a resisting moment of 820,000 foot-pounds per foot of width calculated for a slip circle having a radius of 75 feet. This would result in a safety factor of 0.98 which is not satisfactory. Using equation 4-1, the tensile strength of a geotextile necessary to provide an FS of 1.3 can be calculated as follows:

$$T = \frac{AM - RM}{FS \cdot R}$$

$$T = \frac{840,000 - 820,000}{1.3 \cdot 75} = 2,800 \text{ pounds per foot of width}$$

d. *Pullout Resistance.* Pullout resistance of the geotextile from the intersection of the potential failure plane surface is determined by calculating the resistance and necessary geotextile embedment length. There are two components to geotextile pullout resistance—one below and one above the geotextile. Resistance below the geotextile in this example is 50 pounds per square foot, and resistance above the geotextile is determined by the average height of fill above the geotextile in the affected areas. In this example, the resistance above and below the geotextile is determined as follows:

$$R_p = \gamma_m h \tan \phi_1 + C_r \quad (\text{eq 4-13})$$

where

- γ_m = moist weight of sand fill, 100 pounds per cubic foot
- h = average height of sand fill above geotextile in the affected area, 6.5 feet
- ϕ_1 = sand-geotextile friction equal to $(\frac{2}{3})\phi$
- C_r = remolded strength of foundation clay soil beneath the geotextile, 50 pounds per square foot

$$R_p = (100)(6.5) \tan [(\frac{2}{3}) 30^\circ] + 50$$

$$R_p = 287 \text{ width}$$

The required pullout length is determined from the ultimate tensile strength requirement of 2,800 pounds per foot width. Therefore,

$$L = T/R_p = \frac{2,800}{287}$$

$$L = 9.8 \text{ ft; approximately 10 ft}$$

e. *Prevention of Sliding.* Calculate ϕ_{SG} to provide an FS of 2 against sliding failure across the geotextile.

(1) Calculate lateral earth pressure, P_A ;

$$P_A = (0.5) \gamma_m H^2 \tan^2 \left(45^\circ - \frac{\phi}{2} \right)$$

$$P_A = 0.5 (100) (7)^2 \tan^2 \left(45 - \frac{30^\circ}{2} \right)$$

$$P_A = 817$$

(2) Calculate ϕ_{SG} :

$$FS = \frac{\text{Resisting Force}}{\text{Active Force}}$$

$$FS = \frac{0.5 \gamma_m X H^2 \tan \phi_{SG}}{0.5 \gamma_m H^2 \tan^2 \left(45 - \frac{\phi}{2} \right)}$$

$$\tan \phi_{SG} = \left(\frac{FS}{X} \right) \tan^2 \left(45 - \frac{\phi}{2} \right)$$

where X = ratio of the vertical and horizontal slope (i.e., 10 horizontal to 1 vertical).

$$\tan \phi_{SG} = \left(\frac{2.0}{10} \right) \tan^2 \left(45^\circ - \frac{30^\circ}{2} \right)$$

$$\tan \phi_{SG} = (0.2) \tan^2 30^\circ = (0.2)(0.58)^2$$

$$\phi_{SG} = \tan^{-1} (0.07)$$

$$\phi_{SG} = 3.9^\circ$$

f. *Prevention of Geotextile Splitting.* Calculate required geotextile tensile strength (T_G) to provide an FS of 1.5 against splitting.

$$FS = 1.5 \text{ against splitting}$$

$$P_A = 817 \text{ pounds per foot width}$$

Calculate T_G :

$$T_G = 1.5 P_A$$

$$T_G = (1.5)(817)$$

$$T_G = 1,226 \text{ pounds per foot width or}$$

$$T_G = 102 \text{ pounds per inch width}$$

g. *Limiting Spreading and Rotation.* Calculate the tensile modulus E_G required to limit embankment average spreading and rotation to 5 percent geotextile elongation.

(1) Spreading analysis:

$$E_G = 20 T_G$$

$$E_G = (20)(102)$$

$$E_G = 2,040 \text{ pounds per inch width}$$

(2) Rotational slope stability analysis:

$$E_{GR} = 20 T$$

$$E_{GR} = (20)(T = 233 \text{ pounds per inch width})$$

$$E_{GR} = 4,670 \text{ pounds per inch width}$$

h. Tensile Seam Strength and Fill Requirements. Determine geotextile tensile strength requirements in geotextile till (cross machine direction) and across seams. Tensile strength requirement in this direction depends on the amount of squeezing out and dragging loads on the underside of the geotextile and the amount of shoving or sliding that the 2 to 3 feet of sand fill material causes during initial placement. If three panels 16 feet wide are in place and the foundation material moves longitudinally along the embankment alignment because of construction activities when establishing a working platform, then the loads in the geotextile fill direction can be calculated as follows:

(1) Geotextile fill and seam tensile strength requirement:

$$T_{GRF} = (3 \text{ panels}) (16 \text{ feet wide}) C_r$$

where

$$T_{GRF} = (3)(16 \text{ feet}) (50 \text{ pounds per square foot.})$$

$$T_{GRF} = 2,400 \text{ pounds per foot width}$$

$$T_{GRF} = 200 \text{ pounds per inch width}$$

$$T_{GRF} \text{ at FS of 1.5} = 300 \text{ pounds per inch width}$$

C_r = remolded shear strength of foundation materials

(2) Geotextile fill and seam tensile modulus of 10 percent elongation:

$$E_{GRF} = 10 T_{GRF}$$

$$E_{GRF} = 3,000 \text{ pounds per inch width}$$

i. Summary of Minimum Geotextile Requirements. If the geotextile chosen is a woven polyester yarn and only 50 percent of the ultimate geotextile load is used, then the minimum ultimate strength is 2 times the required working tensile strength 233, or 466 pounds per inch width to compensate for possible creep.

(1) Soil-geotextile friction angle, ϕ_{SG} equals 3.9 degrees.

(2) Ultimate tensile strength T_{ULT} in the geotextile warp directions working tensile strength equals 466 pounds per inch width.

(3) Ultimate tensile strength T_{GRF} in the geotextile fill and cross seams directions equals to 300 pounds per inch width.

(4) Tensile modulus (slope of line drawn through zero load and strain and trough load at 5 percent elongation) at 5 percent geotextile elongation in geotextile warp direction is 4,670 pounds per inch width, (based on working tensile strength) and 10 percent geotextile elongation in the fill and cross seam directions is 3,000 pounds per inch width.

(5) Contractor survivability and constructability requirements are included in tables 2-3, 2-4 and 2-5. Geotextile specifications must meet or exceed these requirements.

CHAPTER 5

RAILROAD TRACK CONSTRUCTION AND REHABILITATION

5-1. General

The use of geotextiles in a railroad track structure is dependent upon many factors including the traffic, track structure, subgrade conditions, drainage conditions, and maintenance requirements. In railroad applications, geotextiles are primarily used to perform the functions of separation, filtration, and lateral drainage. Based on current knowledge, little is known of any reinforcement effect geotextiles have on soft subgrades under railroad track. Therefore, geotextiles should not be used to reduce the ballast or subballast design thickness. Geotextiles have found their greatest railroad use in those areas where a large amount of track maintenance has been required on an existing right-of-way as a result of poor drainage conditions, soft conditions, and/or high-impact loadings. Geotextiles are normally placed between the subgrade and ballast layer or between the subgrade and subballast layers if one is present. A common geotextile application is found in what is commonly known as "pumping track" and "ballast pocket areas." Both are associated with fine-grained subgrade soil and difficult drainage conditions. Under traffic, transient vertical stresses are sufficient to cause the subgrade and ballast or subballast materials to intermix if the subgrade is weak (i.e. wet). As the intermixing continues, the ballast becomes fouled by excessive fines contamination, and a loss of free drainage through the ballast occurs as well as a loss of shear strength. The ballast is pulled down into the subgrade. As this process continues, ballast is forced deeper and deeper into the subgrade, forming a pocket of fouled and ineffective ballast and loss of track grade control. Ballast pockets tend to collect water, further reducing the strength of the roadbed around them and result in continual track maintenance problems. Installation of geotextiles during rehabilitation of these areas provides separation, filtration, and drainage functions and can prevent the reoccurrence of pumping track. Common locations for the installation of a geotextile in railroad track are locations of excessive track maintenance resulting from poor subgrade/drainage conditions, highway-railroad grade crossing, diamonds (railroad crossings), turnouts, and bridge approaches. If a geotextile is installed in track without provisions made for adequate drainage, water will be retained in the track structure and the instability of

the track will be worsened. In any track construction or rehabilitation project, adequate drainage must be incorporated in the project design.

5-2. Material Selection

a. Based on current knowledge, woven geotextiles are not recommended for use in railroad track applications. Test installations have shown that woven geotextiles tend to clog with time and act almost as a plastic sheet preventing water from draining out of the subgrade.

b. Geotextiles selected for use in the track structure of military railroads should be nonwoven, needle-punched materials that meet the requirements listed in table 5-1.

c. ASTM D 4886 is used to measure the abrasion resistance of a geotextile for use in a railroad application. Indications are that abrasion is greater for geotextiles placed during track rehabilitations where the rail remains in-place than for geotextiles placed during new construction or rehabilitations where the existing rail, ties, and ballast are removed and the subgrade reworked. This may be due to the differences in the surface upon which the geotextile is placed. In new construction the subgrade surface is normally graded, compacted and free from large stone. During in-place rehabilitations the old ballast may be removed by undercutting or ploughing which leave ballast particles loose on, or protruding from, the surface, creating a rough surface for placement of the geotextile.

5-3. Application

Geotextiles should be used to separate the ballast or subballast from the subgrade (or ballast from subballast) in a railroad track in cut sections where the subgrade soil contains more than 25 percent by weight of particles passing the No. 200 sieve. Geotextiles are also used in embankment sections consisting of such material where there is less than 4 feet from the bottom of the tie to the ditch invert or original ground surface.

5-4. Depth of Placement

Technical Manual TM 5-850-2/AFM 88-7, chap. 2 specifies a minimum ballast thickness of 12 inches. An additional minimum of 6 inches of subballast may be used in areas where drainage is difficult. The actual total ballast/ subballast thickness required is a function of the maximum wheel load, rail weight, size, tie spacing, and allowable

Property (1)	Minimum Requirement ¹ (2)	Test Method (3)
Weight', ounce per square yard	15	ASTM D 3776 option B
Structure	Needle-punched nonwoven	--
Grab tensile strength, pounds	350	ASTM D 4632
Elongation at failure, percent	20	ASTM D 4632
Burst strength, pounds per square inch	620	ASTM D 3786
Puncture strength, pounds	185	ASTM D 4833
Trapezoidal tear strength, pounds	150	ASTM D 4533
Apparent opening size (AOS), millimeter	<0.22 (No. 70 sieve)	ASTM D 4751
Normal permeability, (k) ³ , centimeters per second	0.1	ASTM D 4491
Permittivity, seconds ⁻¹	0.2	ASTM D 4491
Planar water flow/transmissivity ⁴ square feet per minute X 10 ⁻³	6	ASTM D 4716
Ultraviolet degradation at 150 hours percent strength retained	70	ASTM D 4355
Seam strength, pounds ⁵	350	ASTM D 1683

¹Value in weaker principal direction. All numerical values represent minimum average roll value.

²The minimum weight listed herein is based on the experience that geotextiles with weights less than 15 oz/yd tend to show greater abrasion and wear than do heavier weight materials. It is recommended that the selection of geotextile be based on the minimum physical property requirements of this table and not solely on weight.

³The k of the geotextile should be at least five times greater than the k value of the soil.

⁴Planar water flow/transmissivity determined at normal stress of 3.5 psi and $i = 1.0$.

⁵Seam strength applies to both field and manufactured seams, if geotextile is seamed.

Table 5-1. Recommended Geotextile Property Requirements for Railroad Applications.

subgrade bearing pressure. In the design of new track construction or track rehabilitation using geotextiles, the geotextile should be placed at the deeper of the following:

- a. At least 12 inches below the cross tie.
- b. At the bottom of the ballast layer in the case of rehabilitation by plowing.
- c. At the bottom of the subballast in new construction or rehabilitation where the track is removed.

5-5. Protective Sand layer

a. Although not normally required, a 2-inch-thick layer placed over the geotextile may assist in reducing the abrasion forces caused by the ballast as well as provide an additional filtration layer. In track rehabilitation where undercutting or plowing type of ballast removal operation is used, there may be many large aggregate pieces remaining on the surface of the subgrade prior to the placement of the geotextile. A 2-inch-thick layer of sand placed on the subgrade provides a smooth surface

for the placement of the geotextile and protects the geotextile from punctures and abrasion due to the large aggregate pieces that are on the subgrade.

b. While the use of protective clean sand (less than 5 percent passing the No. 200 sieve) extends service life of a geotextile, there are also several disadvantages. These disadvantages include the extra cost of the sand, the increase in rail height (which results from the extra thickness in the track structure), and the difficulty and cost of placing the sand layer during construction or rehabilitation.

5-6. Drainage

Adequate drainage is the key to a stable railroad track structure. During the design of a new track or a track rehabilitation project, provisions for improving both internal and external track drainage should be included. Drainage provisions that should be considered include adequate (deep) side ditches to handle surface runoff, sufficient crown in both the subgrade and subballast layers to prevent water from ponding on the top of the subballast or subgrade, installation of perpendicular drains to prevent water accumulation in the track, and French drains where required to assist in the removal of water from the track structure. During track rehabilitation, the creation of bathtub or canal effects should be avoided by having the shoulders of the track below the level of the ballast/geotextile/subgrade interface. Geotextiles should not be placed in a railroad track structure until existing drainage problems are corrected. Proper maintenance of railroad drainage facilities is described in TM 5-627.

5-7. Typical Sections

Figure 5-1 presents typical cross sections of the railroad track structure showing the recommended use of a geotextile in the track.

5-8. Special Applications

a. *Installation of Geotextiles Below Natural Ground Level.* In some locations, the elevation of the track structure may be such that the geotextile is placed below the level of the natural ground. Where the natural ground surface is elevated above the geotextile, steps should be taken to prevent the inflow of water. A French drain installed along the edge of the track and lined or completely encapsulated in a geotextile to filter the inflow of surface water may be used to direct water away from the track structure. In extremely flat areas it may be necessary to construct perpendicular side ditches and soak-away pits from the track structure to allow the water to drain out of the French drains. Slotted drain pipes can be

placed in the trenches to facilitate movement of the water from the track.

b. *Highway Grade Crossings.*

(1) Drainage in a grade crossing is generally parallel to the rails until the pavement and road shoulder have been cleared. Once clear of the crossing itself, the drainage should be turned perpendicular to the track and discharged away from the track structure. A perforated drain pipe, either wrapped with a geotextile during installation or prewrapped, may be placed in the trench to assist the flow of water from within the crossing to the ditches outside of the crossing area. Such drainpipes should be placed in the trench with the line of perforations facing downward. The ends of the perforated drainpipes and the geotextile under the crossing should be laid with sufficient fall toward the side ditches to prevent water from ponding in the crossing area. Whether perforated pipes are used or not, the shoulders at the corner of the crossing should be removed, and the ends of the geotextile turned down so that the geotextile facilitates drainage under gravity toward the side ditches.

(2) In cold climates it is common to salt and sand highways, including grade crossings, which can lead to ballast fouling in the grade crossing. One method of preventing or minimizing this ballast fouling is to encapsulate the ballast in a geotextile. The provision for drainage in this type of installation would be the same as discussed above.

c. *Turnout Applications.*

(1) The installation of a geotextile under a turnout is basically the same as installation in any other segment of track. In the vicinity of a switch, drainage of ballast or subballast to ditches is more difficult to achieve because horizontal distances for subsurface flow are about doubled and gradients are about halved. Thus, there are reasons for using geotextiles to promote lateral drainage under a turnout where none is used in adjacent straight sections. If this is done, it should extend at least 25 feet away from the turnout itself to provide a transition section. As with road crossings, particular attention should be given to the removal of surface water from the turnout area.

(2) Many geotextile manufacturers produce specially packaged units ready-made for quick application under turnouts varying from No. 8 to No. 20.

d. *Rail Crossings (Diamonds).* The use of a geotextile in the track under a rail crossing is very similar to the road crossing application. The design and installation process must provide adequate drainage.

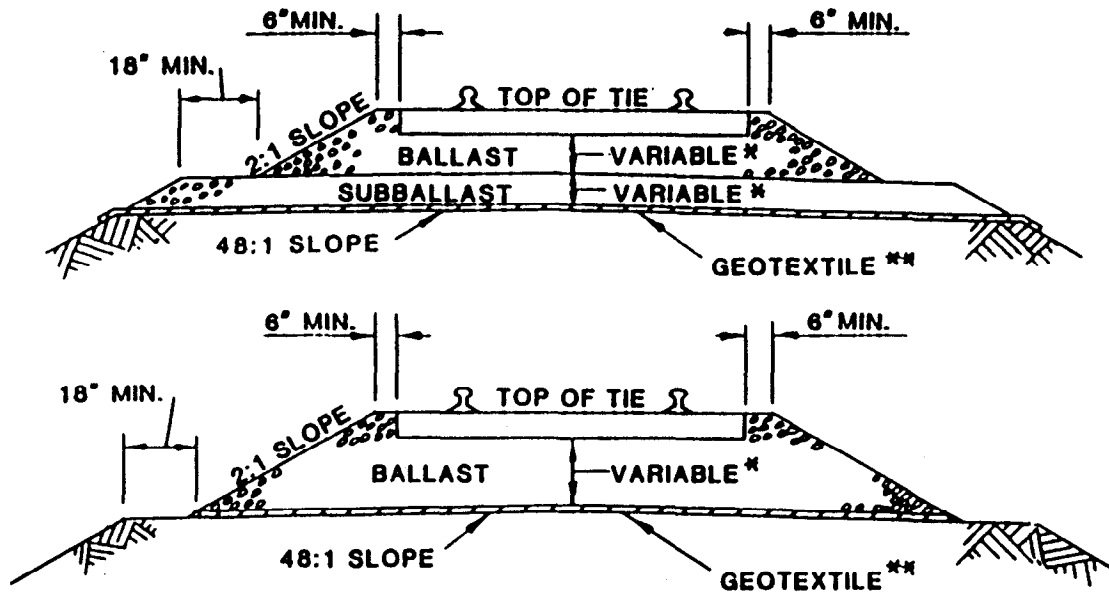

* MINIMUM REQUIREMENTS:

WITHOUT GEOTEXTILE: BALLAST: 12" MINIMUM
 SUBBALLAST: 6" MINIMUM

WITH GEOTEXTILE: TOTAL DEPTH BALLAST/SUBBALLAST
 BETWEEN BOTTOM OF TIE AND GEOTEXTILE: 12" MINIMUM

** PROTECTIVE SAND LAYER ABOVE, BELOW, OR BOTH ABOVE
 AND BELOW IS OPTIONAL.

IF USED, MINIMUM LAYER THICKNESS IS 2"

Figure 5-1. Typical sections of Railroad Track with Geotextile

CHAPTER 6

EROSION AND SEDIMENT CONTROL

6-1. Erosion Control

Erosion is caused by a group of physical and chemical processes by which the soil or rock material is loosened, detached, and transported from one place to another by running water, waves, wind, moving ice, or other geological sheet and bank erosion agents. Clayey soils are less erodible than fine sands and silts. See figure 6-1. This chapter covers the use of geotextiles to minimize erosion caused by water.

6-2. Bank Erosion

Riprap is used as a liner for ditches and channels subjected to high-velocity flow and for lake, reservoir and channel banks subject to wave action. Geotextiles are an effective and economical alternative to conventional graded filters under stone riprap. However, for aesthetic or economic reasons, articulated concrete mattresses, gabions, and pre-cast cellular blocks have also been used to cover the geotextile. The velocity of the current, the height and frequency of waves and the erodibility of the bank determine whether bank protection is needed. The geotextiles used in bank protection serve as a filter. Filter design is covered in chapter 3.

a. Special Design Considerations.

(1) *Durability.* The term includes chemical, biological, thermal, and ultraviolet (UV) stability. Streams and runoff may contain materials that can be harmful to the geotextile. When protected from prolonged exposure to UV light, the common synthetic polymers do not deteriorate or rot in prolonged contact with moisture. All geotextile specifications must include a provision for covering the geotextile to limit its UV radiation exposure to 30 days or less.

(2) *Strength and abrasion resistance.* The required properties will depend on the specific application—the type of the cover material to be used (riprap, sand bags, concrete blocks, etc.), the size, weight, and shape of the armor stone, the handling placement techniques (drop height), and the severity of the conditions (stream velocity, wave height, rapid changes of water level, etc.). Abrasion can result from movement of the cover material as a result of wave action or currents. Strength properties generally considered of primary importance are tensile strength, dimensional stability, tearing, puncture, and burst resistance.

Table 6-1 gives recommended minimum strength values.

(3) *Cover material.* The cover material (gravel, rock fragments, riprap, armor stone, concrete blocks, etc.) is a protective covering over the geotextile that minimizes or dissipates the hydraulic forces, protects the geotextile from extended exposure to UV radiation, and keeps it in intimate contact with the soil. The type, size, and weight of cover material placed over the geotextile depends on the kinetic energy of water. Cover material that is lightweight in comparison with the hydraulic forces acting on it may be moved. By removing the weight holding the geotextile down, the ground-water pressure may be able to separate the geotextile from the soil. When no longer constrained, the soil erodes. The cover material must be at least as permeable as the geotextile. If the cover material is not permeable enough, a layer of fine aggregate (sand, gravel, or crushed stone) should be placed between it and the geotextile. An important consideration in designing cover material is to keep the void area between stones relatively small. If the void area is excessively large, soils may move from areas weighted by stones to unweighted void areas between the stones, causing the geotextile to balloon or eventually rupture. The solution in this case is to place a graded layer of smaller stones below the large stones that will prevent the soil from moving. A layer of aggregate may also be needed if a major part of the geotextile is covered as for example by concrete blocks. The layer will act as a pore water dissipator.

(4) *Anchorage.* At the toe of the streambank, the geotextile and cover material should be placed along the bank to an elevation below mean low water level to minimize erosion at the toe. Placement to a vertical distance of 3 feet below mean low water level, or to the bottom of the streambed for streams shallower than 3 feet, is recommended. At the top of the bank, the geotextile and cover material should either be placed along the top of the bank or with 2 feet vertical freeboard above expected maximum water stage. If strong water movements are expected, the geotextile needs to be anchored at the crest and toe of the streambank (fig 6-2).

(5) If the geotextile must be placed below low water, a material of a density greater than that of water should be selected.

Table 6-1. Recommended Geotextile Minimum Strength Requirements.

Type	Strength Test Method	Class A ¹	Class B ²
Grab Tensile	ASTM D 4632	200	90
Elongation (%)	ASTM D 4632	15	15
Puncture	ASTM D 4833	80	40
Tear	ASTM D 4533	50	30
Abrasion	ASTM D 3884	55	25
Seam	ASTM D 4632	180	80
Burst	ASTM D 3786	320	140

¹ Fabrics are used under conditions more severe than Class B such as drop height less than 3 feet and stone weights should not exceed 250 pounds.

Fabric is protected by a sand cushion or by zero drop height.

b. Construction Considerations.

(1) *Site preparation.* The surface should be cleared of vegetation, large stones, limbs, stumps, trees, brush, roots, and other debris and then graded to a relatively smooth plane free of obstructions, depressions, and soft pockets of materials.

(2) *Placement of geotextiles.* The geotextile is unrolled directly on the smoothly graded soil surface. It should not be left exposed to UV deterioration for more than 1 week in case of untreated geotextiles, and for more than 30 days

in case of UV protected and low UV susceptible polymer geotextiles. The geotextile should be loosely laid, free of tension, folds, and wrinkles. When used for streambank protection, where currents acting parallel to the bank are the principal erosion forces, the geotextile should be placed with the longer dimension (machine direction) in the direction of anticipated water flow. The upper strips of the geotextile should overlap the lower strips (fig 6-3). When used for wave attack or cut and fill slope protection, the geotextile should be placed vertically down the slope (fig 6-3), and the upslope strips should cover the downslope strips. Stagger the overlaps at the ends of the strips at least 5 feet. The geotextile should be anchored at its terminal ends to prevent uplift or undermining. For this purpose, key trenches and aprons are used at the crest and toe of the slope.

(3) *Overlaps, seams, securing pins.* Adjacent geotextile strips should have a minimum overlap of 12 inches along the edges and at the end of rolls. For underwater placement, minimum overlap should be 3 feet. Specific applications may require additional overlaps. Sewing, stapling, heat

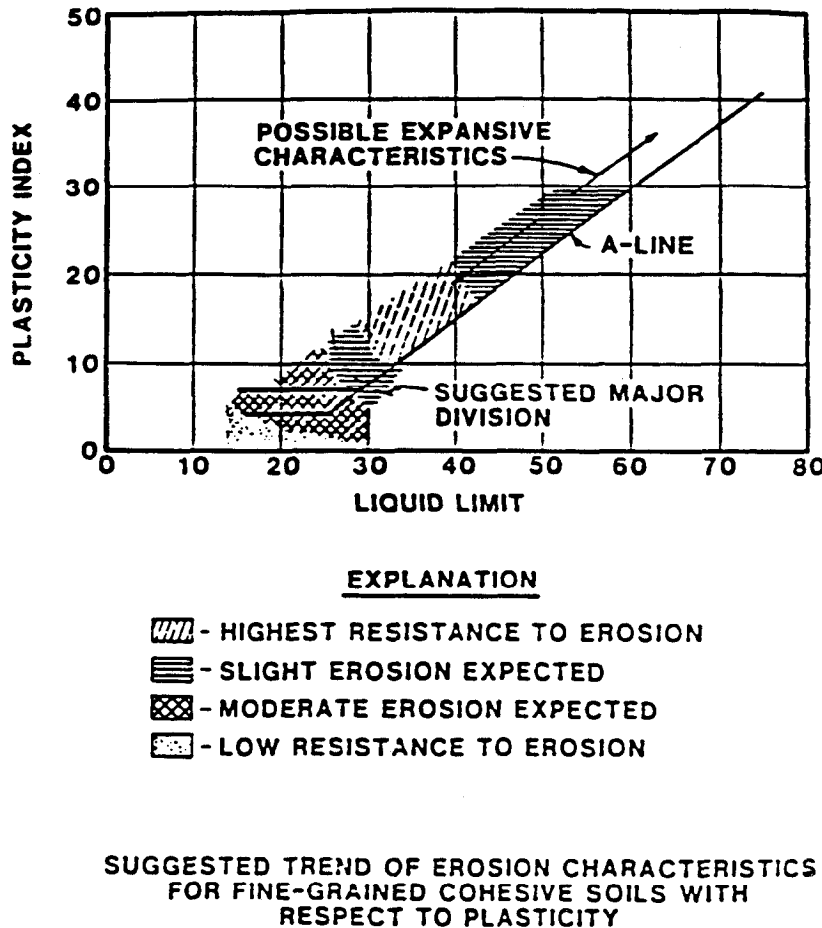

Figure 6-1. Relationship between Atterberg Limits and Expected Erosion Potential.

Table 6-2. Pin Spacing Requirements in Erosion Control Applications.

Slope	Pin Spacing feet
Steeper than 1V on 3H	2
1V on 3H to 1V on 4H	3
Flatter than 1V on 4H	5

V = vertical; H = horizontal.

welding, or gluing adjacent panels, either in the factory or on site, are preferred to lapping only. Sewing has proved to be the most reliable method of joining adjacent panels. It should be performed using polyester, polypropylene, kevlar or nylon thread. The seam strength for both factory and field seams should not be less than 90 percent of the required tensile strength of the unaged geotextile in any principal direction. Geotextiles may be held in place on the slope with securing pins prior to placing the cover material. These pins with washers should be inserted through both strips of the overlapped geotextile along a line through the midpoint of the overlap. The pin spacing, both along the overlaps or seams, depends on the slope, as specified in table 6-2. Steel securing pins, 3/16 inch in diameter, 18 inches long, pointed at one end, and fitted with a 1.5-inch metal washer on the other have performed well in rather firm soils. Longer pins are advisable for use in loose soils. The maximum slope on which geotextiles may be placed will be determined by the friction angles between the natural-ground and geotextile and cover- material and geotextile. The maximum allowable slope in no case can be greater than the lowest friction angle between these two materials and the geotextile.

(4) Placement of cover material on geotextile. For sloped surfaces, placement of the cover stone or riprap should start from the base of the slope moving upward and preferably from the center outward to limit any partial movement of soil because of sliding. In no case should drop heights which damage the geotextile be permitted. Testing may be necessary to establish an acceptable drop height.

6-3. Precipitation Runoff Collection and Diversion Ditches

A diversion ditch is an open, artificial, gravity flow channel which intercepts and collects precipitation runoff, diverts it away from vulnerable areas, and directs it toward stabilized outlets. A geotextile or revegetation mat can be used to line the ditch. It will retard erosion in the ditch, while allowing grass or other protective vegetation growth to take place. The mat or geotextile can serve as additional root anchoring for some time after plant cover has established itself if UV resistant geotextiles are specified. Some materials used for this purpose are designed to degrade after grass growth takes place. The geotextile can be selected and specified using the physical properties indicated in table 6-1 and the filter criteria of chapter 3. Figure 6-4 shows a typical example.

6-4. Miscellaneous Erosion Control

Figures 6-5 and 6-6 show examples of geotextile applications in erosion control at drop inlets and culvert outlets and scour protection around bridges, piers, and abutments. Design criteria similar to that used for bank protection should be used for these applications.

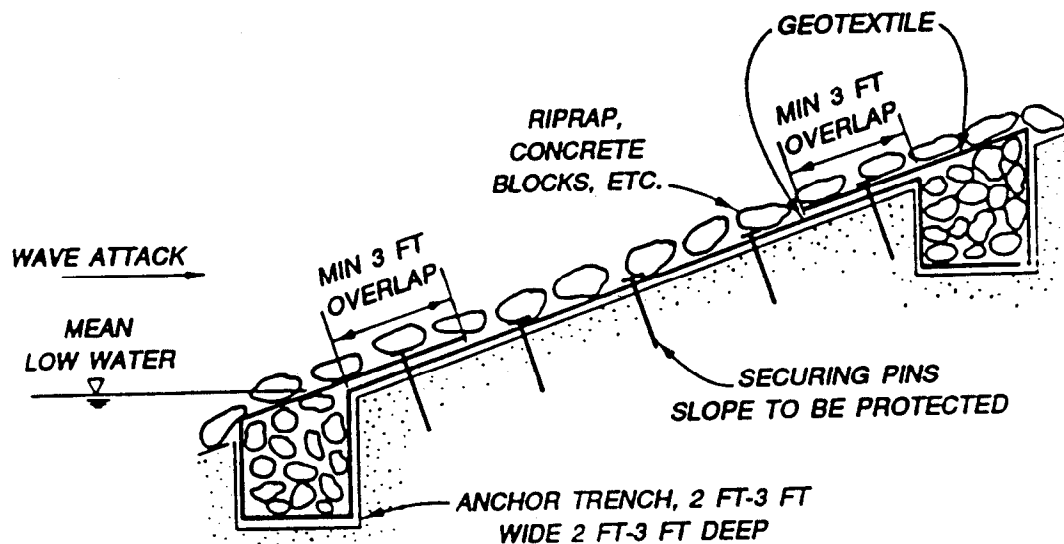

Figure 6-2. Pin Spacing Requirements in Erosion Control Applications.

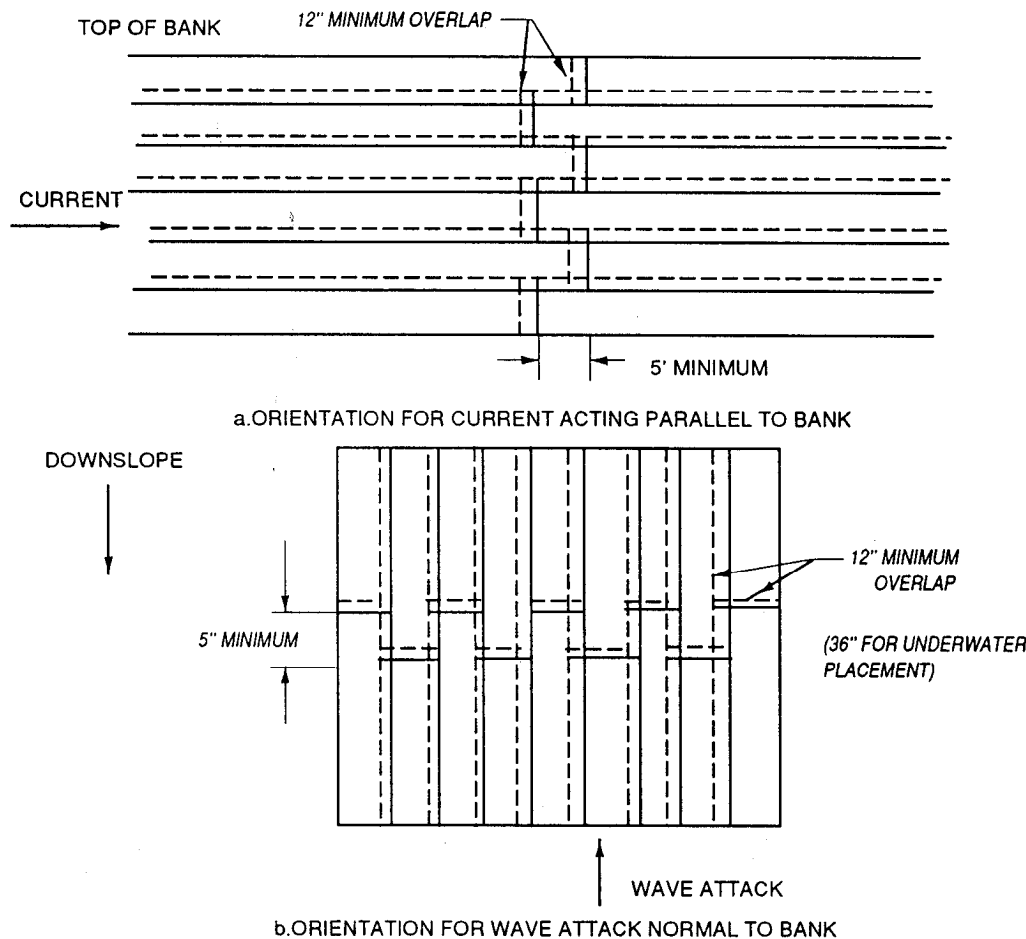

Figure 6-3. Geotextile Placement for Currents Acting Parallel to Bank or for Wave Attack on the Bank.

6-5. Sediment Control

Silt fences and silt curtains are sediment control systems using geotextiles.

a. *Silt Fence*. A silt fence is a temporary vertical barrier composed of a sheet of geotextile supported by fencing or simply by posts, as illustrated in figure 6-5. The lower end of the geotextile is buried in a trench cut into the ground so that runoff will not flow beneath the fence. The purpose of the permeable geotextile silt fence is to intercept and detain sediment from unprotected areas before it leaves the construction site. Silt fence are sometimes located around the entire downslope portion or perimeter of urban construction sites. Short fences are often placed across small drainage ditches (permanent or temporary) constructed on the site. Both applications are intended to function for one or two construction seasons or until grass sod is established. The fence reduces water velocity allowing the sediment to settle out of suspension.

(1) *Design concepts*. A silt fence consists of a sheet of geotextile and a support component. The

support component may be a wire or plastic mesh support fence attached to support posts or in some cases may be support posts only. The designer has to determine the minimum height of silt fences, and consider the geotextile properties (tensile strength, permeability) and external factors (the slope of the surface, the volume of water and suspended particles which are delivered to the silt fence, and the size distribution of the suspended particles). Referring to figure 6-7, the total height of the silt fence must be greater than $h_1 + h_2 + h_3$; where h_1 is the height of geotextile necessary to allow water flowing into the basin to flow through the geotextile, considering the permeability of the geotextile; h_2 is the height of water necessary to overcome the threshold gradient of the geotextile and to initiate flow. For most expected conditions, $h_1 + h_2$ is about 6 inches or less. The silt fence accomplishes its purpose by creating a pond of relatively still water which serves as a sedimentation basin and collects the suspended solids from the runoff. The useful life of the silt fence is the time required to fill the triangular area of height

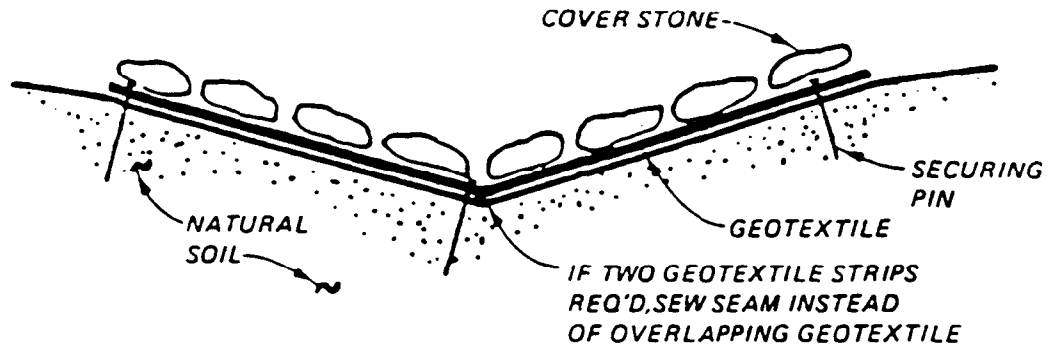

CROSS SECTION OF GEOTEXTILE-LINED DITCH

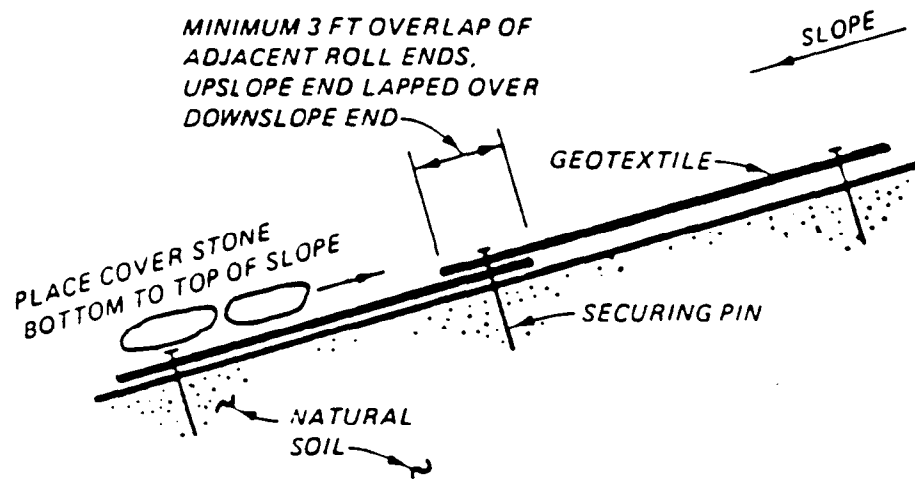

CENTER LINE PROFILE OF GEOTEXTILE-LINED DITCH

Figure 6-4. Ditch Liners.

h (fig 6-7) behind the silt fence with sediment. The height of the silt fence geotextile should not exceed 3 feet.

(2) *Design for maximum particle retention.* Geotextiles selected for use in silt fences should have an AOS that will satisfy the following equation with a limiting value equal to the No. 120 sieve size.

$$\frac{D^{85} \text{ (mm) (soil)}}{\text{AOS (mm) (geotextile)}} \geq 1 \quad (\text{eq 6-1})$$

A minimum of 90-pound tensile strength (ASTM D 4632 Grab Test Method) is recommended for use with support posts spaced a maximum of 8 feet apart.

(3) *Design for filtration efficiency.* The geotextile should be capable of filtering most of the soil particles carried in the runoff from a construction site without unduly impeding the flow. ASTM D 5141 presents the laboratory test used to determine the filtering efficiency and the flow rate of

the sediment-filled water through the geotextile.

(4) *Required geotextile properties.* The geotextile used for silt fence must also have:

(a) Reasonable puncture and tear resistance to prevent damage by floating debris and to limit tearing where attached to posts and fence.

(b) Adequate resistance to UV deterioration and biological, chemical, and thermal actions for the desired life of the fence.

(5) *Construction considerations.*

(a) Silt fences should be constructed after the cutting of trees but before having any sod disturbing construction activity in the drainage area.

(b) It is a good practice to construct the silt fence across a flat area in the form of a horseshoe. This aids in the ponding of the runoff, and increases the strength of the fence. Prefabricated silt fence sections containing geotextile and support posts are commercially available. They are generally manufactured in heights of 18 and 36 inches.

At the lower portion of the silt fence, the geotextile is extended for burying anchorage.

b. Silt Curtains. A silt curtain is a floating vertical barrier placed within a stream, lake, or other body of water generally at runoff discharge points. It acts as a temporary dike to arrest and control turbidity. By interrupting the flow of water, it retains suspended particles; by reducing the velocity, it allows sedimentation. A silt curtain is composed of a sheet of geotextile maintained in a vertical position by flotation segments at the top and a ballast chain along the bottom. A tension cable is often built into the curtain immediately above or below the flotation segments to absorb stress imposed by currents and other hydrodynamic forces. Silt curtain sections are usually

about 100 feet long and of any required width. An end connector is provided at each end of the section for fastening sections together. Anchor lines hold the curtain in a configuration that is usually U-shaped, circular, or elliptical. The design criteria and properties required for silt fences also apply to silt curtains. Silt curtains should not be used for:

- (1) Operations in open ocean.
- (2) Operations in currents exceeding 1 knot.
- (3) Areas frequently exposed to high winds and large breaking waves.
- (4) Around hopper or cutterhead dredges where frequent curtain movement would be necessary.

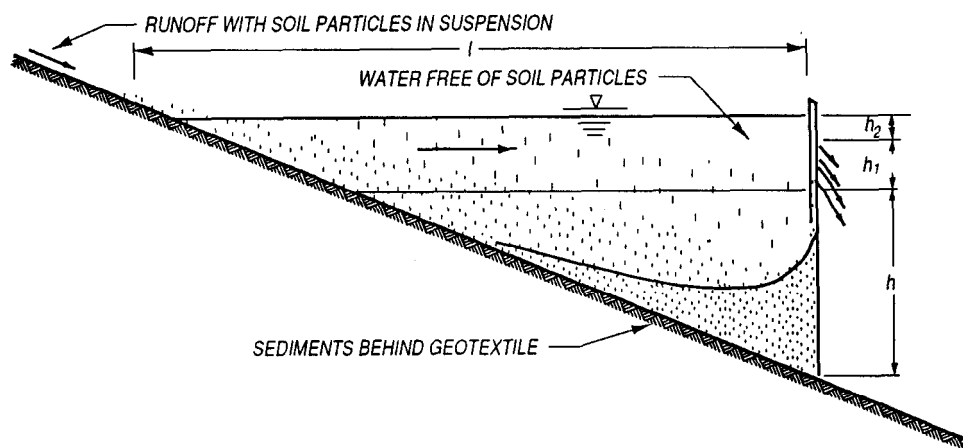

Figure 6-5. Use of Geotextiles near Small Hydraulic Structures.

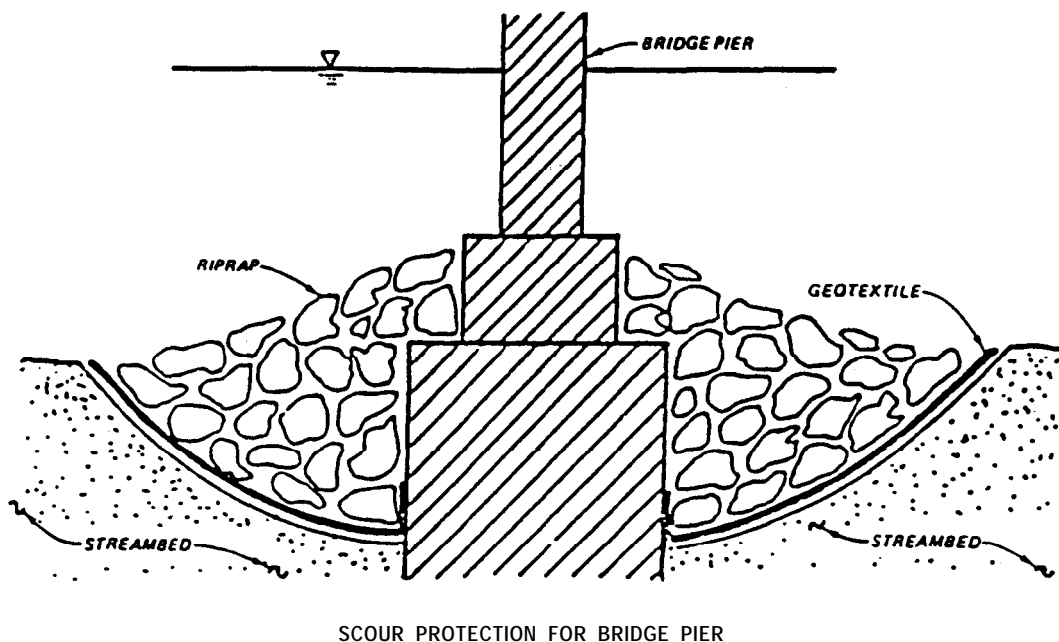

Figure 6-6. Use of Geotextiles around Piers and Abutments.

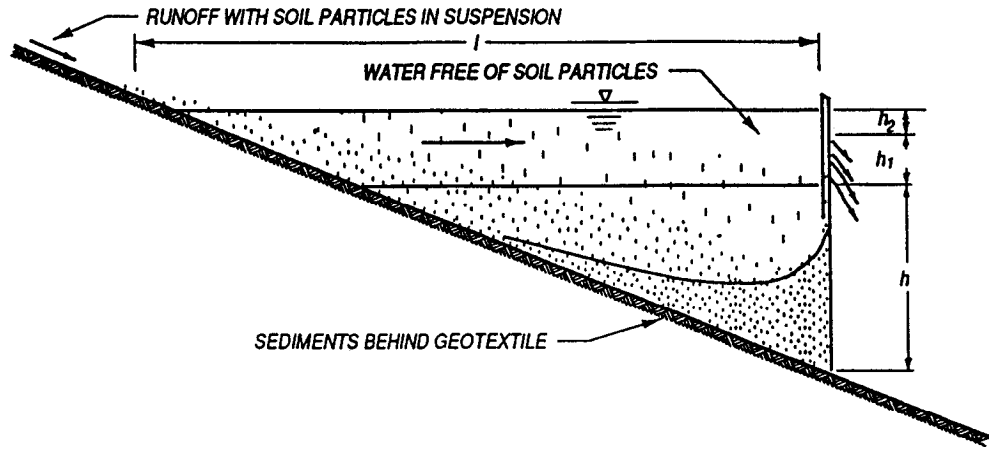

Figure 6-7. Sedimentation behind Silt Fence.

CHAPTER 7

REINFORCED SOIL WALLS

7-1. Geotextile-Reinforced Soil Walls

Soil, especially granular, is relatively strong under compressive stresses. When reinforced, significant tensile stresses can be carried by the reinforcement, resulting in a composite structure which possesses wider margins of strength. This extra strength means that steeper slopes can be built. Geotextiles have been utilized in the construction of reinforced soil walls since the early 1970's. Geotextile sheets are used to wrap compacted soil in layers producing a stable composite structure. Geotextile-reinforced soil walls somewhat resemble the popular sandbag walls which have been used for some decades. However, geotextile-reinforced walls can be constructed to significant height because of the geotextile's higher strength and a simple mechanized construction procedure.

7-2. Advantages of Geotextile-Reinforced Walls

Some advantages of geotextile-reinforced walls over conventional concrete walls are the following:

- a. They are economical.
- b. Construction usually is easy and rapid. It does not require skilled labor or specialized equipment. Many of the components are prefabricated allowing relatively quick construction.
- c. Regardless of the height or length of the wall, support of the structure is not required during construction as for conventional retaining walls.
- d. They are relatively flexible and can tolerate large lateral deformations and large differential vertical settlements. The flexibility of geotextile-reinforced walls allows the use of a lower factor of safety for bearing capacity design than for conventional more rigid structures.
- e. They are potentially better suited for earthquake loading because of the flexibility and inherent energy absorption capacity of the coherent earth mass.

7-3. Disadvantages of Geotextile-Reinforced Walls

Some disadvantages of geotextile-reinforced walls over conventional concrete walls are the following:

- a. Some decrease in geotextile strength may occur because of possible damage during construction.
- b. Some decrease in geotextile strength may occur with time at constant load and soil temperature.

c. The construction of geotextile-reinforced walls in cut regions requires a wider excavation than conventional retaining walls.

d. Excavation behind the geotextile-reinforced wall is restricted.

7-4. Uses

Geotextile-reinforced walls can be substantially more economical to construct than conventional walls. However, since geotextile application to walls is relatively new, long term effects such as creep, aging, and durability are not known based on actual experience. Therefore, a short life, serious consequences of failure, or high repair or replacement costs could offset a lower first cost. Serious consideration should be given before utilization in critical structures. Applications of geotextile-reinforced walls range from construction of temporary road embankments to permanent structures remedying slide problems and widening highways effectively. Such walls can be constructed as noise barriers or even as abutments for secondary bridges. Because of their flexibility, these walls can be constructed in areas where poor foundation material exists or areas susceptible to earthquake activity.

7-5. General Considerations

a. The wall face may be vertical or inclined. This can be because of structural reasons (internal stability), ease of construction, or architectural purposes. All geotextiles are equally spaced so that construction is simplified. All geotextile sheets, except perhaps for the lowest one, usually extend to the same vertical plane.

b. Geotextiles exposed to UV light may degrade quite rapidly. At the end of construction, a protective coating should be applied to the exposed face of the wall. An application of 0.25 gallon per square yard of CSS-1 emulsified asphalt or spraying with a low viscosity water-cement mixture is recommended. This cement mixture bonds well and provides satisfactory protection even for smooth geotextiles. To protect the face of the wall from vandalism, a 3-inch layer of gunnite can be applied. This can be done by projecting concrete over a reinforcing mesh manufactured from No. 12 wires, spaced 2 inches in each direction, supported by No. 3 rebars inserted between geotextile layers to a depth of 3 feet.

c. When aesthetic appearance is important, a low-cost solution like the facing system comprised of used railroad ties or other such materials can be used.

d. No weepholes are specified, although after UV and vandal protection measures the wall face may be rather impermeable. To ensure the fast removal of seeping water in a permanent structure, it is recommended to replace 1 to 2 feet of the natural foundation soil (in case it is not free-draining) with a crushed-stone foundation layer to facilitate drainage from within and behind the wall. The crushed rock may be separated from the natural soil by a heavy weight geotextile meeting filter criteria of chapter 3.

7-6. Properties of Materials

a. *Retained Soil.* The soil wrapped by the geotextile sheets is termed "retained soil." This soil must be free-draining and nonplastic. The ranking (most desirable to less desirable) of various retained soils for permanent walls using the Unified Soil Classification System is as follows: SW, SP, GW, GP, and any of these as a borderline classification which is dual designated with GM or SM. The amount of fines in the soil is limited to 12 percent passing sieve No. 200. This restriction is imposed because of possible migration of fines being washed by seeping water. The fines may be trapped by geotextile sheets, thus eventually creating low permeability liners. Generally, the permeability of the retained soil must be more than 10⁻³

centimeters per second. The ranking order indicates that gravels are not at the top. Although they possess high permeability and, possibly, high strength, their utilization requires special attention. Gravel, especially if it contains angular grains, can puncture the geotextile sheets during construction. Consequently, consideration must be given to geotextile selection so as to resist possible damage. If a geotextile possessing high puncture resistance is available, then GP and GW should replace SP and SW, respectively, in their ranking order. The retained soil unit weight should be specified based on conventional laboratory compaction tests. A minimum of 95 percent of the maximum dry unit weight, as determined by ASTM D 698 should be attained during construction. Since the retained soil will probably be further densified as additional layers are placed and compacted, and may be subjected to transitional external sources of water, such as rainfall, it is recommended for design purposes that the saturated unit weight be used.

b. *Backfill Soil.* The soil supported by the reinforced wall (the soil to the right of L in figure 7-1) is termed "backfill soil." This soil has a direct effect on the external stability of the wall. Therefore, it should be carefully selected. Generally, backfill specifications used for conventional retaining walls should be employed here as well. Clay, silt, or any other material with low permeability should be avoided next to a permanent wall. If low quality materials are used, then a geotextile filter

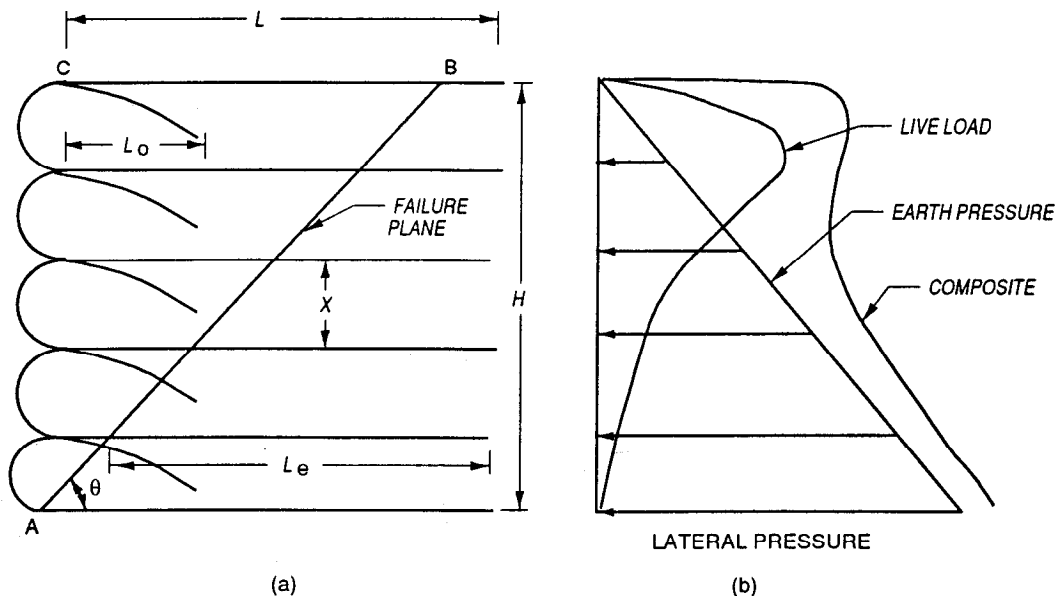

Figure 7-1. General Configuration of a Geotextile Retained Soil Wall and Typical Pressure Diagrams.

meeting filtration requirements of chapter 3 should be placed to separate the fines from the free draining backfills, thus preventing fouling of the higher quality material. Since the retained soil and backfill may have an effect on the external stability of the reinforced wall, the properties of both materials are needed. The unit weight should be estimated as for the retained soil; use the maximum density at zero air voids. The strength parameters should be determined using drained direct shear tests (ASTM D 3080) for the permeable backfill. The backfill and the retained soil must have similar gradation at their interface so as to minimize the potential for lateral migration of soil particles. If such requirement is not practical, then a conventional soil filter should be designed, or a geotextile filter used along the interface.

7-7. Design Method

The design method recommended for retaining walls reinforced with geotextiles is basically the U.S. Forest Service method as developed by Steward, Williamson, and Mahoney (1977) using the Rankine approach. The method considers the earth pressure, line load pressure, fabric tension, and pullout resistance as the primary design parameters.

a. *Earth Pressure.* Lateral earth pressure at any depth below the top of the wall (fig 7-1a) is given by:

$$\sigma_{ho} = K_o \gamma d \tag{eq 7-1}$$

where

- σ_{ho} = lateral earth pressure acting on the wall
- K_o = at rest pressure coefficient
- γ = soil unit weight
- d = depth below the top of the wall

A typical earth pressure distribution is shown in figure 7-1b. Use of the "at rest" pressure coefficient, K_o , is recommended and is determined by the following equation:

$$k_o = 1 - \sin \phi \tag{eq 7-2}$$

where ϕ is the angle of internal friction of the soil. The failure surface, AB in figure 7-1a, slopes upward at an angle of $\theta = 45 + \theta/2$.

b. *Live Load Pressure.* Lateral pressures from live loads are calculated for a point load acting on the surface of the backfill using the following equation:

$$\sigma_{hl} = P x^2 z / R^5 \tag{eq 7-3}$$

where

- P = vertical load
- x = horizontal distance from load to wall and perpendicular to the wall

z = vertical distance from load to point where stress is being calculated

$$R = \sqrt{x^2 + y^2 + z^2}$$

y = horizontal distance from load to wall, and parallel to the wall

A typical live load pressure distribution is shown in figure 7-1b. Figure 7-2 illustrates live load stress calculations.

c. *Fabric Tension.* Tension in any fabric layer is equal to the lateral stress at the depth of the layer times the face area that the fabric must support. For a vertical fabric spacing of X, a unit width of fabric at depth d must support a force of $\sigma_h X$, where σ_h is the average total lateral pressure (composite of dead plus live load) over the vertical interval X.

d. *Pullout Resistance.* A sufficient length of geotextile must be embedded behind the failure plane to resist pullout. Thus, in Figure 7-1a, only the length, L_e , of fabric behind the failure plane AB would be used to resist pullout. Pullout resistance can be calculated from:

$$P_A = 2d\gamma \text{ TAN } 2/3 \phi \tag{eq 7-4}$$

where

- P_A = pullout resistance
- d = depth of retained soil below top of retaining wall
- γ = unit weight of retained soil
- ϕ = angle of internal friction of retained soil
- L_e = length of embedment behind the failure plane

It can be seen from this expression that pullout resistance is the product of overburden pressure, γd , and the coefficient of friction between retained soil and fabric which is assumed to be $\text{TAN } 2/3 \phi$. This resistance is in pounds per square foot which is multiplied by the surface area of $2L_e$ for a unit width. Where different soils are used above and below the fabric layer, the expression is modified to account for different coefficients of friction for each soil:

$$P_A = d \gamma (\text{TAN } 2/3 \phi_1 + \text{TAN } 2/3 \gamma_2) \tag{eq 7-5}$$

7-8. Design Procedure

The recommended design procedure is discussed in the following steps. The calculations for the fabric dimensions for overlap, embedment length and vertical spacing should include a safety factor of 1.5 to 1.75 depending upon the confidence level in the strength parameters.

a. *Retained Soil Properties ϕ and γ .* Only free-draining granular materials should be used as retained soil. The friction angle, ϕ , will be determined using the direct shear (ASTM D 3080)

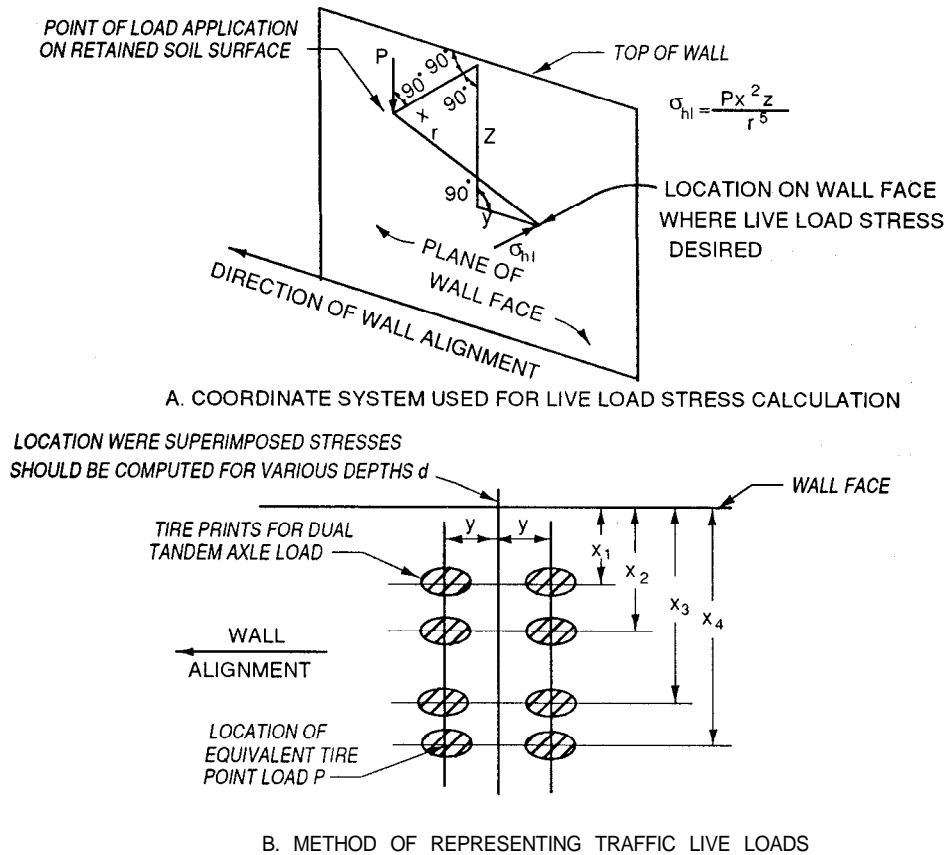

Figure 7-2. Procedures for Computing Live Load Stresses on Geotextile Reinforced Retaining Walls.

or triaxial tests (ASTM D 2850). The unit weight, γ , will be determined in a moisture density test (ASTM D 698). Generally, 95 percent of ASTM D 698 maximum density can be easily attained with granular materials. However, other densities can be specified so long as the friction angle used is consistent with that density. The saturated unit weight is used in lateral pressure calculations.

b. Lateral Earth Pressure Diagram. Using the properties of the retained soil, calculate the pressure coefficient, $K_o = 1 - \sin \phi$. The lateral earth pressure expression:

$$\sigma_{ho} = K_o \gamma h$$

is used to calculate the triangular shaped pressure distribution curve for the height of retaining wall desired.

c. Live Load Lateral Pressure Diagram. It is first necessary to determine the design load. Lateral pressure diagrams must be developed for each vehicle or other equipment expected to apply loads to the retaining wall using equation 7-3. The equation is solved for each wheel and the results added to obtain the lateral pressure. This pressure is calculated at 2-foot vertical intervals over the height of the retaining wall. Normally, from one to

three locations along the wall are checked to determine the most critical.

d. Composite Pressure Diagram. The earth pressure and live load pressure diagrams are combined to develop the composite diagram used for design as shown in Figure 7-1b.

e. Vertical Spacing of the Fabric Layer. To determine the vertical strength of the fabric layer, the fabric allowable tensile strength, S , is set equal to the lateral force calculated from $\sigma_h X$, where σ_h is the lateral pressure at the middle of the layer. Thus, knowing the fabric tensile strength, and value of σ_h , the fabric vertical spacing, X , can be calculated. The fabric strength should be divided by the appropriate safety factor. The equation for fabric spacing is:

$$X = \frac{S}{(F.S.)\sigma_h} \tag{eq 7-6}$$

f. Length of Fabric Required to Develop Pullout Resistance. The formula for pullout resistance, $P_A = 2d\gamma \tan^2 \frac{\phi}{2} L_e$, is used to solve for the pullout resistance which can be developed at a given depth geotextile length combination or to solve for d , the depth required to develop P_A . The usual case for walls is to set P_A equal to the geotextile

strength and solve for L_e , the length of geotextile required. Thus, the expression would be:

$$L_e = \frac{P_A (\text{F.S.})}{(2 d \gamma \text{TAN } 2/3 \phi)} \quad (\text{eq 7-7})$$

where

P_A = fabric tensile strength
 F.S. = safety factor of 1.5 to 1.75

The minimum length of the fabric required is 3 feet.

g. Length of Fabric Overlap for the Folded Portion of Fabric at the Face. The overlap, L_o , must be long enough to transfer the stress from the lower section of geotextile to the longer layer above. The pullout resistance of the geotextile is given by:

$$f = d_F \gamma \text{TAN } 2/3 \phi L_o \quad (\text{eq 7-8})$$

where d_F = depth to overlap. Tension in the geotextile is:

$$T = \sigma_h \left(\frac{X}{2} \right) \quad (\text{eq 7-9})$$

Since the factor of safety can be expressed as:

$$\text{F.S.} = \frac{f}{T} = \frac{d_F \gamma \text{TAN } 2/3 \phi L_o}{\sigma_h \left(\frac{x}{2} \right)} \quad (\text{eq 7-10})$$

This can be solved for the length of overlap, required:

$$L_o = \frac{\sigma_h X (\text{F.S.})}{2 d_F \gamma \text{TAN } 2/3 \phi} \quad (\text{eq 7-11})$$

The minimum length of overlap should be 3 feet to ensure adequate contact between layers.

h. External Wall Stability. Once the internal stability of the structure is satisfied, the external stability against overturning, sliding and foundation bearing capacity should be checked. This is accomplished in the same manner as for a retaining wall without a geotextile. Overturning loads are developed from the lateral pressure diagram for the back of the wall. This may be different from the lateral pressure diagram used in checking internal stability, particularly due to placement of live loads. Overturning is checked by summing moments of external forces about the bottom at the face of the wall. Sliding along the base is checked by summing external horizontal forces. Bearing capacity is checked using standard foundation bearing capacity analysis. Theoretically, the fabric layers at the base could be shorter than at the top. However, because of external stability considerations, particularly sliding and bearing capacity, all fabric layers are normally of uniform width.

APPENDIX A

REFERENCES

Government Publications

Departments of the Army and the Air Force

- | | |
|---|--|
| TM 5-820-2/AFJMAN 32-1016 | Drainage and Erosion Control Subsurface Drainage Facilities for Airfield Pavements |
| TM 5-822-5/AFJMAN 32-1018 | Pavement Design for Roads, Streets, Walks, and Open Storage Areas |
| TM 5-850-2/AFJMAN 32-1014 | Flexible Pavement Design for Airfields |
| TM 5-825-3/AFJMAN 32-1014 | Rigid Pavements for Airfields |
| TM 5-850-2/AFJMAN 32-1046 | Railroad Design and Construction at Army and Air Force Installations |
| TM 5-627 | Maintenance of Trackage |
| <i>Federal Highway Administration, 400 Seventh Street, SW, Washington, DC</i> | |
| FHWA-HI-90-001 | Geotextile Design and Construction Guidelines October, 1989 |
| <i>United States Department of Agriculture Forest Service, Portland, Oregon</i> | |
| Guidelines for Use of Fabrics in Construction and Maintenance of Low Volume Roads (June 1977) | |

Nongovernment Publications

- | | |
|---|--|
| <i>American Society for Testing and Materials (ASTM), 1916 Race St., Philadelphia, PA 19103</i> | |
| D 276-93 | Identification of Fibers in Textiles |
| D 698-91 | Laboratory Compaction Characteristics of Soil Using Standard Effort |
| D 1557-91 | Laboratory Compaction Characteristics of Soil Using Modified Effort |
| D 1683-90 | Failure in Sewn Seams of Woven Fabrics |
| D 2850-87 | Unconsolidated, Undrained Strength of Cohesive Soils in Triaxial Compression |
| D 3080-90 | Direct Shear Test of Soils Under Consolidated Drained Conditions |
| D 3776-85 (1990) | Mass per Unit Area (Weight) of Woven Fabric |
| D 3786-87 | Hydraulic Bursting Strength of Knitted Goods and Nonwoven Fabrics-Diaphragm Bursting Strength Tester Method |
| D 4355-92 | Deterioration of Geotextiles from Exposure to Ultraviolet Light and Water (Xenon-Arc Type Apparatus) |
| D 4491-92 | Water Permeability of Geotextiles by Permittivity |
| D 4533-91 | Trapezoid Tearing Strength of Geotextiles |
| D 4595-93 | Tensile Properties of Geotextiles by the Wide Strip Method |
| D 4632-91 | Breaking Load and Elongation of Geotextiles (Grab Method) |
| D 4716-87 | Constant Head Hydraulic Transmissivity (In-Plane Flow) of Geotextiles and Geotextile Related Products |
| D 4751-87 | Determining the Apparent Opening Size of a Geotextile |
| D 4833-88 | Index Puncture Resistance of Geotextiles, Geomembranes, and Related Products |
| D 5101-90 | Measuring the Soil Geotextile System Clogging Potential by the Gradient Ratio |
| D 5141-91 | Determining Filtering Efficiency and Flow Rate of a Geotextile for Silt Fence Application Using Site Specific Soil |

American Association of State Highway and Transportation Officials, 444 N. Capitol Street, N.W.,
Suite 225, Washington, DC 20001
M 288-90

Standard Specification for Geotextiles, Asphalt Retention,
and Area Change of Paving Engineering Fabrics

BIBLIOGRAPHY

- Al-Hussaini, M. M., "Field Experiment of Fabric Reinforced Earth Wall," *Proceedings of the International Conference on the Use of Fabrics in Geotechnics*, Paris, Apr 20-22, Vol. 1, pp. 119-121, 1977.
- Al-Hussaini, M., and Perry, E. B., "Analysis of A Rubber- Membrane Strip Reinforced Earth Wall," Soil Reinforcing and Stabilizing Techniques in Engineering Practice, *Proceedings of a Symposium Jointly Organized by the New South Wales Institute of Technology and the University of New South Wales*, Sydney, Australia, 1978.
- Andrawes, K. Z., McGowan, A., Wilson-Fahmy, R. F., and Mashhour, M. M., "The Finite-Element Method of Analysis Applied to Soil-Geotextile Systems," *Proceedings of the 2nd International Conference on Geotextiles*, Las Vegas, Aug 1-6, Vol. 3, pp. 695-700, 1982.
- Baker, R., "Tensile Strength, Tension Cracks and Stability of Slopes," *Soils and Foundations, Journal of the Japanese Society of Soil Mechanics and Foundations Engineering*, Vol. 21, No. 2, pp. 1-17, 1981.
- Baker, R., and Garber, M., "Variational Approach to Slope Stability," *Proceedings of the 9th International Conference on Soil Mechanics and Foundation Engineering*, Vol. 2, pp. 9-12, Tokyo, 1977.
- Baker, R., and Garber, M., "Theoretical Analysis of the Stability of Slopes," *Geotechnique*, Vol. 28, No. 4, pp. 395-411, 1978.
- Barrett, R. K., "Geotextiles in Earth Reinforcement," *Geotechnical Fabrics Report*, Mar/Apr, Vol. 3, No. 2, pp. 15-99, 1988.
- Bell, J. R., Barrett, R. K., and Ruckman, A. C., "Geotextile Earth-Reinforced Retaining Wall Tests: Glenwood Canyon, Colorado," *Transportation Research Record*, 916, pp. 59-69, 1983.
- Bell, J. R., Greenway, D. R., and Vischer, W., "Construction and Analysis of a Fabric-Reinforced Low Embankment on Muskeg," *Proceedings, International Conference on the Use of Fabrics in Geotechniques*, Paris, Vol. 1, pp. 71-76, 1977.
- Bell, J. R., and Hicks, R. G., "Evaluation of Test Methods and Use Criteria for Geotechnical Fabrics in Highway Applications, Final Report," Federal Highway Administration, Washington, DC, 1983.
- Bell, J. R., and Steward, J. E., "Construction and Observation of Fabric Retained Soil Walls," *Proceedings of the International Conference on the Use of Fabrics in Geotechnics*, April 20-22, Vol. 1, pp. 123-128, 1977.
- Bell, J. R., Stillely, A. N., and Vandre, B., "Fabric Retained Earth Walls," *Proceedings of the 13th Annual Engineering Geology and Soils Engineering Symposium*, University of Idaho, Moscow, Idaho, April 2-4, pp. 271-287, 1975.
- Blair, J. C., Bell, J. R., and Hicks, R. G., "Permeability Testing of Geotextiles," *Transportation Research Record*, 826, pp. 1-6, 1981.
- Broms, B. B., "Design of Fabric Reinforced Retaining Structures," *Proceedings of the Symposium on Earth Reinforcement*, American Society of Civil Engineers, Pittsburgh, Penn., 1978.
- Campbell, D. H., et al., "Erosion Objective: Storm Water Drainage Channel Needs Erosion Protection," *Geotechnical Fabrics Report*, p. 20, 1985.
- Cedergren, H. R., *Seepage, Drainage, and Flownets*, Wiley, New York, 1977.
- Chassie, R. G., "Geotextile Retaining Walls: Some Case History Examples," paper prepared for presentation at the 1984 NW Roads and Streets Conference, Corvallis, Oreg., 1984.
- Chen, W. F., *Limit Analysis and Soil Plasticity*, Elsevier Pub., Amsterdam, The Netherlands, 1975.
- Christie, I. F., and E-Hadi, K. M., "Some Aspects of the Design of Earth Dams Reinforced with Fabric," *Proceedings of the International Conference on the Use of Fabrics in Geotechnics*, Paris, April 20-22, Vol. 1, pp. 99-103, 1977.
- Christopher, B. R. 1983. "Evaluation of Two Geotextile Installations in Excess of a Decade Old," *Transportation Research Record* 916, National Academy of Sciences, Washington, DC, p 79-88.
- Christopher, B. R., and Holtz, R. D., "Geotextile Engineering Manual," Report No. FHWA-TS-861203, STS Consultants Ltd, Northbrook, Ill under contract FHWA No. DTFH61-83-C-00094, 1984.
- Civil Works Construction Guide Specification, No. CW 02215, "Plastic Filter Fabric," Department of the Army Corps of Engineers, Office of the Chief of Engineers, Washington, DC, 1986.
- Couch, F. B., Jr., "Geotextile Applications to Slope Protection for the Tennessee-Tombigbee Waterway Divide Cut," Second International Conference on Geotextiles, Las Vegas, Nev., 1982.
- Coutermarsh, B. A. and G. Phetteplace, "Numerical Analysis of Frost Shields," in Proceedings, American Society of Civil Engineers/Canadian Geotechnical Society Sixth International Cold Regions Specialty

- Conference, W. Lebanon, NH, February 26-28, 1991, p. 178-190.
- Coutermarsh, B. A. and G. Phetteplace, "Analysis of Frost Shields Using the Finite Element Method," Seventh International Conference on Numerical Methods in Thermal Problems, Stanford, CA, Pineridge Press, Swansea, UK, p. 123-132.
- De Ment, L. E., "Two New Methods of Erosion Protection for Louisiana," *Shore Beach*, Vol. 45, No. 1, p. 8, 1977.
- Douglas, G. E., "Design and Construction of Fabric-Reinforced Retaining Walls by New York State," *Transportation Research Record*, 872, pp. 32-37, 1982.
- El-Fermaoui, A., and Nowatzki, E., "Effect of Confining Pressure on Performance of Geotextiles in Soils," *Proceedings of the 2nd International Conference on Geotextiles*, Las Vegas, Aug 1-6, Vol. 3, pp. 799-804, 1982.
- Engineering and Design, "Use of Geotextiles Under Riprap," Engineer Technical Letter No. 1110-2-286, Department of the Army, US Army Corps of Engineers, Washington, DC, 1984.
- Ford, H. W., "Estimating the Potential for Ochre Clogging Before Installing Drains," *Transactions of the American Society of Civil Engineers* 25(6), pp. 1597-1600, 1982a.
- Ford, H. W., "Some Fundamentals of Iron and Slime Deposition in Drains," *Proceedings of the Second International Drainage Workshop*, Washington, DC, pp. 207-212, 1982b.
- Fowler, Jack, "Analysis of Fabric-Reinforced Embankment Test Section at Pinto Pass, Mobile, Alabama," thesis submitted in partial fulfillment of the requirements for the degree of Doctor of Philosophy, Oklahoma State University, Stillwater, Okla., 1979.
- Fowler, J., "Theoretical Design Considerations for Fabric-Reinforced Embankments," *Proceedings of the 2nd International Conference on Geotextiles*, Las Vegas, Aug 1-6, Vol. 3, pp. 665-670, 1982.
- Geotextiles and Geomembranes*, T. S. Ingold, Ed., published by Elsevier Applied Science Publishers, Essex, England, containing articles on geotextiles and geomembranes, began publication in 1984.
- Geotechnical Fabrics Report*, Published by Industrial Fabrics Association International since 1981, St. Paul, Minn.
- Giroud, J. P., "Filter Criteria for Geotextiles," *Proceedings of the Second International Conference on Geotextiles*, Vol. I, pp. 103-108, 1982.
- Gulden, W., and Brown, D., "Treatments for Reduction of Reflective Cracking of Asphalt Overlays on Jointed-Concrete Pavements in Georgia," *Transportation Research Record* 916, Transportation Research Board, Washington, DC, 1983.
- Haliburton, T. A., "Design of Test Section for Pinto Pass Dike, Mobile, Alabama," Report prepared by Haliburton Associates, Stillwater, Okla., under Contract No. DACW01-78-C-0092, for US Army Engineer District, Mobile, Ala., 1978.
- Haliburton, T. A., "Evaluation of Construction Procedure for Fabric-Reinforced Embankment Test Section, Pinto Pass, Mobile Harbor, Alabama," conducted by Haliburton Associates, Stillwater, Okla., under Contract No. DACW39-78-M-4002, for US Army Engineer Waterways Experiment Station, Vicksburg, Miss., 1979.
- Haliburton, T. A., Anglin, C. C., and Lawmaster, J. D., "Selection of Geotechnical Fabrics for Embankment Reinforcement," School of Civil Engineering, Oklahoma State University, Stillwater, Okla., 1978.
- Haliburton, T. A., Fowler, J., and Langan, J. P., "Design and Construction of Fabric-Reinforced Embankment Test Section at Pinto Pass, Mobile, Alabama," *Transportation Research Record*, 249, pp. 27-34, Washington, DC, 1980.
- Haliburton, T. A., Lawmaster, J. D., and King, J. J., "Potential Use of Geotechnical Fabric in Airfield Runway Design," Contract No. AFOSR79-00871, Air Force Office of Scientific Research, School of Civil Engineering, Oklahoma State University, Stillwater, Okla., 1980.
- Haliburton, T. A., Lawmaster, J. D., and McGuffie, V. C., "Use of Engineering Fabrics in Transportation Related Applications," Haliburton Associates Engineering Consultants, Under Contract No. DTFH-80-C-0094, Stillwater, Okla., 1981.
- Hammer, D. P., and Blackburn, E. D., "Design and Construction of Retaining Dikes for Containment of Dredged Material," Technical Report TR-D-77-9, US Army Engineer District, Savannah, Savannah, Ga., 1977.
- Henry, K. S., "Geotextiles as Capillary Barriers," *Geotechnical Fabrics Report*, March/April, pp. 30-36.
- Henry, K. S., "Laboratory Investigation of the Use of Geotextiles to Mitigate Frost Heave," CRREL Report 90-6, CRREL, Hanover, NH USA, 28 p.

- Henry, K. S., "Use of Geotextiles to Mitigate Frost Heave in Soils," in Proceedings, V International Conference on Permafrost in Trondheim, Norway, Vol. 2, p. 1096-1011.
- Henry, K. S., S. Taylor and J. Ingersoll, "Effects of Freezing on the Microstructure of Two Geotextiles," in Geosynthetics: Microstructure and Performance, ASTM STP 1076, pp. 147-164.
- Henry, Karen S., "Effect of Geotextiles on Water Migration in Freezing Soils and the Influence of Freezing on Performance," Proceedings, Geosynthetics, 91, Atlanta, GA, Industrial Fabrics Association International, St. Paul, MN.
- Horz, R. C., "Geotextiles for Drainage, Gas Venting, and Erosion Control at Hazardous Waste Sites," Report No. EPA/600/2-86/085, US Environmental Protection Agency, Cincinnati, Ohio, 1986.
- Ingold, T. S., "An Analytical Study of Geotextile Reinforced Embankments," *Proceedings of the 2nd International Conference on Geotextiles*, Las Vegas, Aug 1-6, Vol. 3, pp. 683-688, 1982.
- Instruction for Use of Construction Specification No. 210, "Plastic Filter Cloth," Department of the Army Corps of Engineers, Office of the Chief of Engineers, Washington, DC, 1981.
- Jewell, R. A., "A Limit Equilibrium Design Method for Reinforced Embankments of Soft Foundations," *Proceedings of the 2nd International Conference on Geotextiles*, Las Vegas, Aug 1-6, Vol. 3, pp. 671-676, 1982.
- Jones, C. J. F. P., *Earth Reinforcement and Soil Structures*, Butterworth and Co., Ltd., London, 1985.
- Keown, M. P., and Oswalt, N. R., "US Army Corps of Engineers Experience with Filter Fabric for Streambank Protection Applications, Flexible Armored Revetments Incorporating Geotextiles," *Proceedings of the International Conference Organized by the Institution of Civil Engineers*, London, 1984.
- Koerner, R. M., *Designing with Geosynthetics*, Prentice-Hall, Englewood Cliffs, N.J., 1986.
- Koerner, R. M., and Bove, J. A., "In-Plane Hydraulic Properties of Geotextiles," *Geotechnical Testing Journal*, Vol. 6, No. 4, pp. 190-195, 1983.
- Koerner, R. M., and Welsh, J. P., *Construction and Geotechnical Engineering Using Synthetic Fabrics*, Wiley, New York, 1980.
- Lamb, T. W., and Whitman, R. V., *Soil Mechanics, SI Version*, Wiley, New York, 1979.
- Lee, K. L., Adams, B. D., and Vagneron, J-M. J., "Reinforced Earth Retaining Walls," *Journal of the Soil Mechanics and Foundations Division, American Society of Civil Engineers*, Vol. 99, No. SM10, pp. 745-764, 1973.
- Leshchinsky, D., "Geotextile Reinforced Earth, Part I & II," Research Report Nos. CE 84-44/45, Department of Civil Engineering, University of Delaware, Newark, Del., 1984.
- Leshchinsky, D., Baker, R., and Silver, M. L., "Three Dimensional Analysis of Slope Stability," *International Journal for Numerical and Analytical Methods in Geomechanics*, Vol. 9, pp. 199-223, 1985.
- Leshchinsky, D., and Boedeker, R. H., "Geosynthetic Reinforced Soil Structures," *Journal of the Geotechnical Engineering*, American Society of Civil Engineers, Vol. 115, No. 10, pp. 1459-1478, 1989.
- Leshchinsky, D., and Field, D. A., "In-Soil Load Elongation, Tensile Strength and Interface Friction of Nonwoven Geotextiles," *Proceedings of the Geosynthetics '87 Conference*, New Orleans, Feb 24-25, Vol. 1, pp. 238-249, 1987.
- Leshchinsky, D., and Perry, E. B., "On the Design of Geosynthetic-Reinforced Walls," *Geotextiles and Geomembranes*, (in press), 1989.
- Leshchinsky, D., and Reinschmidt, A. J., "Stability of Membrane Reinforced Slopes," *Journal of the Geotechnical Engineering, American Society of Civil Engineers*, Vol. 111, No. 11, pp. 1285-1300, 1985.
- Leshchinsky, D., and Volk, J. C., "Stability Charts for Geotextile Reinforced Walls," *Transportation Research Record*, 1031, pp. 5-16, 1985.
- McGhee, K. H., "Efforts to Reduce Reflective Cracking of Bituminous Concrete Overlays of Portland Cement Concrete Pavements," Virginia Highway and Transportation Research Council, Charlottesville, Va., 1975.
- McGowan, A., Andrawes, K. Z., and Kabir, M. H., "Load-Extension Testing of Geotextiles Confined In-Soil," *Proceedings of the 2nd International Conference on Geotextiles*, Las Vegas, Aug 1-6, Vol. 3, pp. 793-798, 1982.
- Meyerhof, G. G., "The Bearing Capacity of Foundations Under Eccentric and Inclined Loads," *Proceedings, 34th International Conference on Soil Mechanics and Foundation Engineering*, Zurich, Vol. 1, pp. 440-445, 1953.
- Mitchell, J. K., "Earth Walls," *Transportation News*, Transportation Research Board, National Research Council, No. 114, pp. 24-31, 1984.

- Mohney, J., "Fabric Retaining Wall-Olympic N. F.," *Highway Focus*, Vol. 9, No. 1, pp. 88-103, 1977.
- Murray, R. T., "Fabric Reinforced Earth Walls: Development of Design Equations," *Ground Engineering*, Vol. 13, No. 7, pp. 29-36, 1980.
- Murray, R. T., "Fabric Reinforced Earth Walls: Development of Design Equations," Supplementary Report 496, Structures Department, Transport and Road Research Laboratory, Crowthorne, Berkshire, United Kingdom, 1981.
- Murray, R., "Fabric Reinforcement of Embankments and Cuttings," *Proceedings of the 2nd International Conference on Geotextiles*, Las Vegas, Aug 1-6, Vol. 3, pp. 707-713, 1982.
- Perloff, W. H., *Pressure Distribution and Settlement*, Chapter 4 in *Foundation Engineering Handbook*, ed. by Winterkorn and Fang, Van Nostrand Reinhold Company, New York, 1975.
- Perloff, W. H., and Baron, W., *Soil Mechanics: Principles and Applications*, Wiley, 1976.
- Proceedings, International Conference on the Use of Fabrics in Geotechnics*, Ecole Nationale des Ponts et Chaussees, Paris, 3 Vol., 1977.
- Proceedings of the First Canadian Symposium on Geotextiles* (Calgary, Canada, Sep 1980), published by the Canadian Geotechnical Society, 700 EIC Bldg, 2050 Mansfield St., Montreal, Quebec, Canada, 1980.
- Proceedings, Second International Conference on Geotextiles*, Industrial Fabrics Association International, St. Paul, Minn., 4 Vol., 1982.
- Rankilor, P. R., *Membranes in Ground Engineering*, Wiley, Chichester, United Kingdom, 1981.
- Raymond, G. P., "Installation Factors that Affect Performance of Railroad Geotextiles," *Transportation Research Record 1071*, Transportation Research Board, Washington, DC, 1986.
- Richards, D. L., and Middleton, L. M., "Best Management Practices for Erosion and Sediment Control," Federal Highway Administration, Arlington, Va., 1978.
- Risseeuw, Ir. P., "Stabilenka Woven Reinforcement Fabric in Raising Mounds on Soft Soil," Report No. R.O. 5300.005, Akzo Research Laboratories, Department, C.T.I., Arnhem, The Netherlands, 1977.
- Rowe, R. K., "Reinforced Embankments: Analysis and Design," *Journal of the Geotechnical Engineering, American Society of Civil Engineers*, Vol. 110, No. 2, pp. 231-246, 1984.
- Sherard, J. L., "Sinkholes in Dams of Coarse, Broadly Graded Soils," *Thirteenth Conference of the International Congress on Large Dams, New Delhi, India*, Vol. 2, pp. 25-35, 1979.
- Shoop, S. A. and K. Henry, "The Effect of a Geotextile on Water Migration and Frost Heave in Large-Scale Tests," preprint 910532, Transportation Research Board, 70th Annual Meeting, January 13-17, 1991.
- Spangler, M. G., *Soil Engineering*, International Textbook Company, New York, 1951.
- Stilley, A. N., "A Model Study of Fabric Reinforced Earth Walls," thesis submitted in partial fulfillment of the requirements for the Degree of Master of Science to Oregon State University, Corvallis, Oreg., 64 pp., 1974.
- Terzaghi, K., and Peck, R. B., *Soil Mechanics in Engineering Practice*, 2nd Ed., Wiley, New York, 1967.
- US Department of Transportation, "Sample Specifications for Engineering Fabrics," FHWA Report TS-78-211, Federal Highway Administration, Washington, DC, 1978.
- Van Zanten, R. V., *Geotextiles and Geomembranes in Civil Engineering*, A. A. Balkema, Rotterdam, The Netherlands, 1986.
- Volk, J. C., "Analysis and Design of Geotextile Reinforced Walls," thesis submitted in partial fulfillment of the requirements for the Degree of Master of Civil Engineering to the Faculty of the University of Delaware, Newark, Del., 1984.
- Weimar, R. D., Jr., "Mechanism of the Geotextile Performance in Soil-Fabric Systems for Drainage and Erosion Control," *Transportation Research Record No. 916*, pp. 37-40, Transportation Research Board, 1983.
- Winterkorn, H. F., and Fang, H-Y, *Foundation Engineering Handbook*, Van Nostrand Reinhold Company, New York, 1975.
- Wyant, David C., "Evaluation of Filter Fabrics for Use as Silt Fences," Report No. VHTRC 80-R49, Virginia Highway and Transportation Research Council, Charlottesville, Va., 1980.

The proponent agency of this publication is the Office of the Chief of Engineers, United States Army. Users are invited to send comments and suggested improvements on DA Form 2028 (Recommended Changes to Publications and Blank Forms) to HQUSACE (CEMP-ET), WASH DC 20314-1000.

By Order of the Secretaries of the Army and the Air Force:

GORDON R. SULLIVAN
General, United States Army
Chief of Staff

Official:

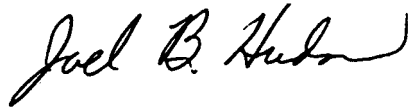

JOEL B. HUDSON
Acting Administrative Assistant to the
Secretary of the Army

OFFICIAL

JAMES E. McCarthy, *Maj General, USAR*
The Civil Engineer

Distribution:

Army: To be distributed in accordance with DA Form 12-34-E, block number 4578, requirements for TM 5-818-S.

Air Force: F