

---

United States  
Department of  
Agriculture

Natural  
Resources  
Conservation  
Service

---

**Part 631**  
**National Engineering Handbook**

---

**Chapter 32**

---

**Well Design and Spring  
Development**

Issued January 2010

The U.S. Department of Agriculture (USDA) prohibits discrimination in all its programs and activities on the basis of race, color, national origin, age, disability, and where applicable, sex, marital status, familial status, parental status, religion, sexual orientation, genetic information, political beliefs, reprisal, or because all or a part of an individual's income is derived from any public assistance program. (Not all prohibited bases apply to all programs.) Persons with disabilities who require alternative means for communication of program information (Braille, large print, audiotape, etc.) should contact USDA's TARGET Center at (202) 720-2600 (voice and TDD). To file a complaint of discrimination, write to USDA, Director, Office of Civil Rights, 1400 Independence Avenue, SW., Washington, DC 20250-9410, or call (800) 795-3272 (voice) or (202) 720-6382 (TDD). USDA is an equal opportunity provider and employer.

---

# Preface

---

The NRCS National Engineering Handbook (NEH), Part 631.32, Well Design and Spring Development, is derived from the following publications:

- NEH Section 18, Ground Water, released by SCS, April 1968
- NEH, Part 631, Chapter 33, Investigations for Ground Water Resources Development, released by the NRCS, November 1998

Note the following changes (the canceled documents are replaced by the new documents):

## **Canceled documents**

- NEH, Section 18, Ground Water (June 1978)
- Technical Release No. 36, Ground-Water Recharge (June 1967)
- NEH, Part 631, Chapter 33, Investigations for Ground Water Resources Development (November, 1998)

## **New documents**

- National Engineering Handbook chapters in Part 631
  - 631.30, Groundwater Hydrology and Geology
  - 631.31, Groundwater Investigations
  - 631.32, Well Design and Spring Development
  - 631.33, Groundwater Recharge



---

<b>Contents</b>	<b>631.3200</b>	<b>Water well design</b>	<b>32-1</b>
		(a) Introduction .....	32-1
		(b) Livestock and domestic wells.....	32-1
		(c) Methods of drilling wells.....	32-1
		(d) Other methods .....	32-5
		(e) Well logs.....	32-5
		(f) Correlation and interpretation.....	32-10
		(g) Well design .....	32-12
		(h) Well casing.....	32-12
		(i) Well screen design.....	32-21
		(j) Well development.....	32-31
		(k) Pumping tests .....	32-37
		(l) Maintenance.....	32-37
	<b>631.3201</b>	<b>Spring development</b>	<b>32-40</b>
		(a) Classification of springs .....	32-40
		(b) Development of springs.....	32-40
	<b>631.3202</b>	<b>References</b>	<b>32-55</b>

---

---

**Tables**

<b>Table 32-1</b>	Water well constructions methods	32-2
<b>Table 32-2</b>	Capacity of cylinders	32-4
<b>Table 32-3</b>	AWWA casing thickness	32-13
<b>Table 32-4</b>	Relation of changing diameter to yield of wells	32-14
<b>Table 32-5</b>	Differential head limitations for steel casings	32-16
<b>Table 32-6</b>	Maximum allowable differential head for selected plastic pipe	32-19
<b>Table 32-7</b>	Dimension and differential head limitations for selected PVC-12454 plastic pipe, schedules 40 and 80	32-20
<b>Table 32-8</b>	Dimension and differential head limitations for reinforced plastic (RPMP)	32-20
<b>Table 32-9</b>	Characteristics of depression springs	32-41
<b>Table 32-10</b>	Characteristics of contact springs	32-42
<b>Table 32-11</b>	Characteristics of fracture, joint, and tubular springs	32-43
<b>Table 32-12</b>	Characteristics of aquifer outcrop springs	32-45
<b>Table 32-13</b>	Characteristics of fault springs	32-46
<b>Table 32-14</b>	Tunnel location	32-49
<b>Table 32-15</b>	Gallons of water lifted by hydraulic ram per gallon received from source	32-53

**Figures**

<b>Figure 32-1</b>	Reverse circulation drilling	32-3
<b>Figure 32-2</b>	Cutting sample box	32-6
<b>Figure 32-3</b>	Sample catching system	32-7
<b>Figure 32-4</b>	Generalized SP logging arrangement	32-8
<b>Figure 32-5</b>	Resistivity electrode arrangement	32-9
<b>Figure 32-6</b>	Relative natural gamma radiation of rocks	32-10
<b>Figure 32-7</b>	Examples of well logs	32-11
<b>Figure 32-8</b>	Full and partial penetration of wells	32-13
<b>Figure 32-9</b>	Relation of drawdown to yield	32-13
<b>Figure 32-10</b>	Maximum allowable differential head for steel pipe	32-17
<b>Figure 32-11</b>	Maximum allowable differential head for plastic pipe	32-21
<b>Figure 32-12</b>	Grain size distribution for a sand aquifer	32-24
<b>Figure 32-13</b>	Grain size distribution for a sand and gravel aquifer	32-25
<b>Figure 32-14</b>	Artificial filter pack design for a sand aquifer	32-27
<b>Figure 32-15</b>	Artificial filter pack design for a sand aquifer, example 2	32-28
<b>Figure 32-16</b>	Surge blocks	32-32
<b>Figure 32-17</b>	Development with air or dry ice	32-35
<b>Figure 32-18</b>	Depression spring, seepage, or filtration type	32-41
<b>Figure 32-19</b>	Typical contact springs	32-42
<b>Figure 32-20</b>	Spring in joint sandstone	32-43
<b>Figure 32-21</b>	Spring in jointed basalt	32-43
<b>Figure 32-22</b>	Spring in jointed limestone	32-44
<b>Figure 32-23</b>	Artesian spring at outcrop of aquifer	32-45
<b>Figure 32-24</b>	Artesian spring occurring along a fault	32-46

---

<b>Figure 32-25</b>	Spring collection system	32-46
<b>Figure 32-26</b>	Spring box and pipe arrangement	32-48
<b>Figure 32-27</b>	Hydraulic ram	32-52
<b>Figure 32-28</b>	Spring development in stream channel	32-54

---



## 631.3200 Water well design

### (a) Introduction

A well, as used herein, is a vertically drilled or dug hole in the ground constructed for the purpose of obtaining water from the material which it penetrates.

An efficient well is designed and constructed utilizing sound geological and engineering principles. Some of these principles, such as methods of drilling and logging wells, screen and filter pack design, casing design, development of wells, and maintenance, will be described in this chapter. NRCS National Conservation Practice Standard, Water Well (642), provides minimum criteria for use, design, and installation of water wells.

### (b) Livestock and domestic wells

The criteria described in this chapter pertains mainly to high-yielding irrigation wells. Much of these criteria are also applicable to livestock and domestic wells where the required yield is much less.

The criteria on selection of well screen openings, types of metal, entrance velocity, and well development are all valid for small wells.

When designing wells for livestock water or domestic use, the top of the screen should be far enough below the water table to allow for seasonable and long-term fluctuations of the water table. Screen a short interval of a coarse-grained zone in the aquifer in preference to a longer section of a fine-grained zone (see section 631.3200(i)(4.)) To increase the yield of a well, increase the length of the screen, not the diameter. Doubling the length will nearly double the yield, while doubling the well diameter will not increase the yield proportionally.

Always consider sanitary protection. All drainage should be away from the well. Locate the well up the hydraulic gradient from potential sources of contamination such as barns and septic fields. The casing should be grouted in place to prevent contaminated surface or groundwater from co-mingling with the water in the aquifer.

### (c) Methods of drilling wells

Wells may be drilled by one of five principal methods: rotary hydraulic, reverse hydraulic, percussion or cable tool, jetting, and boring. Each method has advantages over the other methods under certain conditions. Table 32-1 shows the various drilling methods and their application to subsurface conditions and water uses.

#### (1) Rotary hydraulic

The rotary hydraulic method of drilling wells is based on the principle of flushing cuttings out of the well with the aid of water. A local clay, bentonite, or gel is usually mixed with the water to make a slurry or drilling mud. The consistency of the drilling mud is varied by adding either barite, clay, or water, depending on the mud weight needed to stabilize the hole and the character of the material being penetrated. This mud is pumped under pressure through a hollow drill stem to the bottom of the hole where it is discharged through openings in the bit. The bit is designed to cut materials from the bottom of the hole as the drill stem and bit are rotated. The drill cuttings are carried to the surface in the annular space between the drill stem and wall of the hole by the drilling mud.

The cuttings settle out of the mud in pits before the mud is recirculated. Mud pressure and consistency must be adequate to maintain circulation in the system and carry drill cuttings out of the hole while drilling.

The hydraulic rotary method is effective for drilling most rocks. The hardest rock may be drilled with calyx-shot, carbide-tipped, and diamond bits.

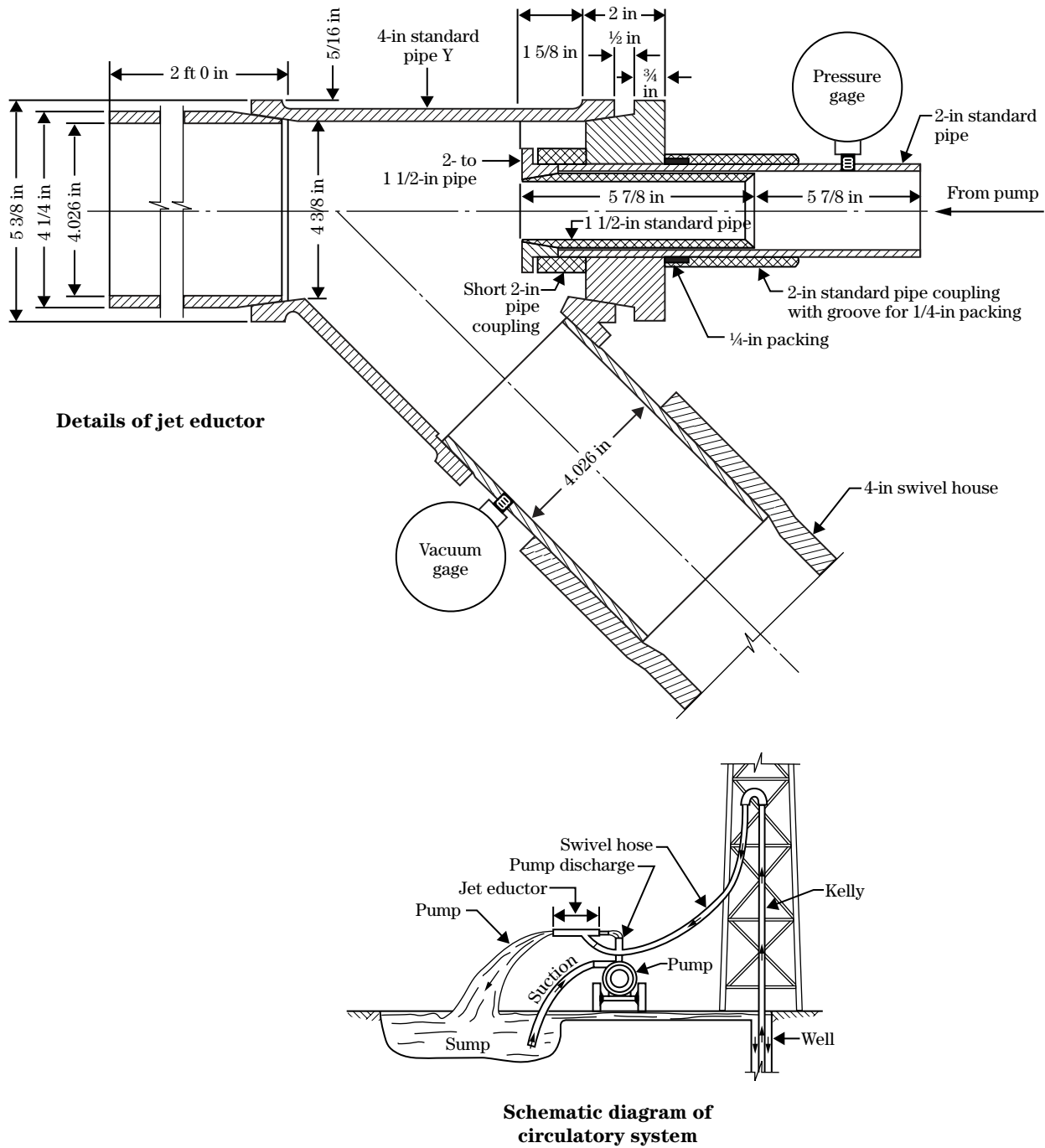
#### (2) Reverse hydraulic

The reverse hydraulic method is similar to the rotary hydraulic except the drilling fluid is circulated along the annulus of the bore-hole, exiting up through the drill string. It is best suited for drilling large-diameter wells, because reverse circulation maintains a high velocity in the water rising in the drill stem and efficiently removes cuttings. Water is used instead of drilling mud. The drill stem is larger and is connected with a suction pump instead of a pressure pump. Water and drill cuttings are removed from the drill stem by the suction pump and jet eductor (fig. 32-1), and discharged into pits. To avoid caving, it is important to keep the hole full of water.

**Table 32-1** Water well construction methods

Type	Method	Materials for which best suited	Water table depth for which best suited		Usual max. depth (ft)	Usual diameter		Customary use					Yield		Remarks
			Min. (ft)	Max. (ft)		Min. (in)		Domestic water supply	Livestock	Municipal and industrial	Irrigation	Drainage	Min. (gal/min)	Max. (gal/min)	
Dug well	Hand	Clay, silt, sand, gravel	5	30	50	3	8	X	X				3	20	Surface seal necessary. Foundation problems.
	Machine	Clay, silt, sand, gravel	5	20	25	6	40			X	X		100	1,500	Foundation problems. Development not possible.
Driven well	Hand or air hammer	Silt, sand, gravel <2 in	5	15	50	1 3/4	4	X				X	3	40	Limited to shallow water table, no large gravel.
Jetted well	Light, portable rig	Silt, sand, gravel <1 in	5	15	50	1 3/4	24	X	X	X	X	X	3	3,000	Limited to shallow water table, no large gravel.
Drilled well	Cable tool	Unconsolidated and consolidated medium hard and hard rock	Any	Any	1,500	3	24	X	X	X	X	X	3	3,000	Effective for water exploration. Requires casing in loose materials. Mud-scow and hollow rod bits developed for drilling unconsolidated fine to medium sediments.
	Hydraulic rotary	Silt, sand, gravel <1 in; soft to hard consolidated rock	Any	Any	1,500	3	18	X	X	X	X	X	3	3,000	Fastest method for all but hardest rock. Casing is usually not required during drilling. Effective for gravel envelope wells.
	Reverse hydraulic rotary	Silt, sand, gravel, cobble	5	100	200	16	48			X	X		500	4,000	Effective for large diameter holes in unconsolidated and partially consolidated deposits. Requires large volumes of water for drilling. Effective for gravel envelope wells.
	Air rotary	Silt, sand, gravel <2 in; soft to hard consolidated rock.	Any	Any	2,000	12	20			X	X		500	3,000	Used in oil explorations. Very fast drilling. Combines rotary and percussion methods (air drilling). Cuttings removed by air. Economical for deep water wells.
Augering	Hand auger	Clay, silt, sand, gravel <2 in	5	30	35	2	8	X				X	3	50	Most effective for penetrating and removing clay. Limited by gravel over 1 in. Casing required if material is loose.
	Power auger	Clay, silt, sand, gravel <1 in	5	50	75	6	36	X			X	X	3	100	Limited by gravel over 2 in.

**Figure 32-1** Reverse circulation drilling



**(3) Cable tool**

The cable tool, percussion, or standard method of drilling is based on the principle of applying sufficient energy to pulverize the soil or rock by percussion. The energy applied is varied by controlling the length of the stroke and the weight of the drill stem and bit. Bits vary in diameter from a few inches up to 2 feet depending on the desired depth and diameter of the well. Bits and drill stems vary in length depending on the weight needed to furnish the desired impact. The bits need not be very sharp, but the drill end must be kept considerably larger than the shank to allow free movement of the bit in the hole. The bit is connected to a cable, and it is raised and released by means of a rocker arm on the drill rig to exert its energy on the bottom of the hole. To remove the drill cuttings, water is introduced to make mud that can be removed by means of a bailer.

The cable tool method must rely on casing when the hole begins to cave. The hole often caves when the drill enters or passes through a noncohesive water-bearing stratum. The casing will usually settle by its own weight for a short distance before it becomes necessary to drive it to penetrate the water-bearing stratum.

This method of drilling is designed primarily for hard rock and cobbly or bouldery materials. It tends to compact the unconsolidated sediments so that the walls of the hole become dense and tight.

**(4) Jetting**

The jetting method of drilling wells is usually used in sandy formations where water is developed by entry from the bottom of the casing. Perforated casing is not used. The casing, usually a 2-inch-diameter galvanized or black iron pipe, is used to drill the hole. Jagged edges are cut into the lower end for chopping purposes. The drill stem is lifted and dropped in the operation, and water is forced under pressure through the drill stem to remove cuttings. When the drill pipe has entered the zone of saturation far enough to have several feet of water in the casing, it is then considered to be in proper place, and jetting is terminated. A cylinder is then lowered into the well with sand point or screen on the lower end of the tail pipe to complete the installation. This method is never used for test drilling that requires collection of representative samples.

**(5) Boring**

The boring method of well drilling is based on the principle of the Iwan auger. It is designed for unconsolidated sediments and is successfully used where water-bearing formations are very fine textured and permeabilities are low. The auger is connected to a shaft that is rotated slowly. It is designed to retain drill cuttings and pulled out of the hole to empty the bucket. Diameters may vary from 12 to about 36 inches.

These wells can be bored up to depths of 100 to 150 feet if rock or caving soils are not encountered. They have the advantage of developing reservoir capacity within the dug space where water-bearing formations release water at a relatively slow rate. The volume of water in a cylinder 12 inches long is given by the following formulas (table 32-2):

$$\text{Gallons} = 0.0408 d^2 \text{ with } d \text{ in inches}$$

or

$$\text{Gallons} = 5.8752 d^2 \text{ with } d \text{ in feet}$$

**Table 32-2** Capacity of cylinders

Diameter in inches	Gallons/lineal foot	Diameter in feet	Gallons/lineal foot
2	0.16	2	24
4	0.65	3	53
6	1.5	4	94
8	2.6	5	147
10	4.1	6	212
12	6.0	7	288
		8	376
		9	477
		10	590
		12	846
		15	1,278
		20	2,350
		25	3,671

## (d) Other methods

Dug wells are best suited to shallow water tables and where thickness of the water-bearing material is not great. Construction can be difficult due to caving, and any opportunity to improve their yield by development is lost due to the inherent sealing caused by the digging process. Dug wells are also very susceptible to contamination from surface or near-surface run-in.

Wells constructed by driving are limited to areas underlain by unconsolidated clay, silt, and sand that are relatively free of gravel, cobbles, or boulders. Depth to water, including drawdown, must be less than the suction limit at the elevation of the well. The practical limit of suction lift for pumps is 22 feet at sea level, 17 feet at 5,000-foot elevation, and 14 feet at 10,000-foot elevation.

Driven wells are constructed by driving pipe fitted with a sand point sufficiently below the water table so that fluctuations and drawdown from pumping will not lower water below the point.

A sand point consists of a forged steel point attached to a short length of perforated pipe. The perforated pipe is wrapped with either brass screen or spiral wound brass bands having a trapezoidal cross section. The bands form a relatively nonclogging slot that is narrowest at the outside.

In driving the point through materials containing considerable amounts of clay, the openings often become clogged. It may prove advisable to auger or jet the hole through the clay layers.

## (e) Well logs

Existing logs on completed or exploratory (or failed) wells can be important sources of information when siting or designing a new well. Caution must be used, however, because the quality and completeness of well logs vary.

### (1) Logs of samples

Good representative samples are necessary for the preparation of an accurate sample log and are required for proper design of well screen and filter pack. Samples should be collected for at least each 5-foot

interval of hole drilled and at every change in earth material encountered.

Rotary hydraulic samples are subject to some contamination by caving and recirculation of material in the drilling mud. With proper construction and location of the mud pits, recirculation of material can be minimized. Proper mud consistency can keep caving at a minimum. A sample box, as shown in figure 32-2, placed between the well and the mud pit, is a satisfactory method for obtaining representative samples.

When drilling in the aquifer, penetration of the bit should be stopped every 5 feet and the mud circulated until all cuttings are removed from the hole. The sample is then removed from the sample box and the box washed clean before another increment of 5 feet is drilled.

Undisturbed core samples are best. Push tube or drive samplers also provide excellent samples.

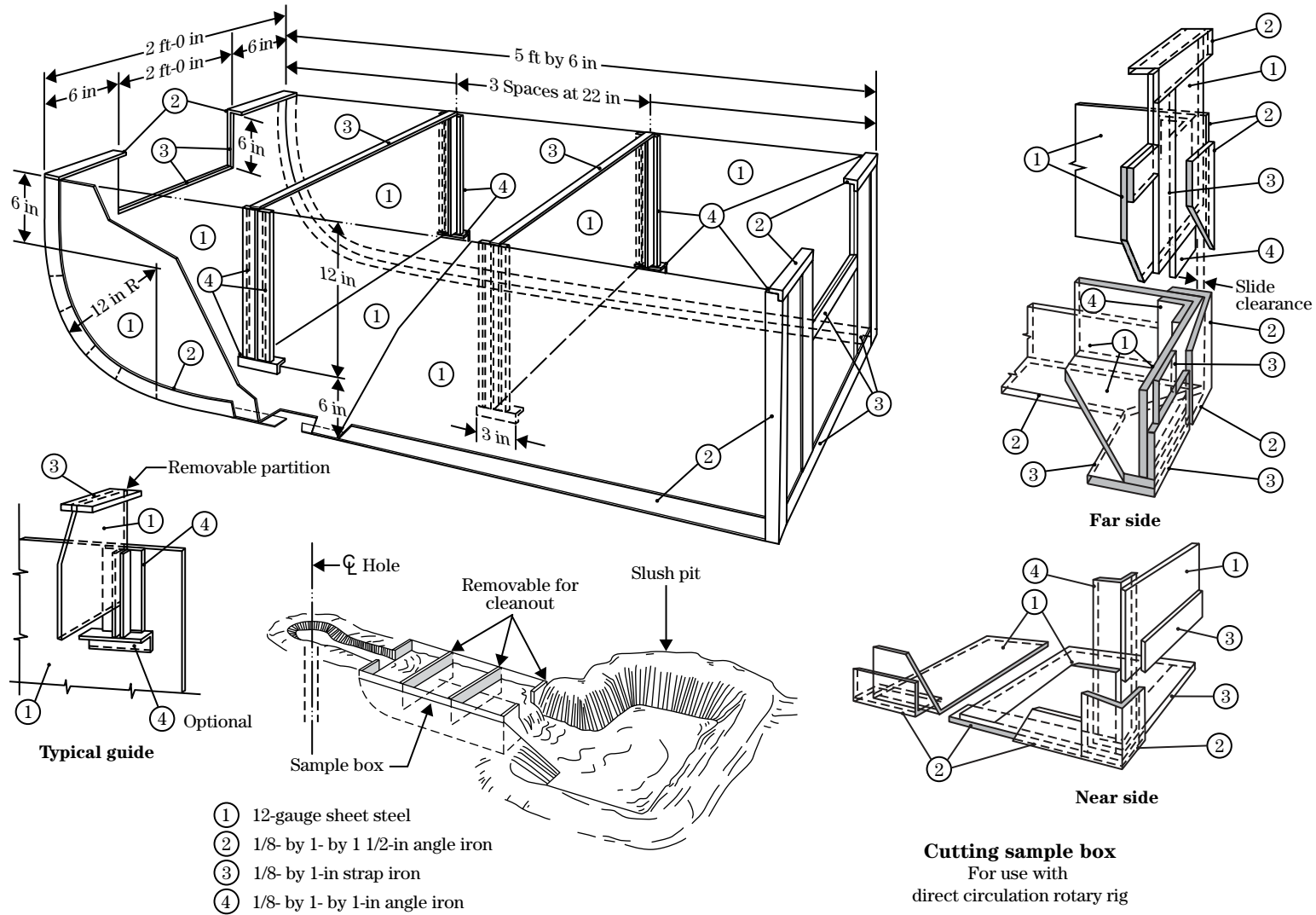
When reverse circulation rotary hydraulic drilling is used, the high velocity of the drilling fluid, for practical purposes, eliminates sample lag time, and the samples are contaminated very little from caving. The large volume of drilling fluid used in this method makes the sample box used in the standard rotary method impractical. Diverting part of the return flow into the sample box may be adequate, or the sample catching system shown in figure 32-3 can be used.

The quality or representativeness of samples from wells drilled by cable tool can be variable. In unconsolidated formations, if the casing follows closely behind the bit, the samples are usually good, and if the casing is bailed down, samples are excellent. All the cuttings from the sampling interval should be collected and then split to obtain the sample to be retained for testing and analysis.

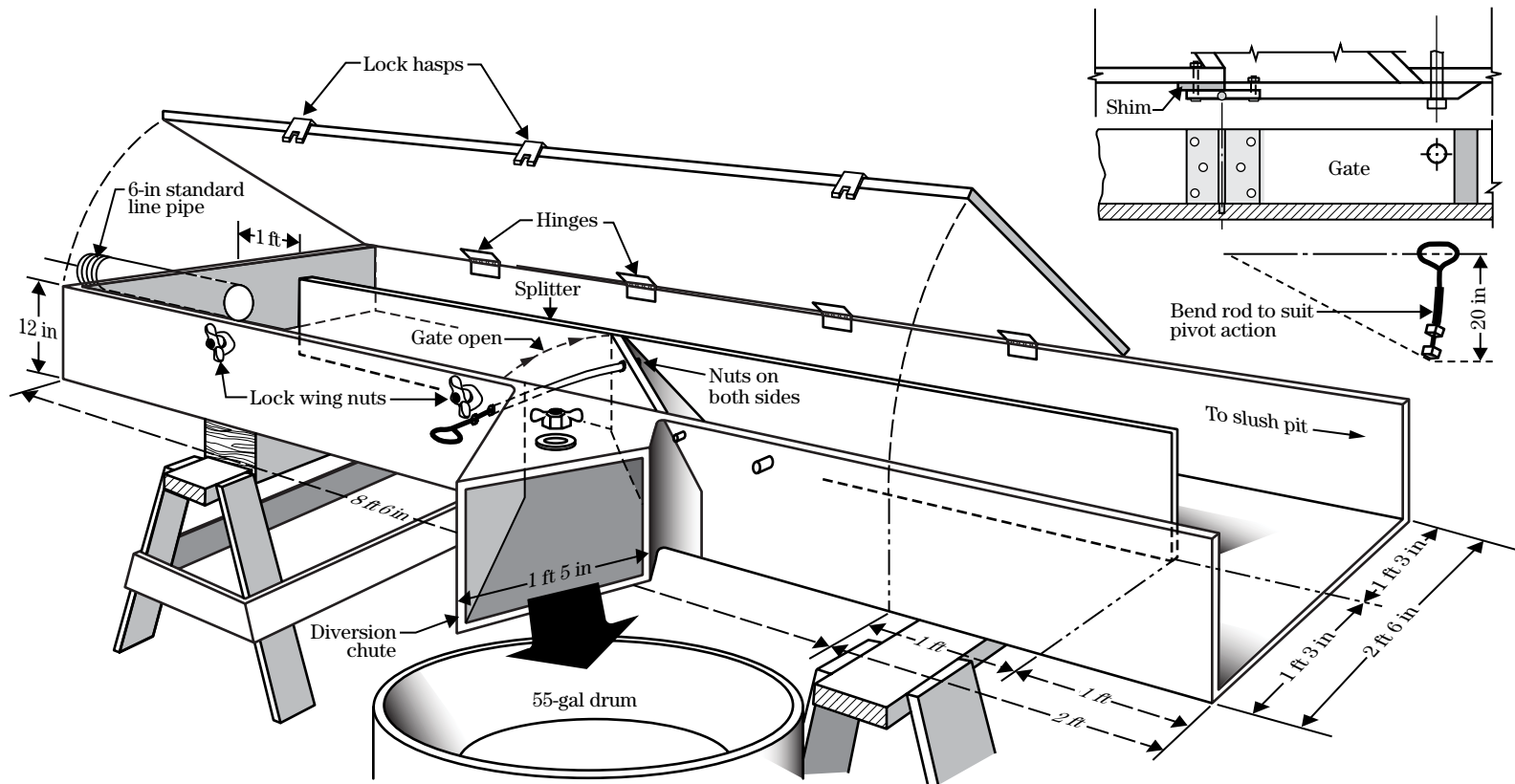
Samples are inadequate or not available from wells that are jetted or driven. Bored or dug wells are usually very shallow, but yield adequate samples.

Collected samples are described for mineral composition, grain size, Unified Soil Classification System (USCS) classification, color, and any other feature that can be seen. Mechanical analysis of the aquifer samples is necessary for screen slot and filter pack design. The descriptive information is plotted on a strip

**Figure 32-2** Cutting sample box (from U.S. Bureau of Reclamation, 1964)



(210-VI-NEH, Amend. 34, January 2010)

**Figure 32-3** Sample catching system (from U.S. Bureau of Reclamation, 1964)**Cope reverse circulation formation sampler**

Original model was made of welded 3/16-inch steel plate, but if general measurements are followed, model could be made from wood.

Discharge hose from reverse circulation pump is connected to 6-inch pipe so all materials go through sampler. Materials can be observed in open 2-foot discharge without cover.

Sampler is mounted on heavy horses or similar supports with about a 6-inch slope towards the slush pit into which material is discharged.

To obtain sample, control gate is thrown open against splitter to divert sample through chute and into 55-gallon oil drum.

log. To aid in correlation and comparison, the vertical scale should be the same as the scale of any other logs to be run on the well and the same as other wells in the vicinity.

### (2) Drilling time logs

The drilling time log is an aid in correlating other logs. Slow drilling time may indicate a hard or indurated zone. Fast, smooth drilling could indicate fine sands, and vibration of the drill stem could indicate sand and gravel.

### (3) Electric logs

The two types of electric logs generally used in groundwater investigations are the spontaneous potential logs (SP) and resistivity logs. These electric logs can only be run in bore holes filled with drilling fluid.

#### (i) Spontaneous potential logs

The SP is a quantitative tool and is the measure of the spontaneous electromotive force generated between the drilling mud and the fluid in the earth materials penetrated by the well.

The SP is measured by an electrode suspended in the well bore and another electrode at the ground surface. The amplitude of the SP curve is a function of several factors such as the resistivity of the mud and groundwater, hole diameter, and bed thickness. Figure 32-4 is an SP logging arrangement.

In general, when the resistivity of the drilling mud is higher than the formation fluid, the SP is negative. When the resistivity of the formation fluid and drilling mud are equal, the SP is very small or zero. When the resistivity of the drilling mud is lower than the formation fluid, the SP is positive.

With freshwater drilling mud, the SP in a freshwater aquifer is very small. The SP in an aquifer containing highly mineralized water is high and negative. Increasing clay content in an alluvial aquifer also gives a negative SP reading. Correlation with a good sample log aids in interpretation.

#### (ii) Resistivity logs

The resistivity log differs from the SP in that an induced current is used. Commonly, two current electrodes and two potential electrodes are used. The arrangement and spacing of the electrodes determine

whether the type of curve obtained is normal or lateral.

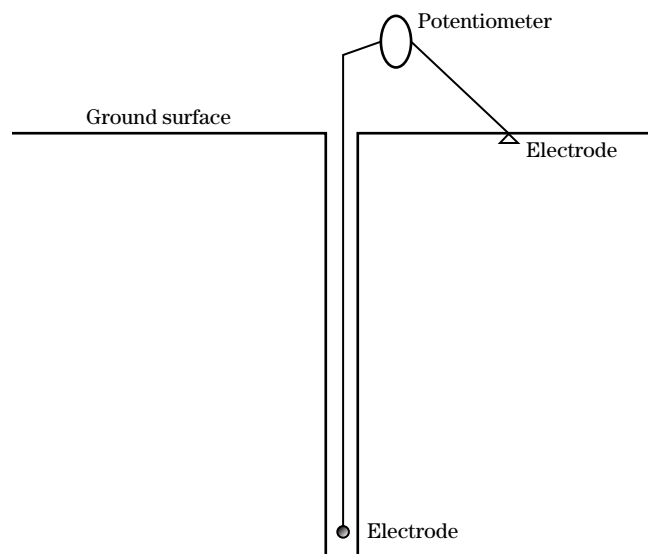
Figure 32-5 shows the electrode arrangement for normal and lateral types of resistivity logs.

In the normal curve, the distance between one potential electrode and one current electrode (AM) is the significant interval. The position of the current electrode B is not important, as long as it is large compared to AM.

In the lateral curve, the interval AO is the distance between one potential electrode and a point midway between the two current electrodes and is the significant interval. The interval AB must be small compared to AM. The resistivity log can be used to determine the boundaries between beds or zones of differential resistance. A sand or gravel containing fresh or only slightly mineralized groundwater has a much higher resistance than clay or shale where the interstitial water is highly mineralized with dissolved salts from the clay particles.

The normal resistivity log is usually run with at least two electrode spacings. Resistive beds thicker than the electrode spacing record a deflection in a positive (higher resistance) direction. Resistive beds thinner

**Figure 32-4** Generalized SP logging arrangement





than the electrode spacing give a negative deflection. Beds of the same thickness as the electrode spacing show no deflection.

The lateral resistivity curve shows resistive beds of all thickness. The upper boundary is indefinite for beds with a thickness greater than the AO interval, and true resistivity values are masked for a distance equal to the AO spacing. The thickness of beds less than the AB interval is exaggerated by an amount equal to the AB interval.

#### (4) Geophysical methods

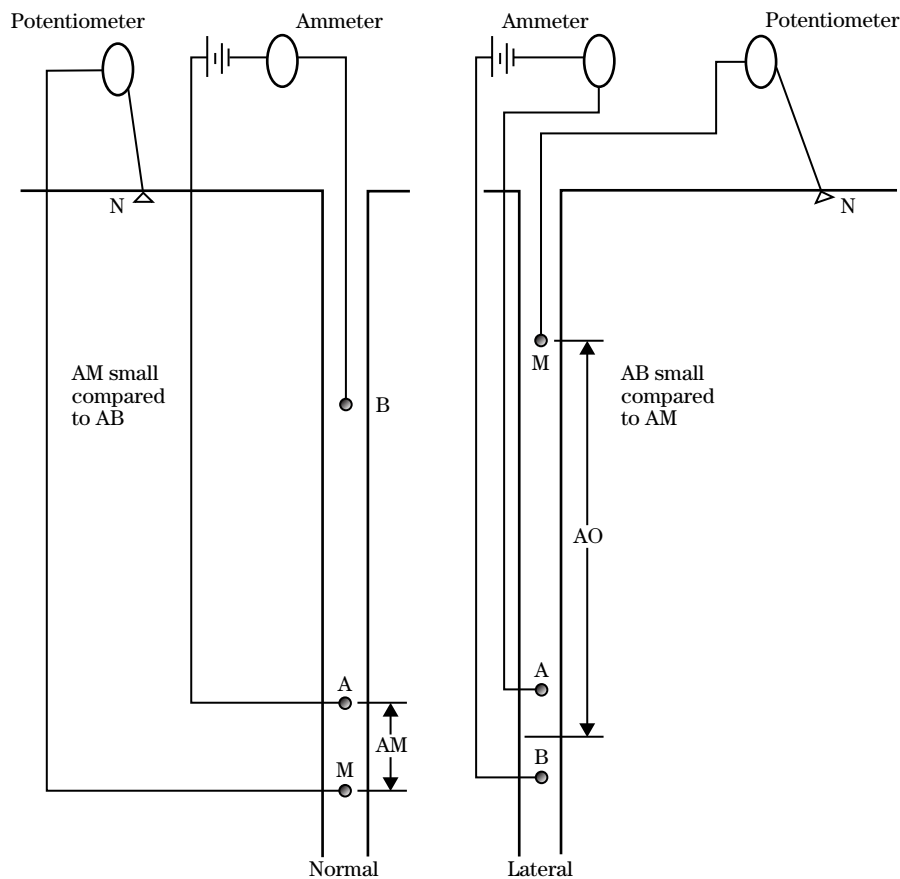
See NEH631.31 for additional information on the application of geophysical investigation methods, including ground penetrating radar, electrical conductivity, magnetometers, seismic refraction, and metal detectors.

#### (5) Radioactive logs

##### *Gamma ray logs*

Gamma ray logging measures the amount of natural gamma radiation of the material penetrated by a well. It is recorded by lowering a detecting instrument (a

**Figure 32-5** Resistivity electrode arrangement



Geiger Müller counter or scintillation counter) into the well and recording the readings at the surface. Natural gamma radiation is higher in shales and clays than in sands and gravels. Figure 32–6 indicates the natural gamma radiation of various types of formations.

#### *Neutron logs*

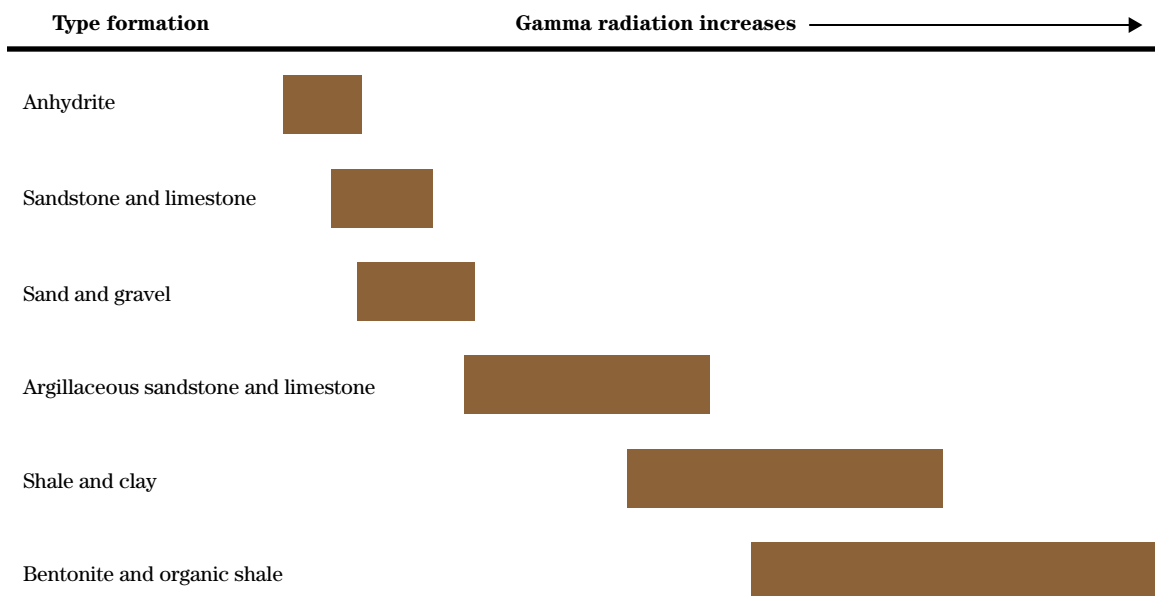
Neutron logging the formation is bombarded by a strong source of fast-moving neutrons. The secondary gamma rays that have been excited by the bombardment are recorded on the log. Hydrogen is the controlling factor in neutron logging. When hydrogen is present, the neutrons are slowed down or stopped, giving a low value on the curve. The activity recorded on the log is inversely proportional to the hydrogen present. Since groundwater is the source of most large quantities of hydrogen, a low value on the log would indicate a water-bearing zone. Conversely, a high value on the log would indicate no water and, therefore, dense or nonporous rocks. Correlation with other logs is necessary because shale or clay could contain water, giving a low value on the log, but they are not usually aquifers.

### (f) Correlation and interpretation

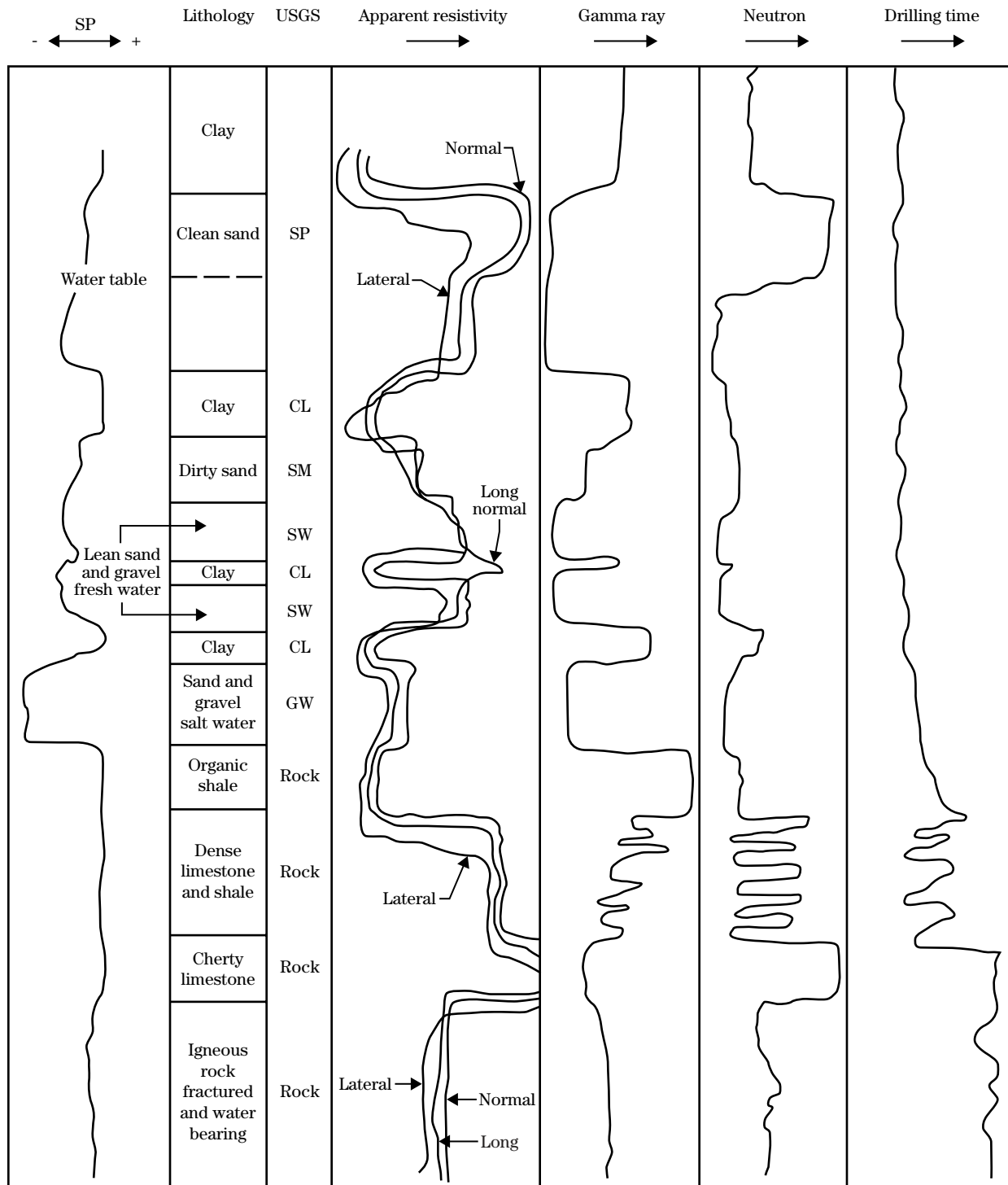
Correlation and interpretation of the various types of well logs provide excellent information for well design. Correlation of logs from a test well with logs from production wells with known aquifer characteristics permit rapid identification of the most favorable water-producing zones in the test well.

Interpretations of the different types of logs on the same well indicate formational changes and major differences in water quality. Figure 32–7 shows examples of the characteristic curves of the various types of logs run in a freshwater drilling mud. In this figure, the SP curve gives a positive deflection opposite clay beds, negative deflection opposite saltwater aquifers, and no deflection opposite freshwater aquifers. The resistivity curves show high resistance opposite freshwater alluvial aquifers and dense rock and low resistance opposite clay, shale, and saline aquifers.

**Figure 32–6** Relative natural gamma radiation of rocks



**Figure 32-7** Examples of well logs



The gamma ray and neutron logs are helpful in differentiating between permeable zones and clay beds. A low or negative deflection on both curves indicates a permeable water-bearing zone. A high or positive deflection of the gamma ray curve and a low or negative deflection of the neutron curve indicate clay or shale.

### (g) Well design

Many factors must be considered in the proper design of a well. The purpose of the well (livestock, irrigation, etc.) and the required yield determine the optimum size of the well. The potential for corrosion dictates the type of casing and screen that should be used and the method of installation. Mechanical analyses of aquifer samples guide the design of filter packs and well screens. The ultimate goal in well design and construction is to provide an efficient well to produce the required amount of water at the least cost.

#### (1) Drawdown and yield

The best design for a well that must produce at or near its maximum rate is one that fully penetrates the aquifer. The flow to the well is radial as shown in figure 32-8. In a partially penetrating well, the flow path is curvilinear, longer, and encounters more resistance than in radial flow. Wells A and C will produce the same amount of water with less drawdown than wells B and D.

When constructing a well in an artesian aquifer, the screen should extend through the full thickness of the aquifer, and the maximum drawdown should not be below the top of the screen, for optimum production.

For nonartesian aquifers, the lower one-third of the aquifer should be screened, and the drawdown should not be below the top of the screen for optimum production. Figure 32-9 shows that about 85 percent of the yield for nonartesian aquifers occurs at about 60 percent drawdown.

Exceptions to the full penetration of an aquifer are areas that may be affected by saltwater intrusion, including where saline water may lie beneath fresh groundwater. This is likely in coastal areas, on islands, and in arid areas where evaporite or brine deposits are common in the geologic section. In these areas, a study of geology and conditions under which ground-

water occurs should be made to determine the maximum depth of wells (Todd 1959).

Beneath coastal areas, movement of fresh groundwater toward the sea usually prevents landward intrusion of the slightly denser saltwater. Hydrostatic equilibrium is established between these fluids of different densities. For each foot of freshwater above sea level, there are about 40 feet of freshwater lying below sea level. The freshwater/saltwater interface slopes downward away from the ocean, as the water table rises. This is known as the Ghyben-Herzberg relation between fresh and saline waters and is a function of freshwater being slightly less dense, and therefore "floats" on saltwater.

As a general guide for use in planning, wells in proximity of the coast should not pump from below mean sea level. The anticipated drawdown of interior basin wells should bottom out above the freshwater/saltwater interface (interface may rise as much as 40 feet for each foot of drawdown). Wells should be designed and developed for minimum drawdown and located so that drawdown is distributed as widely as possible.

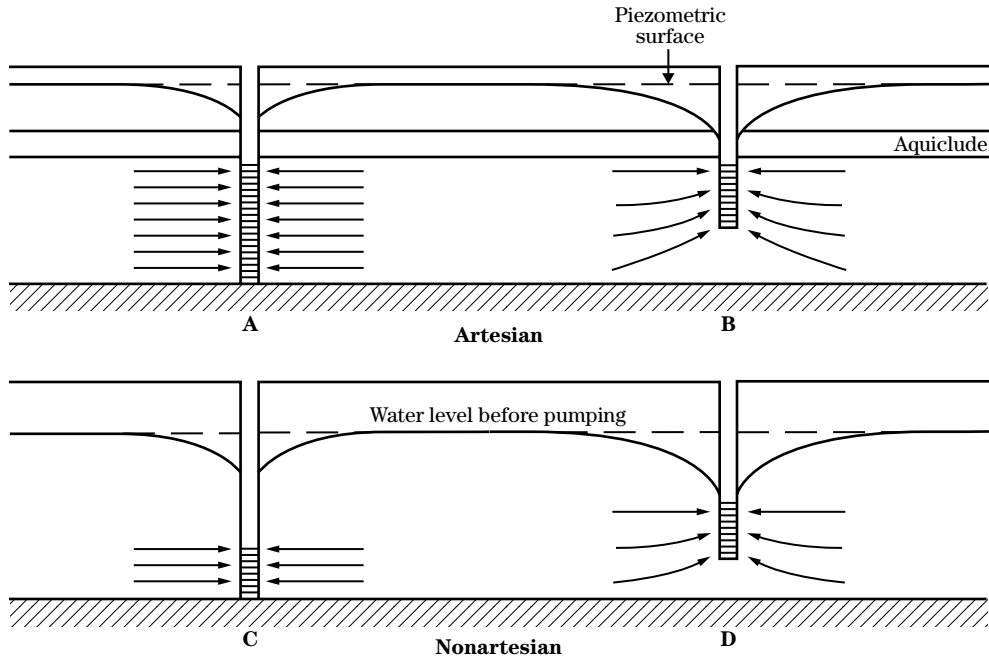
### (h) Well casing

Casing maintains the hole through loose, caving, or flowing materials and seals out contaminated or undesirable waters. Casing must be strong enough to resist earth pressure and, depending on method of placement, may have to withstand considerable shock and compressive stress. Casing should also be sufficiently resistant to corrosion to last 25 to 50 years. The selection and design of water well casing is a function of hydrostatic head, aquifer materials, and desired yields.

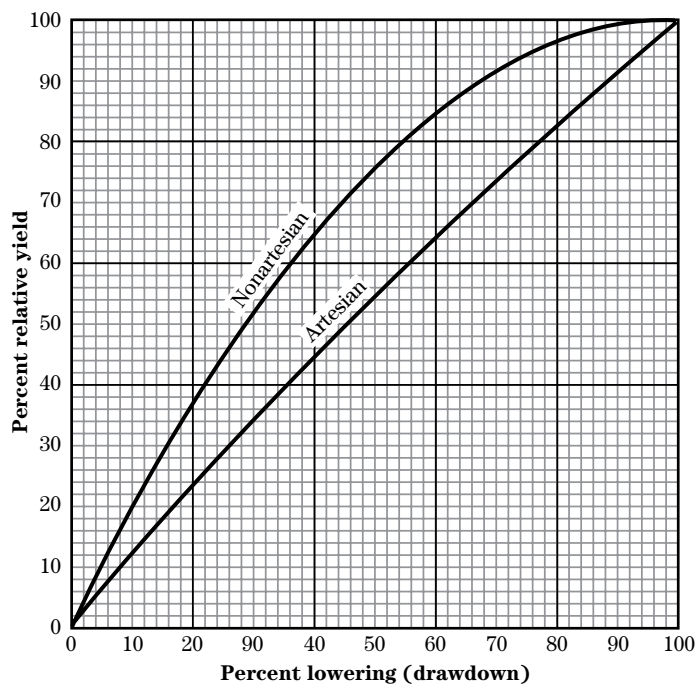
#### (1) Materials

Most wells are cased with steel or iron pipe, using welded or threaded and coupled joints. When casing is to be driven, a steel drive shoe is riveted or welded to the bottom of the pipe to ream the hole and prevent crimping of the casing. Casings of other materials and designs are used, with special drilling methods adapted to specific geologic conditions. The American Water Works Association (AWWA) (1998) recommends thickness of steel or iron casing considered best practice as shown in table 32-3.

**Figure 32-8** Full and partial penetration of wells



**Figure 32-9** Relation of drawdown to yield (from E.E. Johnson, Inc., The Yield of Water Wells, Bull. 1238 (Rev.), 1955)



**Table 32-3** AWWA casing thickness

Casing diameter (in)	Casing wall thickness (in)
6	0.280
10	0.365
12-20	0.375
22-36	0.500

“Stovepipe” or double casing is used in sediment-filled valleys in California and Arizona. It consists of telescoping sheet iron sections, 8 to 16 gauge in thickness, 2 to 4 feet in length, and 4 to 36 inches in diameter. This technique is for use with the mud-scow, orange peel bucket, and hollow rod drilling methods.

Copper and alloys high in copper corrode slowly in most soils, but corrode at their highest rate in soils containing sulfides. Aluminum and some of its alloys corrode rapidly under most soil conditions. Steel or iron pipe, while not corrosion resistant, has adequate life for use as well casing under most conditions. The use of heavy pipe is an economical means of obtaining long life even in fairly corrosive materials.

Under especially corrosive conditions, pipe and tubing of stainless steel, brass, and copper alloys containing manganese, nickel, and silicon have been used. The relative corrosion resistance of these metals is shown in section 631.3200(i), Well screen design. Joints are welded because the wall thickness is less than for steel or iron pipe. Plastic pipe may be used as casing according to American Society for Testing and Materials (ASTM) standards.

### (2) Size

Steel and iron pipe have standard dimensions, weight, and threads. Refer to current applicable standards published by the ASTM. Sizes 14 inches and over are

designated by outside diameter. Pipe 6 inches in diameter and smaller is referred to as “standard weight pipe.” Sizes more than 6 inches are called line pipe, and pipe 8 inches in diameter and more is made in more than one wall thickness. Heavier walls are needed for hard driving and corrosive environment.

### (3) Diameter and yield

The diameter of the well depends on the nature and thickness of the water-bearing material, the area of openings or perforations necessary to allow for water entrance velocity at about 0.10 feet per second, and the size of the pump required (Johnson 1975). Increasing the diameter of a well increases its yield, but not in direct proportion to the increase in diameter. In other words, doubling the diameter of a well increases, but does not double, its yield.

Table 32-4 shows the relationship between the increase in diameter to increase in yield for wells of the same depth in the same formation, all other things being equal.

If the well is to be pumped by a turbine pump, the diameter of the casing down to the lowest anticipated bowl setting should be at least 2 inches larger than the diameter of the pump bowls. This will allow water to

**Table 32-4** Relation of changing diameter to yield of wells

Well diameter—inches								
2 in	4 in	6 in	8 in	12 in	18 in	24 in	36 in	48 in
0	10	15	20	25	33	38	48	55
	0	5	10	15	23	28	38	45
		0	5	10	18	23	33	40
			0	5	13	18	28	35
				0	8	13	23	30
					0	5	15	22
						0	10	17
							0	7
								0
Percent increase in yield (read across only)								

flow past the bowls to the intake with minimum head loss and also allow for some deviation of the well from the vertical.

A submersible pump is one in which the pump and motor are an integral unit. The motor and pump are submerged below the expected drawdown in the well, and the motor is below the pump. Pump manufacturer recommendations must be followed for an efficient installation of a submersible pump.

#### (4) Installation

During the development of a well, fines are removed from the aquifer adjacent to the well bore. This tends to form a cavity near the top of the aquifer, which may result in the caving of the overlying material. If this happens, the casing could settle. To prevent this, it is desirable, where possible, to seat the casing on hard rock or stiff clay.

All or part of the casing should be grouted in place. The grout forms a seal between the casing and the disturbed formation. This prevents surface water from entering and possibly contaminating the well. The grout should also extend deep enough to seal off any undesirable water zones between the ground surface and the top of the aquifer to prevent co-mingling of undesirable water.

In a corrosive environment, a grout seal for the entire length of the casing will protect it from attack. Minimum grout thickness at any point should be about 1.5 inches.

Grout can be placed either through the casing or through the annular space outside the casing. The important points in placing grout are sufficient grout must be available to complete the job in one continuous operation, any temporary casing must be removed so that the grout is in intimate contact with the casing and formation, and the grout must be allowed to set up, usually about 72 hours, so that it is not damaged by vibration when drilling is resumed.

#### (5) Collapse pressure design

Maximum allowable collapse pressure of water well casing is based on collapse resistance, or the hydraulic pressure associated with the maximum anticipated differential head. The term "differential head" applies to the difference in water levels between the inside

and outside of the casing. For unconfined aquifers, maximum anticipated differential head is determined by subtracting the depth of maximum anticipated drawdown from the highest anticipated elevation of the water table. For confined aquifers, use the highest potentiometric surface.

##### (i) Steel well casing

Collapse resistance of steel casing is a function of diameter, wall thickness, and eccentricity (out-of-roundness). Eccentricity can originate from rough handling in transport or on the job site. Small eccentricity can result in significant loss of collapse resistance. Consider for example, a 6.625-inch (outside diameter) steel casing with a wall thickness of 0.25 inch. The design collapse pressure for a perfect cylinder (no eccentricity) is 3,826 pounds per square inch (8,838 ft). However, for values for eccentricities of 0.5, 1.0, and 1.5 percent, the design collapse pressures are reduced to 1,576 pounds per square inch (3,639 feet), 1,231 pounds per square inch (2,844 feet), and 1,024 pounds per square inch (2,365 feet), respectively. For this reason, collapse resistance for steel casing is calculated by the Timoshenko Elastic Formula, which has an adjustment for eccentricity.

Table 32-5 gives differential head limitations calculated for selected sizes of ASTM A-139 Grade B carbon steel casing by the Timoshenko Elastic Formula using:

Young's modulus of elasticity,

$$(E) = 3 \times 10^7 \text{ pounds per square inch}$$

Poisson's ratio,  $\mu = 0.30$

Casing eccentricity,  $(e) = 0.01$  (1%)

Yield strength = 35,000 pounds per square inch

Ultimate tensile strength = 60,000 minimum pounds per square inch

Values for head in table 32-1 are rounded down to the nearest 5 feet.

Design collapse pressure ( $P_d$ ) is the solution of the Timoshenko Elastic Formula:

$$P_d^2 - P_a \left\{ \frac{2Y_p}{(SDR - 1)} + P_{cr} [1 + 3e(SDR - 1)] \right\} + \frac{2Y_p P_{cr}}{SDR - 1} = 0 \quad (\text{eq. 32-1})$$

**Table 32-5** Differential head limitations for steel casings

		Nominal casing size (in)									
		4	5	6	8	10	12	14	16	18	24
		Outside diameter (in)									
Wall thickness (uncoated)		4.500	5.563	6.625	8.625	10.75	12.75	14.00	16.00	18.00	24.00
Gage	inches	Maximum differential head limitations (ft)									
20 Ga	0.036	60	35	20	0	0	0	0	0	0	0
18 Ga	0.048	140	75	45	20	0	0	0	0	0	0
16 Ga	0.060	250	145	90	40	20	0	0	0	0	0
14 Ga	0.075	460	260	160	80	40	25	20	0	0	0
12 Ga	0.105	1,040	630	400	200	110	70	50	35	0	0
10 Ga	0.135	1,810	1,140	750	390	220	135	105	70	50	0
8 Ga	0.164	2,660	1,740	1,190	640	360	230	180	125	90	0
7 Ga	0.179	3,130	2,090	1,450	790	460	290	230	160	110	0
3116	0.188	3,415	2,300	1,610	890	520	330	260	180	130	60
7132	0.219	4,430	3,070	2,200	1,260	750	500	390	270	200	90
Sch. 40	0.237	5,035	—	—	—	—	—	—	—	—	—
114	0.250	—	3,880	2,840	1,680	1,030	690	550	390	290	130
Sch. 40	0.258	—	4,090	—	—	—	—	—	—	—	—
Sch. 40	0.280	—	—	3,490	—	—	—	—	—	—	—
9132	0.280	—	—	—	2,140	1,350	910	730	520	390	180
5116	0.312	—	—	—	2,625	1,690	1,160	930	680	510	240
Sch. 40	0.322	—	—	—	2,785	—	—	—	—	—	—
11132	0.344	—	—	—	—	2,065	1,445	1,175	860	650	310
Sch. 40	0.365	—	—	—	—	2,325	—	—	—	—	—
318	0.375	—	—	—	—	—	1,970	1,420	1,055	800	390
Sch. 40	0.406	—	—	—	—	—	2,045	—	—	—	—
Sch. 40	0.438	—	—	—	—	—	—	1,975	—	—	—
7116	0.438	—	—	—	—	—	—	—	1,490	1,145	580
Sch. 40	0.500	—	—	—	—	—	—	—	1,970	—	—
Sch. 40	0.562	—	—	—	—	—	—	—	—	1,965	—
Sch. 40	0.688	—	—	—	—	—	—	—	—	—	1,645



where:

- $P_d$  = design collapse pressure, lb/in<sup>2</sup> [alternatively,  
2.31 ( $P_d$ ) = head, in feet]  
 $Y_p$  = yield strength, lb/in<sup>2</sup>  
 $e$  = casing eccentricity  
 $P_{cr}$  = critical collapse pressure of a perfect cylinder,  
lb/in<sup>2</sup>, given by

$$P_{cr} = \frac{2E}{(1-\mu^2)[SDR(SDR-1)^2]} \quad (\text{eq. 32-2})$$

where:

- $E$  = Young's modulus of elasticity, lb/in<sup>2</sup>  
 $\mu$  = Poisson's ratio  
 $SDR$  = standard dimension ratio,  $d/t$   
 where:  
 $d$  = outside diameter of casing, in  
 $t$  = wall thickness of casing, in

Figure 32-10 may be used to determine maximum allowable differential head for ASTM A-139 Grade

B carbon steel casing. The curve in figure 32-10 is a smooth plot of standard dimension ratios (SDR) for steel casing in table 32-5, versus calculated critical collapse pressures (expressed as head, in feet), using the Timoshenko Elastic Formula. The curve simplifies the determination without having to run the Timoshenko calculation. The curve ( $P_{cr}$  is in feet of head) may be expressed as:

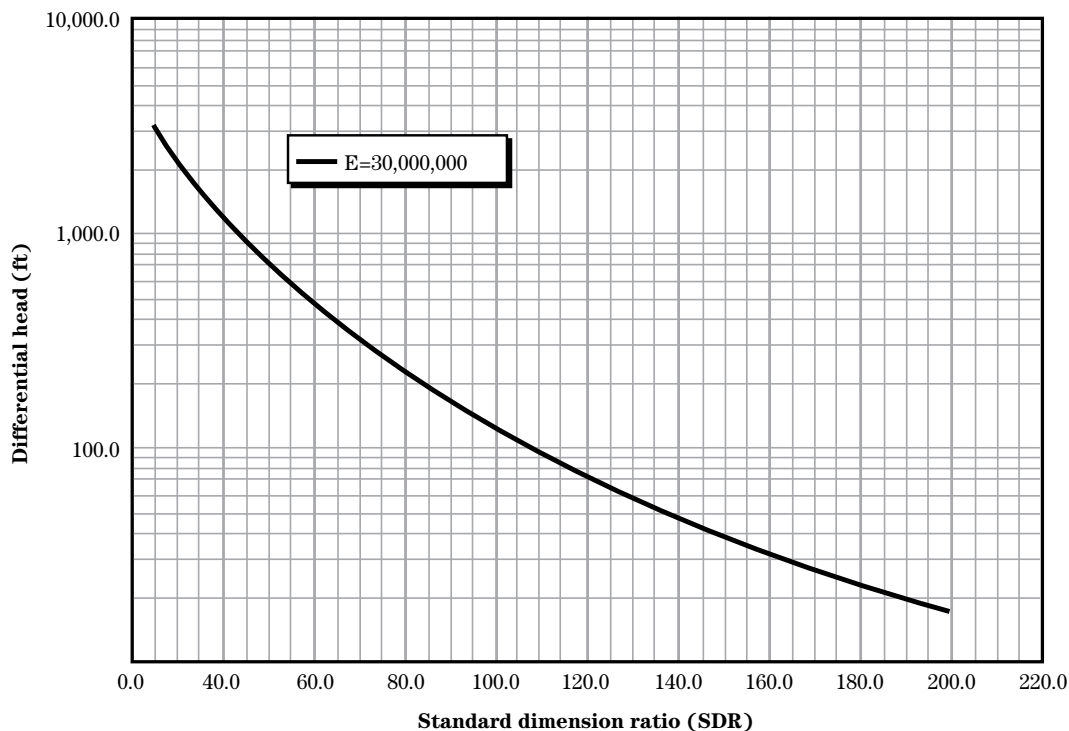
$$P_{cr} = 1.4897 \times 10^7 (SDR)^{-2.5526} \quad (\text{eq. 32-3})$$

### (ii) Plastic casing

Critical collapse resistance for SDR pressure-rated plastic pipe, denoted either PR or SR-PR, including ABS, PVC, and SR, is determined by the Clinedinst equation (ASTM F-480). The Clinedinst equation is:

$$P_{cr} = \frac{2E}{(1-\mu^2)[SDR(SDR-1)^2]} \quad (\text{eq. 32-2})$$

**Figure 32-10** Maximum allowable differential head for steel pipe



where:

$P_{cr}$  = critical collapse pressure, lb/in<sup>2</sup> [alternatively, 2.31 ( $P_{cr}$ ) = head in feet]

$E$  = Young's modulus of elasticity, lb/in<sup>2</sup> = Poisson's ratio

SDR = standard dimension ratio,  $d/t$

where:

$d$  = outside diameter of casing, in

$t$  = wall thickness of casing, in

Table 32-6 gives the maximum allowable differential head limitations for selected PVC, ABS, and SR plastic pipe (SDR-PR), based on the Clinedinst equation, using  $\mu = 0.38$ .

Table 32-7 gives dimension and differential head limitations for PVC-12454 plastic pipe, schedules 40 and 80, constructed of material with  $E = 400,000$  pounds per square inch and  $\mu = 0.38$ , based on the Clinedinst

equation. Factors given at the bottom of table 32-7 may be used in determining limitations for ABS schedules 40 and 80 plastic pipe.

Table 32-8 provides dimension and differential head limitations for representative sizes of reinforced plastic (RPMP) well casings.

Figure 32-11 may be used to determine maximum allowable differential head for SDR-PR plastic pipe, including PVC (12454 and 14333), SR, and ABS (434 and 533). Four curves are plotted for representative values of  $E = 500,000$ ; 400,000; 300,000; and 200,000 pounds per square inch and  $\mu = 0.38$ , according to the Clinedinst equation. The maximum allowable differential head for different values of  $E$  may be determined either by interpolation from the curves in figure 32-11 or by direct calculation from the Clinedinst equation.

### Example 1 Collapse resistance for steel casing

*Problem:* A rancher is drilling a stock water supply well and would like to use some new 6-inch (nominal) Grade B Carbon steel casing on hand. Determine whether it meets criteria for maximum allowable head.

*Given:* The aquifer is unconfined, and the greatest anticipated differential head in the well is determined to be 925 feet. The steel casing has the following characteristics:

outside diameter = 6.625 in  
8-gauge steel = 0.164 in

*Solution:*

*Step 1* Calculate the SDR

$$\text{SDR} = \frac{6.625}{0.164} = 40.4 \quad (\text{eq. 32-4})$$

*Step 2* Determine maximum differential head limitation for 8-gauge, 6.625-inch (outside diameter) steel casing, from table 32-5:

Answer= 1,190 feet

*Step 3* Alternative. Use equation for curve in figure 32-10 to calculate maximum allowable differential head (result should be close to answer from step 2):

$$P_{cr} = 1.4897 \times 10^7 (40.4)^{-2.5526} = 1,182 \text{ ft} \quad (\text{eq. 32-5})$$

*Step 4* Decision. Because the greatest anticipated differential head, 925 feet, is less than the maximum allowable, 1,190 feet, the rancher's casing can be used in this well.

**(6) Safety factors**

The data in table 32–5 are plotted in figure 32–10 and are calculated with an assumed eccentricity value of 1.0 percent (0.01) for steel casing. This adjustment is provided to account for out-of-roundness (deviation from rigorous production standards) that may arise in normal shipping and handling. Eccentricity up to 1.5 percent (0.015) can most likely be tolerated. However, collapse pressure needs to be recalculated using the Timoshenko Elastic Formula with eccentricity adjustment. Used casing and casing with obvious eccentricity or other defects should be rejected.

Data for allowable differential head (collapse resistance) in tables 32–5 to 32–8 take into account only unbalanced hydrostatic pressure. Overburden pressure at depth in a vertical well is the sum of the weight of the overburden material and the contained groundwater. Ordinarily, the weight of the formation is borne by the formation itself. Under some circumstances, part or all of the overburden pressure can be transmitted to the interstitial groundwater and may result in casing collapse. Design must also take into consideration conditions that can result in collapse forces (static or dynamic) that exceed hydrostatic pressure.

Example of static conditions:

- Deep confined aquifers can generate significant artesian head on the outside of the casing.

Examples of dynamic conditions:

- Heavily pumped, deep, unconsolidated aquifers are subject to compaction and consolidation processes that can result in formation settlement, movement, and subsidence.
- An improperly installed filter pack (with bridged particles or pockets) can suddenly collapse, resulting in rupture of the casing or screen. In a fine sand aquifer, quick conditions can arise from an upward movement of groundwater. The sand goes into suspension and is then unable to support the weight of the formation. Effective pressure is reduced to zero, and underdesigned casing and screen could collapse.
- Earthquakes and blasting can generate forces that result in rearrangement, consolidation, and settlement of aquifer materials that could cause otherwise satisfactory casing and screen to collapse. Sudden ground motions also can induce liquefaction of saturated fine sands and silts with similar deleterious effects on casing or screens.

**(7) Design guidance**

If the well may be bailed or pumped dry, such as during development or when pumping a low yield well, the elevation of the bottom of the well should be sub-

**Table 32–6** Maximum allowable differential head for selected plastic pipe

SDR	Material (modulus of elasticity, E, lb/in <sup>2</sup> )			
	PVC–12454 (400,000)	ABS–434 (360,000)	SR and PVC–14333 (320,000)	ABS–533 (260,000)
<b>Maximum allowable differential head</b>				
	(ft)	(ft)	(ft)	(ft)
13.5	1,020	920	815	665
17.0	495	445	395	320
21.0	255	230	205	165
26.0	130	120	105	85
32.5	65	60	50	40

**Table 32-7** Dimension and differential head limitations for selected PVC-12454 plastic pipe, schedules 40 and 80

Nominal diameter (in)	Outside diameter (in)	Schedule 40			Schedule 80		
		Minimum wall thickness (in)	SDR	Maximum head (ft)	Minimum wall thickness (in)	SDR	Maximum head (ft)
2	2.375	0.154	15.4	675	0.218	10.9	2,020
2.5	2.875	0.203	14.2	870	0.276	10.4	2,350
3	3.500	0.216	16.2	575	0.300	11.7	1,610
3.5	4.000	0.226	17.7	435	0.318	12.6	1,270
4	4.500	0.237	19.0	350	0.337	13.4	1,045
5	5.563	0.258	21.6	235	0.375	14.8	765
6	6.625	0.280	23.7	175	0.432	15.3	690
8	8.625	0.322	26.8	120	0.500	17.3	470
10	10.750	0.365	29.5	90	0.593	18.1	405
12	12.750	0.406	31.4	70	0.687	18.6	375

Note: Table 32-7 is for PVC schedule pipe having a modulus of elasticity of 400,000 pounds per square inch. For PVC schedule pipe having a modulus of elasticity of 360,000 pounds per square inch, multiply the maximum head by a factor of 0.9. For PVC schedule pipe having a modulus of elasticity of 320,000 pounds per square inch, use a factor of 0.8. For ABS schedules 40 and 80 pipe having a modulus of elasticity of 250,000 pounds per square inch, use a factor of 0.625. In all cases,  $\mu = 0.38$ .

**Table 32-8** Dimension and differential head limitations for reinforced plastic (RPMP)

Casing diameter (in)	Maximum differential head (ft)								
	20	60	100	200	300	400	500	720	1,000
	Minimum wall thickness (in)								
8	0.17	0.17	0.23	0.23	0.23	0.29	0.29	0.33	0.33
10	0.17	0.17	0.28	0.28	0.28	0.36	0.36	0.41	0.41
12	0.18	0.19	0.34	0.34	0.34	0.43	0.43	0.46	0.46
14	0.19	0.22	0.34	0.34	0.40	0.43	0.46	0.46	0.46
15	0.19	0.24	0.34	0.34	0.46	0.46	0.46	0.46	0.46
16	0.20	0.25	0.36	0.36	0.46	0.46	0.46	0.46	0.46
18	0.21	0.28	0.40	0.40	0.46	0.46	0.46	0.52	0.52
20	0.21	0.31	0.42	0.42	0.46	0.46	0.46	0.54	0.54
21	0.21	0.33	0.48	0.48	0.48	0.48	0.48	0.57	0.57
24	0.24	0.38	0.48	0.48	0.48	0.57	0.57	0.57	0.57
27	0.26	0.40	0.49	0.49	0.49	0.62	0.62	0.62	0.62
30	0.29	0.44	0.49	0.49	0.49	0.68	0.68	0.68	0.68
33	0.32	0.44	0.60	0.60	0.60	0.75	0.75	0.75	0.75
36	0.35	0.48	0.65	0.65	0.65	0.82	0.82	0.82	0.82

stituted for the maximum elevation. Also, if maximum drawdown cannot be determined with confidence, it is a prudent practice to use the elevation of the bottom of the well.

If, in addition to unbalanced hydrostatic pressure, conditions at the well site are anticipated to result only in static pressure increases on the casing and screen, use 40 percent of the maximum allowable differential head values provided in the tables and figures. If dynamic increases in pressure are anticipated, the values should be even less.

### (i) Well screen design

The most important part of any well is that area where the water flows from the aquifer into the well. The proper construction and development of this section of the well is necessary for the efficient production of the optimum amount of groundwater.

Consolidated rock aquifers often may be completed as open-hole; that is, no perforated casing or screen is required. If caving or raveling from joints or bedding

planes occurs or is likely to occur, short sections of liner can be set by squeezing or other stabilizing measures used.

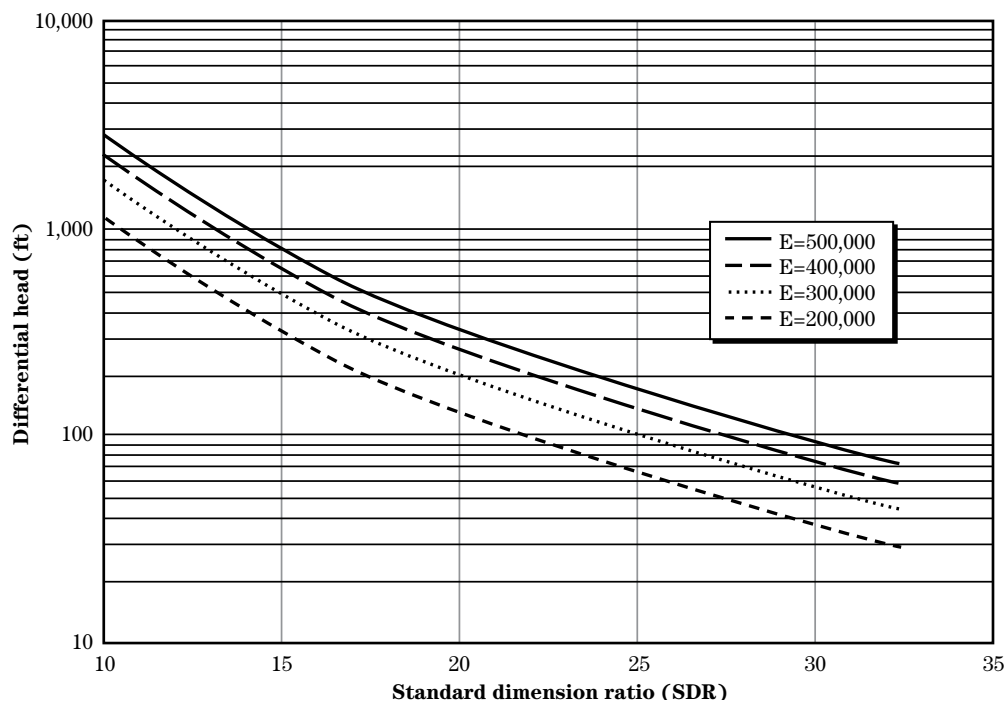
In unconsolidated sand and gravel aquifers, a screen or perforated casing is necessary to allow the water from the aquifer to enter the well and to stabilize the aquifer material.

Poorly designed well screens typically result in either poor water yields or pump sand due to incorrect sizing of the screen openings.

#### (1) Types of screens

Screens are manufactured according to several designs and from a variety of corrosion-resistant materials. One popular type features a continuous horizontal slot formed by wrapping and welding trapezoidal wire about a cylindrical frame of rods. The slot opening is determined by the spacing between the trapezoidal wire wraps and is varied according to specifications. The wire is placed with the wide side out, resulting in an opening that widens toward the inside of the screen. This inward flaring slot reduces clogging of the screen to a minimum. A type having sectioned

**Figure 32-11** Maximum allowable differential head for plastic pipe



horizontal slots is made by wrapping trapezoidal wire over metal strips on perforated steel tubing. The trapezoidal wire is formed with lateral lugs at intervals to maintain the slot width. Another perforated pipe design is like a sand point but much larger. It consists of woven screen of varied gauge wrapped on casing perforated with 5/8-inch holes. The screen is protected by a half-inch mesh galvanized iron hardware cloth. Other screens are galvanized iron casing with punched openings in lattice, crowfoot, shutter, or louvered slit design. Louvered horizontal openings are reported more effective in controlling unconsolidated materials than vertical slots.

Perforations can also be made in the field with a cutting torch, or the casing can be perforated in place in the aquifer with a casing perforator or knife. Openings made in this manner are ragged, uneven, and the open area is small.

Perforations can also be made with a hacksaw either in the shop or in the field. Perforations made in this manner should be oriented transverse to the casing length. Lengths of perforations should be governed by the need for maintaining casing strength and increasing the void ratio to about 20 percent of the area, if possible. They may be a sixth to an eighth the circumference of the pipe, depending on design requirements. Perforations can be placed in rows the full length of an aquifer and separated by equal spacings of unperforated casing. They can be as close together as the width of the slotted voids, making it possible to approach 20 percent of the area for a favorable void ratio.

In most cases, if optimum production from the aquifer is required, spiral-wound well screen is necessary. If less than optimum production is acceptable, one of the less costly mechanically perforated or field perforated well screens can be used.

## (2) Materials

Well screens are subject to corrosion that reduces their effectiveness and may eventually weaken them to the point of failure. All groundwater contains some corrosive or encrusting elements depending on the earth materials it is contained in.

Rate of corrosion depends on characteristics of both metal and water. A screen constructed of a single metal avoids the possibility of galvanic action and electrolytic corrosion. Another method of protecting

against electrolysis is the use of a metal low on the electrochemical scale that will be corroded instead of the casing or screen. Rods of magnesium suspended in the water are excellent for this purpose (Todd 1959).

An analysis of the chemical nature of the water aids in selecting a metal for the screen best suited to the conditions. The following lists the various metals and their recommended usage:

- Monel metal (approximately 70% nickel and 30% copper). Use where waters are extremely aggressive or frequent acidizing will be required.
- Stainless steel (74% low carbon steel, 18% chromium, 8% nickel). Super-nickel metal (30% nickel and 70% copper). Use where the pH value of the water is below 5 or above 8 when the bicarbonate, chloride, and sulfate ions exceed about 60 parts per million. They will stand acidizing treatment, but inhibited acids are recommended.
- Everdur metal (96% copper, 3% silicon, 1% manganese). Silicon red brass (83% copper, 1% silicon, 16% zinc). Anaconda Red Brass (85% copper, 15% zinc). Common yellow brass (approximately 67% copper and 33% zinc). Use when the pH value of the water is between 5 and 6 or above 8. Acidizing with inhibited acid is preferred.
- Armco iron. Use in water with pH between 6 and 8 where mild carbonate deposition on the screen is anticipated. It will stand two or three light acidizing treatments.
- Mild steel, soft iron, galvanized iron or steel, and bitumen or enamel-coated iron or steel have poor to fair resistance to corrosion. The bitumen and enamel coatings usually break and chip during shipment and installation, thereby reducing their effectiveness. These materials can be used where the pH of the water is between 6 and 8 and light carbonate deposition is expected. They will stand one or two light acidizing treatments.

Normally, the more corrosion resistant the screen material, the more expensive. When recommending the type of screen to install in a corrosive environment, comparison of the cost of removal and replacement of

a less costly screen with the cost of a corrosion resistant screen should be made.

### (3) Screen slot size for natural filter pack

The well screen is the intake area of a well. It should be designed so that it will provide sand-free water at its maximum rate of production. This can usually be accomplished by developing a natural or artificially produced sand and gravel filtering zone around the screen.

This zone is commonly called a gravel pack. This term is misleading because packs may consist of different size particles—from fine sand to coarse gravel—depending on the size and gradation of the aquifer materials. The terms, “natural filter pack” and “artificial filter pack” are more accurate.

The filter pack, in effect, increases the diameter of the well and reduces head loss, which results in a more efficient well. A natural filter pack is developed by removing, through the screen, the fine material of the aquifer adjacent to the screen. An artificial filter pack is placed, from the surface, in the annular space between the aquifer and the screen.

The width or diameter of the openings in the well screen is commonly called slot size. The optimum slot size is the largest size that will maintain the stability of the aquifer or pack material and is determined by analysis of the grain size distribution curve.

The uniformity coefficient (Cu) of aquifer or pack material is the ratio of the 60 percent finer material ( $D_{60}$ ) to the 10 percent finer material ( $D_{10}$ ):

$$Cu = \frac{D_{60}}{D_{10}} \quad (\text{eq. 32-6})$$

It is a means of grading or rating uniformity of grain size. A Cu of unity means the grains of the material are practically all of the same size, while a large Cu indicates a large range in sizes.

If the uniformity coefficient of the aquifer material is 2.0 or less, an artificial filter pack is usually required. If no coarse particles (between 0.5 and 1.0 mm) are present, an artificial filter pack is usually be required, even though Cu is greater than 2.0.

The Cu of aquifer materials is a guide, but there are no hard and fast rules on when an artificial filter pack is or is not required. Experience with other wells in the same area with similar conditions will help to determine if an artificial filter pack is required.

The slot size for a naturally developed filter pack in a sand aquifer should be sized so that about 60 percent ( $D_{60}$ ) of the aquifer material enters the screen (Johnson 1975). If the water is corrosive, a slot size to pass 50 percent ( $D_{50}$ ) is recommended because corrosion may eventually increase the slot size enough to allow the well to produce sand.

Figure 32-12 is an example of a grain size distribution graph of a sand aquifer. The Cu is 2.1, which is on the borderline of requiring an artificial filter pack. Most well screen slots are fabricated in even increments of 0.01 inches. Here, the actual design size is 0.024, which is between fabricated sizes 0.020 and 0.030. In practice, the next smaller (0.020) size is installed.

If the aquifer is coarse sand and gravel, a slot size to pass 50 to 70 percent ( $D_{50}$  to  $D_{70}$ ) of the aquifer material is recommended (fig. 32-13). The 70 percent size allows more of the aquifer material to enter the well and, therefore, development of the well takes longer and is more expensive.

The U.S. Bureau of Reclamation (USBR) (1964) recommends for a naturally developed filter pack, a slot size equal to half the  $D_{85}$  size of the aquifer material. They also make adjustments in grain size distribution curve if there is a sharp break in the curve where some sizes are missing or if Cu is large. In most cases, the USBR's method and the method described give about the same designed slot size.

*Artificial filter pack (gravel pack)*—the following tabulation lists conditions when it may be desirable to install an artificial filter pack:

- To stabilize fine-grained, poorly sorted sand aquifers to avoid sand pumping
- To permit the use of larger slot openings and resultant better well efficiency in fine-grained aquifers

**Figure 32-12** Grain size distribution for a sand aquifer

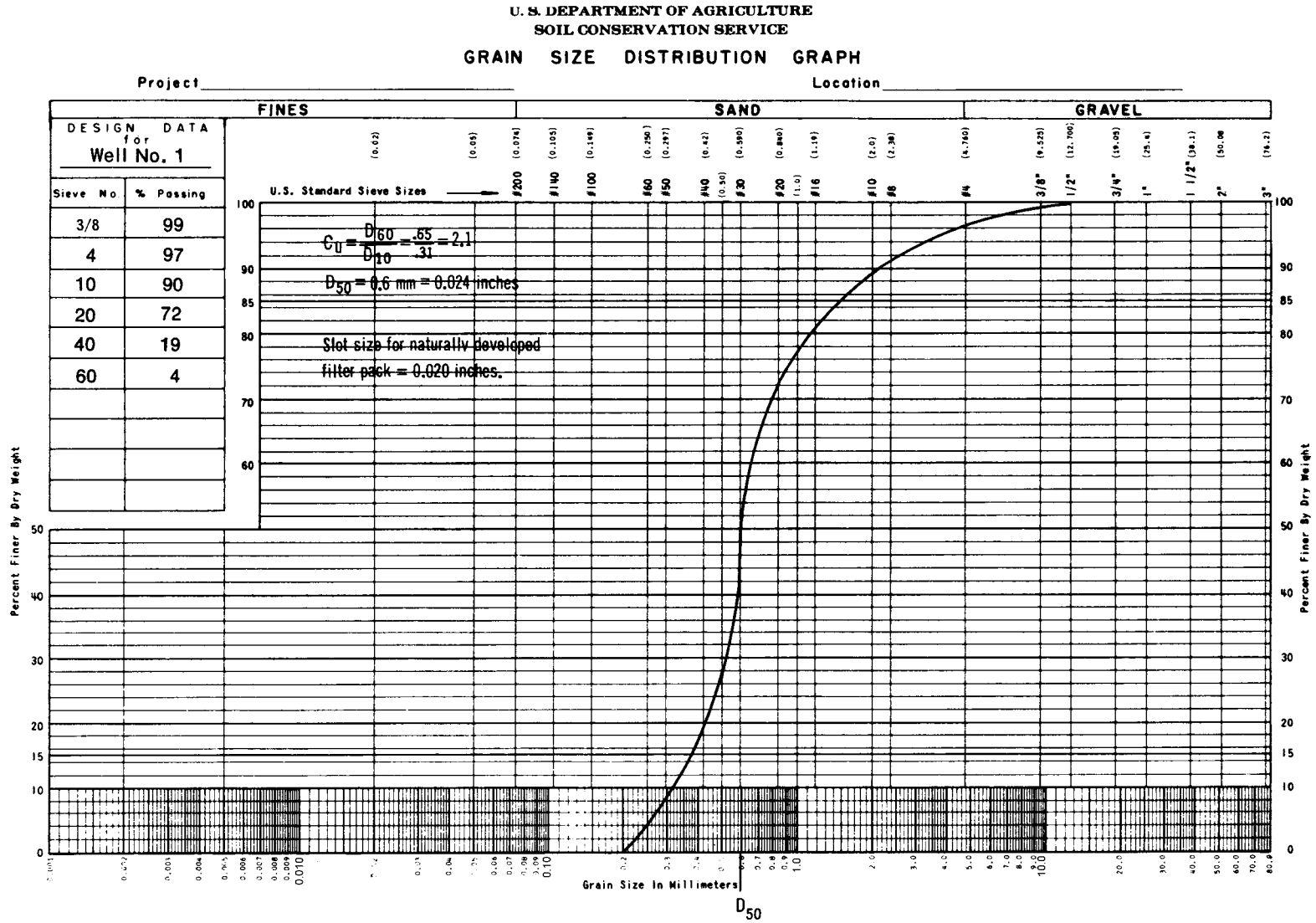
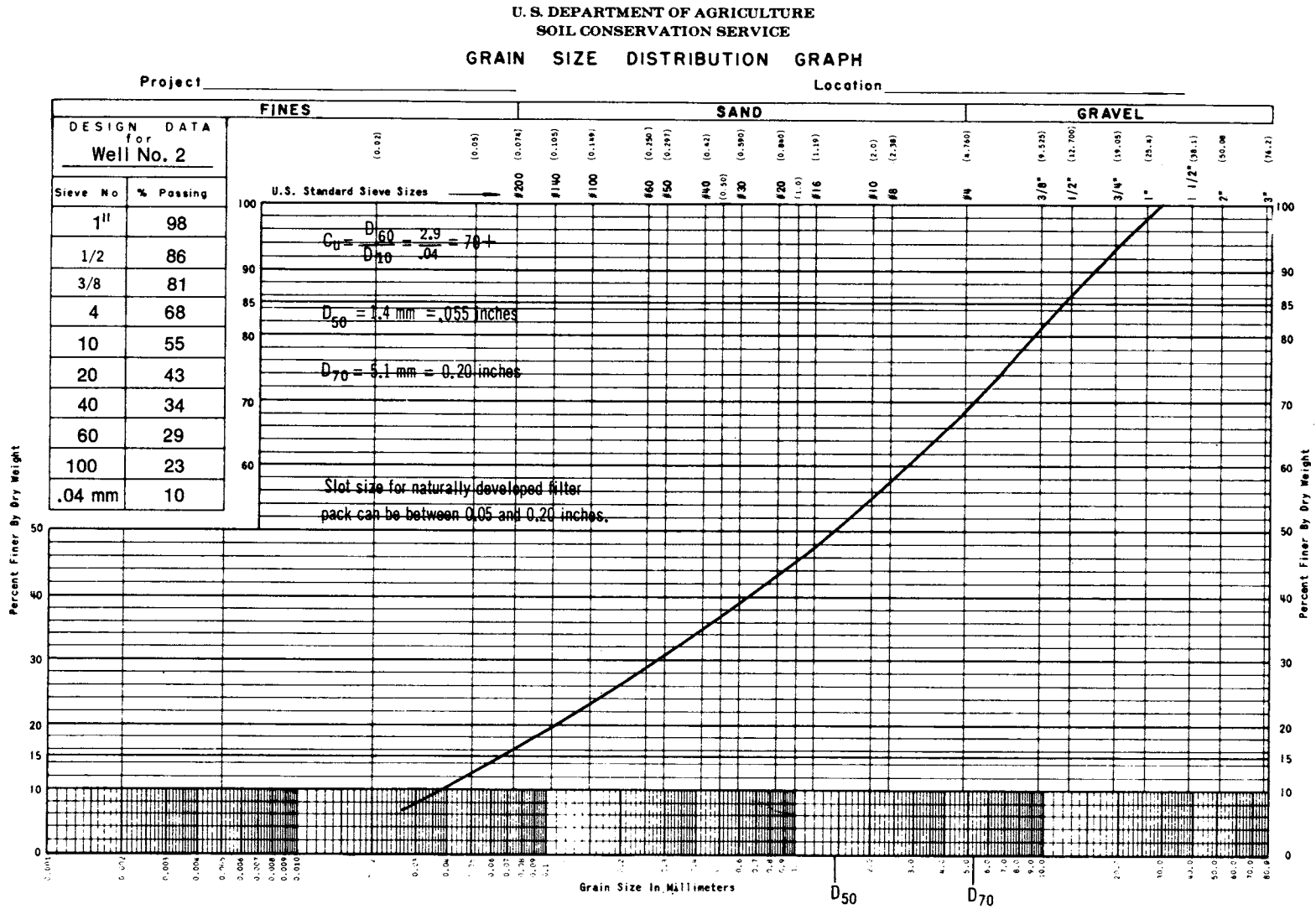




Figure 32-13 Grain size distribution for a sand and gravel aquifer



In formations of thin alternating zones of coarse and fine aquifer material, it is difficult to position screens of various slot sizes accurately. The use of an artificial filter pack will permit use of a single slot size screen and eliminate the positioning problem.

In deep-lying aquifers it may be less costly to set a small diameter artificially filter packed screen in an under-reamed section of hole than to drill the full diameter hole to total depth.

Loosely cemented, fine-grained sandstone aquifers that cannot be completed open hole because of sand pumping and require very fine slot openings to properly retain the sand can advantageously be constructed with an artificial filter pack.

One indication of the need for an artificial filter pack may be determined from the uniformity coefficient of the aquifer materials. If  $C_u$  is less than 2.0 and  $D_{10}$  size is less than 0.01 inches (0.25 mm), a filter envelope may be necessary. An artificial filter pack may also be installed in an aquifer containing fine materials when it is desirable to use larger well screen openings than are indicated by the sieve analysis. This usually occurs when  $C_u$  is between 2.0 and 3.0 and  $D_{60}$  is less than 0.017 inches (0.42 mm).

The most satisfactory size of filter material is that size which minimizes head losses through the pack and at the same time prevents excessive sand movement into the well. A filter pack mixture of varying sizes is unsatisfactory because the smaller particles fill the spaces between the larger ones, thereby reducing the voids and increasing resistance to water flow.

The sizes of filter material to be used are determined from a sieve analysis of the aquifer material. They are based on a relationship between the material used in the pack and the size of sand found in the aquifer. This relationship is known as the Pack-Aquifer (P-A) ratio and is defined as the size of sieve opening that will pass 30 percent of the filter material in the pack, divided by the size of sieve opening that will pass 30 percent of the aquifer material (Johnson 1975):

$$P - A \text{ ratio} = \frac{D_{30} \text{ for the pack}}{D_{30} \text{ for the aquifer}} \quad (\text{eq. 32-7})$$

Head losses through filter packs increase as P-A ratios decrease. To minimize these losses, the lower limit of

the P-A ratio should be 4.0. Sand movement increases as P-A ratios increase, and ratios exceeding 9.0 become unstable. For this reason the upper limit of the P-A ratio is 9.0.

The design of the filter pack is done in the following steps:

*Step 1* Construct a grain size distribution graph of the aquifer material. The filter pack design is based on the gradation of the finest aquifer material that is to be screened.

*Step 2* Multiply the  $D_{30}$  size by a factor of four to nine. A factor of four is used if the formation is fine and uniform ( $C_u$  less than 3.0); six if it is coarse and nonuniform; and up to nine if it is highly nonuniform and contains silt.

*Step 3* Plot the point from step 2 on the 30 percent abscissa, and draw a smooth curve with a uniformity coefficient of about 2.5 through it. This is the gradation of the optimum filter pack.

*Step 4* An envelope curve of the permissible limits of the filter pack is drawn, plus or minus eight percent of the optimum curve.

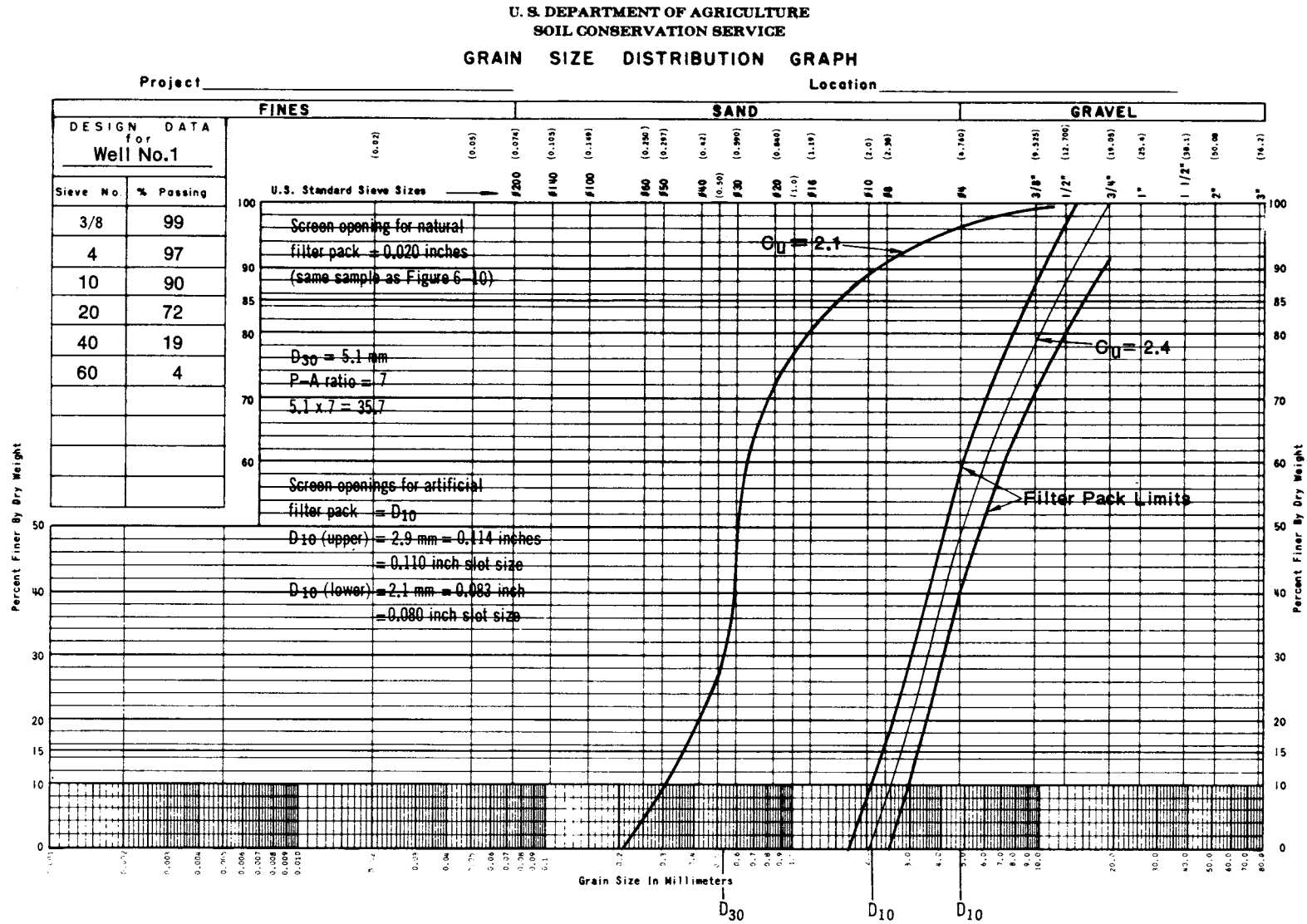
*Step 5* Select well screen slot openings that will retain 90 percent of the filter material.

*Step 6* Gravel or sand for the artificial filter pack should be of washed, well-rounded, hard, and insoluble particles.

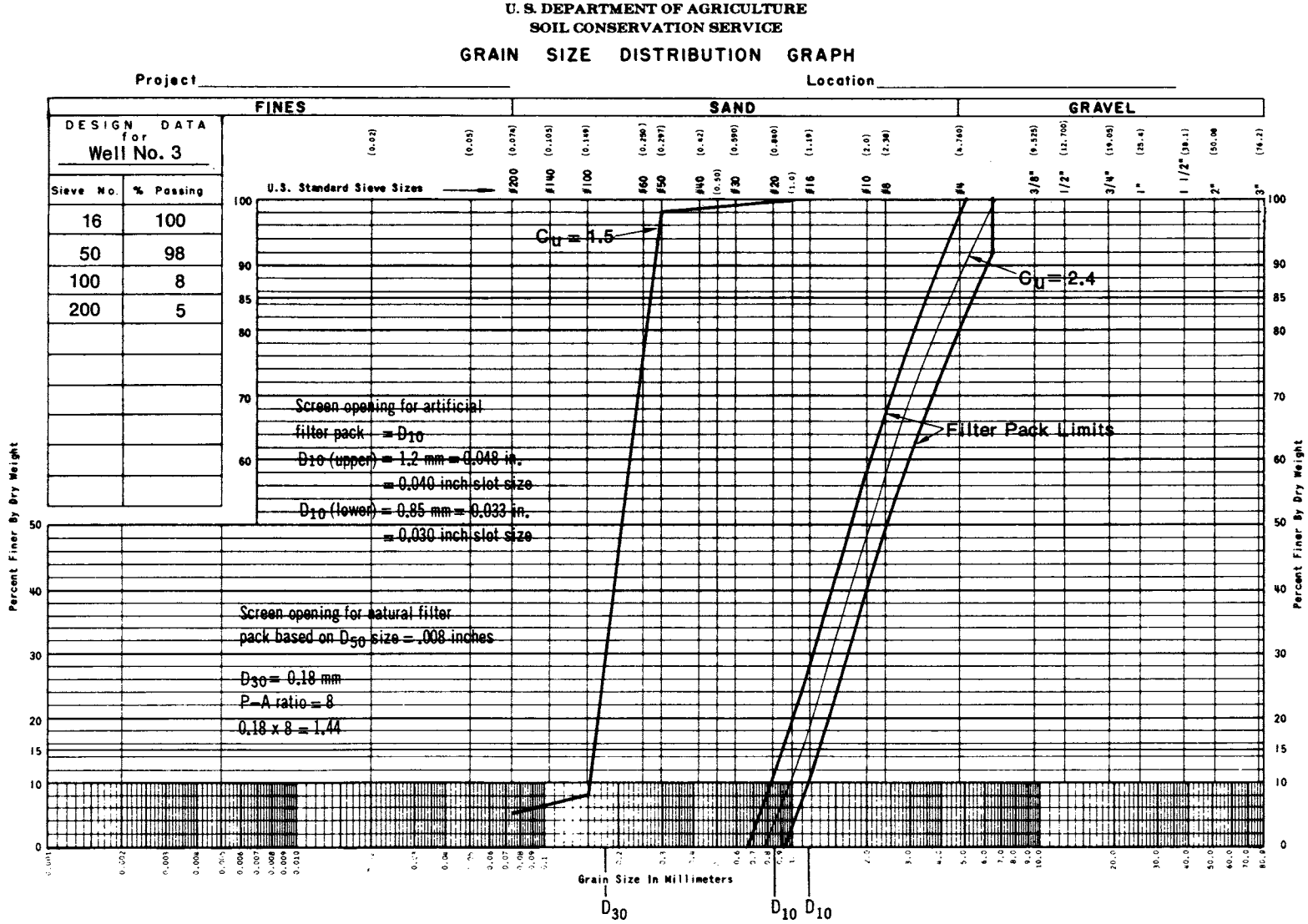
The method for selecting filter pack sizes and determining screen opening limits is illustrated in figures 32-14 and 32-15. The screen opening limits without an artificial filter pack are given for comparison. The opening limits with the artificial envelope are two to three times those without.

Natural subrounded material and crushed rock have been tested to develop design criteria for protective filters draining foundations of engineering structures. The following criteria are given as a guide for filters used in canal structures or other hydraulic structures involving high water heads, where rapid dissipation of uplift pressure is desired. In the following ratios, FM represents the filter material, BM the base material, and R the FM-F:M ratio (equivalent to P-A ratio described earlier).

Figure 32-14 Artificial filter pack design for a sand aquifer



**Figure 32-15** Artificial filter pack design for a sand aquifer, example 2



For uniform grain size filters:

$$R_{50} = \frac{50 \text{ percent size FM}}{50 \text{ percent size BM}} = 5 \text{ to } 10 \quad (\text{eq. 32-8})$$

For graded filters of subrounded particles:

$$R_{50} = \frac{50 \text{ percent size FM}}{50 \text{ percent size BM}} = 12 \text{ to } 58 \quad (\text{eq. 32-9})$$

$$R_{15} = \frac{15 \text{ percent size FM}}{15 \text{ percent size BM}} = 12 \text{ to } 40 \quad (\text{eq. 32-10})$$

For graded filters of angular particles:

$$R_{50} = \frac{50 \text{ percent size FM}}{50 \text{ percent size BM}} = 9 \text{ to } 30 \quad (\text{eq. 32-11})$$

$$R_{15} = \frac{15 \text{ percent size FM}}{15 \text{ percent size BM}} = 6 \text{ to } 18 \quad (\text{eq. 32-12})$$

The ratio range (5–10) for uniform grain size filters agrees fairly closely with the ratio range (4–9) recommended here for filter envelopes.

The ratio range for graded filters of subrounded particles has higher limits than P–A ratios for nonuniform gravel packs of well-rounded particles (Kruse 1960). The following values should be used as upper limits of P–A ratios for a stable filter.

Aquifer	Gravel pack	Limiting P–A ratio
Uniform	Uniform	9.5
Nonuniform	Uniform	13.5
Uniform	Nonuniform	13.5
Nonuniform	Nonuniform	17.5

Materials with uniformity coefficients of 1.3 to 2.0 are considered uniform and from 3.0 to 5.0, nonuniform.

Filters for foundations are designed to permit water flow and relieve pressure, while permitting no movement of base materials. High permeability, allowing large water flow, is usually a secondary consideration. Filter envelopes for wells, however, must have high permeability and permit very little to no aquifer (base material) movement.

To meet well requirements, P–A ratios for graded, subrounded materials or crushed rock should be selected at or near their minimum ratios. These minimum ratios agree closely with, though are slightly lower than, P–A ratios for nonuniform well-rounded materials recommended by Kruse.

#### (4) Screen diameter and entrance velocity

An entrance velocity of water through a well screen that approaches but does not exceed 0.1 foot per second is a criterion in most water well standards. It has proven to be a useful integration of the aquifer characteristics and overall well design and is included in most published water well standards and recommendations. The American Water Works Association (AWWA) Standard A-100-06 no longer stipulates a maximum screen entrance velocity. The AWWA cites recent research and testing that indicate that allowable well screen velocities are a function of the aquifer characteristics, the overall well design and intended performance, and the quality of the groundwater being pumped. This velocity limit has a marked effect on the amount of sand carried into the well, head losses in the screen, and the rate of incrustation or corrosion. The diameter of the screen can be determined to provide enough total area of screen openings so that entrance velocity will approach 0.1 foot per second after the length and slot size are fixed.

Most screen manufacturers furnish tables of open area per foot of screen for the various slot openings and diameters they manufacture. With these tables, the transmitting capacity of the screen can readily be calculated. An example of this calculation follows.

The desired discharge of a well is 400 gallons per minute through a 10-foot section of 0.040-inch slot screen. What is the minimum diameter screen that will provide this yield at the desired 0.1 foot per second or less entrance velocity?

An 8-inch telescoping screen has 87 square inches of open area per foot of screen and:

$$Q = AV \text{ or } V = \frac{Q}{A} \quad (\text{eq. 32-13})$$

$$V = \frac{400 \text{ gpm}}{870 \text{ in}^2} \cdot 0.32 = 0.15 \text{ ft/s} \quad (\text{eq. 32-14})$$

0.32 is a conversion factor obtained as follows:

$$\frac{\text{gal}}{\text{min}} \frac{1}{\text{in}^2} \frac{\text{ft}^3}{7.48 \text{ gal}} \frac{1 \text{ min}}{60 \text{ s}} \frac{144 \text{ in}^2}{1 \text{ ft}^2} = 0.32 \quad (\text{eq. 32-15})$$

An alternate method is to calculate the quantity of water that will flow through the screen at the permissible velocity of 0.1 foot per second and compare it to the required quantity. This is done by multiplying the open area per foot of screen times the conversion factor, 0.31.

$$87 \text{ in}^2 \quad 10 \text{ ft long} \quad 31 = 270 \text{ gal/min} \quad (\text{eq. 32-16})$$

The conversion factor 0.31 is obtained from:

$$Q = AV = \text{in}^2 \frac{0.1 \text{ ft}}{\text{s}} \frac{1 \text{ ft}^2}{144 \text{ in}^2} \frac{60 \text{ s}}{\text{min}} \frac{7.48 \text{ gal}}{\text{ft}^2} = 0.31 \quad (\text{eq. 32-17})$$

The analysis by the two methods shows that the entrance velocity is too high, and a larger diameter screen is required.

A 12-inch, 0.040-inch slot screen has 130 square inches of open area per foot. The entrance velocity for 400 gallons per minute is:

$$V = \frac{400}{1300} (0.32) = 0.099 \text{ ft/s} \quad (\text{eq. 32-18})$$

The quantity of water flowing through the screen at the permissible velocity is:

$$Q = 130 \text{ in}^2 \quad 10 \text{ ft} \quad 0.31 = 400 + \text{ gal/min} \quad (\text{eq. 32-19})$$

A 12-inch screen is the minimum size that will provide the required quantity of water at the permissible velocity.

It must be emphasized that these calculations are an analysis of the hydraulic characteristics of the screen itself at an arbitrary entrance velocity and do not consider the hydraulic characteristics of the aquifer.

### (5) Placing well screen

Two methods are generally used to install well screens.

- Under most conditions, it is desirable to telescope the screen through the casing. In this technique, at least 5 feet of blank casing the same diameter as the screen is attached to the top of the screen and extends into the bottom of the casing when the screen is in place. The space between the top of the screen assembly and casing is sealed by a lead packer or other suitable material. The blank casing should be long enough so that the top of the screen is at least 2 feet and preferably 5 feet below the top of the aquifer. This will allow for the caving of overlying material due to removal of fines from the aquifer during development of the well.
- The other technique is to fasten the screen to the bottom of the casing and install them as one unit. This makes removal and repair or replacement of the screen impractical. In all cases, the vertical relationship of the top of the screen and aquifer explained above must be maintained.

Most aquifers are not isotropic and contain alternating beds or zones of different gradation. Well screen slot sizes should be designed for this variable gradation. Installing a multiple slot size well screen where fine material overlies coarse, the fine-slotted screen should extend 2 to 5 feet into the coarse zone. This will prevent fine material from entering the coarse screen when the formation slumps during development. If very fine sand, silt, or clay zones are present in an aquifer, blank casing should be set opposite them.

To prevent aquifer material from entering the screen from the bottom, it must be closed. This can be accomplished by welding a metal plate in a section of blank casing on the bottom of the screen or by cement grout. If bail-down or wash-down shoes are used, they should incorporate a device for closing the bottom opening after the screen is in place.

Metals used in screen assemblies should be the same as far as possible. Dissimilar metals below the water table create galvanic currents, which may accelerate corrosion.

In theory, a filter pack thickness of only two or three grain diameters will successfully control the aquifer material. In practice, 3 inches is about the minimum thickness of an artificial filter pack that can be in-

stalled. A filter pack greater than about 8 inches does not increase the yield of the well and makes development more difficult.

Artificial filter packs may be placed by tremie, pumped, or by other suitable method. Care should be taken to ensure that the screen is centered in the well, so the filter pack is placed on all sides of the screen. The method of placing the filter pack must not result in segregation of the sizes of the pack material.

In wells drilled by the rotary method, it is necessary to make the diameter of the hole a few inches larger than the diameter of the screen. This provides clearance for setting the screen. After the screen has been set, it is recommended to fill this annular space to prevent fines overlying the aquifer from caving. The material used in this procedure is called a formation stabilizer, with a gradation like the aquifer or slightly larger. The size of the slot openings of the screen is based on the gradation of the aquifer.

### (j) Well development

Well development is the process of removing clay, silt, fine sand, drilling mud, and other deleterious material from the vicinity of the well screen and from behind the filter pack. This increases the permeability of the material surrounding the screen, increasing the efficiency of the well. The following discussion relates to development in unconsolidated deposits.

Wells may be developed using one or more methods including surging, backwashing, jetting, use of compressed air, pumping, use of dry ice, acid, and dispersing agents. Some are more effective than others under certain conditions. Knowledge of drilling methods and how particular formations react to development are requisites for proper selection.

Care must be taken in developing wells. As in other phases of design, use information from the record of materials penetrated to guide development work. Operations such as pumping, surging, jetting, and backwashing should start slowly. Results should be carefully observed, and the tempo of operations increased only if the method is operating as expected. If the aquifer is overlain by fine sand or silt, these materials may be washed down into the aquifer by surging and spoil the well or prolong development work.

Bridging of fine sand in the aquifer close to the well may result from too violent actions at the beginning of work. Bridging of sand in water-bearing formations is important, and knowledge of the process of bridging is necessary to an understanding of development work. When water is pumped from a well, sand particles in the formation have a tendency to move toward the well. Because the steady pull of pumping is in one direction, finer sand grains wedge against each other and bridge across openings between coarser grains. Such bridging can be prevented and fine grains removed by keeping the water agitated by reversing the direction of flow.

#### (1) Surging

Surging is one of the most effective and commonly used methods of developing wells in sand and gravel formations. Surging is working some type of block or plunger up and down in the well so that water is alternately forced out into the surrounding formation and then allowed to flow back into the well. This action loosens fine sand or gravel particles near perforations in the casing and carries finer particles into the well where they can be removed. Surge blocks are illustrated in figure 32-16.

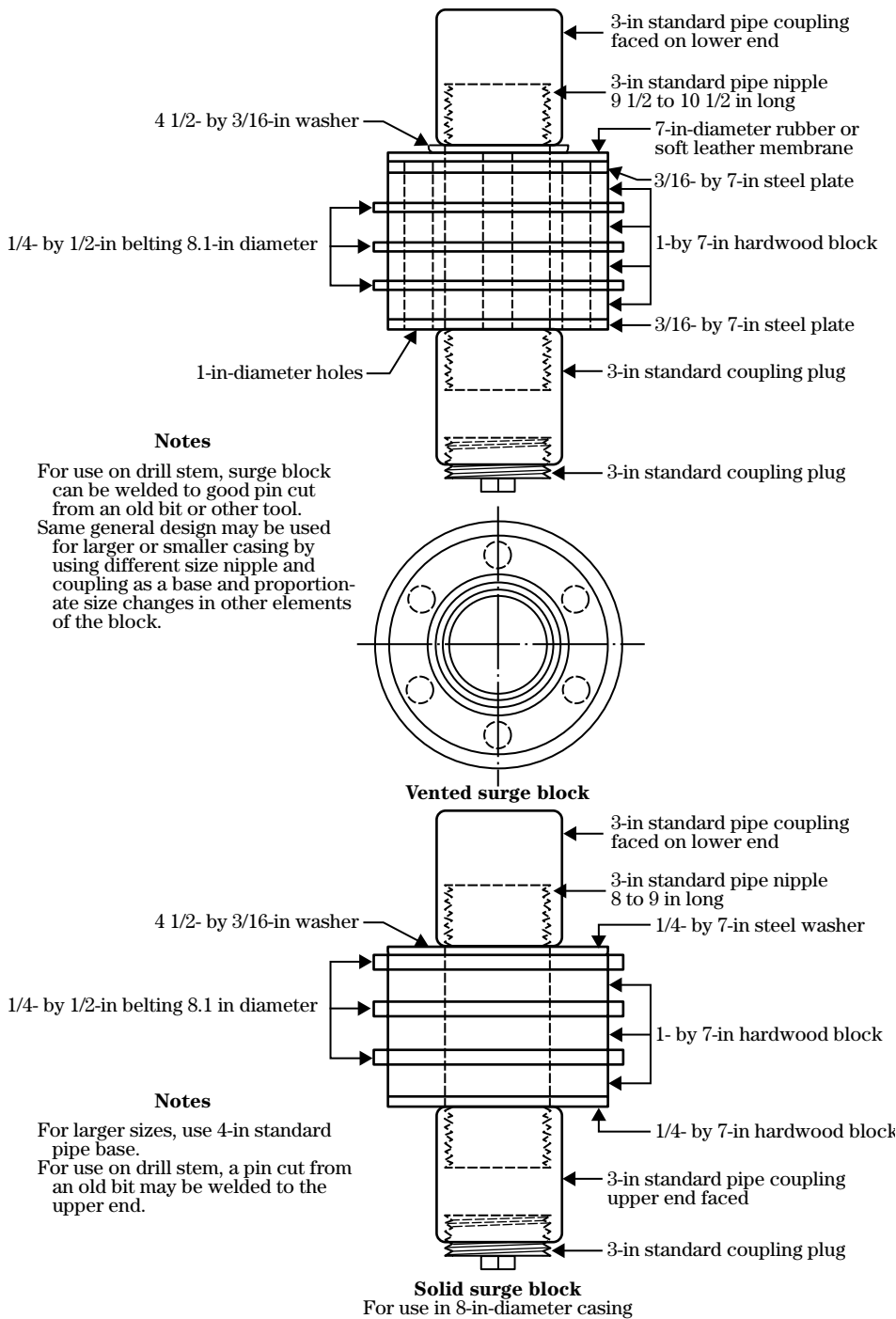
#### (2) Backwashing

Several procedures are used in backwashing, and all produce a surging effect at the perforations or screen. They include use of water and compressed air, and while usually not as forceful as surging with a plunger, are, in some instances, very effective. Backwashing under pressure or with large volumes of water should be done with caution if the casing is not tight or the aquifer is overlain by fine sand, silt, or clay. Provision must be made for frequent removal of fines washed into the well. Backwashing is quick, inexpensive, and effective when there is not a great quantity of fines to be removed.

The simplest method of backwashing is to pour a large volume of water into the well as rapidly as possible and remove it with a bailer or sand pump as soon as possible. The washwater can be reused if screened or dumped into a tank having a settling compartment. The larger the volume of water and the quicker the bailing, the greater is the effectiveness of this method.

A more forceful method of backwashing is to pump a large volume of water into the well under pressure. The water is pumped to the perforations or screen

**Figure 32-16** Surge blocks (from USBR, 1964)





**Example 2 Screen entrance velocity determination**

*Problem:* A new well has been designed to yield 20 gallons per minute to an existing stockwater pipeline. The well driller wants to field-perforate the screen, since no manufactured screen is on hand. Determine if the velocity of water entering the screen is less than 0.1 foot per second.

*Given:* The water-bearing zone is in an alluvial aquifer composed of sands and gravels. Five-inch PVC casing will be used for the well. The driller has determined that an 8-foot-long screen section with  $\frac{1}{8}$ -inch-wide slots made with a circular saw will retain about 40 percent of the aquifer material and allow natural development of the well. The driller will cut 15, longitudinal, 3-inch-long slots per foot.

*Solution:*

*Step 1* Calculate the open area for the 8-foot screen:

$$\begin{aligned} \text{Open area} &= (\text{slot width, in})(\text{slot length, in})(\text{no. of slots/ft})(\text{slot length, ft}) \\ &= (0.125 \text{ in})(3 \text{ in})(15/\text{ft})(8 \text{ ft}) \\ &= \frac{45.00 \text{ in}^2}{144 \text{ in}^2/\text{ft}^2} \\ &= 0.31 \text{ ft}^2 \end{aligned} \quad (\text{eq. 32-20})$$

*Step 2* Calculate the average entrance velocity of water moving into the slots by:

$$Q=VA \quad (\text{eq. 32-21})$$

where:

Q = yield, in  $\text{ft}^3/\text{s}$   
V = entrance velocity, in ft  
A = screen open area, in  $\text{ft}^2$

Therefore,

$$V = \frac{Q}{A}$$

Convert yield in gallons per minute to cubic feet per second:

$$\frac{\frac{20 \text{ gpm}}{7.5 \text{ gal/ft}^3}}{60 \text{ s/min}} = 0.044 \text{ ft}^3/\text{s}$$

Therefore, the entrance velocity is:

$$\begin{aligned} V &= \frac{0.044}{0.31} \\ &= 0.14 \text{ ft/s} \end{aligned}$$

*Step 3* Because 0.14 foot per second is greater than the recommended velocity of 0.1 foot per second, either the screen length or the number of slots per foot must be increased. The width of the slot cannot be increased because the well will then pump sand. Care should be taken to prevent excessive weakening of the screen. To calculate the required length of the screen, determine the amount of open area required at an entrance velocity of 0.1 foot per second. Therefore:

$$V_1 L_1 = V_2 L_2 L_2 = \frac{0.14}{0.1} \frac{8}{0.1} = 11.2 \text{ ft}$$

(eq. 32-22)

*Step 4* An alternative to installing a longer screen is to increase the number of slots per foot or increase their length. The same process as in step 3 is used to determine the required number of slots per foot or the length of slots:

$$\frac{0.14}{0.1} \frac{15}{0.1} = 21 \text{ slots per ft} \quad (\text{eq. 32-23})$$

or

$$\frac{0.14}{0.1} \frac{3}{0.1} = 4.20\text{-in-long slots}$$

through a wash line passing through a cap or bushing at the top of the casing. Pumping is continued for 2 to 5 minutes to establish flow into the aquifer. The cap is then removed, and the well bailed as quickly as possible. Instead of bailing, the well may be flushed hydraulically by addition of a side outlet valve at the top of casing. After application of pressure, this valve is opened and sufficient water pumped down the wash line to bring up the fine materials drawn through the screen.

Backwashing and removal of fines may be accomplished with a turbine pump installed without a foot valve. The procedure is called rawhiding the well and consists of intermittently operating the pump so as to produce relatively rapid changes in pressure head in the well.

The well should be pumped slowly at first with a gradual increase in rate. At each rate, pumping should be continued until no more sand is discharged by the well. This procedure should be continued until maximum capacity of the pump or well is reached. The pump should not be shut down until this preliminary pumping is completed. If pumping is stopped during this stage, there is danger of sand clogging the well or locking the pump. If pumping is started at maximum rate, sand particles may bridge.

When the preliminary pumping has been completed, the well is ready for treatment. Three distinct reactions may be obtained by operating the pump in different ways. The methods are summarized here from Johnson (1959):

- Pump well at fullest capacity until greatest drawdown is obtained. Stop pump and allow water to return to full static water level. Repeat this procedure many times until well shows no further improvement. This method develops the maximum difference in pressure head and an appreciable surge at the well end by return of water in the pump column when the pump is shut down. This method is not as vigorous as the following methods or as severe on the pumping equipment.
- Pump well at fullest capacity until maximum drawdown is obtained. Then stop and start pump alternately at short intervals. This procedure holds the water level down and forcefully agitates the materials at the well end by back-

wash of water in the pump column. Care must be taken not to start the pump while the shaft is still turning backward.

- Run pump until water is lifted to the surface. Stop until water drains back down the pump column. Repeat this process. No effort is made to draw water level down. The object is agitation by starting and then reversing flow.

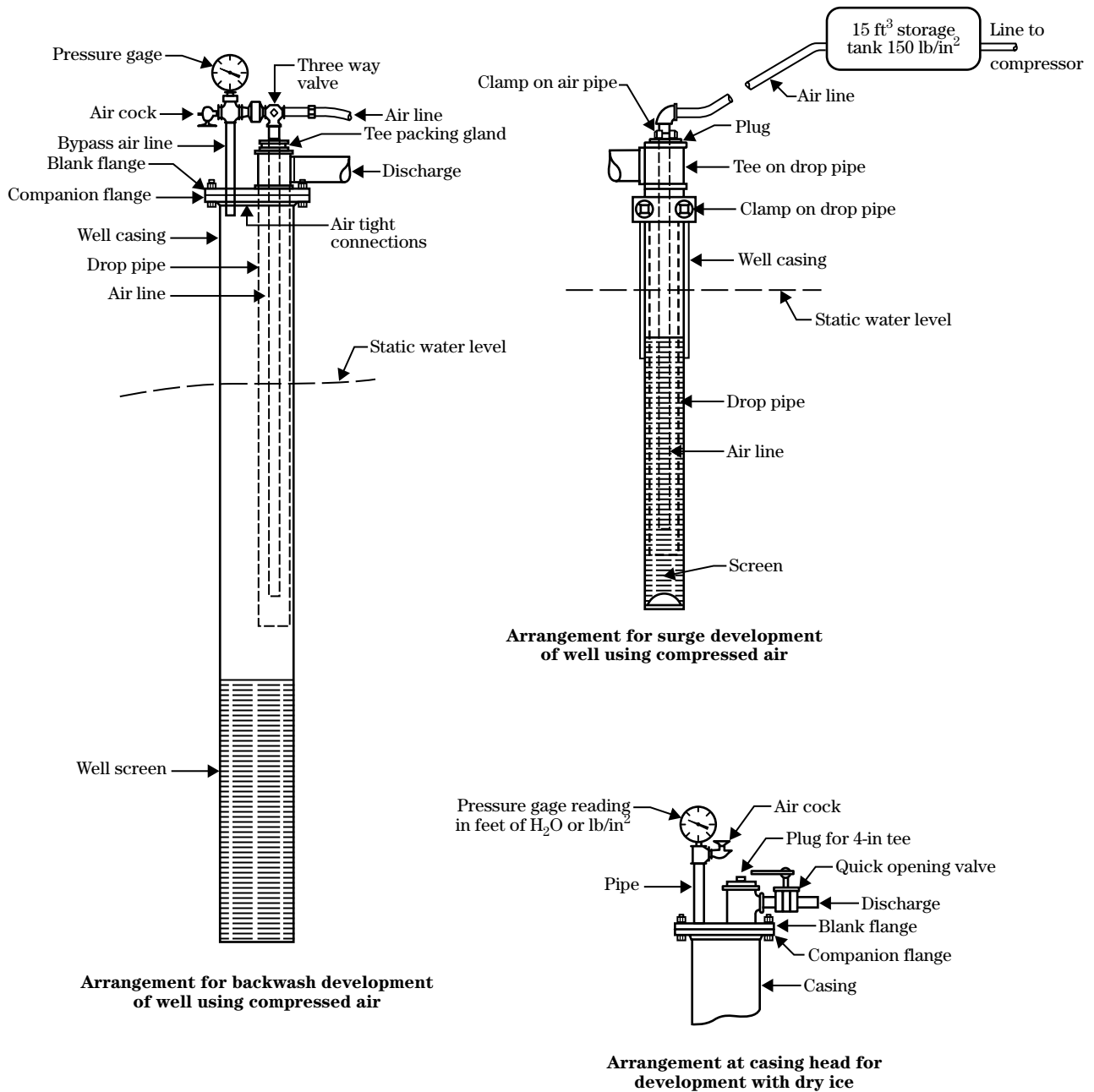
Most drillers who develop wells by rawhiding use a combination of these procedures. Only experiment and experience can determine which will apply at a given location. Rawhiding is not vigorous enough where heavy development is needed, and it is hard on pumping equipment. It is inexpensive, speedy, and effective under proper conditions.

In backwashing wells with compressed air, water is forced out through the perforations or screen by the pressure of air. This method cannot be used unless the water in the well stands at a considerable height above the perforated part of the casing. When this method is used, the top of the casing is sealed with an airtight cap through which an airline extends. The air line is equipped with a three-way valve so that the pressure in the well can be released at any time. When air is turned into the air line, the pressure forces water in the well out through the perforations. When air begins to escape through the perforations, it is shut off, and pressure in the well is released by opening the valve. A pressure gage on the air line shows when the pressure has built up enough to force air through the perforations. When air starts to escape, the pressure will no longer rise. When pressure is released, water will flow back into the well, carrying fine sand with it. Periodically, the cap is then removed, and sand is removed with the bailer. The process should be repeated until no more sand is brought in. To make this method more effective, it should be combined with pumping by air (fig. 32-17).

### (3) Jetting

Jetting is a recent addition to the usual procedures for completing wells. It is described in detail in Johnson (1975). The procedure consists of operating two or four horizontal water jets inside the well so that high-velocity streams of water shoot out through the screen openings. The jetting tool has an outside diameter 1 inch less than the inside diameter of the screen. Horizontal nozzles on its perimeter have orifices 1/4,

**Figure 32-17** Development with air or dry ice (from USBR, 1964)



3/8, or 1/2 inch in diameter. The tool is slowly rotated and gradually raised and lowered so that the entire surface of the screen is jetted. Fine sand, silt, and clay are washed out of the formation around the screen and brought into the well above or below the jet. It is desirable that light pumping to remove fines continue while jetting.

#### (4) Use of air (open well method)

Use of air is an effective means of developing a well through a combination of surging and pumping. Large volumes of compressed air are suddenly released at the bottom of the well, producing a strong surging action and pumping at the same time, as with an ordinary air lift pump. Developing with air is best suited to wells of small diameter where depth of water in the well exceeds two-thirds of the total depth of well.

In using air for development, a drop pipe and an air line are necessary. The drop pipe is lowered to within about 2 feet of the bottom of the well and the air line placed so it is a foot or two up in the drop pipe. The well is pumped by air until the water is free from sand. A valve on the air line is then closed and pressure in the tank built up to 100 or 150 pounds. The air line is lowered a foot or so below the drop pipe and the valve opened quickly, allowing air to rush into the well under full pressure. There will be a brief forceful surge of water; and if the air line is then pulled back into the drop pipe, a strong reverse flow is produced up the drop pipe, effectively agitating the water-bearing formation. The cycle of surging and pumping is continued until the water is free from sand, indicating that development work is complete (fig. 32-17).

#### (5) Over pumping

This is the simplest and probably most common method of finishing wells ending in sand or gravel. It consists of pumping the well at a capacity that will develop excessive or at least greater drawdown than is planned for regular operation. Over pumping clears the well at or above its natural capacity, but accomplishes little actual development because it produces no reversal of flow and little agitation of aquifer materials. It has three weaknesses: it is not effective for increasing production because few fines are removed, over pumping tends to cause bridging of fine sand in the formation and reduction of permeability in vicinity of the well, and it often requires larger pumping equipment than may be conveniently available. A more

effective method should be used if permeability of the aquifer can be increased by development.

#### (6) Dry ice (solid carbon dioxide)

The surge produced is similar to backwashing with compressed air in a closed well except that pressure is built up by evaporation of the dry ice. Light surging in wells 6 inches to 10 inches in diameter may be accomplished by using 10 or 15 pounds of dry ice broken into small pieces, while 25 to 50 pounds will produce a heavy surge. The casing should be open at the top to allow escape of gas and possibly a geyser of muddy water. A rule of the Illinois State Water Survey states, "There is no danger of freezing as long as there are 11 pounds of water in the well for each pound of dry ice used." See figure 32-17.

Dry ice is usually not effective if the depth of water in the well is small in proportion to depth of well. If clay is present, use of a polyphosphate dispersing agent beforehand will improve the effectiveness of treatment.

#### (7) Acids

If the water-bearing sands or gravels are partially cemented by  $\text{CaCO}_3$ , the use of acid with the several methods of well development will assist in improving yield. Acids act to free fine materials and increase void space by dissolving the cement. Dilute hydrochloric acid,  $\text{HCl}$  (usually a 15% solution), is commonly used. Sulphuric acid,  $\text{H}_2\text{SO}_4$ , is used less frequently because products of its reaction (sulphates) are not as soluble in water as chlorides. A recent development, sulfamic acid, a granular material that forms a strong acid when dissolved in water, has many advantages. Its use is described in Johnson (1975). Sulfamic acid should not be confused with sulphuric acid. It reacts to form sulfamates, which are soluble in water. Granular sulfamic acid is shipped in dry form and is convenient and safe to handle. In dry form, it is not irritating to dry skin, but in water solutions becomes a strong acid and should be handled the same as other strong acids.

The kind, method, and quantity of acid needed to facilitate well development depend on the amount of cementing material in the aquifer and the size, depth, and construction of the well.

#### (8) Dispersing agents

Use of polyphosphates in well development assists in removing silt, clay, iron oxide, and manganese oxide. Polyphosphates have the ability to loosen and disperse

these materials, permitting their removal by surging and backwashing. Polyphosphates can be handled safely and are not injurious to pumps.

### (9) Explosives

Explosives are used in some instances in an attempt to increase the yield of wells in rock aquifers.

The following items must be considered in dynamiting wells:

- diameter of the hole
- character of the rock
- rate of drilling
- depth of placement of shot under water

### (k) Pumping tests

Pumping tests are usually conducted for one of two reasons: to obtain information on performance and efficiency of the well from which to base pump and power requirements or to determine the physical characteristics of the aquifer, which furnishes valuable information for water management developments.

Test results show well characteristics and permit estimating optimum pumping rate, pump setting, pump capacity, and power required. Testing is done after completing development and preferably after 30 days of steady pumping. It consists of measuring the static water level, determining whether the well is artesian or nonartesian, determining height of the static water column, and measuring water level and yield while pumping at a near maximum rate.

The optimum yield and required lift may be estimated by converting drawdown by testing the percent of possible drawdown and reference to figure 32-9. The curves shown are average drawdown-yield relations for a large number of wells. Nonartesian wells obtain about 77 percent of possible yield at 50 percent drawdown, and artesian wells produce about 55 percent yield at 50 percent drawdown.

#### Procedure:

*Step 1* Measure depth to static water level and record.

*Step 2* Determine if the well is artesian or nonartesian by reference to the well log for presence of a confining layer. If static water level is above the bottom of confining layer, the well is artesian.

*Step 3* Determine the height of the static water column or 100 percent drawdown. For nonartesian wells, 100 percent drawdown is the depth from the static water level to the bottom of the aquifer or to the bottom of the well if the aquifer is not completely penetrated. For this purpose, 100 percent drawdown in artesian wells is the depth from the piezometric surface to the top of the aquifer. If drawdown extends below the top of the aquifer and part of the artesian aquifer is dewatered, the procedure in step 5 must be proportioned for artesian and nonartesian drawdown.

*Step 4* Pump the well at a near maximum rate (50% drawdown or slightly more), until drawdown and yield are constant at that rate. Drawdown may be considered constant when three measurements 1 hour apart show no change. Several hours to several days of continuous pumping may be required. Record drawdown and yield.

*Step 5* Convert the measured drawdown to percent drawdown and refer to figure 32-9 to estimate the optimum drawdown and yield.

*Step 6* Furnish information on yield, drawdown, etc., to the pump supplier for recommendations on pump and power requirements.

A check on the efficiency of the well screen can be made by installing an observation well in the annular space between the well casing and sides of the drill hole. If the water level in the observation well during a pump test is at a higher elevation than the water in the pumping well, the well screen is not transmitting the water efficiently. It may be desirable, if possible, to rework the well to improve the efficiency of the screen or filter pack.

The procedures and methods of conducting pump tests and examples of the calculations to determine aquifer characteristics are given in NEH631.31.

### (l) Maintenance

Properly performed maintenance can sustain well yields and increase the life of a well. The two main

causes of decreasing well capacities are corrosion and deposition or incrustation.

### (1) Corrosion

Corrosion is the removal of metal in water by chemical or electrolytic action. Methods of protecting against corrosion have been discussed previously in this chapter. If corrosion does impair the well, the only solution is to remove and replace the corroded well screen or casing.

### (2) Incrustation

Incrustation is deposition of foreign material on or around the screen. Corrosive or incrusting salts occur to some extent in all groundwater. Unlike corrosion, incrustation reduces and will, in time, close screen openings.

Incrustations are usually hard and cement-like but may have the consistency of paste or jelly until exposed to air. The causes of incrustation in approximate order of importance are: (1) precipitation of calcium and magnesium carbonate and other materials carried in solution (9 instances out of 10); (2) deposition of suspended silt and clay; (3) growth of bacteria (*Crenothrix polyspora*, *Gallionella ferruginea*, and *Liptothrix*) that feed on iron in the water and close voids in sediments and screen openings with a jelly-like substance; and (4) the growth of slime-forming organisms that feed on ammonia and decomposing organic matter.

Carbonate incrustation occurs because pumping causes a reduction of pressure in the vicinity of the well and liberates carbon dioxide. The water is then unable to carry in solution the former amount of calcium, magnesium and other metal salts. They are deposited as carbonates and oxides on the screen and in the adjacent aquifer.

Reduction of drawdown is the most effective means of slowing deposition of carbonate incrusting materials. Drawdown may be reduced in several ways: by design of the screen to keep entrance losses at a minimum, by thorough well development to increase effective diameter of the well, by pumping at a reduced rate for a longer period of time, and by use of a greater number of smaller wells.

### (3) Acid treatment

When incrustation is rapid, periodic treatment with hydrochloric or other strong acid may be required. The

following procedure for treatment with hydrochloric acid is summarized from Johnson (1955a).

- Determine reason for production decline, if possible. Make a pumping test to have basis for determining effectiveness of treatment.
- Conditions necessary for acid treatment of wells:
- Well screen must be constructed of metal that will not be damaged by the acid.
- Well screen should be constructed of one metal so that electrolytic corrosion will not occur.
- The kind of material incrusting the screen should be determined. Analyze water. If not able to determine nature, try single acid treatment.
- Prepare well and area in vicinity. Shut down all wells within 100 feet.

#### **Method of single acid treatment:**

If muriatic (hydrochloric) acid is used (18° Baume or 27.92% acid), it is better practice to buy an inhibited acid from a chemical supply house. The acid should be introduced at the bottom of the screen using black iron or plastic pipe and fittings.

*Step 1* Fill 5 to 7 feet of screen at a time.

*Step 2* Raise the pipe 5 feet, repeat as necessary, and add 20 percent extra at last setting.

*Step 3* Use glass, earthenware, or a plain steel pitcher to pour acid into funnel. Do not breathe fumes of HCl or reaction. Keep the work area ventilated. Water-slaked lime ( $\text{Ca}(\text{OH})_2$ ) is useful to neutralize spilled acid.

*Step 4* Pump and waste water for 2 hours on completion.

*Step 5* Check water with litmus paper to determine pH.

#### **Outline of procedure for single acid treatment:**

*Step 1* Fill screen with acid.

*Step 2* Let stand 30 minutes to 1 hour.

*Step 3* Stir with pipe for about 1 minute.

*Step 4* Let stand for 2 to 3 hours.

*Step 5* Surge lightly for about 10 minutes with surge block. (Run small stream of water into well while surging, if convenient.)

*Step 6* Surge moderately with solid surge block.

*Step 7* Bail well clean.

*Step 8* Pump for at least 2 hours.

This method is successful in a majority of wells where the principal cementing agent is calcium carbonate ( $\text{CaCO}_3$ ). It may need to be repeated two or three times. If it is to be repeated, place acid in screen, agitate, and remove by pumping or bailing after 30 minutes to 1 hour. The second treatment should then proceed as above.

#### **(4) Polyphosphate treatment**

Accumulations of silt, clay, and oxides of iron and manganese incrusting screens may be dispersed by use of polyphosphates and pumped from the well. Phosphates work in the same manner as household detergents. The following notes are a summary of instructions for use of polyphosphates from Johnson (1955):

*Make pumping test at start to have basis for evaluating treatment. Use 15 to 30 pounds of polyphosphates and 1 to 2 pounds of calcium hypochlorite for each 100 gallons of water in well. The calcium hypochlorite is used with the polyphosphate to kill iron bacteria. The phosphate should be dissolved from a wire basket or burlap bag and not dumped in a tank.*

*Pour solution into well. Surge vigorously to work chemicals in and out through screen openings. Surge with pump for 4 hours, idle 2 hours, surge for 2 to 4 more hours. After chemicals have been in the well 24 hours, they should be surged several times and pumped out to waste. During flushing period, the well should be surged 3 or 4 times at about 10-minute intervals. Pumping should continue until water becomes fairly clean. This treatment should be repeated with a new charge. Two or more repetitions of treatment are usually required. A pumping test should be made to determine the need for repetition.*

*The effectiveness of treatment can be improved by removing the pump and surging with blocks for more positive circulation of chemicals, breaking up and dispersing incrusting materials. The well can then be cleaned by bailing. If this is done, time of surging*

*may be cut in half, but dispersing agent should be left in the well about 24 hours.*

#### **(5) Chlorine treatment**

Chlorine has been found effective in burning up organic slimes that cause stoppage in some localities. Good results have been produced by adding 30 to 40 pounds liquid chlorine to a large well over a period of 10 to 12 hours. The pump need not be removed and may be used to surge well, occasionally. A small amount of corrosion inhibitor should be added to the water to avoid corrosion of the pump.

## 631.3201 Spring development

### (a) Classification of springs

Springs are usually classified according to the geologic structure and forces bringing water to the surface.

The two categories of springs are gravity and artesian. Magmatic springs usually yield highly mineralized hot water that is associated with deep-seated magmas. They will not be discussed here.

#### (1) Gravity springs

Gravity springs are formed by the outcrop of water flowing under action of gravity. Some of the types of gravity springs are depression springs, contact springs, and fracture and tubular springs. A representative occurrence of each type follows.

##### (i) *Depression springs*

Table 32–9 lists the characteristic features of depression springs.

##### (ii) *Contact springs*

Table 32–10 lists the characteristics of contact springs.

##### (iii) *Fracture, joint, and tubular springs*

Table 32–11 lists the characteristics of fracture, joint, and tubular springs.

#### (2) Artesian springs

Artesian springs are formed when the piezometric surface is above the land surface, and the water flows under artesian pressure. Two types of artesian springs are aquifer outcrop springs and fault springs.

##### (i) *Aquifer outcrop springs*

Table 32–12 lists the characteristics of aquifer outcrop springs.

##### (ii) *Fault springs*

Table 32–13 lists the characteristics of fault springs.

### (b) Development of springs

The objective of a spring development is to make groundwater available for use that is unused, under used, or wasted. Where yield or potential yield greatly

exceeds the needs, conservation of the supply may not be a critical consideration in the development. Conversely, where the yield or potential yield is low, proper development should emphasize the full utilization of the available water.

#### (1) Methods

Information should be obtained, preferably during a dry season, on the volume and reliability of present flow, the nature of the water-bearing material, and the hydrogeologic conditions which cause the spring, before proceeding with plans for development. One or more of the following described measures can improve spring flow.

Protection of springs from contamination is of prime concern in any development. The location of possible sources of contamination and direction of groundwater flow must always be considered in planning spring developments.

If a spring is developed for domestic and livestock use, a spring box is usually needed. If the supply of water greatly exceeds the needs, a pipeline can be connected to a sand point or filtering pipe laid or driven into the base of the aquifer or connected with a system of collection lines in the spring area. Where supplies are limited, float-type control valves can be installed to conserve water.

Developments of limited water supplies from low-yielding springs should be planned and developed to maintain a full head of water in the reservoir area of the spring. Excavations made during the installation of spring boxes, wing walls, collector lines, and outlet works will dewater some of the spring area. When the earth materials are replaced after construction is completed, the reservoir capacity of the spring area will not be impaired.

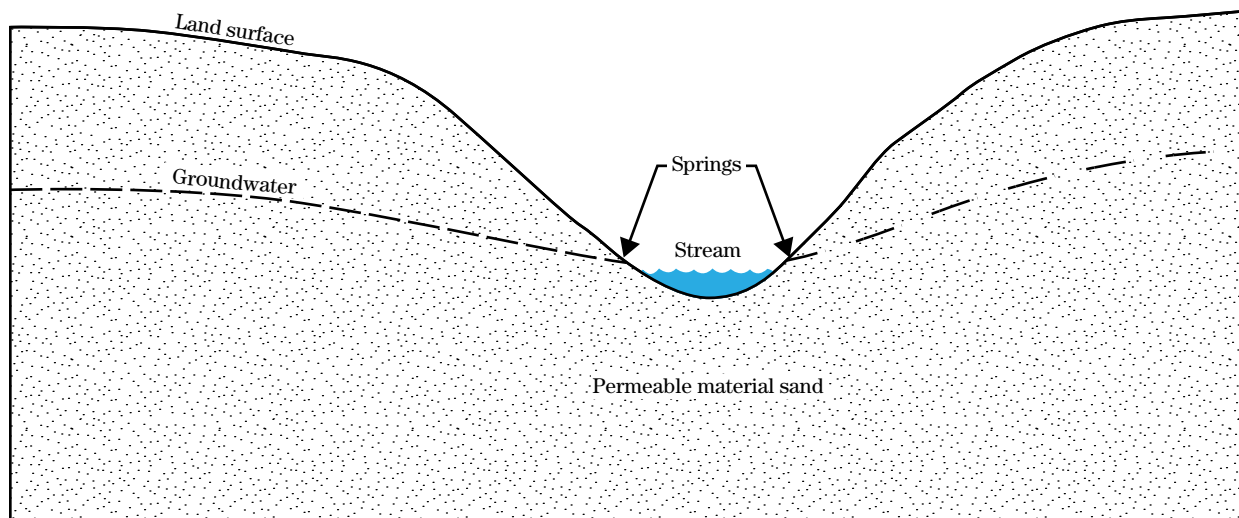
Where wing walls or spring boxes are used, an overflow pipe can be set below the top of the wing wall at the design storage profile of the reservoir (figs. 32–25 and 32–26). The overflow can be piped to a storage tank or outlet into permeable materials away from the spring, keeping the area below the spring dry.

Where fractured rock is the reservoir for a spring, opportunities for control of storage in the spring area are less favorable. A collecting system at the outcrop



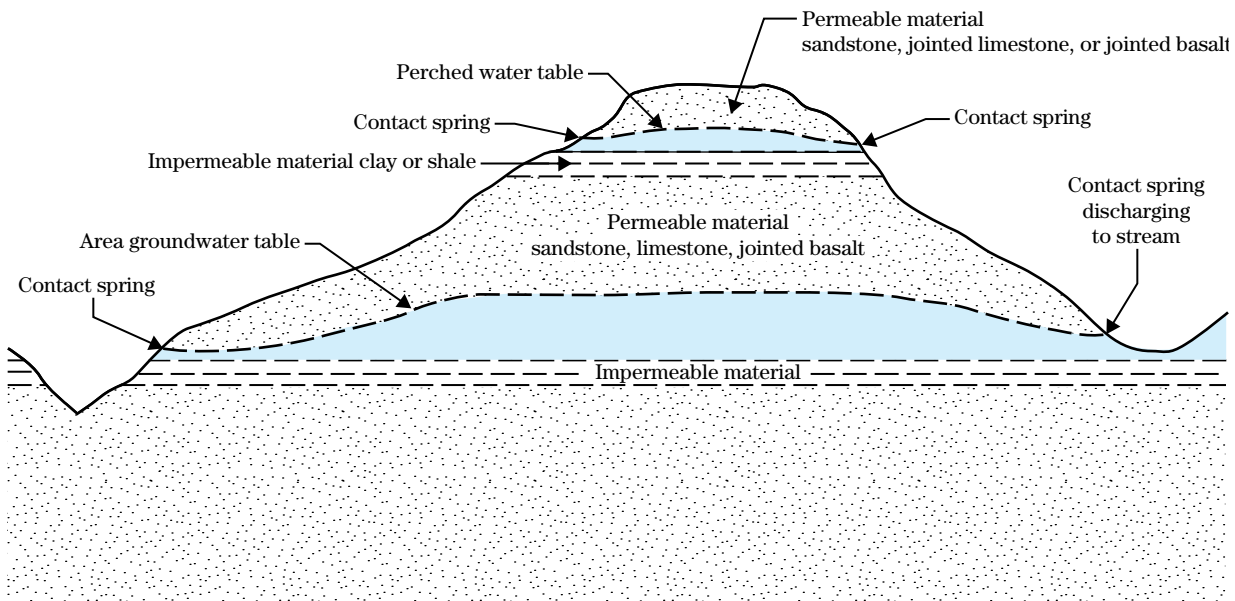
**Table 32-9** Characteristics of depression springs

<b>Location</b>	Along outcrop of water table at edges or in bottom of alluvial valleys, basins, depressions in moraines, and valleys cut in massive permeable sandstone or volcanic ash (fig. 32-18).
<b>Type of opening</b>	Irregular spaces between grains of the material.
<b>Yield</b>	Depends on height and gradient of the water table, permeability of the water-bearing material, and size and intake opportunity of the tributary area. Flow may range from less than one to several gallons per minute.
<b>Type of flow</b>	May be either perennial or intermittent, depending on rise or fall of the water table. If tributary area is small, the flow depends on local precipitation.
<b>Quality of water</b>	Usually fair to excellent, but may be mineralized if the aquifer contains soluble substances.
<b>Water temperature</b>	Temperature of the water will generally approximate the mean annual atmospheric temperature.
<b>Features produced</b>	Usually none in valleys. In humid areas minor slumps, headcuts, or swamping may sometimes develop. In wind-swept arid and semiarid basins the wetted areas and the vegetation growing around spring may cause deposition of material, forming a mound.
<b>Method of development</b>	Remove obstructions to flow, expose additional area of water-bearing material, collect flow. See figure 32-25 for details.

**Figure 32-18** Depression spring, seepage, or filtration type

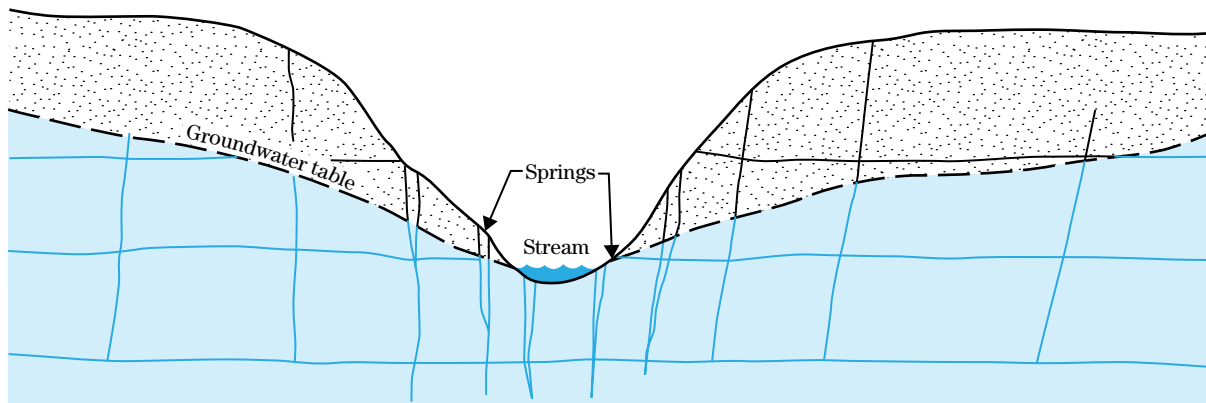
**Table 32-10** Characteristics of contact springs

<b>Location</b>	May occur on hillsides or in valleys or wherever the outcrop of an impermeable layer occurs beneath a water-bearing permeable layer (fig. 32-19)
<b>Type of opening</b>	Openings in sand or gravel are irregular, intergranular spaces. Openings in rocks are joints, fractures, or open bedding planes. Openings may be tubular in limestone, gypsum, and basalt
<b>Yield</b>	Volume of flow may range from less than one to several thousand gallons per minute, depending on the height and gradient of the water table, permeability fracturing or development of solution openings of the water-bearing material, volume of aquifer tributary to the spring, and conditions of water intake
<b>Type of flow</b>	Usually perennial for contact springs supplied by the area water table. If contact spring is supplied by a perched water table, the flow may be intermittent
<b>Quality of water</b>	Usually fair to excellent, but may be mineralized if water-bearing material is soluble
<b>Water temperature</b>	The temperature of the water will approximate the mean annual atmospheric temperature of the location with the same exceptions as noted under fracture and joint springs
<b>Features produced</b>	Travertine ( $\text{CaCO}_3$ ) may be deposited as described under Fracture and joint springs
<b>Method of development</b>	Remove obstructions to flow. Expose additional area of water-bearing material. Collect flow. See Development of springs for details

**Figure 32-19** Typical contact springs

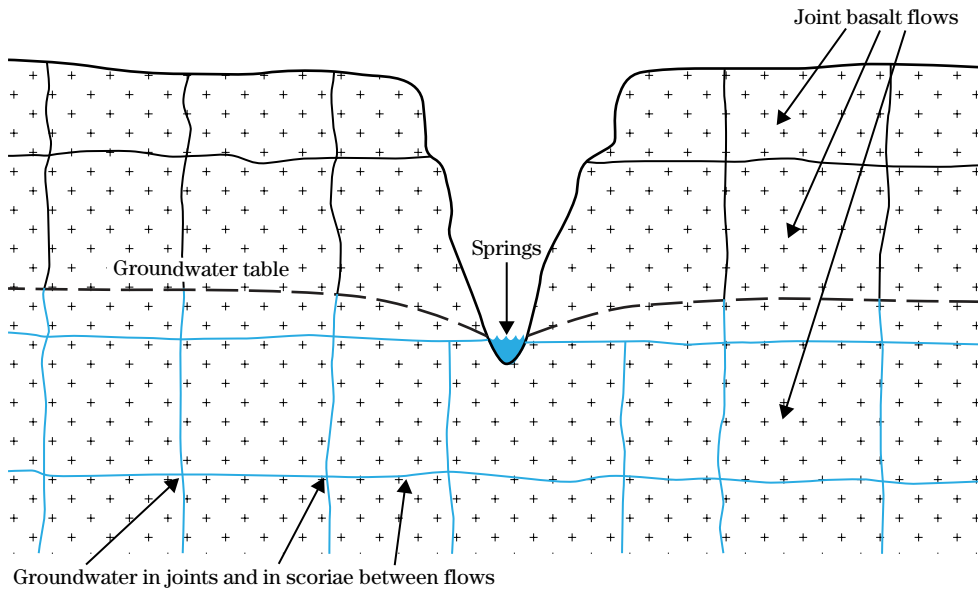
**Table 32-11** Characteristics of fracture, joint, and tubular springs

Location	On hillsides, in valleys, or wherever land surface is below the water table (figs. 32-20, 32-21, or 32-22)
Type of opening	Fractures and open bedding planes in all rocks, sometimes tubular openings in limestone, gypsum, and lava
Yield	Flow may range from less than one to hundreds of gallons per minute, depending on the extent of fractures, solution passages, or joint system tributary to the opening
Type of flow	Usually perennial; may fluctuate with precipitation if tributary area is small
Quality of water	Usually good to excellent. May be hard (contain $\text{CaCO}_3$ ) if spring issues from or percolates through limestone.
Water temperature	The temperature of the water will approximate the mean annual atmospheric temperature at location with exceptions as follows: if movement of water occurs through passages that are open to the circulation of air, cooling to as much as several degrees below mean annual temperature will occur; if water is not in contact with circulating air and the depth to the water table is several hundred feet, the water will be a few degrees (generally about $1^\circ$ for each 100 ft depth) warmer than the mean annual temperature. Buried igneous rock, if still hot, will raise the temperature of groundwater, producing hot springs
Features produced	If the water is warmer than the mean annual atmospheric temperature and has percolated through limestone on its way to the point of discharge, travertine ( $\text{CaCO}_3$ ) may be deposited around the spring opening. Water from other materials usually produces no surface features
Method of development	Remove obstructions to flow. Find other fractures which are seeping and clean them out. Collect flows. See Development of springs for details

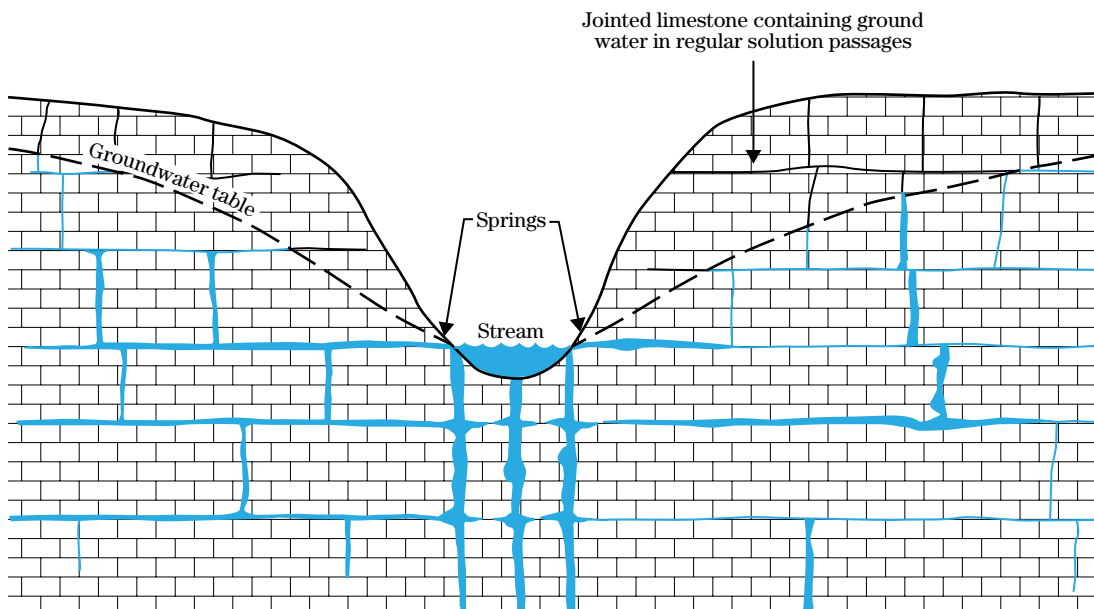
**Figure 32-20** Spring in jointed sandstone

Groundwater mainly in joints, fractures, and along bedding planes in sandstone

**Figure 32-21** Spring in jointed basalt

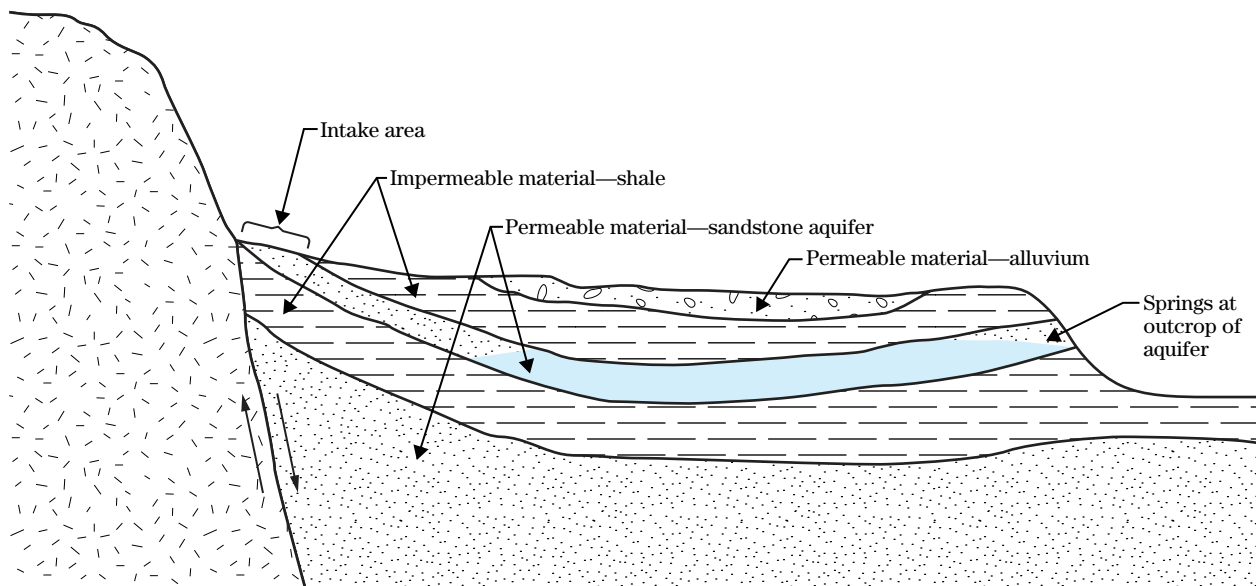


**Figure 32-22** Spring in jointed limestone



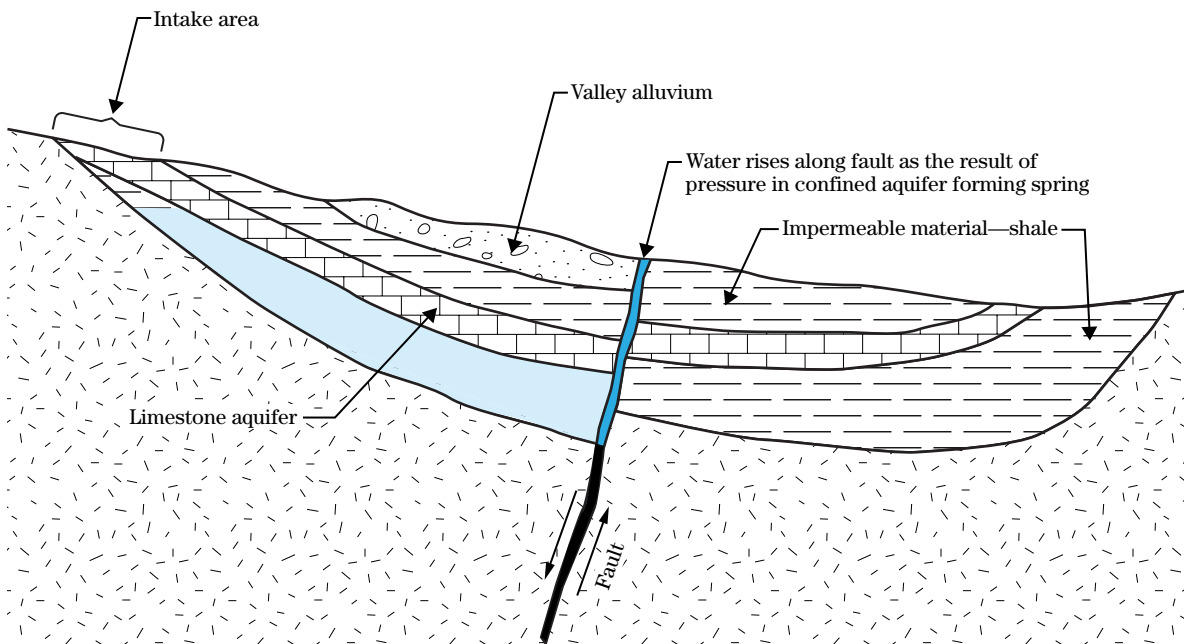
**Table 32-12** Characteristics of aquifer outcrop springs

Location	May occur in any topographic position along outcrop of aquifer (fig. 32-23)..
Type of opening	Depends on nature of water-bearing material. If aquifer is sandstone, water may seep from spaces between grains, fractures, or open bedding planes. If aquifer is limestone, water will issue from joints or tubular openings. May be sandstone, limestone, or jointed basalt.
Yield	Flow may range from a few to several thousand gallons per minute.
Type of flow	Perennial, usually constant. Quickly affected by wells drawing from same aquifer. May be affected by long continued drought.
Quality of water	Usually good to excellent. Water may be hard or mineralized (contain $\text{CaCO}_3$ ) if aquifer is limestone.
Water temperature	The temperature of the water will approximate the mean annual atmospheric temperature of the location unless the aquifer is deeply buried. If so, temperature will be a few degrees above the mean annual temperature (about $1^\circ$ for each 100 ft aquifer lies beneath the surface).
Features produced	If water is from a limestone aquifer and is warmer than the mean annual temperature, travertine ( $\text{CaCO}_3$ ) may be deposited.
Method of development	Remove obstructions to flow. Expose additional area of aquifer or if from joints or fractures, find other openings that are seeping and clean them out. Lower outlet elevation and improve drainage. Collect flow. See Development of springs for details.

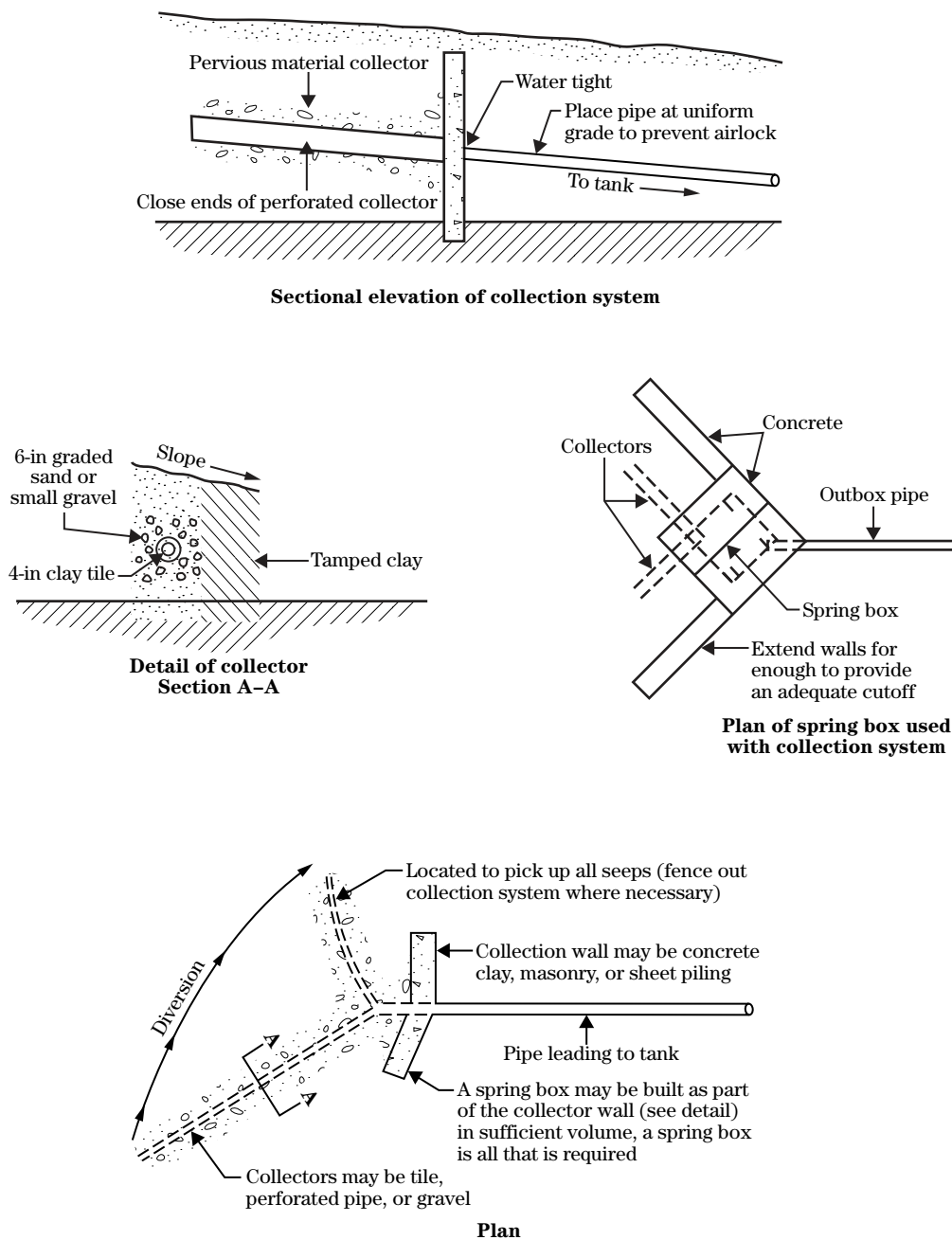
**Figure 32-23** Artesian spring at outcrop of aquifer

**Table 32-13** Characteristics of fault springs

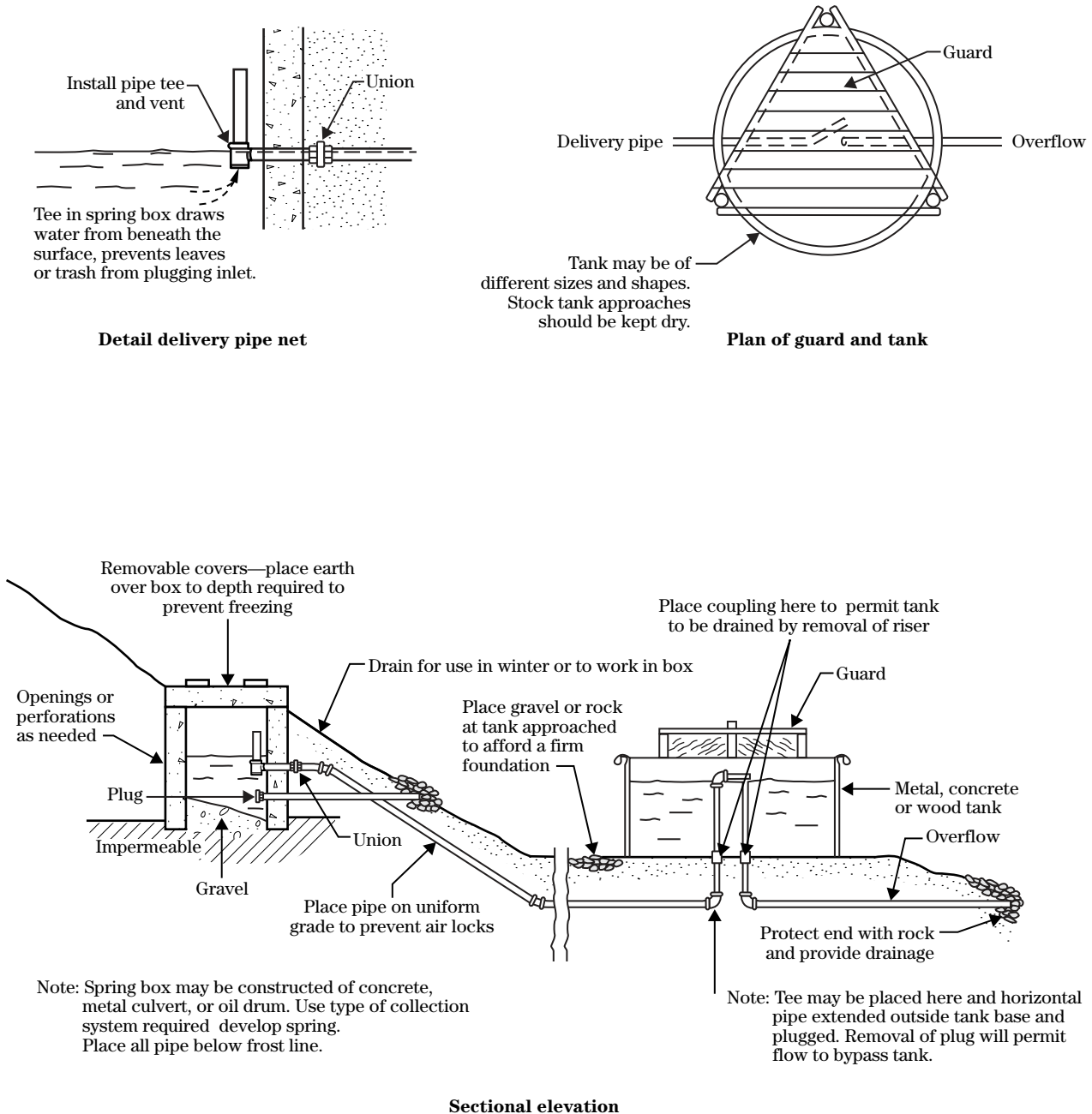
Location	May occur at any location along a fault or related fractures. See figure 32-24.
Type of opening	Depends on nature of material at land surface. If surface is alluvium, water issues from spaces between grains. If surface is rock, water issues from fractures. May be any kind of rock.
Yield	Volume of flow may range from a few to several thousand gallons per minute.
Type of flow	Perennial, constant, and only affected by long periods of drought. Quickly affected by pumping from wells drawing on the source aquifer.
Quality of water	Usually good to excellent. Water may be hard or mineralized (contain $\text{CaCO}_3$ ) if aquifer is limestone.
Water temperature	See Aquifer outcrop springs.
Features produced	See Aquifer outcrop springs.
Method of development	Remove obstructions to flow. Search for other fractures that are seeping and clean them out. Lower outlet elevation. Improve drainage. Collect flows. See Development of springs for details.

**Figure 32-24** Artesian spring occurring along a fault

**Figure 32-25** Spring collection system



**Figure 32-26** Spring box and pipe arrangement





of the spring and impermeable stratum would be less costly than a system of galleries along the bedding plane.

A storage tank is usually required—the size depends on the intended use of the water and the yield and dependability of the spring.

### (2) Removal of obstructions

Obstructions to flow may be deposits of travertine ( $\text{CaCO}_3$ ) or fine-grained materials (sand, silt, or clay) brought to the outlet by spring flow, or they may be slope wash materials deposited on the outlet by surface waters. Vegetation growing in or around the outlet may obstruct flow and will consume water.

If the spring water carries sediment to the opening, the sediment should be trapped. When a sump is used, it should be located below the spring so that the sediment will not build up over the outlet between periodic cleanings. The sump should be designed to facilitate cleaning by sluicing, if possible.

Ditches located to divert surface drainage away from the spring will prevent the clogging of outlets by slope wash material. If the collection of several small flows is planned, use covered galleries or drains to avoid cleaning and maintaining open ditches.

The flow of small springs can be reduced substantially by transpiration of phreatophytes. These phreatophytes can be eliminated by the use of chemicals or eradicated mechanically. Care must be exercised with either method. The chemicals used to eliminate the phreatophytes could contaminate the spring. Mechanical eradication may expose large areas of bare earth that could erode. The resulting sediment could impair the spring opening or downstream areas unless suitable vegetation is established.

### (3) Collection of flow

At some locations, collecting the flow at several openings, or seeping from an outcrop of water-bearing material, is the only means of development. Where water comes from fractures, the individual openings should be cleaned, and the water collected by means of a tile or perforated pipeline, or gravel-filled ditch “French drain” graded to a central sump or spring box. In collecting water seeping from permeable material, the ditch or tunnel should expose the length and thickness of the water-bearing zones. The excavation must extend sufficiently below the water-bearing zones to afford drainage.

### (4) Drainage of additional area of the water-bearing formation

The flow of depression and contact type springs can be increased by excavation, located to drain additional portions of the aquifer. Such excavation may be either by ditches or tunnels, depending on topography at the spring, and the characteristics of the water-bearing and underlying materials.

If the spring occurs in gently sloping or nearly level terrain, a ditch along the outcrop of the water-bearing material may be the most economical method. The ditch should be dug to intercept the maximum area of the water-bearing zone.

A tunnel or infiltration gallery may be the most practical method of developing depression or contact springs in steep, hilly terrain. See table 32–14 for tunnel locations in consolidated and unconsolidated material. Tunneling in unconsolidated and many consolidated deposits requires support of the roof and lining to prevent cave-ins.

**Table 32–14** Tunnel location

Aquifer material	Material underlying aquifer	Location of tunnel
Consolidated	Consolidated	In underlying material with top of tunnel exposing bottom of aquifer
Unconsolidated	Unconsolidated	In aquifer at contact with underlying material
Unconsolidated	Unconsolidated	In aquifer at contact with underlying material

### (5) Lowering outlet elevation

This method is effective in improving the flow of springs that are supplied by an extensive system of channels in rock or by a large volume of permeable water-bearing material, as in some artesian springs. By lowering the outlet elevation, added head of water is made available to increase flow at the spring. If the volume of groundwater tributary to the outlet is great, the lowering of the outlet elevation may produce a substantial and long-lasting increase in flow. If the volume of water tributary to the spring is limited, the increase in flow may be expected to be of short duration. A study of the source of supply should precede lowering the outlet.

### (6) Explosives

The use of explosives is not recommended because the shattering and dislocation of rock resulting from blasting may, by closure of a fracture or joint, cause the existing flow to cease or to be redirected to some other location.

### (7) Structures

Various types of structures and methods, including perforated or tile pipelines laid in gravel-filled ditches, drainage ditches back-filled with gravel or sand, infiltration galleries, or tunnels, may be used in the collection of groundwater for spring developments. Selection of the method should be influenced by conditions of spring occurrence such as topography, nature of the water-bearing material, type of flow openings, and volume of flow.

A spring box and pipeline are the most satisfactory means of delivering water to the point of use. The spring box or collecting basin should be located or designed so that water does not pond over the spring openings. Ponding over the spring openings reduces spring discharge and may cause seeps to change their path of flow.

Sketches of a typical spring collection system and a spring box and pipe arrangement are shown in figures 32-25 and 32-26. The collection system shown is suitable for development of a seepage or filtration type spring

#### (i) Collector

The collector may consist of clay tile or perforated pipe laid in graded small gravel (1/4 inch or less diameter) or graded sand as shown in figure 32-25. In figure

32-25, the detail of collector, section A-A, would be a section of a French drain if the clay tile were not installed in the gravel envelope.

In constructing a collector in permeable material, it is good practice to place an impervious barrier on the downhill side of the trench as shown. The barrier should extend down to impervious material to intercept the water and cause it to flow to the point of collection. Under some conditions, sand points may be driven into saturated material to serve as collectors.

In plan, the head-wall or cut-off is usually constructed as a large V with the apex downhill and the wing walls extending into the hill to prevent water from escaping. If concrete is used, the wall should be at least 6 inches thick. Masonry, sheet piling, or clay may also be used for the head wall, which should extend deep enough to prevent underflow.

#### (ii) Spring box

A spring box may be constructed in the apex of the V-shaped head wall as shown in figure 32-25. Use of a spring box provides a settling basin for sediment removal and facilitates maintenance of the development. If a spring box is used with a collector system as shown, the upstream wall should have openings located so that all the water collected can enter the box. Satisfactory spring boxes may be constructed of concrete, sections of large diameter pipe, or barrels. Wooden spring boxes deteriorate in a few years and are not satisfactory. For springs not requiring a collector system, the upstream wall of the box may be omitted. The spring box should have a tight-fitting cover, and the entire development should be covered with earth to a depth which will prevent freezing.

#### (iii) Delivery pipes

An important part of the spring development is the arrangement of the delivery and overflow pipe layout (fig. 32-26). The pipes may be steel, copper, or plastic. A pipe having a diameter of not less than 1 1/4 inches should be used where the grade is over 1 percent. Where the grade is between 0.5 percent and 1.0 percent, a pipe having a 1 1/2-inch or larger diameter is recommended. Grades under 0.5 percent require a 2-inch-diameter pipe as a minimum. Grades less than 0.2 percent are not recommended. When pipes smaller than recommended are used, they can become clogged and be difficult to clean. Cleaning may be facilitated by placing Ts or Ys with plugs at selected points in the pipeline.

The pipe should be laid on a positive grade. High spots usually create air locks, which may stop the flow. They also reduce the velocity of flow. Pipes should be laid below the frost line and covered to prevent freezing.

The pipe leaving the spring box should be placed at least 6 inches above the floor to provide a sediment trap. A water-tight connection must be made where the pipe leaves the spring box or goes through the cut-off wall. A union should be placed on the pipe outside the wall to permit easy removal of pipe section. A tee and vent pipe should be installed on the pipe within the spring box to reduce plugging from leaves or trash.

The pipe connection with the water tank may be accomplished in a number of ways. The practice of bringing the pipe under the tank and vertically through the bottom is usually considered the most desirable where the tank is to be used during freezing weather. It has also been found beneficial to have the inlet and outlet pipes fairly close together near the center of the tank. Even though the water freezes around the edge of the tank, it will tend to stay open at the center depending on the rate of inflow. In cold climates, tanks should be designed to be watertight when the surface is frozen to a reasonable depth. Figure 32-26 illustrates a good method of bringing the delivery pipe into the tank and of bypassing the flow.

#### *(iv) Hydraulic rams*

If it is necessary to deliver water from a spring development to a higher elevation than the outlet of the spring, a hydraulic ram can be used.

A hydraulic ram is an automatic pump operated by water power. It uses the power developed by the surge of a quantity of falling water to force a much lesser amount to an elevation above the source of supply. Figure 32-27 is a sketch of a typical ram installation and a diagrammatic sketch of a ram.

Briefly, this is how a hydraulic ram works: water from the supply flows down the drive pipe to the ram, developing a certain power due to its weight and movement. It flows through the outside valve of the ram until it reaches a certain velocity, whereon the valve closes. The column of water continues on through the inside valve into the air chamber. When the pressure in the air chamber equalizes and overcomes the power in the column of water, a rebound takes place, which closes the inside valve and opens the outside valve, allowing

the water to start flowing again, and the entire process is repeated. It is repeated from 25 to 100 times per minute, building up pressure in the air chamber, which in turn forces water through the delivery pipe to the place where it can be used.

The volume of water that a ram can pump depends on the fall between the source of supply and the ram, height the water is to be raised from the ram to the outlet, and quantity of water available. When the water supply is limited, a ram is selected that can operate with the minimum quantity of water available. Where water supply is abundant, the size of the hydraulic ram is determined by the quantity of water needed per day. Manufacturers build rams that operate successfully on flows of 1 ½ gallons per minute or more, when operating under a head of not less than 2.0 feet.

A formula for estimating the number of gallons of water delivered per hour from a hydraulic ram to a given point is:

$$D = \frac{V F 40}{E} \quad (\text{eq. 32-24})$$

where:

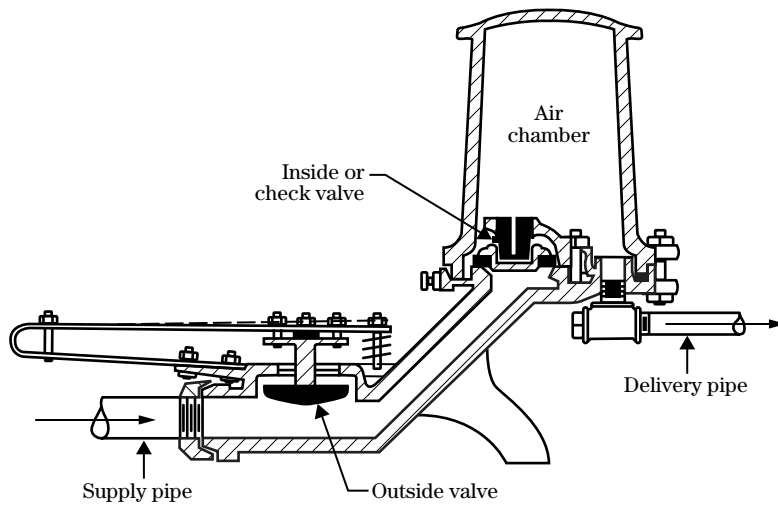
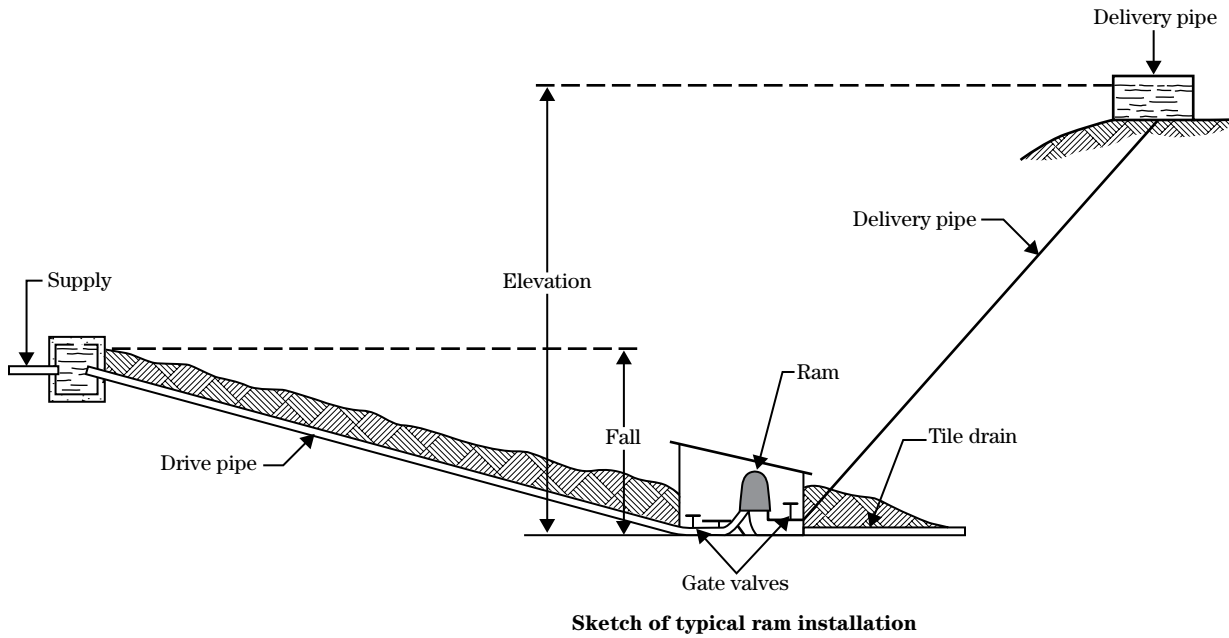
- D = gallons per hour that the ram will deliver
- V = gallons per minute of supply water available
- F = fall in feet
- E = vertical elevation in feet that water is to be raised

Similar information can be obtained by referring to table 32-15.

To determine the feasibility of using a ram, the following information should be collected:

- number of gallons per minute which the spring, artesian well, or stream will deliver
- number of gallons per 24-hour day desired from the ram
- available fall in feet from the source of water to the ram
- elevation to which water is to be raised above the ram
- pipeline distance from ram to point of discharge

**Figure 32-27** Hydraulic ram



**Diagrammatic sketch of ram**

- pipeline distance from the source of water to the ram

### (v) Dugouts

Dugouts are excavations below the water table usually made with dragline equipment. They need to extend into the zone of saturation deep enough to allow for an abnormally low water table during dry periods to make certain that the supply is permanent. They are generally located in valleys of stream systems, but may be developed wherever the water table is permanently close to the land surface. Dugouts are favored kinds of water developments because they are easy to construct, are automatic water holes, usually require very little attention, and are economical.

The unfavorable aspects of a dugout are sanitation, death traps where foundation materials are so soft that animals mire and get stuck in the mud, not suitable for cold climate winter use because of ice, and sedimentation. The sanitary hazards pertain to bacterial contamination and lack of drainage away from the water supply. Flood waters may do some flushing of bacteria, but they also introduce loose muds that contribute to miring and adding to the hazard of trapping animals.

In areas of shallow groundwater where dugouts are usually constructed, a shallow well is a more satisfactory livestock watering facility. If electric service is available, a watering tank with a float switch to acti-

vate an electrically operated pump provides a more desirable and sanitary water supply. If electric power is not available at the site, a windmill can provide a source of power for a pump. In this case, the tank should have an overflow pipe that will dispose of excess water some distance away to prevent a mud hole from developing around the tank.

### (8) Protection

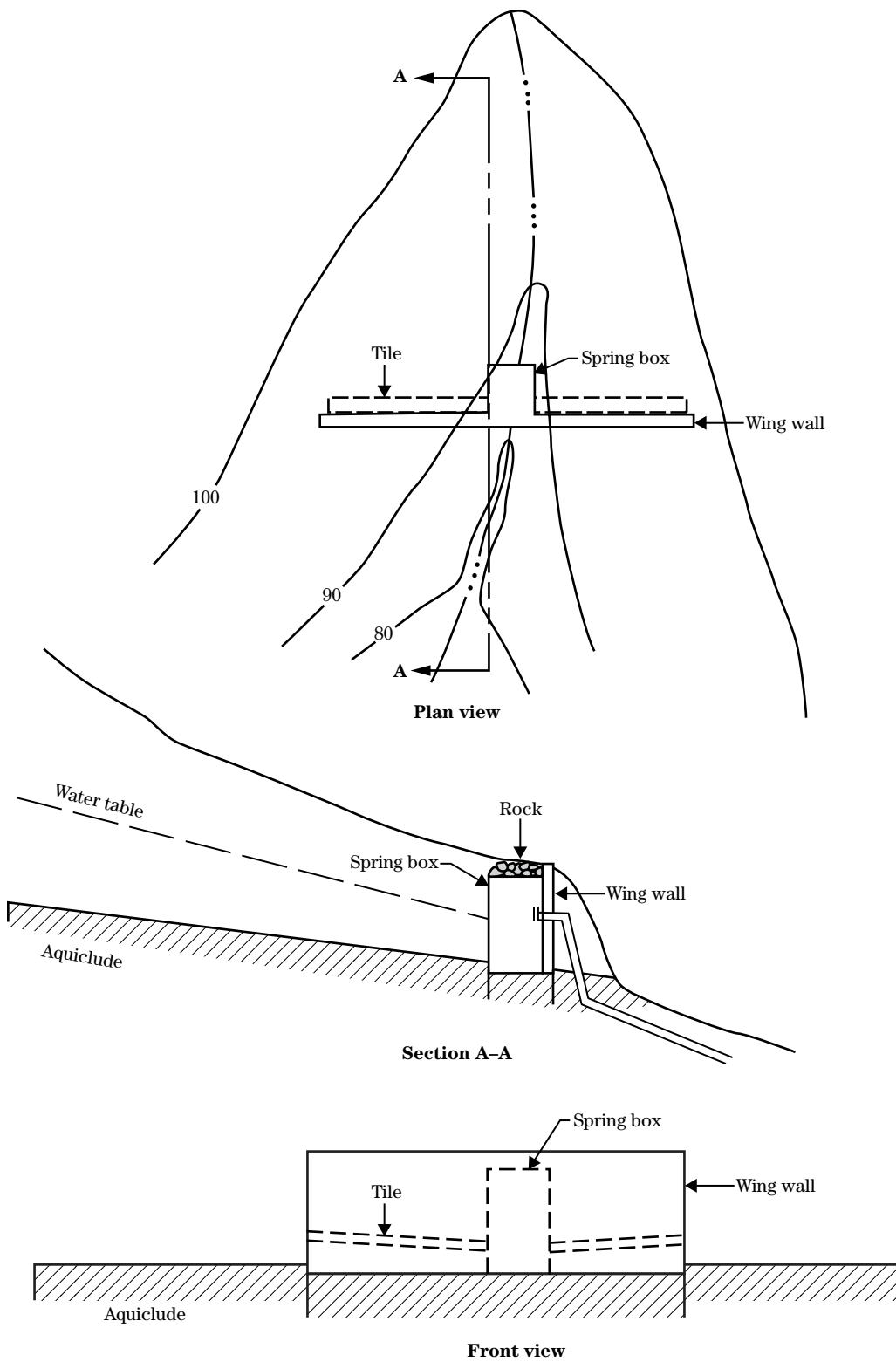
Springs frequently occur at locations that are susceptible to flooding. Protection should be afforded to the spring and its appurtenant structures to permit use without continual maintenance. Diversions properly located will afford protection in many instances.

The spring itself may be developed so that flood flows passing over the top will not cause damage. A concrete retaining or wing wall properly constructed and located will prevent channel degradation and dewatering of the spring aquifer. A spring box with a steel or concrete lid placed below the top of the concrete wing wall and protected by a debris basin of rock and gravel may be adequate flood protection. The pipeline should be extended far enough down-valley to place the watering tank above flood crests. This type of development is illustrated in figure 32-28.

**Table 32-15** Gallons of water lifted by hydraulic ram per gallon received from source (from Farmers' Bulletin No. 1978, Safe Water for the Farm)

Fall in feet	Height delivered (in feet)							
	12	18	24	30	36	48	60	72
2	0.10	—	—	—	—	—	—	—
4	0.18	0.15	0.10	—	—	—	—	—
6	0.33	0.20	0.17	0.13	0.10	—	—	—
8	0.42	0.28	0.20	0.17	0.15	0.10	—	—
10	0.54	0.36	0.27	0.22	0.18	0.14	0.10	—
12	0.67	0.44	0.33	0.26	0.22	0.16	0.13	0.10

**Figure 32-28** Spring development in stream channel



## 631.3202 References

- American Society for Testing and Materials. 1995. ASTM F-480, Standard specification for thermoplastic well casing pipe and couplings made in standard dimension ratios (SDR), SCH 40 and SCH 80.
- American Society for Testing and Materials. 1998. ASTM A-139, Standard specification for electric-fusion (Arc)-welded steel pipe (NPS 4 and over).
- American Water Works Association. 1998. AWWA standard for water wells. Denver, CO. 73 pp.
- Driscoll, F.G. 1986. Groundwater and wells. Johnson Division. St. Paul, MN. 1089 pp.
- Fetter, C.W., Jr. 1980. Applied hydrogeology. Charles E. Merrill Publishing Company. Columbus, OH.
- Freeze, R.A., and J.A. Cherry. 1979. Groundwater. Prentice-Hall, Inc. Englewood Cliffs, NJ.
- Johnson, E.E. 1955a. The corrosion and incrustation of well screens: Bull. 834 (rev.). St. Paul, MN.
- Johnson, E.E. 1955b. The yield of water wells: Bull. 1238 (rev.). St. Paul, MN.
- Johnson, E.E. 1959. The principles and practical methods of developing water wells. Bull. 1033 (rev.). St. Paul, MN.
- Johnson, E.E. 1975. Groundwater and wells. Johnson Division. UOP, Inc. St. Paul, MN.
- Kruse, G. 1960. Selection of gravel packs for wells in unconsolidated aquifers. Colorado State University Tech. Bull. 66. Fort Collins, CO.
- National Ground Water Association and Plastic Pipe Institute. 1990. Manual on the selection and installation of thermoplastic water well casing. National Ground Water Association. Westerville, OH, and Plastic Pipe Institute, New York, NY. 64 pp.
- Roscoe Moss Company. 1990. Handbook of ground water development. Los Angeles, CA. John Wiley and Sons. New York, NY. 493 pp.
- Roscoe Moss Company. 1993. Guide to water well casing and screen selection. Los Angeles, CA. 76 pp.
- Todd, D.K. 1959. Groundwater hydrology. John Wiley and Sons, Inc. New York, NY.
- U.S. Bureau of Reclamation. 1964. Ground-water engineering techniques and standards. Denver, CO.
- U.S. Bureau of Reclamation. 1998. Earth Manual, Third Edition, Earth Sciences and Research Laboratory, Geotechnical Research Technical Service Center. Denver, CO.
- U.S. Bureau of Reclamation. 1998. Engineering Geology Field Manual. Denver, CO.
- U.S. Bureau of Reclamation. 2001. Water Measurement Manual, in cooperation with USDA-ARS and USDA-NRCS. Superintendent of Documents. U.S. Government Printing Office, Washington, DC. ([http://www.usbr.gov/pmts/hydraulics\\_lab/pubs/wmm/index.htm](http://www.usbr.gov/pmts/hydraulics_lab/pubs/wmm/index.htm))
- U.S. Department of Agriculture. 1948. Safe water for the farm. Farmers' Bulletin No. 1978. Washington, DC.
- U.S. Department of Agriculture, Soil Conservation Service. 1953. Farm Planner's Engineering Handbook for the Upper Mississippi Region, Agricultural Handbook No. 57. Washington, DC.