



Online Continuing Education for Professional Engineers
Since 2009

Landfill Gas Collection and Treatment Systems

PDH Credits:

8 PDH

Course No.:

LAN101

Publication Source:

US Corp of Engineers
(Unified Facilities Criteria)
“Landfill Gas Collection and Treatment Systems”

EM 200-1-22

Release Date:

April 2013

DISCLAIMER:

All course materials available on this website are not to be construed as a representation or warranty on the part of Online-PDH, or other persons and/or organizations named herein. All course literature is for reference purposes only, and should not be used as a substitute for competent, professional engineering council. Use or application of any information herein, should be done so at the discretion of a licensed professional engineer in that given field of expertise. Any person(s) making use of this information, herein, does so at their own risk and assumes any and all liabilities arising therefrom.

EM 200-1-22
30 April 2013



US Army Corps
of Engineers®

ENVIRONMENTAL QUALITY

LANDFILL GAS COLLECTION AND TREATMENT SYSTEMS

ENGINEER MANUAL

AVAILABILITY

Electronic copies of this and other U.S. Army Corps of Engineers (USACE) publications are available on the Internet at <http://140.194.76.129/publications/>. This site is the only repository for all official USACE engineer regulations, circulars, manuals, and other documents originating from HQUSACE. Publications are provided in portable document format (PDF).

This document is intended solely as guidance. The statutory provisions and promulgated regulations described in this document contain legally binding requirements. This document is not a legally enforceable regulation itself, nor does it alter or substitute for those legal provisions and regulations it describes. Thus, it does not impose any legally binding requirements. This guidance does not confer legal rights or impose legal obligations upon any member of the public.

While every effort has been made to ensure the accuracy of the discussion in this document, the obligations of the regulated community are determined by statutes, regulations, or other legally binding requirements. In the event of a conflict between the discussion in this document and any applicable statute or regulation, this document would not be controlling.

This document may not apply to a particular situation based upon site-specific circumstances. USACE retains the discretion to adopt approaches on a case-by-case basis that differ from those described in this guidance where appropriate and legally consistent.

This document may be revised periodically without public notice.

DEPARTMENT OF THE ARMY
U.S. Army Corps of Engineers
Washington, DC 20314-1000

EM 200-1-22

CEMP-CE

Manual
No. 200-1-22

30 April 2013

Environmental Quality
LANDFILL GAS COLLECTION AND TREATMENT SYSTEMS

1. Purpose and Scope. This Engineering Manual (EM) establishes criteria and guidance for landfill gas collection and treatment systems. The foundation of Corps of Engineers environmental work is the Environmental Operating Principles as specified in ER 200-1-5. These seven tenets serve as guides and must be applied in all Corps business lines as we strive to achieve a sustainable environment.
2. Applicability. This EM applies to HQUSACE elements, major subordinate commands (MSC), districts, and field operating activities (FOA) with responsibilities for landfill gas collection and treatment systems.
3. Distribution Statement. Approved for public release and unlimited distribution.
4. Background. This EM provides information about the design of systems to monitor, collect, transport, and treat gas from municipal, industrial and hazardous waste landfills. The EM describes various landfill gas (LFG) emission control techniques and presents design procedures relative to each. The following topics are discussed in this EM:
 - a. Reasons for LFG control;
 - b. Theory of LFG emissions;
 - c. LFG and condensate characteristics;
 - d. Estimation of LFG production;
 - e. LFG collection and treatment design considerations;
 - f. Operation and maintenance (O&M) requirements; and
 - g. Regulatory requirements.

FOR THE COMMANDER:

2 Appendices
(See Table of Contents)

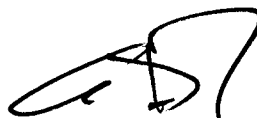

C. DAVID TURNER
Colonel, Corps of Engineers
Chief of Staff

CEMP-CE

Manual
No. 200-1-22

30 April 2013

Environmental Quality
LANDFILL GAS COLLECTION AND TREATMENT SYSTEMS

TABLE OF CONTENTS

	Paragraph	Page
Chapter 1. Introduction		
Purpose and Scope	1.1	1-1
Applicability	1.2	1-1
Distribution Statement.....	1.3	1-1
References.....	1.4	1-1
Background.....	1.5	1-1
Reasons for LFG Control.....	1.5.1	1-1
LFG Generation Mechanisms.....	1.5.2	1-2
Biological Decomposition.....	1.5.3	1-3
Chemical Reactions.....	1.5.4	1-4
Factors Affecting LFG Generation.....	1.6	1-5
Waste Composition.....	1.6.1	1-5
Temperature.....	1.6.2	1-5
Moisture.....	1.6.3	1-6
pH.....	1.6.4	1-6
Atmospheric Conditions.....	1.6.5	1-6
Density of the Waste.....	1.6.6	1-6
Age of Waste.....	1.6.7	1-7
Transport Mechanisms.....	1.7	1-7
Diffusion.....	1.7.1	1-7
Advection.....	1.7.2	1-8
Factors Affecting LFG Transport Mechanisms.....	1.8	1-8
Permeability.....	1.8.1	1-8
Geologic Conditions.....	1.8.2	1-8
Depth to Ground Water.....	1.8.3	1-8
Man-Made Features.....	1.8.4	1-9
Landfill Cover and Liner Systems.....	1.8.5	1-9
Barometric Pressure.....	1.8.6	1-9
LFG Characteristics.....	1.9	1-10
Density and Viscosity.....	1.9.1	1-10
Heat Value Content.....	1.9.2	1-10
Non-Methane Organic Compounds.....	1.9.3	1-10
Water Vapor.....	1.9.4	1-11
Others.....	1.9.5	1-11
LFG Condensate.....	1.10	1-11
Source of LFG Condensate.....	1.10.1	1-11
Condensate Quality.....	1.10.2	1-12

	Paragraph	Page
Chapter 2. Requirements		
Site Characterization and Estimation of Landfill Gas Emissions	2.1	2-1
General.....	2.1.1	2-1
Landfill Characteristics	2.1.2	2-1
Hydrogeologic Conditions	2.1.3	2-1
Ambient Air Quality	2.1.4	2-2
LFG Monitoring Probes.....	2.1.5	2-3
Monitoring LFG in Structures	2.1.6	2-3
Soil Gas Surveys.....	2.1.7	2-3
Pump Tests	2.1.8	2-6
Analytical Methods	2.1.9	2-6
Data Analysis	2.1.10	2-7
Estimation of LFG Production and Emissions	2.2	2-8
LandGEM	2.2.1	2-8
Theoretical Models.....	2.2.2	2-10
Regression Model	2.2.3	2-11
Chapter 3. Design of Landfill Gas Collection Systems		
General.....	3.1	3-1
Methods of LFG Collection	3.2	3-1
Wells	3.2.1	3-1
Blanket Collection Systems	3.2.2	3-4
Trenches	3.2.3	3-6
LFG Monitoring Probes.....	3.3	3-8
General.....	3.3.1	3-8
Design Considerations.....	3.3.2	3-9
Monitoring Devices for Structures.....	3.3.3	3-9
Cover Penetrations	3.4	3-10
General.....	3.4.1	3-10
Design Considerations.....	3.4.2	3-10
Header Piping	3.5	3-10
General.....	3.5.1	3-10
Design Considerations.....	3.5.2	3-11
Valves.....	3.6	3-12
General.....	3.6.1	3-12
Design Considerations.....	3.6.2	3-13
Well Heads.....	3.7	3-14
Flow Rate Measurement.....	3.7.1	3-14
Orifice Plate.....	3.7.2	3-15
Pitot Tube	3.7.3	3-15
Header System Layout.....	3.8	3-16
General.....	3.8.1	3-16
Design Considerations.....	3.8.2	3-17
Subsurface Pressure Drop Losses.....	3.8.3	3-18

	Paragraph	Page
Piping Frictional Pressure Drop Losses	3.8.4	3-18
Pressure Drop Losses from Valves and Fittings	3.8.5	3-19
Pressure Drop Losses at Flare Station	3.8.6	3-19
System Analyses	3.8.7	3-19
Simplified Pneumatic Design Procedure	3.8.8	3-20
Condensate Collection	3.9	3-26
General	3.9.1	3-26
Design Considerations	3.9.2	3-27
Design Procedures for Passive Collection Systems	3.10	3-30
General	3.10.1	3-30
Passive Blanket Collection Systems	3.10.2	3-31
Design Considerations for Passive Well Collection Systems	3.10.3	3-32
Design Procedures for Active Well Collection Systems	3.11	3-32
General	3.11.1	3-32
Other Design Considerations	3.11.2	3-35

Chapter 4. Design of Landfill Gas Treatment Systems

Introduction	4.1	4-1
Structure	4.2	4-1
Blower	4.3	4-1
Centrifugal Blowers	4.3.1	4-2
Rotary Lobe Blowers	4.3.2	4-2
Blower Summary	4.3.3	4-2
LFG Energy Recovery Systems	4.4	4-3
Recovery Options	4.4.1	4-3
USEPA LFG to Energy Support	4.4.2	4-4
Ongoing Army LFG to Energy Projects	4.4.3	4-5
Flares	4.5	4-6
Open-Flame Flare	4.5.1	4-6
Enclosed Flares	4.5.2	4-6
Flare Design Criteria	4.5.3	4-7
Flare Operating Criteria	4.5.4	4-9
Condensate Collection Equipment	4.6	4-9
Auxiliary Fuel	4.7	4-10
Flame Arrestor	4.8	4-10
Flow Metering	4.9	4-10
Piping and Valves	4.10	4-10
Electrical Design Requirements	4.11	4-10
General	4.11.1	4-10
Electric Controls	4.11.2	4-11
Automation of Controls	4.12	4-11
Control Elements	4.12.1	4-11
Degree of Automation	4.12.2	4-14
Special Instrumentation Requirements	4.12.3	4-14
Variable Frequency Drive Motors	4.12.4	4-15
Other Design Considerations	4.13	4-15
Site Working Areas	4.13.1	4-15
Utilities	4.13.2	4-15

	Paragraph	Page
Emergency Power	4.13.3	4-15
Water	4.13.4	4-15
Fencing	4.13.5	4-15
Lighting	4.13.6	4-16
Labor Requirements	4.13.7	4-16
System Safety	4.13.8	4-16

Chapter 5. Operation and Maintenance for Landfill Gas Collection Systems

Introduction	5.1	5-1
Extraction Wells	5.2	5-1
Composition of Air	5.2.1	5-1
Monitoring	5.2.2	5-2
Balancing Techniques	5.2.3	5-2
Primary Well Field Monitoring	5.2.4	5-3
Perimeter LFG Migration Control	5.2.5	5-3
Barometric Pressure	5.2.6	5-3
Leachate Blockage of Extraction Wells	5.2.7	5-3
Landfill Fires	5.2.8	5-4
Vertical Profiling	5.2.9	5-5
Inspection and Maintenance	5.2.10	5-5
Gas Monitoring Probes	5.3	5-5
Monitoring Procedures	5.3.1	5-5
In-probe Acceptable Levels	5.3.2	5-6
Monitoring Frequency	5.3.3	5-6
Enclosed Structure Monitoring	5.3.4	5-6
Surface Emission Monitoring	5.3.5	5-7
LFG Monitoring Equipment	5.4	5-7
Combustible Gas Indicator/Thermal Conductivity Method	5.4.1	5-8
Flame Ionization Detector (FID)/Organic Vapor Analyzer (OVA)	5.4.2	5-9
Infra-Red (IR) Analyzer	5.4.3	5-9
Colorimetric Indicator Tubes	5.4.4	5-10
Condensate Collection and Treatment	5.5	5-11
Treatment	5.5.1	5-11
Injection/Recirculation	5.5.2	5-11
Aspiration into the LFG Flare	5.5.3	5-11
Summary	5.5.4	5-12
Flare Station	5.6	5-12
Blower	5.6.1	5-12
Flame Arrestor	5.6.2	5-13
Flare	5.6.3	5-13
Maintenance Requirements	5.7	5-14
Routine Maintenance	5.7.1	5-14
Non-Routine Maintenance	5.7.2	5-15
Emergency Services	5.7.3	5-15
Equipment Calibration	5.7.4	5-15
System Adjustments Based on Monitoring Data	5.7.5	5-15
Record Keeping and Contingency Plan	5.8	5-15

Chapter 6. Regulatory Requirements

Introduction	6.1	6-1
Summary of Applicable Regulations	6.2	6-1
Resource Conservation and Recovery Act Regulations	6.3	6-2
Clean Air Act Regulations	6.4	6-2
Clean Water Act Regulations	6.5	6-3
State and Local Regulations.....	6.6	6-4
Appendix A. References		A-1
Appendix B. Landfill Gas Collection System Calculations.....		B-1

List of Figures

	Page
Figure 1.1 Landfill Gas Composition.....	1-5
Figure 2-1 Data Gathering and Decision-Making Flow Chart for the Evaluation of LFG Emissions.....	2-2
Figure 3.1 Typical LFG Extraction Well.....	3-4
Figure 3-2 Passive LFG Vent Well.....	3-5
Figure 3-3 LFG Collection Blanket.....	3-6
Figure 3.4 Perimeter Collection Trench.....	3-7
Figure 3.5 Horizontal Trench Collection System.....	3-8
Figure 3.6 Orifice Plate Flow Measurement Device.....	3-15
Figure 3.7 Pitot Tube Measurement Device.....	3-16
Figure 3.8 Header Layout Options.....	3-17
Figure 3.9 Typical Pneumatic Analysis.....	3-20
Figure 3.10 Typical Extraction Well Layout.....	3-35
Figure 4.1 Enclosed Flare Schematic.....	4-7
Figure 4.2 Typical Piping and Instrumentation Diagram (P&ID) for a Blower/Enclosed Flare Station.....	4-12
Figure B.1 Plan View of the Site.....	B-2
Figure B.2 Landfill Gas Piping Flow Diagram.....	B-8
Figure B.3 Piping Head Loss Diagram.....	B-11
Figure B.4 Discharge Pressure Diagram.....	B-12

List of Tables

	Page
Table 1-1 Pressure Conversion Factors.....	1-2
Table 1-2 Density of the Waste.....	1-7
Table 1-3 LFG Characteristics.....	1-10
Table 1-4 Typical Values for Gas Density and Viscosity at 0°C and Atmospheric Pressure.....	1-11
Table 1-5 Organic Contaminants.....	1-12
Table 2-1 Important Parameters that Affect Off-Site Migration of LFG.....	2-2
Table 3-1 LFG Generation.....	3-36
Table 4-1 Blower Type Comparison.....	4-2
Table B-1 Piping Head Loss Calculations.....	B-9
Table B-2 Blower Discharge Pressure Calculations.....	B-13

CHAPTER 1 Introduction

1.1. Purpose and Scope. This Engineering Manual (EM) establishes criteria and guidance for landfill gas (LFG) collection and treatment systems. The foundation of Corps of Engineers environmental work is the Environmental Operating Principles as specified in ER 200-1-5. These seven tenets serve as guides and must be applied in all Corps business lines as we strive to achieve a sustainable environment.

1.2. Applicability. This EM applies to HQUSACE elements, major subordinate commands (MSC), districts, and field operating activities (FOA) with responsibilities for LFG collection and treatment systems.

1.3. Distribution Statement. Approved for public release; distribution unlimited.

1.4. References. Appendix A contains a list of references used in this EM.

1.5. Background. This EM provides information about the design of systems to monitor, collect, transport, and treat LFG from municipal, industrial and hazardous waste landfills. The EM describes various landfill LFG emission control techniques and presents design procedures relative to each. The following topics are discussed in this EM:

- a. Reasons for LFG control;
- b. LFG generation mechanisms;
- c. LFG and condensate characteristics;
- d. Estimation of LFG production and emissions;
- e. LFG collection and treatment design considerations;
- f. Operation and maintenance (O&M) requirements for LFG collection and treatment systems; and
- g. Regulatory requirements.

1.5.1. Reasons for LFG Control. The following is a list of common reasons for controlling the LFG produced by a landfill:

- a. Prevent air pollution and comply with regulatory air emission criteria;
- b. Reduce hazards due to off-site migration;
- c. Prevent damage to the landfill cover slope stability;
- d. Odor control;
- e. Energy recovery; and

- f. Prevent vegetation distress.

1.5.2. LFG Generation Mechanisms. LFG is produced by the biological decomposition of general solid waste refuse and other organic materials disposed of in the landfill. LFG production typically begins within a year of waste placement, and may continue up to 50 years after landfill closure, with peak LFG production for any given disposal cell occurring within the first or second year of waste placement. The total LFG production rate increases as more waste is added to the landfill. Reported LFG production rates vary from 0.0007 to 0.080 cubic meters of LFG per kilogram of waste burial per year (USEPA, 2005a).

LFG emissions are governed by gas-generation mechanisms and gas-transport mechanisms. The following paragraphs describe these mechanisms and the major factors influencing LFG generation and transport. The three primary causes of LFG generation are volatilization, biological decomposition, and chemical reactions.

1.5.2.1. Volatilization. Volatilization is due to the change of chemical phase equilibrium that exists within the landfill. Organic compounds in the landfill volatilize until the equilibrium vapor concentration is reached. This process is accelerated when biological activity increases the temperature of the waste mass. The rate at which compounds volatilize depends on their physical and chemical properties. Some of these properties are discussed in the following paragraphs.

1.5.2.2. Vapor Pressure. Vapor pressure quantifies the tendency of a pure liquid compound to partition to the vapor phase. Liquid molecules that possess sufficient kinetic energy are projected out of the main body of a liquid at its free surface and pass into vapor. The pressure exerted by this vapor is known as the vapor pressure. The vapor pressure of water at 20°C (68°F) is 2.34 kN/m² (0.339 psi). Pressure conversion factors are given in Table 1-1.

10 ³ N/m ²	=	1 kPa
1 psi	=	6.895 kPa
12 inches of water (at 4°C)	=	0.433 psi
1 inches of water (at 4°C)	=	1.87 mm Hg
29.92 inches of Hg	=	1 Atmosphere

1.5.2.3. Henry's Law Constant. Henry's Law determines the extent of volatilization of a contaminant dissolved in water. Henry's Law states: The amount of any LFG that will dissolve in a given volume of liquid, at constant temperature, is directly proportional to the pressure that the gas exerts above the liquid. Henry's Law is presented in the formula:

$$P_A = H_A \times X_A$$

where

P_A = partial pressure of compound A in the vapor phase

H_A = Henry's constant of compound A

X_A = mole fraction of compound A in liquid phase in equilibrium with the vapor phase.

Henry's constant quantifies the tendency for a volatile in landfill leachate to partition to the vapor phase. This constant is temperature-dependent, increasing with increasing temperature. Estimates of vapor pressure and Henry's constant for numerous organic compounds are shown in EM 200-1-18, "Soil Vapor Extraction and Bioventing". Additional information on Henry's constant can be found in DG 1110-1-3 "Air Stripping".

1.5.3. Biological Decomposition. Sanitary landfills produce large quantities of LFG, with the major components being methane and carbon dioxide. LFG generation occurs as a result of two conditions (aerobic and anaerobic decomposition) and can be divided into three distinct phases; however, it is important to understand that there will be both aerobic and anaerobic degradation occurring at the same time.

1.5.3.1. Phase 1—Aerobic Decomposition.

1.5.3.1.1. During the aerobic decomposition phase, microorganisms slowly degrade the complex organic portions of the waste using the oxygen trapped during the landfilling process to form simpler organic compounds, carbon dioxide, and water. Aerobic decomposition begins shortly after the waste is placed in the landfill, and continues until all of the entrained oxygen is depleted from the voids and from within the organic waste. Aerobic bacteria produce a LFG characterized by high temperatures, high carbon dioxide content (30 percent), and low methane content (2 to 5 percent). Interior landfill temperatures can run between 90 and 120 °F

1.5.3.1.2. Aerobic decomposition within the landfill typically lasts for several months; however, due to air exchange between the atmosphere and the landfill, there may always be some aerobic degradation occurring at the edges of the waste. Aerobic degradation generally degrades many of the larger polymers such as starches, cellulose, lignins, proteins, and fats into smaller, more available oligomers (polymer consisting of 2 to 4 monomers). These oligomers can then be further degraded into dimers (molecules consisting of two identical simpler molecules) and monomers such as sugars, peptides, amino acids, long-chain fatty acids, glycerol and eventually organic acids. These less complex products of aerobic degradation are more readily degraded anaerobically than the larger polymers.

1.5.3.2. Phase 2—Anaerobic Decomposition. Anaerobic decomposition occurs in two distinct phases. When all of the entrained oxygen is depleted from the waste, the waste decomposition changes from aerobic to anaerobic and two new groups of bacteria emerge which thrive in anaerobic environments. Facultative microbes convert the simple monomers into mixed acid products along with hydrogen and carbon dioxide. Anaerobic bacteria convert the mixed volatile organic acids (e.g., formic, acetic, propionic and butyric acids), aldehydes and ketones into primarily acetic acid and hydrogen. These organic acids reduce the pH, which increases the solubility of some organics and inorganics, increasing the concentration of dissolved solids in the leachate. Methane production can be limited during this stage, since the low pH (5 to 6) is somewhat toxic to methanogenic (methane-producing) bacteria.

1.5.3.3. Phase 3—Anaerobic Decomposition.

1.5.3.3.1. In the next phase of decomposition, methane producing bacteria utilize carbon dioxide, hydrogen, and inorganic acids to form methane and other products. During this stage of anaerobic decomposition, the methanogenic bacteria become more prominent. These methanogens degrade the volatile acids, primarily acetic acid and use hydrogen to generate methane and carbon dioxide. This degradation results in a more neutral pH (7 to 8) as the organic acids are consumed. A decrease in chemical oxygen demand (COD) and dissolved solids concentration within the leachate also occurs.

1.5.3.3.2. Phase 3 of the decomposition process is characterized by lower temperatures, high carbon dioxide concentrations (40% to 48%), and significantly higher methane concentrations (45% to 57%). Anaerobic decomposition will continue until all of the volatile organic acids are depleted or until oxygen is reintroduced into the waste. Figure 1.1 shows LFG composition trends versus time for the aerobic and anaerobic decomposition of landfill refuse.

1.5.4. Chemical Reactions. Chemical reactions between materials in the waste can release LFG. Most of these potential reactions are buffered by the presence of water. However, unpredictable reactions are possible with so many compounds potentially present. The heat generated from biological processes also tends to accelerate the release rate of compounds produced by chemical reactions.

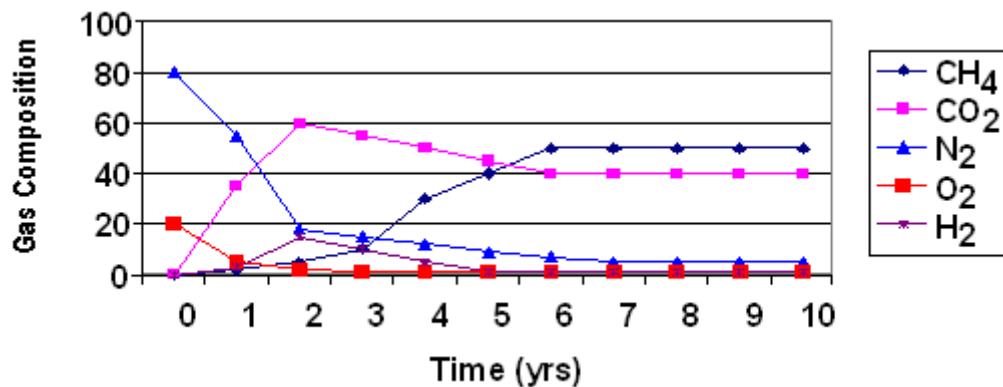

Figure 1.1. LFG Composition.

1.6. Factors Affecting LFG Generation. LFG generation in landfills is affected by several factors:

- a. Waste composition;
- b. Temperature;
- c. Moisture;
- d. pH;
- e. Atmospheric conditions;
- f. Landfill cover;
- g. Waste density; and
- h. Waste age.

1.6.1. Waste Composition. The primary nutrients (macronutrients) required for bacterial growth in a landfill are carbon, hydrogen, oxygen, nitrogen, and phosphorus. Small amounts of other elements (micronutrients), such as sodium, potassium, sulfur, calcium, and magnesium are also required for bacterial growth. The availability of macronutrients in the landfill mass has an affect on both the volume of leachate generated from microbial processes and the composition of the generated LFG. Landfills that accept municipal wastes generally have an adequate nutrient supply for most microbial processes to proceed. Specialized landfills such as those at military installations that handle hazardous materials or munitions wastes only, may not have sufficient nutrients in the waste to sustain a large microbial population. The primary sources of macronutrients are high organic wastes such as yard wastes, food wastes, and sewage sludge. Micronutrient requirements are very small and can usually be met by the trace amounts found in wastes and/or leached from cover soils.

1.6.2. Temperature. The optimum temperature range for aerobic decomposition is 54 to 71°C (130 to 160°F), while the optimum temperature range for anaerobic bacteria is 30 to 41°C (85 to 105°F). A dramatic drop in activity of anaerobic bacteria has been noted at temperatures below 10°C (50°F).

1.6.3. Moisture. Moisture is needed for biological decomposition of waste. The moisture content of municipal solid waste (MSW) as received typically ranges from 15% to 40% with an average of 25 percent. The moisture content can vary greatly in different zones of the landfill. Very low moisture content may prevent decomposition of waste and thus limit LFG production. The optimum moisture content to maximize LFG production is in the 50% to 60% range.

1.6.4. pH. The materials placed in a landfill can cause the pH of leachate within the landfill to vary widely. However, leachate is typically expected to be in the pH range of 5 to 9. The pH during methane formation is generally in the range of 6.5 to 8.0. One concern during the acidic stages of the biological process (or any other time leachate within the landfill exhibits a low pH) is that the reduced pH will mobilize metals that may leach out of the landfill, or become toxic to the bacteria generating LFG.

1.6.5. Atmospheric Conditions. Atmospheric conditions affect the temperature, pressure, and moisture content within a landfill. Landfill covers and liners help to isolate waste from atmospheric conditions by limiting oxygen intrusion, limiting infiltration of precipitation, and buffering the effects of temperature changes.

1.6.5.1. Ambient Temperature. Cold climates will reduce biological activity in the surface layers, reducing the volume of LFG generated. Deeper in the waste, the surface temperature affects are usually overcome by the heat generated by biological activity. The primary factors that affect temperature are waste depth, compacted density, microbial activity, chemical reactions, water content, and climate.

1.6.5.2. Pressure. Atmospheric pressure can have a minor affect on the rate at which LFG is released to the atmosphere. It can also influence the operation of LFG extraction systems. A decrease in barometric pressure results in a temporary increase in LFG flow and an increase in barometric pressure will cause LFG flow to temporarily decrease. This is because the pressure within the landfill changes at a slower rate than the atmosphere and a pressure gradient temporarily develops between the inside and outside of the landfill until these pressures equalize.

1.6.5.3. Precipitation. Precipitation dramatically affects the LFG generation process by supplying water to the process and by carrying dissolved oxygen into the waste with the water. High rates of precipitation may also flood sections of the landfill, which will obstruct LFG flow. The amount of precipitation that reaches the waste is highly dependent on the type of landfill cover system.

1.6.6. Density of the Waste. The density of waste fills is highly variable. An estimate of waste density is often required for estimating LFG generation rates. Several reported density values are shown in Table 1-2. The reported values shown are for MSW:

Table 1-2. Density of the Waste	
Waste Density kg/m ³ (lbs/cy)	Reference
474 to 711 (800 to 1200)	Stecker, Phillip, (1989). "Active Gas Recovery Systems," University of Wisconsin Sanitary Landfill Leachate and Gas Management Seminar, Madison, WI, December 4-7, 1989
650 (1100)	Emcon Associates (1980). "Methane Generation and Recovery from Landfills," Ann Arbor Science, Ann Arbor, Michigan
387 to 1662 (650 to 2800)	Landva, Arvid O., Clark, Jack I., (1990) "Geotechnics of Waste Fill," "Geotechnics of Waste Fill – Theory and Practice", ASTM STP 1070, ASTM, Philadelphia, PA

1.6.7. Age of Waste. Once anaerobic conditions are established, LFG generation should be significant for 10 to 20 years or longer. Landfills that are several decades old are less likely to produce large quantities of LFG, since most of the biological decomposition of the waste will have already taken place.

1.7. Transport Mechanisms. Transport of LFG occurs by the two principal mechanisms of diffusion and advection. Transport conditions both within the landfill and for the subsurface surrounding the landfill must be considered. These transport mechanisms are discussed in the following paragraphs.

1.7.1. Diffusion.

1.7.1.1. Molecular diffusion occurs in a system when a concentration difference exists between two different locations. Diffusive flow of LFG is in the direction in which its concentration decreases. The concentration of a volatile constituent in the LFG will almost always be higher than that of the surrounding atmosphere, so the constituent will tend to migrate to the atmosphere. Wind often serves to keep the surface concentration at or near zero, which renews the concentration gradient between the surface and the interior of the landfill, and thus promotes the migration of vapors to the surface. Geomembranes in landfill covers will significantly reduce diffusion because the geomembrane prevents LFG from diffusing to the atmosphere.

1.7.1.2. Specific compounds exhibit different diffusion coefficients. Diffusion coefficients are the rate constants for this mode of transport and quantify how fast a particular compound will diffuse. Published diffusion coefficients have been calculated using open paths between one vapor region (concentration) and another. This type of test is not very representative of the conditions found in a landfill. In landfills, LFG must travel a tortuous path around solids and liquids in its waste burial path; thus, the published diffusion coefficients must be used with care.

1.7.2. Advection. Advective flow occurs where a pressure gradient exists. The rate of LFG movement is generally orders of magnitude faster for advection than for

diffusion. LFG will flow from higher pressure to lower pressure regions. In a landfill, advective forces result from the production of vapors from biodegradation processes, chemical reactions, compaction, or an active LFG extraction system. Variations in water table elevations can create small pressure gradients that either push gases out (rising tide) or draw gases in (falling tide). Changes in barometric pressure at the surface can also have an impact on the advective flow of LFG.

1.8. Factors Affecting LFG Transport Mechanisms. LFG transport is affected by the following factors:

- a. Permeability;
- b. Geologic conditions;
- c. Depth to groundwater;
- d. Man-made features;
- e. Landfill cover and liner systems; and
- f. Barometric pressure.

1.8.1. Permeability. The permeability of waste has a large influence on LFG flow rates and LFG recovery rates. Coarse-grain wastes exhibit large values of permeability and more uniform LFG flow patterns. By contrast, fine-grained and heterogeneous wastes are characterized by small values of permeability and LFG flow patterns that are not uniform throughout the waste mass. Permeability of refuse is often reported in Darcys. One Darcy = $9.85 \times 10^{-9} \text{ cm}^2$. Reported values for the apparent permeability of MSW are in the range of 13 to 20 darcys. Water competes with air to occupy pore space within the solid matrix and ultimately reduces the effective porosity and ability of vapors to migrate through the landfill due to a reduction in available air pathways. This reduction will also reduce the rate of LFG flow and decrease recovery rates.

1.8.2. Geologic Conditions. Geologic conditions must be determined to estimate the potential for off-site migration of LFG. Permeable strata such as sands, gravels, and weathered bedrock provide a potential pathway for off-site migration, especially if these layers are overlain by a layer of low permeability soil. Geologic investigations must be performed to determine the potential for off-site migration. Additional attention must be given to areas where houses and other structures are present to ensure off-site migration will not impact these structures.

1.8.3. Depth to Ground Water. The water table surface acts as a no-flow boundary for LFG. As a result, it is generally used to help estimate the thickness of the zone through which LFG can travel. A consistently high ground water table will significantly reduce the potential for off-site migration of LFG. The depth to groundwater (as well as seasonal variations) also needs to be evaluated during the design process to evaluate well construction requirements and the potential for

water table upwelling (i.e., the upward rise of the water table toward a vacuum well screened in the unsaturated zone). EM 200-1-18 “Soil Vapor Extraction and Bioventing” provides a detailed discussion of upwelling.

1.8.4. Man-Made Features. In some instances, underground utilities such as storm and sanitary sewers or the backfill that surrounds these features may produce short-circuiting of airflow associated with an active LFG collection system. As a result, airflow may be concentrated along these features rather than within the landfill. Man-made features also provide a potential pathway for the off-site migration of LFG.

1.8.5. Landfill Cover and Liner Systems.

1.8.5.1. The components of many hazardous and solid waste landfill cover systems consist of a vegetated surface component, a drainage layer, and a low permeability layer composed of one or more of the following: geomembrane, geosynthetic clay liner (GCL), or compacted clay. A geomembrane in the cover system will prevent the intrusion of air into the waste. Therefore, a higher operating vacuum can be applied to the LFG collection system without the danger of overdrawing. Thus, the effective radius (reach) of influence of each well is increased. Overdrawing occurs when oxygen from the atmosphere is pulled into the landfills interior during the anaerobic phase.

1.8.5.2. Landfill liner systems consist of various combinations of low permeability layers and leachate collection layers. The low permeability layers are created using natural low permeability geologic formations, compacted clay, geomembranes, and geosynthetic clay liners (GCLs). Liner systems prevent the migration of LFG to the surrounding areas. Liner systems also prevent gases in the surrounding geologic formations from being pulled into the LFG collection system.

1.8.6. Barometric Pressure. The amount of LFG escaping from a landfill’s surface changes as barometric pressure changes. LFG generation within a landfill will result in a positive pressure gradient from the inside to the outside of the landfill. For a passive LFG collection system, increases in atmospheric pressure will cause a decrease in LFG flow from a landfill because the pressure differential between the inside and the outside has decreased. For an active LFG collection system, there is a higher probability of atmospheric air intrusion through the landfill cover during periods when the barometric pressure is rising. The amount of air intrusion will be greatly affected by the type of cover on the landfill. A landfill with a low permeability (geomembrane) cover will be more resistant to air intrusion than a landfill with a soil cover.

1.9. LFG Characteristics. LFG is typically a combination of methane, carbon dioxide, and non-methane organic compounds (NMOCs). The table 1-3 shows characteristics of some of the typical components of LFG:

1.9.1. Density and Viscosity. The density of LFG depends on the proportion of individual gas components present. For example, a mixture of 10% hydrogen and 90% carbon dioxide, such as might be produced in the first stage of anaerobic decomposition, will be heavier than air, while a mixture of 60% methane and 40% carbon dioxide, such as might be produced during the methanogenic phase of decomposition, will be slightly lighter than air. Some typical values for density and viscosity at 0° C (32° F) and atmospheric pressure are given in Table 1-4.

Table 1-3. LFG Characteristics			
Constituent	Relative Specific Gravity	Concentration in LFG	Notes
Air	1	NA	Forms explosive mixture with methane
Methane	0.554	40-70%	Explosive; LEL 5% in air; UEL 15% in air
Carbon Dioxide	1.529	30-60%	Forms weak acid; Asphyxiant
Hydrogen Sulfide	1.19	800 ppm	Forms strong acid Toxic: PEL = 10 STEL = 15
Water Vapor	0.62	100% Saturated	Forms acids with hydrogen sulfide and carbon dioxide
Benzene	2.8	30 ppm	Flammable Toxic: PEL 1.0 ppm STEL 5 ppm
Toluene	3.1	300 ppm	Toxic: PEL 100 ppm STEL 150 ppm
Organic Acids	GT 2	Traces	Odorous
Organosulphur Compounds	GT 1.5	50 ppm	Odorous
LEL = lower explosive limit; UEL = upper explosive limit; STEL = short-term-exposure limit; PEL = permissible exposure limit.			

1.9.2. Heat Value Content. During the methanogenic stage, LFG can be expected to have a heating value of 500 Btu/ft³ under good conditions. This value is about half that of natural LFG. The actual heating value of the LFG from a landfill is a function of the type age of the waste, the type of landfill cover, and many other factors that have been discussed previously in this section.

1.9.3. Non-Methane Organic Compounds. If a landfill contains a significant amount of MSW (i.e., general household and consumer refuse), the LFG produced will consist of approximately 50% methane, 50% carbon dioxide, and trace amounts of NMOCs. The concentration of NMOCs can range from 200 to 15,000 parts per million (ppm) according to research from the USEPA. NMOCs can originate as constituents of various types of consumer and small volume maintenance products disposed of in the MSW, or may be generated as biological and chemical degradation daughter products. Benzene, toluene, ethyl benzene and total xylenes (BTEX) can originate from the disposal of fuel and other petroleum-based and automotive products. NMOC concentrations could be higher if non-hazardous or hazardous industrial wastes were historically disposed of in the MSW landfill. In the

USEPA study, ethane, toluene, and methylene chloride were found at the highest concentrations in LFG, with average reported concentrations of 143, 52, and 20 ppm, respectively. The most frequently detected compounds reported were trichloroethene, benzene, and vinyl chloride. During the design phase of a landfill closure, historical records or word of mouth information should be obtained as to the type of wastes that were placed in the landfill and the potential for these wastes to create LFG emissions.

Table 1-4. Typical Values for Density and Viscosity at 0°C and Atmospheric Pressure		
Vapor Constituent	Density (kg/m³)	Viscosity (Pa*s)
Air	1.29	1.71×10^{-5}
Methane	0.72	1.03×10^{-5}
Carbon Dioxide	1.9	1.39×10^{-5}
50% CH ₄ + 50% CO ₂	1.35	1.21×10^{-5}
60% CH ₄ + 40% CO ₂	1.19	1.17×10^{-5}

1.9.4. Water Vapor. LFG created during the decomposition of organic compounds typically includes between 4 and 7 percent by volume water vapor. The actual water vapor content of LFG will depend on the temperature and pressure within the landfill. Temperatures are typically elevated over ambient during biological decomposition, increasing the evaporation of water into the LFG.

1.9.5. Others. Hydrogen is produced during waste decomposition, particularly during the initial anaerobic conversion of mixed organic acids to acetic acid. Significant amounts of hydrogen are later consumed in the formation of methane. Hydrogen is flammable between 4% and 74% by volume in air. The presence of carbon dioxide affects these ranges although little significant change occurs near the lower limit of the range.

1.10. LFG Condensate Characteristics.

1.10.1. Source of LFG Condensate. Condensate forms in the LFG collection and processing systems as the vapor phase undergoes changes in temperature and pressure. As LFG moves through the collection system, the vapor phase cools and the various constituents condense out. The condensed liquid is composed principally of water, organic compounds, and traces of inorganics such as particulate matter. The organic compounds are often not soluble in water and may separate from the aqueous phase. Most active LFG collection systems include a series of condensate collection pots that remove a portion of the entrained water from the LFG prior to entering the vacuum pump or blower.

1.10.2. Condensate Quality. The quality of LFG condensate is a function of:

EM 200-1-22

30 Apr 13

- a. Nature of the waste;
- b. Age of the waste;
- c. Moisture content;
- d. Temperature;
- e. Landfill size and configuration;
- f. Liner and/or cover materials; and
- g. Climatic conditions.

Volatile organic compounds (VOCs) frequently found in LFG condensate are listed in Table 1-5 below:

Table 1-5. Organic Contaminants		
Benzene	2-Butanone (MEK)	1,4-Dichlorobenzene
Toluene	Carbon tetrachloride	2,4-Dinitrotoluene
Phenol	Vinyl chloride	Hexachlorobenzene
Ethyl benzene	4-Methylphenol	Hexachlorobutadiene
Benzyl alcohol	Chlorobenzene	Hexachloroethane
Bis (2-Chloroisopropyl) ether	Chloroform	Nitrobenzene
Bis (2-ethylhexyl) phthalate	1,2-Dichloroethane	Pentachlorophenol
Napthalene	1,1-Dichloroethene	Pyridine
N-nitrosodimethylamine	Tetrachloethylene	2,4,5-Trichlorophenol
2,4-Dimethylphenol	Trichloethylene	2,4,6-Trichlorophenol

CHAPTER 2 Investigations

2.1. Site Characterization and Estimation of Landfill Gas Emissions. Site inspections, data review, and interviews should be performed to gather preliminary information about a landfill. Important preliminary information includes the following:

- a. Size and depth of the landfill;
- b. Nature of the waste and the potential for producing methane and other gases;
- c. Age of the waste;
- d. Type of cover and liner present;
- e. Existing landfill gas (LFG) collection and monitoring systems;
- f. Hydrogeologic conditions surrounding the landfill; and
- g. Location and number of adjacent buildings.

2.1.1. General. After preliminary information has been gathered, a decision needs to be made about how much additional information should be gathered in order to estimate the amount of LFG being generated and whether or not it is migrating off-site. The following paragraphs describe methods of site characterization, quantifying LFG production, and the potential for off-site migration. The work flow diagram presented below (excerpted from USEPA, 2005a) provides a visualization of the LFG evaluation process, with the remainder of this section focused on the LFG sampling and data analysis steps.

2.1.2. Landfill Characteristics. Physical investigations of the nature of the wastes within the landfill are rarely undertaken due to the heterogeneity of landfills and the difficulty of collecting representative samples from within a landfill. Preliminary information about the type and age of the wastes within the landfill should provide a good indication as to the amount and type of gases that will be generated. If additional information is required, soil gas surveys and pump tests can be used to better quantify the amount and types of LFG being produced. Soil gas surveys and pump tests are described later in this section.

2.1.3. Hydrogeologic Conditions.

2.1.3.1. The migration of LFG off-site is greatly affected by the geologic conditions at the site. High permeability materials such as sands, gravels, and fractured or weathered bedrock transmit vapors very effectively. Low permeability layers such as silts and clays have smaller pore sizes and do not transmit LFG as readily. These zones also retain higher moisture levels due to capillary forces and that pose an additional barrier to LFG flow. High permeability layers in contact with

landfills are capable of transmitting LFG over large distances, especially when these units are overlain by a continuous layer of low permeability material.

2.1.3.2. Hydrogeologic investigations must be performed to determine the geologic conditions, ground water table elevation, and potential paths for LFG to escape. EM 1110-1-1804, “Geotechnical Investigations”, EM 1110-1-1802, “Exploration for Engineering and Environmental Investigations,” and EM 200-1-17, “Monitor Well Design, Installation, and Documentation at HTRW Sites” provide general information on performing field investigations and well installation. Table 2-1 lists important parameters that should be determined when investigating the off-site migration of LFG.

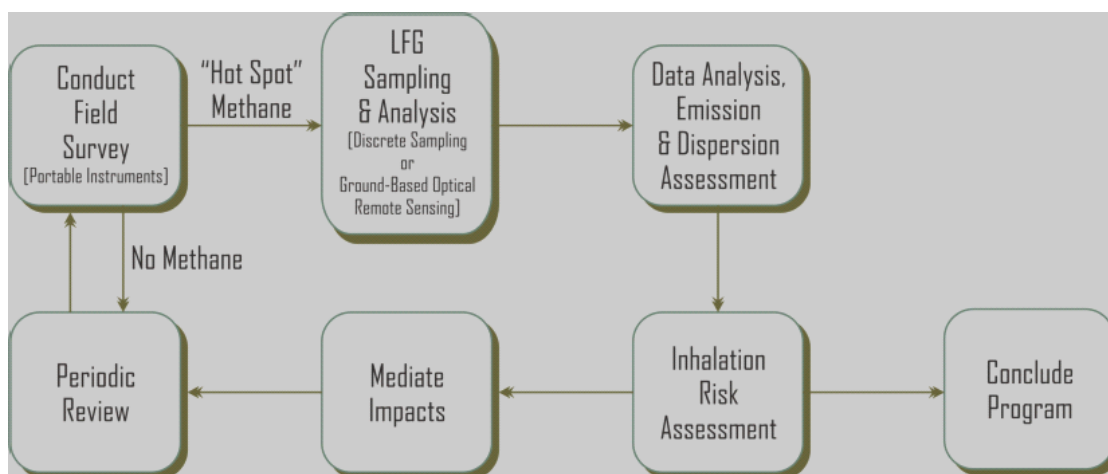

Figure 2.1. Data Gathering and Decision-Making Flow Chart for the Evaluation of LFG Emissions

Table 2-1. Important Parameters the Affect Off-Site Migration of LFG		
Parameter	Collection Method	Reference
Stratigraphy	Soil borings	EM 1110-1-1804 ASTM D 2487 ASTM D 2488
Depth to ground water	Monitoring wells	EM 200-1-17
Heterogeneity/utility trenches	Geophysical investigations	EM 1110-1-1804
Moisture content	Soil borings	ASTM D 2216
Grain size/porosity	Soil borings	ASTM D 422
Atterberg limits	Soil borings	ASTM D 4318
Vapor phase concentrations	LFG monitoring probes	EM 200-1-18

2.1.4. Ambient Air Quality. Ambient air quality monitoring may be necessary to determine the need for a LFG collection system. A typical monitoring program would include the collection of air samples at pre-determined locations based on

meteorological conditions at the site over an appropriate time period (8 hours, 24 hours, etc.). Current state-of-the-art techniques for evaluating ambient air concentrations and emissions from municipal solid waste (MSW) landfills include infrared radial surface mapping techniques using optical remote sensing. These techniques are very sophisticated and not likely applicable for most Army landfills, so they are not discussed in this EM. Refer to USEPA (2005a) and BCME (2010) for comprehensive discussions of these infrared mapping techniques, along with more sophisticated sampling strategies and statistical analysis. Ambient conditions, including temperature, barometric pressure, and precipitation events, should be recorded. Vapor phase parameters analyzed may include methane, hydrogen sulfide, and non-methane organic compounds (NMOCs).

2.1.5. LFG Monitoring Probes. LFG monitoring probes can be used during the investigation phase or for long-term monitoring to determine if LFG is migrating off-site through the subsurface. LFG probes should be installed in the more permeable strata between the landfill unit and either the property boundary or structures where LFG migration may pose a problem. Multiple or nested probes are useful in defining the vertical configuration of the migration pathway (refer to EM-200-1-18, "Soil Vapor Extraction and Bioventing" for use and construction of nested probes). Probe location and spacing is dependent of geologic conditions, water table conditions, and adjacent property use. LFG monitoring probe design and construction requirements are discussed in later sections of this EM.

2.1.6. Monitoring LFG in Structures. Basements and crawl spaces of buildings located near landfills are potential collection points for methane and other gases. Methane that collects in these confined spaces can create a potential explosion hazard. Basements and crawl spaces of buildings located in the vicinity of landfills should be monitored for LFG during the investigative phase, which is typically done using an explosimeter, flame ionization detector (FID), and/or various ambient air sampling techniques for laboratory analysis.

2.1.7. Soil Gas Surveys. Soil gas surveys can provide information about the production and migration of LFG, and are less costly and require considerably less field time than alternative sampling methods such as the installation of soil gas monitoring probes. Soil gas surveys can be either active or passive in nature. They can be used to collect information on methane and other volatile organic compound (VOC) emissions from a landfill. The data collected can be used for several purposes:

- a. Characterization of LFG composition as an indicator of the nature of the waste or to determine the health risk posed by the vapor phase constituents;
- b. Design of LFG collection and treatment systems;
- c. Identification of LFG migration; and/or

d. Assessment of the vapor intrusion pathway at landfills where LFG may be migrating into buildings.

2.1.7.1. Sampling Depths. Vapor phase concentrations diminish near the landfill surface due to diffusion into the atmosphere and advective exchange of air from the atmosphere. Generally, more concentrated vapors are found at depth, although concentrations vary significantly due to proximity to sources and preferred lateral migration pathways. Soil gas samples for characterization of LFG composition and design of collection and treatment systems should be taken at least three feet below the surface. In many cases, obstructions will prevent penetration of the sampling probe to the required depth and offset sampling locations will be required. Deeper sampling depths are appropriate where the waste layer is thick. When sampling for LFG migration, the depth of the sampling probe/well may be dictated by regulation, but should consider the depth of preferred migration pathways, based on the stratigraphy at the site, and the nature of potential exposure such as basements or manmade features.

2.1.7.2. Plan Location. The number and location of soil gas sampling points is dependent on the subsurface heterogeneity of both vapor flow paths and vapor sources. For characterization of LFG composition, the sampling locations should encompass the entire landfill. The density of sampling points should be increased in areas of the landfill where the waste thickness is greatest and in known source areas. For perimeter monitoring of LFG migration, the spacing of sample collection points may be dictated by regulation, but should consider the scale of heterogeneity in potential LFG migration pathways. Monitoring points are typically spaced every 100 to 500 feet around the perimeter of the landfill.

2.1.7.3. Sampling Methods. There are two primary means to collect subsurface vapor samples; active soil gas sampling and passive (non-pumping, sorbent) sampling. In addition, surface flux measurements can also be made. Samples can be collected on a grab real-time basis or using time-integrated sampling devices and protocol that incrementally collect a soil gas sample over an extended period of time (e.g., 24 hours). The following paragraphs describe each to these methods.

2.1.7.3.1. Active Soil Gas Sampling. Active soil gas sampling requires that samples of the actual soil gas filling the pore spaces in the subsurface be collected and analyzed. This method is most appropriate for gathering data on concentrations for LFG treatment system design, as well as the quantification and determination of risk posed by the LFG migration to receptors. These samples represent a snapshot of the LFG concentrations and are, therefore, susceptible to variations due to changes in barometric pressure, LFG generation rates, and precipitation events. Sampling requires placement (either temporary or permanent) of a probe or well into the subsurface. This can be accomplished by direct-push methods or a drill rig.

Drilling into a landfill requires additional safety precautions, and should be performed in accordance with EM 385-1-1, "Safety and Health Requirements," including preparation of a hazard task analysis. In some cases, slide hammers or similar devices can be used if the material into which the probe is to be placed poses little resistance.

2.1.7.3.1.1. Typically, decontaminated steel or PVC pipe/probes are used for temporary sampling probes, although drive tips connected to teflon tubing can be used, as can driven casing (e.g., using sonic or dual-tube casing hammer rigs - packers are placed in the casing to reduce the volume of air needed to be removed). Permanent probes are often installed in a manner similar to ground water monitoring wells and can be constructed of steel or PVC. Well seals that prevent intrusion of ambient air entry are critical. Refer to EM 200-1-18, "Soil Vapor Extraction and Bioventing" (Chapter 5) for more information on well/probe construction. Once installed, the probe or well is sampled by drawing a vacuum on the well using a vacuum pump and purging the well of several well volumes of soil gas. Typically, three to five times the well volume is purged. Monitoring of vapor concentrations as purging progresses can indicate the ideal amount of purging (e.g., stabilization of field screening measurements), but three well volumes is typically a minimum.

2.1.7.3.1.2. Actual sampling depends on the required container for the sample. Summa canisters can be used directly and are the proper choice for off-site analysis, but glass gas-tight syringes or Tedlar bags can be used for on-site field screening or analysis where short-term storage is involved. Care must be taken to avoid leakage of atmospheric air into the sample container during placement or removal of the sample container to/from the air stream. Refer to ASTM D5314 for more information on proper sampling methods. Upon completion of sampling, temporary probes are typically removed. The hole should then be sealed with grout or bentonite. Unnecessary permanent probes should be decommissioned in accordance with state regulation. Refer to EM 200-1-17, "Monitoring Well Design, Installation, and Documentation at HTRW Sites" for additional information on well decommissioning requirements.

2.1.7.3.2. Passive Soil Gas Sampling. Passive soil gas sampling techniques allow the sorption of the soil gas vapors onto activated carbon or similar material over some period of time. The sorbent material is later collected and submitted for thermal desorption and analysis. These methods do not allow the quantification of the soil gas concentrations unless flow is directed and measured through the sorptive cartridge or filter. This technique is most appropriate for qualitatively identifying the locations of contaminant sources or composition of the soil gas. These techniques allow a longer exposure to the soil gas, and are therefore less susceptible to variations due to barometric pressure changes, LFG generation rates, and precipitation events. Different vendors have different materials and placement methods. In some cases, the sorbent material is enclosed in an inverted glass vial or moisture resistant fabric and buried at depth in the soil for later retrieval. Other

vendors have materials that are set under a stainless steel cover at the ground surface. The materials are placed and left for some period of time (typically days to weeks) before retrieval. Proper retrieval requires the filling of any holes created as part of the survey.

2.1.7.3.3. Surface Flux Measurements. In some cases, there is a need to determine the amount and concentrations of LFG escaping to the surface. Flux chambers are used to quantify the mass of contaminants emanating from the subsurface. These chambers are boxes or domes open on the bottom and typically 0.5 - 1 m in lateral dimension. They are set at the ground surface with the open side set into the soil a small distance to provide an adequate seal. A carrier gas is introduced into the chamber on one side and collected into a Summa canister or similar container on the other side. The flux of the carrier gas is known and the chamber is left in place for a period of time. The concentration of the contaminants in the collected soil gas is determined and the mass of contaminants is calculated. The rate of mass emissions is then computed based on the time the chamber was in place.

2.1.8. Pump Tests. Pump tests can be performed to estimate LFG production. To perform a pump test, one or more extraction wells are installed and a blower is used to extract LFG. Based on LFG composition, landfill pressures, and flow measurements, the LFG production rate is calculated. LFG monitoring probes are used to estimate the radius of influence. Experience has shown the difficulty of accurately correlating pump test results with long-term LFG recovery, particularly at small landfills. Pump tests are, therefore, not normally recommended except for sites with the potential to produce large amounts of LFG over an extended period of time. Additional information on pump tests can be found in "Methane Generation and Recovery from Landfills" (Emcon and Associates, 1980). In addition, USEPA Method 2E, "Determination of Gas Production Flow Rate" can be used to calculate the flow rate of NMOCs from landfills. This method indicates that extraction wells should be installed either in a cluster of three or at five dispersed locations in the landfill. A blower is then used to extract LFG from the landfill. LFG composition, landfill pressures, and orifice plate pressure differentials (correlates to total LFG flow rate) from the wells are measured, which then allows the LFG production flow rate to be calculated from this data. USEPA Method 2E can be found in 40 CFR Part 60, Appendix A or at the following web site: <http://www.epa.gov/ttn/emc>.

2.1.9. Analytical Methods. The determination of the appropriate analytical methods is very project specific and depends on the project objectives, data quality objectives, and nature and concentration of contaminants of interest. The project chemist must be consulted to assure appropriate methods are chosen. Analysis can be conducted in the field using portable equipment or in a fixed lab.

2.1.9.1. Field Analyses.

2.1.9.1.1. Field screening analyses can be used to determine an initial estimate of conditions at the site. Field screening analyses are also used for periodic monitoring during the operation and maintenance phase of the project to determine what adjustments need to be made to the LFG collection and treatment system.

2.1.9.1.2. Infrared instruments are typically used to monitor gases (methane and carbon dioxide) below grade, while explosimeters are typically used to monitor potential explosive atmospheres above grade. A photoionization detector (PID) or colorimetric indicator tubes may also be used to monitor for certain NMOCs at above grade locations. The use of field portable GCs and GC/MSs is acceptable if there is a need to identify and accurately quantify specific NMOCs; however, these instruments must be operated by a trained analyst. For field GC or GC/MS work, and sometimes for other methods, some degree of quality control/quality assurance is often required, including analysis of duplicates, spikes, and blanks.

2.1.9.2. Fixed Laboratory Analyses. For definitive analyses, samples are sent to off-site labs and analyzed according to specified methods. Summa canisters are typically used to assure representative samples arrive at the lab. A chemist should be consulted for proper selection and coordination with an off-site lab. Additional information on test methods for air samples can be found in EPA/625/R-96/010b, "Compendium of Methods for the Determination of Toxic Organic Compounds in Ambient Air". This document describes Method TO-14A, which is a procedure for sampling and analysis of VOCs in ambient air. The method was originally based on collection of air samples in Summa canisters, but has now been generalized to other specially prepared canisters. USEPA Method TO-15 is similar to USEPA Method TO-14A, but involves an expanded list of VOCs that can be analyzed (e.g., ketones).

2.1.10. Data Analysis. The evaluation of the results is dependent on the sampling objectives. The characterization of potential sources typically involves the qualitative evaluation of the data looking primarily for the locations of the highest "hits". The analysis of the data for risk assessment purposes may involve statistical analysis, such as computation of the mean and upper confidence limit based on multiple data points. LFG migration pathways are determined based on the samples and the waste/stratigraphy in the area of vapor detections in the perimeter probes. For design of treatment systems, the raw concentrations of LFG constituents are typically averaged over the area of the collection system.

2.2. Estimation of LFG Production and Emissions. LFG production and emissions are site-specific and a function of both controllable and uncontrollable factors. It is, therefore, difficult to accurately predict the rate of LFG emissions from a landfill. A summary of reported methane generation rates is provided in Table 3-1. One approach to predicting LFG generation from a MSW landfill is to employ a simplified

model that is consistent with fundamental principles. Several models are available for estimating the LFG generation rate using site-specific input parameters. The LandGEM model was developed by the USEPA to estimate LFG emissions and to determine regulatory applicability to Clean Air Act (CAA) requirements. There are also other LFG emission models in use by industry. The CAA regulations allow states the opportunity to use the results from models other than LandGEM. However, most of these models are proprietary, and are thus not as readily available as LandGEM. Regardless of what model is used, the accuracy of the inputs drives the results, and given the level of uncertainty associated with these inputs, it makes estimating landfill emissions very difficult.

2.2.1. LandGEM. LandGEM provides an automated estimation tool for quantifying air emissions from MSW landfills. The LandGEM estimation tool is set up in Excel spreadsheet format, and can be downloaded along with its user's manual from the following web site: <http://www.epa.gov/ttn>. There are two sets of default input values available for use in the LandGEM estimation tool. One input data set is for use in determining regulatory applicability and emission requirements under the Clean Air Act (CAA), which represents very conservative input values. The other input data set is less conservative, and can be used to produce typical emission estimates in the absence of site-specific test data, and is mostly based on emission factors contained in the USEPA's "Compilation of Emission Factors" (otherwise known as AP-42). Site-specific data can also be inputted into LandGEM. Once total LFG emissions are estimated, LandGEM can then be used to estimate methane, carbon dioxide, total non-methane organic compounds (NMOCs), and individual toxic NMOCs based on default composition input or site-specific sampling data.

2.2.1.1. The LandGEM model is based on a first order decomposition rate equation. The estimation tool enables the user to estimate emissions over time using the following input parameters:

- a. Landfill design capacity;
- b. Amount of waste in place or the annual acceptance rate;
- c. Methane generation rate (k), and potential methane generation capacity (L_0);
- d. Concentration of total and speciated NMOCs;
- e. Years the landfill has been accepting waste; and
- f. Whether the landfill has been used for disposal of hazardous waste.

2.2.1.2. Defaults for k and L_0 are suggested for use as input parameters in LandGEM, although more accurate site-specific values can be developed using field test measurements in combination with methodologies specified in USEPA Method 2E. Default input values for both k and L_0 include both conservative values for regulatory compliance evaluation and recommended AP-42 default values. It is also

important to note that effective use of LandGEM and estimates of k and L_0 is also dependent on the knowledge and experience of the modeler. Also refer to USEPA (2005b) and the LandGEM User's Manual for further discussions and recommendations regarding input values. The estimation tool is designed to model and store multiple landfill studies. Within a landfill study, reports and graphs of the estimated emissions can be produced for any particular pollutant, including NMOCs (total and specific), methane, and carbon dioxide.

2.2.1.3. Information on the assumptions used in the LandGEM estimating tool can be found in the accompanying user's manual (USEPA, 2005b) that can also be obtained at the above LandGEM software website.

2.2.1.4. The LandGEM estimating tool has been used by landfill owners and operators to determine if a landfill is subject to the control requirements of the New Source Performance Standard (NSPS) for new MSW landfills (40 CFR 60 Subpart WWW) or the emission guidelines (EG) for existing MSW landfills (40 CFR 60 Subpart CC). The NSPS and EG were initially proposed May 30, 1991 (USEPA, 1991b), and the final rule was promulgated on March 12, 1996 (USEPA, 1996a). LandGEM has also been used to develop estimates for state emission inventories. Given the intended use of the estimating tool for either regulatory compliance or design purposes, there are two sets of default equations for LFG estimates.

2.2.1.5. The following equation should be used if the actual year-to-year solid waste acceptance rate is unknown:

$$M_{\text{NMOC}} = 2kL_0 \sum_{i=1}^n M_i (e^{-kt_i}) (C_{\text{NMOC}}) (3.6 \times 10^{-9})$$

where:

M_{NMOC}	=	total NMOC emission rate from the landfill, megagrams per year over years 1 to n.
k	=	methane generation rate constant, year ⁻¹
L_0	=	methane generation potential, cubic meters per megagram solid waste
M_i	=	mass of solid waste in the i th section, megagrams
t_i	=	age of the i th disposal cell, years
C_{NMOC}	=	concentration of NMOC, parts per million by volume as hexane
3.6×10^{-9}	=	conversion factor

The mass of non-degradable solid waste may be subtracted from the total mass of solid waste in a particular section of the landfill when calculating the value for M_i .

2.2.1.6. The following equation can be used if the actual year-to-year solid waste acceptance rate is known:

$$M_{\text{NMOC}} = 2L_0 R (e^{-kc} - e^{-kt}) (C_{\text{NMOC}})(3.6 \times 10^{-9})$$

where:

M_{NMOC}	=	mass emission rate of NMOC, megagrams per year
L_0	=	methane generation potential, cubic meters per megagram solid waste
R	=	average annual acceptance rate, megagrams per year
k	=	methane generation rate constant, year ⁻¹
t	=	age of landfill, years
C_{NMOC}	=	concentration of NMOC, parts per million by volume as hexane
c	=	time since closure, years. For active landfill $c = 0$ and $e^{-kc} = 1$
3.6×10^{-9}	=	conversion factor

The value of L_0 is most directly proportional to the waste's cellulose content. The theoretical methane generation rate increases as the cellulose content of the refuse increases. If the landfill conditions are not favorable to methanogenic biological activity (i.e., bacteria that degrade organic matter under highly anaerobic conditions that generates methane), there would be a reduction in the theoretical value of L_0 . This implies that the theoretical (potential) value of methane generation may never be obtained. The obtainable value of L_0 for the refuse (or specific waste components) can be estimated by performing biodegradability tests on the waste under conditions of temperature, moisture, nutrient content, and pH likely to exist in the landfill. Theoretical and obtainable L_0 values have been reported in literature to range from approximately 6 to 270 m³ of methane generation per metric ton of waste for MSW landfills.

2.2.2. Theoretical Models. The theoretical methane generation capacity (L_0) can be determined by a stoichiometric method that is based on a gross empirical formula representing the chemical composition of the waste. If a waste contains carbon, hydrogen, oxygen, nitrogen and sulfur (represented by $C_aH_bO_cN_dS_e$), its decomposition to LFG is shown as:

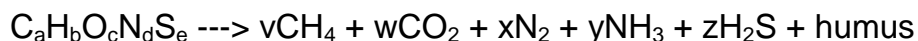

However, this type of model is of limited use because it provides an estimate of the total amount of LFG generated, and does not provide information on the rate of generation. It also requires knowledge of the chemical composition of the waste.

2.2.3. Regression Model. The USEPA Air and Energy Engineering Research Laboratory (AEERL) began a research program in 1990, with the goal of improving global landfill methane emission estimates. Part of this program was a field study to gather information that was used to develop an empirical model of methane

emissions. Twenty-one US landfills with LFG recovery systems were included in the study. Site-specific information included average methane recovery rate, landfill size, refuse mass, average age of the refuse, and climate. A correlation analysis showed that refuse mass was positively linearly correlated with landfill depth, volume, area, and well depth. Regression analysis of the methane recovery rate on depth, refuse mass, and volume was significant, but depth was the best predictive variable ($R^2 = 0.53$). Refuse mass was nearly as good ($R^2 = 0.5$). None of the climate variables (precipitation, average temperature, dew point) correlated well with the methane recovery rate. Much of the variability in methane recovery remains unexplained, and is likely due to between-site differences in landfill construction, operation, and refuse composition. A model for global landfill emissions estimation was proposed based on this data.

The following simple model correlating refuse mass to methane recovery with a zero intercept was developed: from these studies:

$$Q_{\text{CH}_4} = 4.52 W$$

where:

$$\begin{aligned} Q_{\text{CH}_4} &= \text{CH}_4 \text{ flow rate (m}^3\text{/min)} \\ W &= \text{mass of refuse (Mg)} \end{aligned}$$

More information on this model can be found in the following publication: EPA/600/SR-92/037, "Development of an Empirical Model of Methane Emissions from Landfills".

CHAPTER 3

Design of Landfill Gas Collection Systems

3.1. General. Landfill gas (LFG) control systems consist of collection, conveyance, and treatment components and are designed to be either passive or active. A passive system allows the LFG to exit the collection system without mechanical assistance, whereas an active system uses mechanical assistance, such as blowers, to extract the LFG. Depending on the potential health and environmental risks and local regulatory criteria, LFG can either be directly discharged to the atmosphere or collected for treatment. Design of collection systems and conveyance piping are described in this section. Other resources for LFG collection system and design include AP-42, USEPA (1999a), USEPA (2005a), and BCME (2010).

3.2. Methods of LFG Collection. LFG is generally collected using extraction wells, blankets, or trenches. The following sections describe each of these types of systems.

3.2.1. Wells. Well systems consist of a series of vertical LFG extraction wells (perforated or slotted collection pipes) that penetrate to near the bottom of the refuse or to near the depth of saturated waste. Well systems are often recommended for landfills or portions of landfills that exceed 12 m (40 ft) in depth. The design of a well system requires an estimate of the rate of LFG production and the radius of influence of the wells. A well system, either active or passive, is useful for layered landfills where vertical LFG migration is impeded. Because of the variability of landfill refuse, design procedures are difficult to apply to LFG collection systems. Vertical LFG collection wells are typically installed once filling operations have been completed, and are commonly spaced at a frequency of one per acre and are constructed using an auger type drill rig. As a general rule, where LFG collection efficiency is important, it is generally advisable to develop a tighter grid of extraction points with smaller spacings operated at a lower vacuum. It has been found that a vacuum of 10 to 25 inches of water column (in wc) represents a reasonable balance between maximizing zones of influence and minimizing air intrusion into the site. Operating at higher vacuum levels tends to extend the zone of capture beyond the limits of the waste burial and increase the potential for atmospheric air intrusion that could create a landfill fire/explosion hazard. The radius of the capture zone for a vertical extraction well may range from around 50 ft to 200 ft and is strongly dependent on localized landfill conditions. LFG recovery rates from an individual extraction well may range from approximately 10 to 50 cubic feet per minute (cfm).

3.2.1.1. Active LFG Vent Construction. The method of construction and components of active LFG extraction wells are similar to those of standard ground water monitoring or extraction wells (i.e., riser, screen, gravel pack).

3.2.1.1.1. Borehole. The borehole diameter for an active LFG collection well will typically range from 0.3 to 1 m (1 to 3 ft). The well boring will typically extend from the landfill surface to near the bottom of the waste. If the landfill contains a liner system beneath the waste, the well should be terminated a safe distance above the liner system to prevent damage.

3.2.1.1.2. Casing. A minimum 100 mm (4-inch) diameter HDPE or PVC casing is placed in the boring. The casing diameter should be based on pneumatic analysis of the system and anticipated LFG flow rates. In cases where landfill temperatures are high, other screen/casing materials such as steel and fiberglass should be considered. The operating service temperature range for HDPE pipe is reported to be -45.6 to 60°C (-50 to 140°F) for pressure service, and up to 82.2°C (180°F) for non-pressure service. The maximum operating service temperature for PVC is reported to be 60°C (140°F). The casing should be placed in the center of the borehole. A vertical extraction well can be equipped with a telescoping section if the differential settlement of waste over time is anticipated to be significant.

3.2.1.1.3. Centralizers. Centralizers center the casing in the borehole and must be a size appropriate for the casing and borehole. These are recommended for holes greater than 6 m (18 ft) deep. Select centralizers made of material that will not lead to galvanic corrosion of the casing. Stainless steel centralizers are recommended with PVC or stainless steel casing.

3.2.1.1.4. Screen. The bottom two-thirds of the well should be screened using either a perforated or slotted casing. However, if the cover system does not contain a geomembrane, the casing should extend a minimum of 3.048 to 4.572 meters (10 to 15 feet) into the waste. Perforated pipe with 15 mm (0.5 inch) diameter holes spaced at 90 degrees every 0.15 to 0.3 m (6 to 12 inches) may be used. Slotted or continuous wrap screen may also be used. Continuous-wrap screen is preferred because the increased open area reduces the pressure drop across the screen and, therefore, reduces energy costs for the blower. Slot size should generally be a minimum of 2.5 mm (0.10 in.) but should be as large as possible to reduce the vacuum drop across the screen. End caps consistent with the screen type should be specified for the bottom of the well screen.

3.2.1.1.5. Gravel Pack. A gravel pack should be placed around the screen. The gravel pack should extend a minimum of 0.3 m (12 in.) above the end of the screen. The gradation of the gravel pack will be dependent on the gradation of the waste surrounding the well and the diameter of the borehole. Typically, washed river gravel or crushed stone is used. AASHTO No. 57 stone has been specified on several USACE projects.

3.2.1.1.6. Seal and Grout. A 1.3 m (4 foot) layer of bentonite material is placed on top of the gravel pack. A 0.3 m (12 inch) layer of fine sand should be placed

between the gravel pack and grout if bentonite grout is used. The remainder of the borehole can be backfilled with cement-bentonite grout or a granular soil. Figure 3.1 is an example of an active LFG extraction well. A 0.3 m (12 inch) thick bentonite seal is sometimes placed on top of the granular soil layer just beneath the cover system.

3.2.1.1.7. Slip Couplings. Slip couplings are often used if settlement is likely to be severe. The slip coupling allows the well to telescope down as settlement occurs. Also, a prefabricated boot should be used to attach any geomembranes in the landfill cover to the LFG vent pipe. This will help minimize leakage of atmospheric air into the landfill.

3.2.1.2. Passive LFG Vent Well Construction. A passive LFG vent well should be similar in design to an active extraction well. The well should be constructed of PVC or HDPE and should be a minimum of 100 mm (4 inches) in diameter. The pipe should be placed in the center of a 300 - 600 mm (1 to 2 foot) diameter borehole and backfilled with gravel to a level of 3 foot (0.3 to 1 m) above the perforated or slotted section. The remainder of the hole should be backfilled in a fashion similar to an active LFG vent well. Figure 3.2 is an example of a passive LFG vent well.

THIS SPACE INTENTIONALLY LEFT BLANK

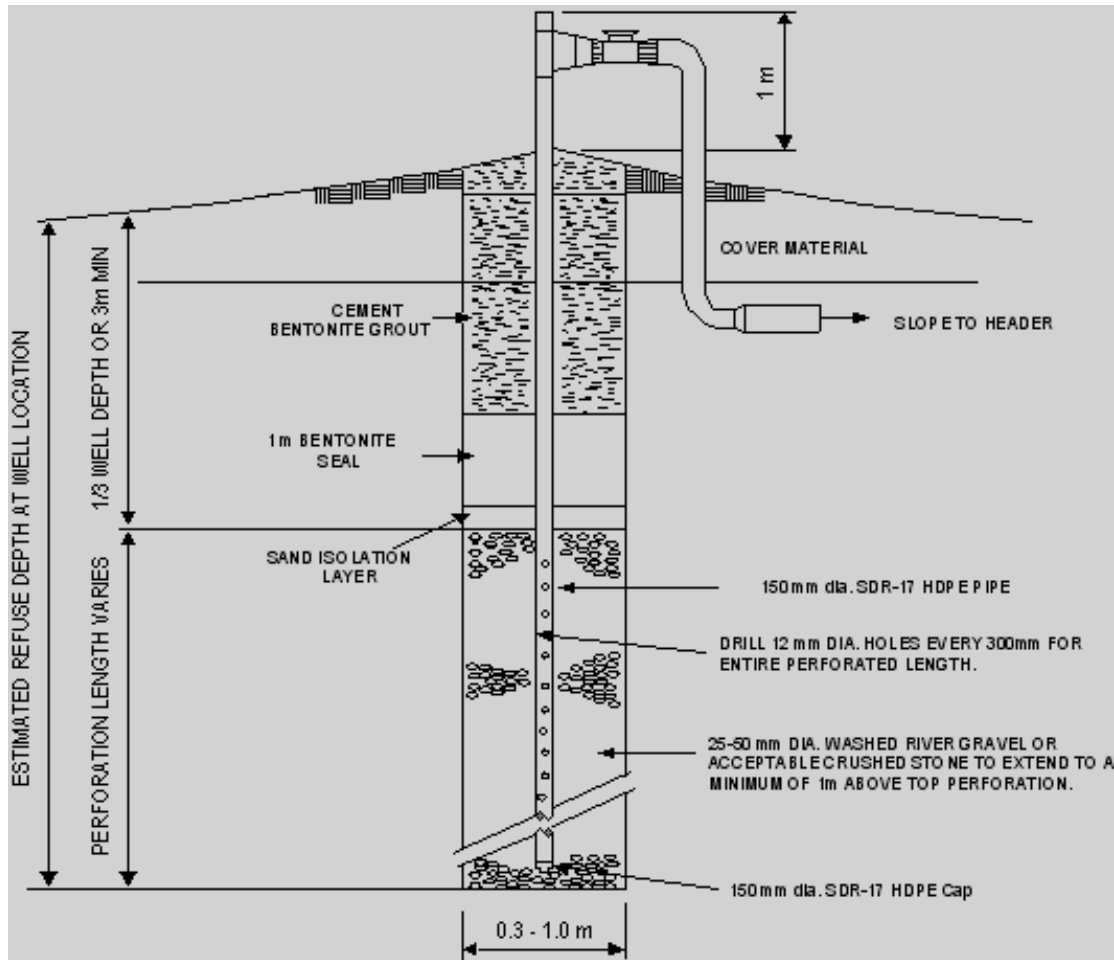

Figure 3.1. Typical LFG Extraction Well

3.2.2. Blanket Collection Systems. A continuous blanket collection system constructed of sand or gravel at a minimum of 0.3 m (12 inches) in thickness should be located below the impermeable barrier layer. A geosynthetic blanket with equivalent transmissivity properties can also be used. A continuous blanket system will allow free movement of LFG to either collection or outlet pipes. Vertical outlet pipes transport the collected LFG from beneath the landfill cover. The number of vent pipes should be minimized and are normally spaced about 60 m (200 ft) apart. This provides approximately one vent per acre. Perforated horizontal collection pipes can also be incorporated into the design of either passive or active blanket systems. A geotextile filter layer may be required to prevent clogging of the LFG collection blanket material. Continuous blanket systems are effective in preventing excessive pressure from building up beneath the low permeability layer. They are less effective in preventing off-site migration of LFG, since there are no wells extending into the refuse. LFG wells or perimeter trenches should generally be used if off-site migration of LFG is a concern.

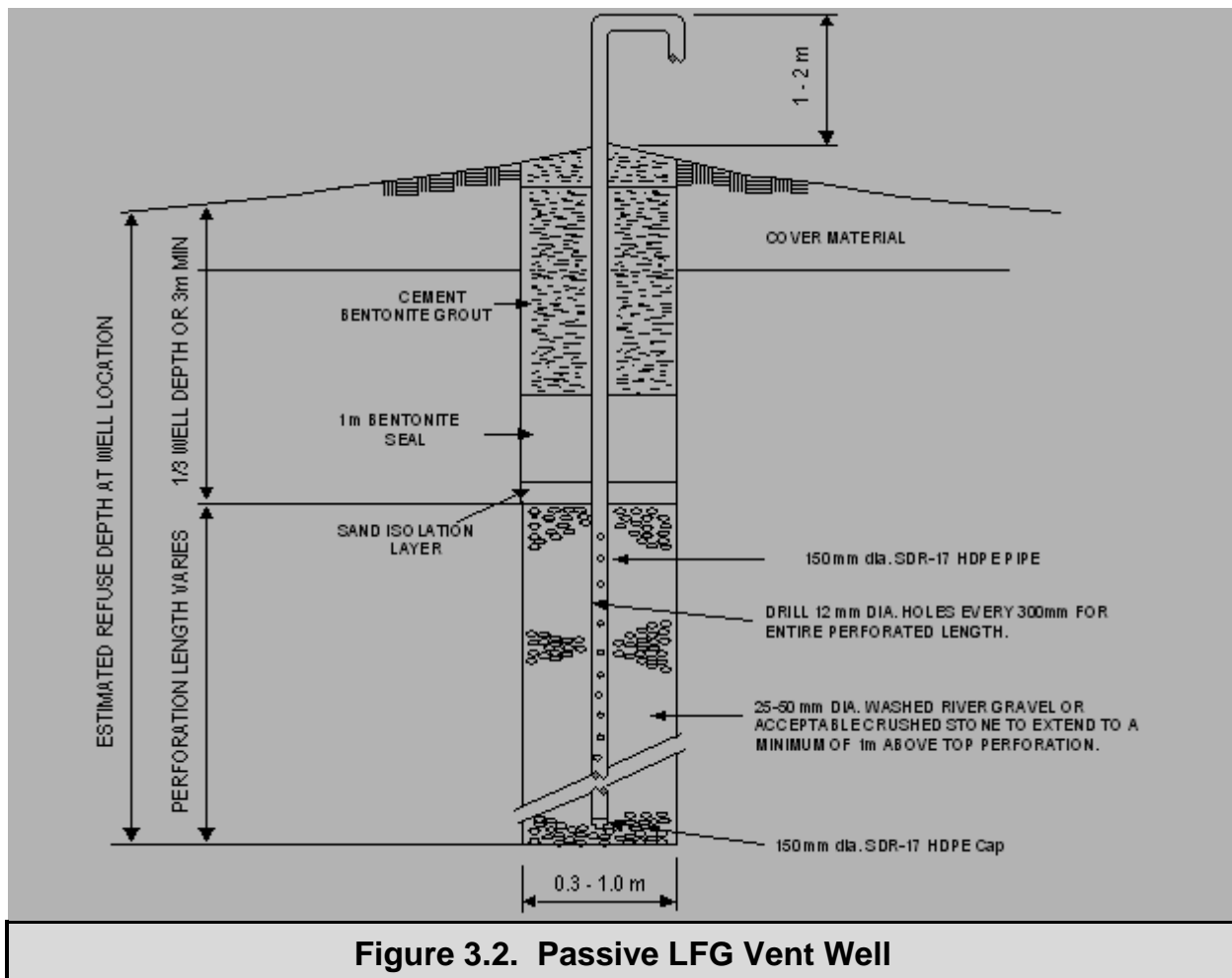
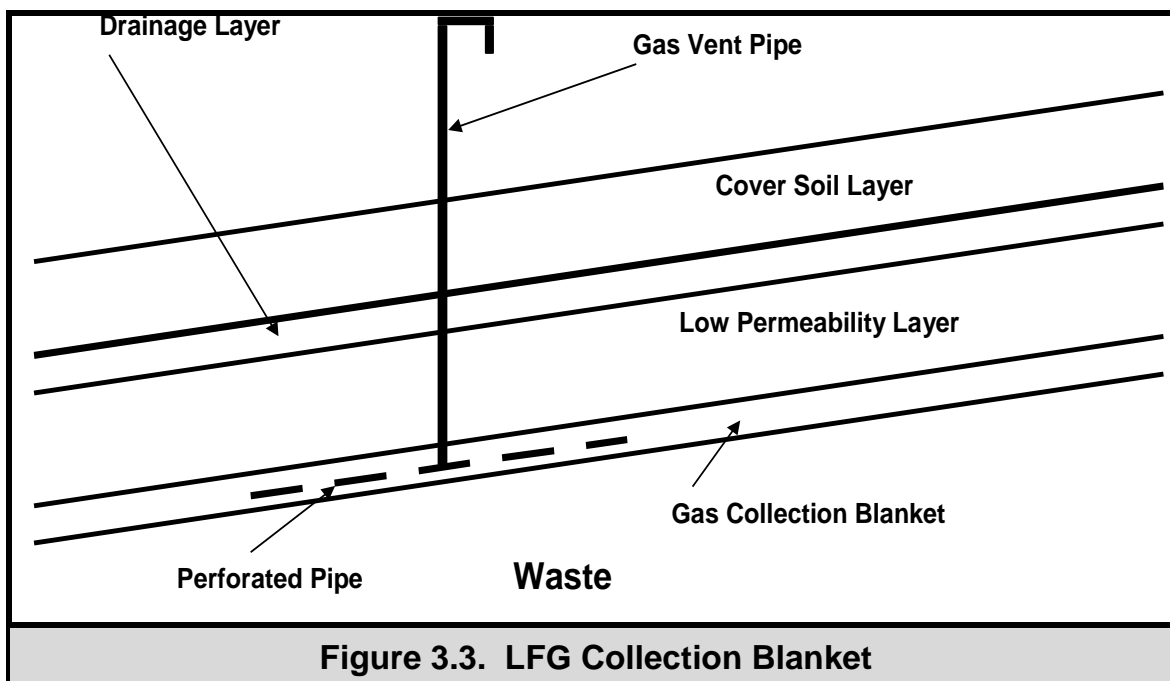

Figure 3.2. Passive LFG Vent Well

3.2.2.1. Granular Blankets.

3.2.2.1.1. The design of a granular collection blanket system requires choosing an appropriate material for use in the LFG collection layer and determining the layer thickness. Typically, the minimum thickness is 0.3 m (12 inches). Granular material should have minimum fines to facilitate the flow of collected LFG. AASHTO No. 57 stone is frequently specified for granular LFG collection layers due to the general availability of this material. Geotextiles are often used to separate the granular blanket from other soils and refuse.

3.2.2.1.2. If large diameter (> 12.5 mm [0.5 in.]) or angular materials are used for the LFG collection layer, overlying geomembranes should be protected with a geotextile or soil cushion layer. Geotextile cushion layers typically have a minimum weight of 0.4 kg/sq m (12 ounces/sq yard). Details regarding cushion layer design are given in "Design Methodology for the Puncture Protection of Geomembranes" (Wilson-Fahmy et al. 1996). Figure 3.3 shows a typical cross-section of a granular blanket LFG vent layer.



3.2.2.2. Geosynthetic Blankets.

3.2.2.2.1. Geosynthetic LFG collection systems have often been used to replace granular materials, because they require less space and are easier to construct. A geosynthetic LFG collection system typically consists of a three-dimensional geonet drainage core with a geotextile fabric attached to one or both sides. The geotextiles act as a filter/separator from adjacent layers of waste and soil. Geonets typically range from 5.0 to 8.0 mm (0.20 to 0.30 in.) in thickness but can be considerably thicker.

3.2.2.2.2. Thick, nonwoven needle-punched (NWNP) geotextiles have also been used as LFG collection blankets. However, they are effective only for very low volumes of LFG and for low normal stresses. For these reasons, geonets/geocomposites are almost always preferred over geotextiles alone.

3.2.3. Trenches.

3.2.3.1. Perimeter Trenches. A trench can be constructed around the perimeter of a landfill to prevent the off-site migration of LFG. The trench should extend from the ground surface to an impermeable geologic strata or the ground water table. The feasibility of installing a LFG collection trench is dependent on the depth to the impermeable strata, the ease of excavation of the material into which the trench is being placed, and fluctuations in the ground water table. Collection trenches are typically 0.9 m or more (3ft or more) wide and are filled with gravel such as

AASHTO No. 57 stone. Effectiveness can be improved by installing a 1.0 to 1.5 mm (40 to 60 mil) geomembrane on the outside wall of the trench. A protective geotextile should be placed between the collection rock and the geomembrane to prevent damage to the geomembrane. Seaming of geomembrane sheets within the trench is difficult and must be done using trench boxes to protect workers. A low permeability cover should be placed over the top of the collection trench to prevent precipitation from getting into the trench and saturating the collection rock. Figure 3.4 depicts an example of a perimeter LFG collection trench.

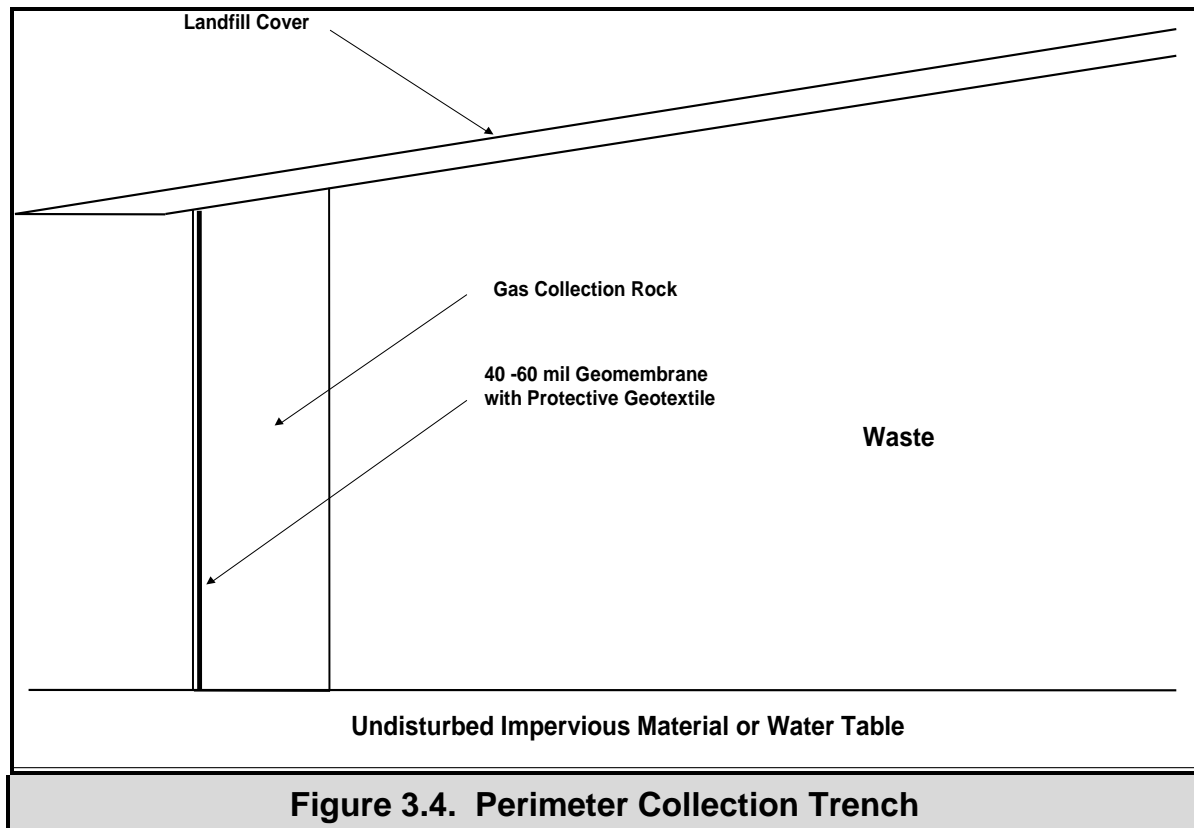

3.2.3.2. Surface Collection Trenches. For landfills where the waste materials are relatively shallow (less than 12 m [40 ft] in depth), surface collection trenches are sometimes used to collect LFG. One advantage of using horizontal collection trenches versus vertical extraction wells is the ability to collect LFG beneath active areas of a landfill while it is still being filled. The trenches are typically excavated 0.5 to 1 m (1.5 to 3 ft) into the waste. The trenches are then lined with a geotextile and filled with rock. A perforated pipe is often placed within the rock to increase flow capacity. The trenches should be spaced approximately 60 m (200 ft) apart and are usually not interconnected. Vertical vent pipes are located at the ends of the trench, or at high points, and spaced 60 m (200 feet) apart for passive vent trenches. LFG

is removed from active vent trenches using a series of header pipes. This will allow for individual lines to be valved independently for future system control and balancing.

3.2.3.3. Horizontal Trench Collection Systems. An example of a horizontal trench collection system is shown in Figure 3.5. This type of collection system can be installed during the placement of waste in an active landfill and is, therefore, not applicable to the closure of old landfills.

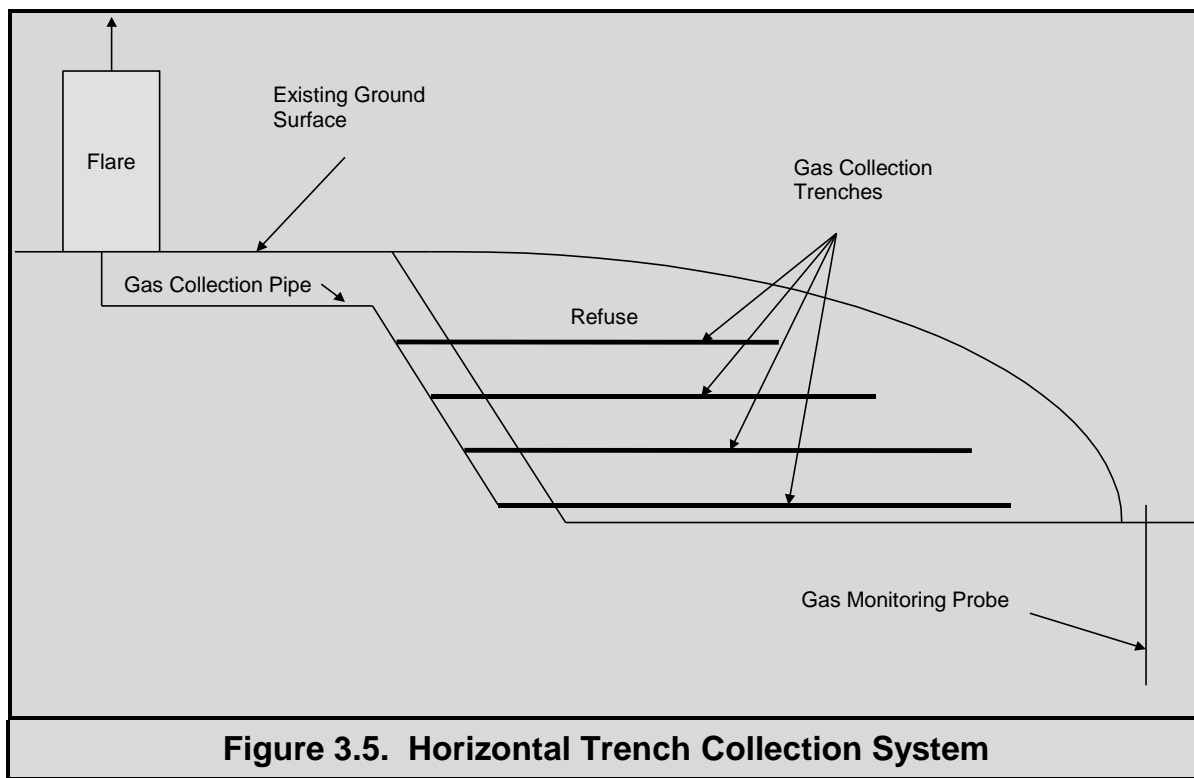

3.3. LFG Monitoring Probes.

3.3.1. General. Monitoring probes are used in conjunction with both active and passive systems to detect LFG that is migrating off-site. The regulatory compliance point is typically the property boundary. The maximum acceptable concentration of methane in the probes is typically 0.5% to 5% by volume. Federal regulations require that LFG concentrations not exceed the lower explosive limit (LEL) for methane (i.e., 5% methane by volume) at the property boundary or 25% of the LEL for methane (i.e., 1.25% methane by volume) in facility structures. Increased monitoring and/or modifications to the operating procedures of the LFG collection system are required if methane concentrations exceed acceptable levels. LFG samples may be also be analyzed for volatile organic compounds (VOCs) to determine if there is a need to perform a soil gas survey to evaluate the vapor intrusion exposure pathway.

3.3.2. Design Considerations. LFG monitoring probes are installed by placing a borehole into the ground to at least the same depth as the deposited waste. A 1.9 to 5.1 cm (0.75 to 2 inch) diameter perforated PVC pipe is placed into the hole and the space between the borehole wall and pipe is filled with sand or gravel. The sand and gravel layer should generally begin at least 1.5 m (5 feet) below ground surface (bgs) to reduce the potential for leakage of atmospheric air into the probe. A bentonite seal is placed above the filter pack and cement-bentonite grout is typically placed above the bentonite seal. Additional information on the design of LFG monitoring probes can be found in EM 200-1-18, "Soil Vapor Extraction and Bioventing".

3.3.2.1. It may be best to initially install probes deep enough to verify the water table and to assess stratification. Subsequent probes should then be placed above the water table in relatively permeable strata that is likely to be a good conduit for the movement of methane. It is advisable to install LFG monitoring probes at various depths where the unsaturated layer adjacent to deep landfills is thick.

3.3.2.2. Probes are typically placed around the perimeter of the landfill at a maximum spacing of 150–300 m (500–1000 ft), although they may be closer, depending on site specific factors such as adjacent land use, soil properties, and migration potential. At some sites, probes may be closely spaced, every 30–60 m (100–200 ft), if there are buildings near the landfill. Each probe must be permanently marked or tagged with an identification number to ensure data is accurately recorded.

3.3.2.3. Probes may be driven into the ground if they are going to be used to monitor strata that are less than 5 to 15 ft bgs.

3.3.3. Monitoring Devices for Structures. Basements and crawl spaces of buildings located near landfills are potential collection points for methane. Methane that collects in these confined spaces can create a potential explosion hazard. An explosimeter should be used to periodically monitor these confined spaces for explosive conditions. Federal and state regulations typically require that explosive concentrations of methane in structures on and off the landfill must not exceed 25% of the LEL (1.25% methane by volume). Corrective actions are often initiated if the monitor detects methane at concentrations as low as 10% of the LEL. In addition to monitoring for explosive gases, oxygen monitoring should be performed during entry into confined spaces. If the confined space is permit required, follow the procedures in 29 CFR 1910.146, Permit-required confined spaces.

Note that structures that actually are part of the LFG control system (e.g., piping, vaults) are excluded from this requirement.

3.4. Cover Penetrations.

3.4.1. General. Penetrations through the landfill cover are required for LFG vents, monitoring probes, and for other purposes. Geomembranes should be attached to the penetrating pipe in a way that ensures a watertight seal but still allows for movement from settlement or horizontal displacement. Geomembranes are generally attached to penetrations using a boot that attaches to the pipe.

3.4.2. Design Considerations. Most geomembrane manufacturers have their own typical penetration details. Therefore, in many cases, it is only necessary to show locations of the penetrations on the drawings and note that penetration details must be in accordance with approved geomembrane manufacturer's details. ASTM D 6497 – "Mechanical Attachment of Geomembrane to Penetrations or Structures" can also be referenced when specifying penetration requirements for geomembranes. Geosynthetic clay liner (GCL) penetration details should also be as recommended by the GCL manufacturer. Pipes that penetrate deeply into the waste material are likely to settle at a different rate and to a smaller magnitude than the adjoining landfill cover. The differential settlement between the pipe and the cover system creates stress concentrations at the boot connection that can tear the geomembrane away from the pipe. Slip couplings are typically used in this situation to allow differential movement while maintaining a watertight seal.

3.5. Header Piping.

3.5.1. General. Header piping is used for active systems to transport LFG from the collection wells to the flare. Additional information regarding piping design and various ancillary equipment discussed in this section, as well as piping design data and equations, can be found in EM 1110-1-4008, "Liquid Process Piping". Piping runs should be pressure tested immediately upon installation prior to backfilling. Leaking piping can increase oxygen content and reduce methane content of the LFG, which would reduce the quality of the LFG and possibly pose a risk of landfill fire or explosion.

3.5.1.1. The piping system will typically have several branches. Multiple extraction wells are attached to each branch and valves are used to control the amount of flow coming from individual wells and branches. The number of low points in the header should be minimized, and the flare should be located at a relative low point to aid in condensate collection within the header pipe system. The piping can be placed on the landfill surface or it can be buried. In most instances, the header pipe should be buried to minimize the risk of damage from maintenance equipment and vandalism. Burying the header pipe also reduces the potential for blockage due to condensate freezing in the pipes. Buried header pipes are typically located above the geomembrane in the cover system. There should typically be a minimum of 150

mm (6 inches) of bedding material between the geomembrane and the header pipe. A magnetic locator tape can be installed approximately 150 mm (6 inches) above the pipe, which can serve either as a warning to maintenance workers who may be excavating into the landfill cover, or as an aid in locating buried pipe for maintenance purposes. Heat tracing can also be used to ensure condensate does not freeze in locations where the pipe cannot be installed below frost depth. Buried piping depths and bedding design should be capable of withstanding dead and live loads that may be applied, particularly from heavy equipment traffic.

3.5.1.2. Above-ground header pipes should only be considered where differential settlement of the landfill surface could result in reverse grades along the header pipe. Above-ground pipe will need to be supported and sloped so that there is positive drainage to condensate collection pots. Placement of header pipe on the landfill surface is problematic in cold climates due to freezing condensate that can block the piping. Above-ground headers also make mowing and other maintenance activities more difficult.

3.5.2. Design Considerations.

3.5.2.1. Pipe Material Options. Header pipes are typically made of HDPE or PVC. PVC pipe is more susceptible to damage due to differential settlement than HDPE pipe because PVC is more rigid and brittle. Because of its relative flexibility, it is often easier to install HDPE piping in uneven terrain or long runs that dictates the need to frequently bend or alter its direction. PVC is also more vulnerable to ultraviolet (UV) radiation and low temperatures (4°C or 40°F) than HDPE pipe. PVC pipe must be painted with UV inhibitive paint if it is to be exposed to direct sunlight. PVC header pipe is easier to install than HDPE pipe because it can be solvent welded. HDPE pipe must be heat fusion welded by trained installers, which is more time consuming and costly.

3.5.2.2. Pipe Slopes. For both below and above-ground piping installations, condensate collection points should be located at low points in the header pipe system to prevent blocking of the pipe with condensate. Depending on local regulations, condensate is sometimes allowed to drip back into the waste either through the wellheads or separate percolation drains where possible. In addition to the pipe sloping recommendations described below, any piping placed on waste should be graded to provide a minimum 5% slope to minimize the potential for ponding due to localized differential settlement. Header pipes should be sloped according to the following criteria:

	Condensate flow in direction of LFG flow	Condensate flow opposite direction of LFG flow
On Landfill	2% slope	4% slope
Off Landfill	1% slope	3% slope

3.5.2.3. Pipe Size. The header piping should be sized to provide for minimal head losses and additional capacity should supplementary extraction wells be required at a later date. Pipes should be sized for approximately 25 mm (1 inch) of water column pressure drop per 30 m (100 ft) of pipe. This will give a good balance between blower and piping cost. Overall pressure drop along the header system piping runs due to frictional and other minor losses should generally be in the range of less than 10 in wc. Condensate will flow along the bottom of the header piping and is another consideration when sizing LFG header pipes. LFG velocity should be limited to 12 meters per second (40 feet per second) when the LFG and condensate are flowing concurrently, so that the vapor will condense on the header piping side walls. LFG velocity should be limited to 6 meters per second (20 feet per second) when condensate flow direction is opposite that of the LFG to avoid the condensate blocking the flow of LFG.

3.5.2.4. Flexible Connections. Flexible hoses are commonly used at well-heads, header and lateral pipes, pump stations, knock-outs, main lines, and at other connection points where there is expansion, contraction, and pipe movement due to landfill settlement. Flexible connections prevent excessive stress, which is one of the most common causes of LFG conveyance line failure. Flexible hoses should be designed to withstand system pressures and deterioration due to condensate and ultraviolet (UV) radiation. Flexible hose is typically constructed from a helix of stainless steel wire encapsulated within inner and outer layers of polyester fabric and impregnated with silicone rubber that is UV-resistant. The hose is typically held in place with stainless steel bands. Flexible hose can also be welded or glued to some types of plastic pipe (PVC, CPVC, and ABS plastic pipe). The hose should be installed to prevent low spots where condensate can accumulate and block the flow of LFG.

3.6. Valves.

3.6.1. General. Valves are utilized in LFG collection systems for flow rate control and on/off control. A typical system will have a flow control valve on each extraction head. The valves may be manually controlled or automatically actuated by an electric or pneumatic power source. Pneumatic actuators tend to be simpler and less costly than electric actuators, particularly for explosion-proof applications. For the closure of old landfills, LFG collection systems often do not rely on automated control valves. The selection and layout of valves in the LFG system should be carefully evaluated during the design process to ensure that the level of control provided in the system is consistent with projected operation and maintenance (O&M) needs. The following considerations should be given when selecting valves.

3.6.1.1. Temperature Range. Valves must operate safely in the temperature and pressure range of the system. PVC valves are prone to failure at low tempera-

tures; therefore, lined metal or HDPE valves are preferable for cold-weather service. In some situations, valves must be insulated and/or heated to prevent condensation.

3.6.1.2. Flow Capacity and Pressure Range. The operating range of a control valve must match the flow control requirements of the application. A flow control valve functions by creating a pressure drop from the valve inlet to outlet. If the valve is too large, the valve will operate mostly in the almost closed position, giving poor sensitivity and control action. If the valve is sized too small, the upper range of the valve will limit flow.

3.6.1.3. Strength and Durability. Because LFG systems consist of multi-phase flow, valves and fittings should be constructed of stronger and more durable materials than might normally be required in single-phase water or gas service. The condensate can often form slugs of water drawn through the system at relatively high speed. This can result in a "water hammer" or impact loading on the valves and fittings.

3.6.1.4. Frictional Losses. Valves must not create excessive frictional loss when fully opened.

3.6.1.5. Chemical Compatibility. Valves must be chemically compatible with the liquid or air stream.

3.6.2. Design Considerations. Formulas and sizing procedures vary with valve manufacturer. Computations typically involve calculating a capacity factor (C_v), which depends on the flow rate, specific gravity of the fluid, and pressure drop. The designer calculates C_v at the maximum and minimum flow rates required. The calculated range of C_v values must fall within the range for the valve selected. During the mechanical layout of the system, assure that the valves are accessible. Number and tag the valves. To avoid ambiguity, refer to the valves by number in the design and in the O&M manual. The following is a brief description of several valves commonly employed for LFG collection and treatment systems:

3.6.2.1. Gate Valve. Gate valves are primarily designed to serve as isolation valves. In service, these valves generally are either fully open or fully closed. When fully open, LFG flow through the valve is in a straight line with very little resistance. As a result, the pressure loss through the valve is small. Gate valves are frequently used at wellheads to isolate or stop flow from individual wells.

3.6.2.2. Butterfly Valve. Butterfly valves are used for both on/off and throttling applications at wellheads and for other applications. The butterfly valve is characterized by fast operation and low pressure drop. Flow is controlled with a rotating disk or vane. This valve has relatively low friction loss in the fully open position. Butterfly

valves can more accurately control a flow rate in LFG or multi-phase service than gate valves.

3.6.2.3. Globe Valve. Used for on/off service and clean throttling applications, this valve controls flow with a convex plug lowered onto a horizontal seat. Raising the plug off the seat allows for fluids to flow through. Globe valves can more accurately "pinch" or control a flow rate in LFG or multi-phase service than butterfly valves.

3.6.2.4. Ball Valve. Also used primarily for on/off control and some throttling applications, the ball valve uses a rotating ball with a hole through the center to control flow. Ball valves can be operated quickly and result in negligible resistance to flow when fully open.

3.6.2.5. Diaphragm Valve. A multi-turn valve used to control flow in both clean and dirty services. The diaphragm valve controls flow with a flexible diaphragm attached to a compressor and valve stem.

3.6.2.6. Needle Valve. A multi-turn valve used for precise flow control applications in clean services, typically on small diameter piping. Needle valves have relatively high frictional losses in the fully open position.

3.6.2.7. Check Valve. Check valves are used to allow flow in one direction only. Check valves are sometimes needed between the well and the pump to prevent air from being drawn backward when the pump is shut off. Under high vacuum, this can affect a variety of in-line readings, particularly if a carbon canister is being used for air treatment.

3.6.2.8. Sample Valve. Quick connect sample valves are used on LFG monitoring probes and wellheads to check pressure or LFG constituent concentrations.

3.7. Wellheads. Wellheads for passive LFG vents are typically configured to prevent precipitation and wildlife from entering the well. Wellheads for active well systems typically include control valves to increase and decrease the flow of LFG from individual wells and flexible connections to compensate for differential movement between LFG wells and header pipes. The wellhead will also include sampling ports to monitor LFG concentrations, temperature, velocity, and pressure. Specialty companies have created data collection ports that can be easily attached at each wellhead to allow easy collection of this data. Portable measuring equipment can be attached to the measuring ports to collect the required data.

3.7.1. Flow Rate Measurement. Pitot tubes and orifice plates are the two most common methods of measuring flow at a wellhead of a LFG collection system.

3.7.2. Orifice Plate. An orifice plate is a thin plate with a circular hole in the center (See Figure 3.6). The plate is placed within a pipe perpendicular to the direction of LFG flow. Orifice plates are used to determine LFG flow rate by measuring the differential pressure across the orifice plate. They are generally less expensive to install and manufacture than the other commonly used differential pressure flow meters; however, nozzle and venturi flow meters have the advantage of lower pressure drops. Equations for orifice plates have the advantage of no Reynolds Number upper limit for validity. An orifice plate flow meter is typically installed between flanges connecting two pipe sections. LFG flow calculations include an expansion factor. The expansion factor accounts for the effect of pressure change on vapor density as LFG flows through the orifice.

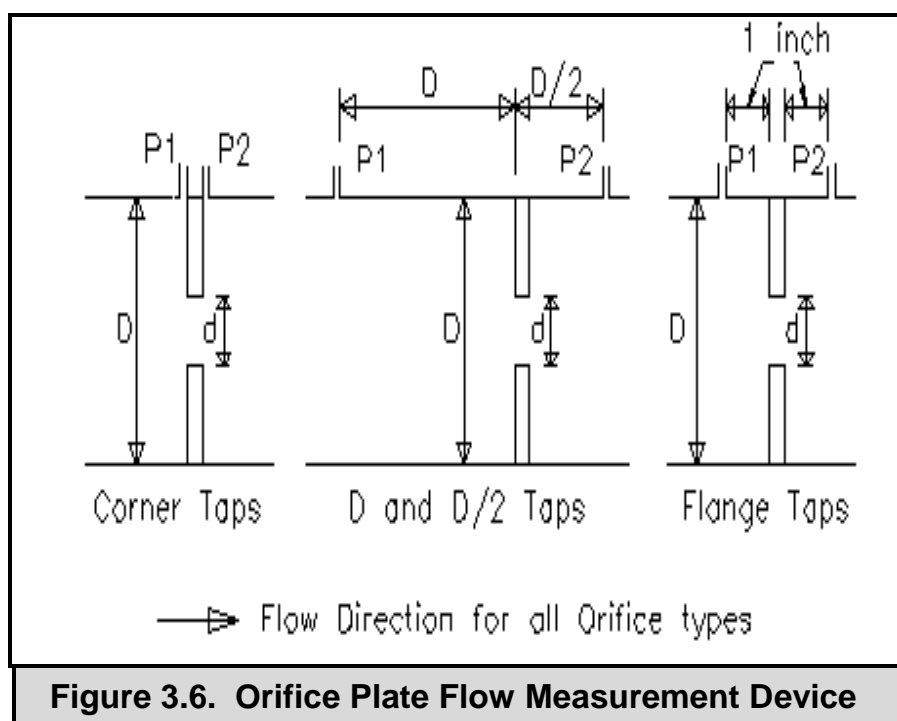

Figure 3.6. Orifice Plate Flow Measurement Device

3.7.3. Pitot Tube. A pitot tube is used to measure velocity based on a differential pressure measurement as shown in Figure 3.7. The Bernoulli equation models the physical situation very well. A pitot tube can also give an estimate of the flow rate through a pipe or duct if the pitot tube is located where the average velocity occurs. The average velocity times the pipe cross sectional area equals the flow rate. Often, pitot tubes are incorrectly installed in the center of a pipe. This gives the velocity at the center of the pipe, which is usually the maximum velocity in the pipe, and could be twice the average velocity. Though slightly more expensive, the use of averaging pitot tubes are recommended over point velocity pitot tubes to better account for the distribution of velocities over a pipe diameter. See ACGIH® “Industrial Ventilation: A Manual of Recommended Practice” for additional information on the use of pitot tubes.

Bernoulli's equation is used to estimate flow velocity based on pressure measurements from a pitot tube:

$$V = [2 (P_T - P_S)/\rho]^{0.5}$$

where:

V = fluid velocity
 P_T = total pressure
 P_S = static pressure
 ρ = fluid density.

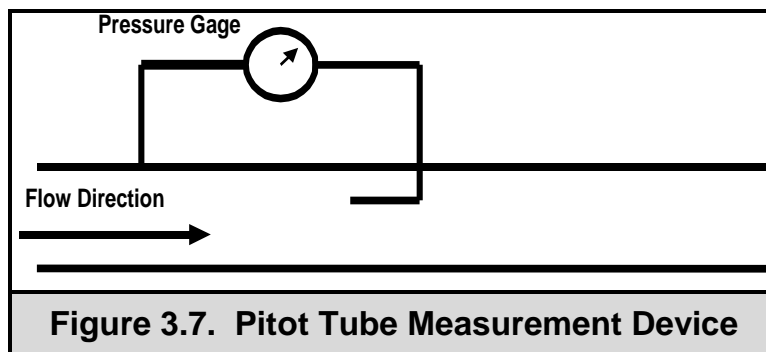

3.8. Header System Layout.

3.8.1. General. A header system can be constructed in three general configurations: branches, loops, or as a matrix. These layout options are shown in Figure 3.8. Branched systems consist of individual wells attached to a blower through the use of a header pipes and larger trunk lines. Branched systems are fairly common on small landfills where there are a limited number of wells. Looped systems ring the landfill and have the advantage of allowing LFG to be pulled from an individual well from more than one direction, bypassing blockages that may occur in the header line. Looped systems will often incorporate branches off of the main loop to allow collection of LFG from regions of the landfill that are not adjacent to the loop. A variation of the looped system is the matrix system. The design objectives of the header system are as follows:

- a. Create sufficient vacuum and flow from each extraction well to collect LFG and prevent its off-site migration;
- b. Move the LFG through the header system to the blower and flare; and
- c. Accomplish the first two objectives with the lowest possible capital and operating expenditures.

Pressure losses in the piping system are the result of friction losses and dynamic losses. Friction losses occur as LFG flows through the header pipes. Dynamic losses result from things such as changes in flow direction (elbows and tees), pipe constrictions, valves, filters, knock-out pots, and other restrictions within the piping network. The total system pressure loss is the sum of the friction and dynamic losses.

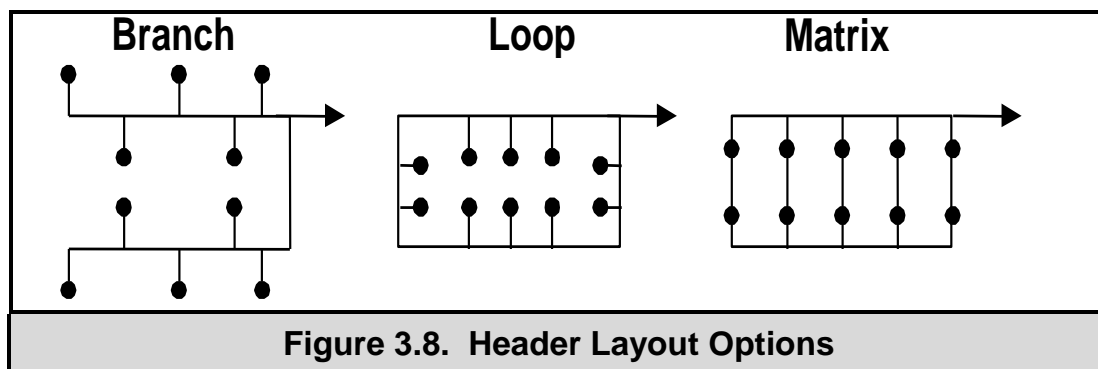

3.8.2. Design Considerations. It is important to consider overall system pneumatics prior to designing and selecting individual system components. A suggested approach is briefly summarized below (Brown and Clister 1993):

3.8.2.1. Step 1. Determine the size and depth of the landfill.

3.8.2.2. Step 2. Determine the type of waste within the landfill and its associated LFG generation rate.

3.8.2.3. Step 3. Estimate the radius of influence (ROI), and based on this ROI, lay out the LFG extraction wells and the header pipes.

3.8.2.4. Step 4. Develop a relationship for vacuum level versus LFG flow in the subsurface.

3.8.2.5. Step 5. Calculate the friction loss for the system components and piping for a range of flow rates.

3.8.2.6. Step 6. Develop a “system” curve by adding the frictional losses calculated in steps 4 and 5.

3.8.2.7. Step 7. Select a blower with an appropriate blower curve.

3.8.2.8. Step 8. Project the LFG flow rate and vacuum level from the simultaneous (graphical) solution of the blower curve and the system curve.

30 Apr 13

3.8.2.9. Step 9. Perform a network pressure analysis using the assumed well layout and equipment. Determine if the proposed system layout and selected blower provides adequate vacuum and flow to all portions of the landfill.

3.8.3. Subsurface Pressure Drop Losses. Subsurface losses are a function of the following:

- a. Waste permeability;
- b. Radius of influence of the well;
- c. Depth of waste;
- d. LFG extraction rate; and
- e. LFG generation rate.

For large municipal solid waste (MSW) landfills, subsurface losses can most accurately be quantified by performing pump tests. These tests determine the required vacuum needed to maintain a given flow rate. However, for older landfills such as those found at military installations, pump tests are not commonly performed as part of the design process. If pump tests are not performed, subsurface losses will need to be estimated based on existing conditions and past experience of the designer. Typically, the extraction well vacuum can be assumed to be 125 to 250 mm (5 to 10 inches) of water column.

3.8.4. Piping Frictional Pressure Drop Losses. Frictional pressure drop (also referred to as system head) losses associated with the piping system can be predicted for a range of flow rates. The most common method of predicting friction losses in straight pipes is to use the Darcy-Weisbach equation for incompressible fluids:

$$h_f = f (L/d) (v^2/2g)$$

where:

- h_f = friction loss [ft (m) of water]
- f = friction factor [dimensionless (dimensionless)]
- L = pipe length [ft (m)]
- d = inside pipe diameter [ft (m)]
- v = average velocity of the flow [ft/s (m/s)]
- g = gravitational acceleration [32.16 ft/s² (9.807 m/s²)]

Use of Darcy-Weisbach for gases is limited to systems with less than 10% compression without correction. The friction factor is a dimensionless number that has been determined experimentally for turbulent flow and depends on the relative roughness of the interior of the pipe and the Reynolds number. Tables and charts have been developed to predict friction losses for a range of pipe materials and diameters.

3.8.5. Pressure Drop Losses from Valves and Fittings. The following are two primary methods for estimating pressure drop losses through valves and fittings:

- a. Use of k values obtained from reference tables (where $k = fL/d$ and, therefore, $h_f = kv^2/2g$); and
- b. Use of reference values to convert pressure drop losses to equivalent lengths of straight pipe. For example, the resistance in a 150 mm (6 inch) standard elbow is equivalent to that of approximately 5 meters (16.5 feet) of 150 mm (6 inch) straight pipe.

3.8.6. Pressure Drop Losses at Flare Station. Condensate knock-out tanks, flame arrestors, and other equipment will typically result in total applied pressure drop losses of around 125 mm (5 inches) of water column. The flare, itself, will exert a back-pressure on the outlet side of the blower. This back-pressure form of pressure drop loss is typically around 250 mm (10 inches) of water column (wc).

3.8.7. System Analysis. The total conveyance system configuration pressure drop loss for blower vacuum sizing purposes is obtained by adding together the individual pressure drop losses associated with the subsurface, the straight pipe lengths, and the valves and fittings as described above for a given specified design LFG flow rate. This calculation is repeated for several LFG flow rates to establish a system curve. Note that these calculations are performed assuming that all system valves are fully open. Total piping system pressure drop losses can be computed manually or by using spreadsheet programs for simpler system configurations, while numerous software applications are available either publicly or for purchase that can be used for larger and more complex system configurations involving multiple branches, loops, etc.

3.8.7.1. Blower curves for design consideration are then superimposed on the overall system pressure drop curve for optimal selection. A specific blower should be selected based on mechanical, electrical, and pneumatic considerations. The blower curve is negatively sloped and the system curve is positively sloped. The predicted design LFG flow rate and vacuum level occurs at the intersection of these two curves, representing the simultaneous solution of two equations for optimal blower selection.

3.8.7.2. The projected LFG flow rate must exceed the design flow rate to allow flow control of multi-well systems by valves located at individual wellheads. This adjustment causes an increase in vacuum level at the blower and a decrease in the total flow rate as shown in Figure 3.9. The designer must verify the new LFG flow rate and vacuum/pressure are within the operating range of the blower. Therefore, the operating point must be on the blower curve above the intersection of the blower

curve and the system curve. For complex piping networks, it would be worthwhile to acquire software designed for this application.

3.8.8. Simplified Pneumatic Design Procedure. The following is a simplified design procedure taken from CES-Landtec Gas System Engineering Design Seminar courseware, and can be used to estimate system vacuum and pressure requirements for the blower.

3.8.8.1. Problem.

3.8.8.1.1. Estimate the following:

Total system flow _____ cubic feet per minute (cfm)
Fan pressure _____ inches of water column (in wc)

3.8.8.1.2. Based on the specified flow and pressure of the LFG collection system, select the “longest” pipe run (or path with highest resistance to LFG flow) and calculate the total pressure drop (TPD) from blower to extraction well:

Total pressure drop or fan pressure required = pipe friction + fitting losses + applied head losses.

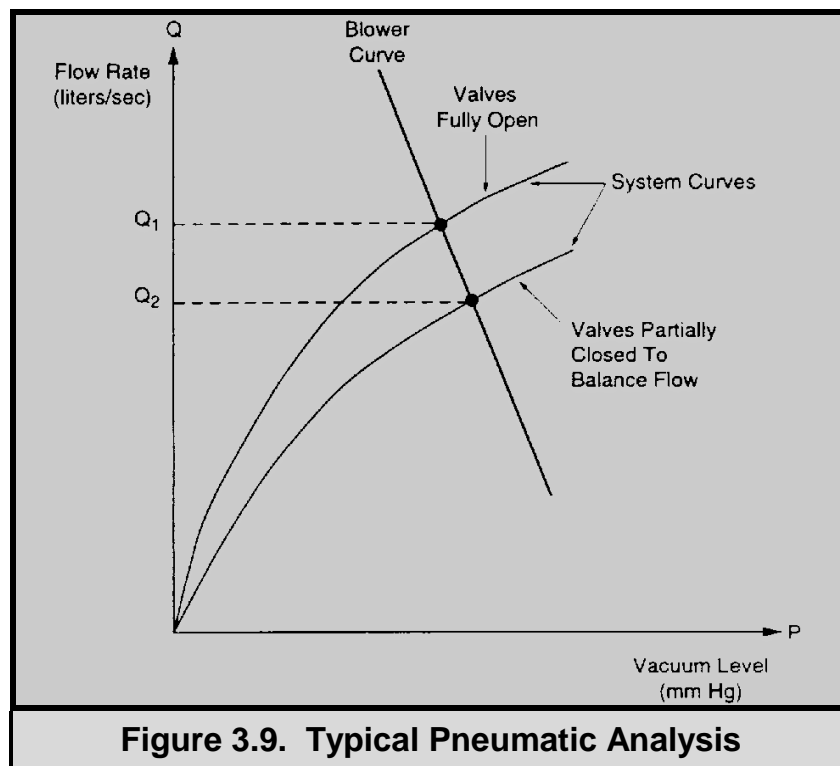

3.8.8.2. Determine Header Pipe Friction Loss. Pipe friction can be calculated by multiplying the effected length of pipe (feet) times the Darcy friction factor found on the Moody Diagram. The following equation represents Darcy's friction loss:

$$h_f = f (L/d) (v^2/2g)$$

where:

h_f = friction loss [ft (m) of fluid]
 f = friction factor [dimensionless (dimensionless)]
 L = pipe length [ft (m)]
 d = inside pipe diameter [ft (m)]
 v = average velocity of the flow [ft/s (m/s)]
 g_c = gravitational acceleration [32.16 ft/s² (9.807 m/s²)].
 $\Delta P = f (\rho_g/\rho_w) (L/d) (v^2/2g)$

where:

ΔP = pressure drop [in w.c./100 ft of pipe]
 ρ_g = LFG density [lb_m/ft³]
 ρ_w = water density [62.4 lb_m/ft³]
 L = 100 ft of pipe

and

$\Delta P = f (\rho_g/62.4 \text{ lb}_m/\text{ft}^3) (100/d) (v^2/2 * 32.16 \text{ ft/s}^2)$
 $\Delta P = f (\rho_g/(62.4 * 2 * 32.16 \text{ s}^2 \text{ lb}_m/\text{ft}^2)) (L/d) (v^2)$
 $\Delta P = 0.000249 \text{ s}^2 \text{ lb}_m/\text{ft}^2 f (\rho_g) (L/d) (v^2)$
 1 pound-force/square foot = 0.1922216 inch of water [4 °C]
 $\Delta P = 0.004789 \text{ in wc}/100 \text{ ft of pipe } f (\rho_g L v^2/d)$

Total $\Delta P_{\text{friction}}$ = header friction loss + branch friction loss

3.8.8.2.1. Select length _____ (ft) of affected header pipe (L)

3.8.8.2.2. Obtain specified blower flow rate (Q) _____ (cfm)

3.8.8.2.3. Determine pipe internal diameter as _____ in or (_____ ft)

3.8.8.2.4. Use Continuity Equation ($Q = vA$) to calculate velocity as _____ (linear ft/min) or _____ (ft/s). Where multiple branches of header pipe exist, the flow must be estimated in each branch.

3.8.8.2.5. Calculate Reynolds Number (N_{RE}) using the following equation:

$$N_{RE} = \frac{Dv\rho}{\mu_e}$$

where:

- D = pipe diameter (ft)
- v = fluid velocity (ft/s)
- ρ = fluid density (lb_m/ft³)
- μ_e = absolute viscosity (lb_m/ft s).

Reynolds Number = _____ Determine if the flow is turbulent or not.

3.8.8.2.6. Determine the relative roughness of pipe materials (ϵ/D) as _____

3.8.8.2.7. Use Moody Chart to determine the Darcy friction factor by determining the relative roughness:

$$f = \text{_____ (estimated)}$$

Substituting into Darcy's Equation:

$$\Delta P = \frac{(\rho)(f)(100)(v)^2(27.7)}{(144)(D)(64.4)}$$

$$\Delta P = \text{_____ (in wc) per 100 ft of pipe}$$

$$\text{Total friction loss for header pipe section} = (\text{Header pipe length} \text{ _____ ft} / 100) \times \text{_____ } \Delta P \text{ (in wc)} = \text{_____ in wc}$$

3.8.8.3. Determine Branch Pipe Friction Loss

3.8.8.3.1. Select length _____ (ft) of affected branch pipe (L)

3.8.8.3.2. Obtain specified branch flow rate (Q) _____ (cfm)

3.8.8.3.3. Determine pipe internal diameter as _____ in or (_____ ft)

3.8.8.3.4. Use Continuity Equation ($Q = vA$) to calculate velocity as _____ (linear ft/min) or _____ (ft/s). Where multiple branches exist, the flow must be estimated in each branch.

3.8.8.3.5. Calculate Reynolds Number (N_{RE}).

$N_{RE} =$ _____ Verify if the flow is turbulent or not.

3.8.8.3.6. Determine the relative roughness (ϵ/D) as _____

3.8.8.3.7. Use Moody Chart to determine the Darcy friction factor using the appropriate relative roughness curve:

$f =$ _____ (estimated)

Substituting into Darcy:

$$\Delta P = \frac{(\rho)(f)(100)(v)^2(27.7)}{(144)(D)(64.4)}$$

$\Delta P =$ _____ (or psi) per 100 ft of pipe

Total friction loss for branch pipe section = (header pipe length _____ ft / 100) \times _____ ΔP (in wc) = _____ in wc

Total friction loss = header _____ + branch _____ = _____ (in wc)

3.8.8.4. Calculate Valve and Fitting Losses. Locate all valves (ball, globe, angle etc.) and fittings (elbows, tees, reducers, etc.), which are in the "longest run" of piping and are points of resistance against flow from the extraction well to the blower.

Header pipe section (Darcy $\Delta P =$ _____ in wc/100 ft of pipe):

Fitting Type	No.	Size	Eq. Leng.	ΔP
Gate valve	_____	_____	_____	_____
Ball valve	_____	_____	_____	_____
Check valve	_____	_____	_____	_____
90° Standard elbow	_____	_____	_____	_____
45° Standard elbow	_____	_____	_____	_____
Standard tee	_____	_____	_____	_____

Branch pipe section (Darcy $\Delta P =$ _____ in wc/100 ft of pipe):

Fitting Type	No.	Size	Eq. Leng.	ΔP
Gate Valve	_____	_____	_____	_____
Ball Valve	_____	_____	_____	_____
Check Valve	_____	_____	_____	_____
90° Standard Elbow	_____	_____	_____	_____

EM 200-1-22

30 Apr 13

45° Standard Elbow



Standard Tee



Compute the pressure drop from these sources using the following methods:

3.8.8.5. Pressure Drop Due to Fittings. Using PVC or HDPE pipe manufacturer's data, obtain "equivalent length of straight pipe" data for fitting types and sizes used in the "longest run". By multiplying the Darcy friction factor for the effected section of piping (i.e., the header or the branch, times the effected fitting's "equivalent length of straight pipe"), the pressure drop across the fitting can be computed.

What follows is an example. Given: $\Delta P = 0.654$ in. w.c./100 ft of pipe*

$$\rho = 0.065 \text{ lb}_m/\text{ft}^3, \mu_e = 8.14 \times 10^{-6} \text{ lb}_m/\text{ft}\cdot\text{s}$$

for smooth plastic pipe. Find the pressure drop due to two 8-inch 90° elbows and three 8-inch tees in the header pipe section. The solution is as follows.

3.8.8.5.1. Obtain pipe manufacturer's "equivalent length of straight pipe" data for 8-inch elbow and 8-inch tee:

For 8-inch, 90° elbow, equivalent length = 33.3 ft

For 8-inch tee, with flow through run, equivalent length = 16.5 ft

3.8.8.5.2. Using $\Delta P = 0.654$ in wc/100 ft of pipe for $Q = 800$ cfm in 6 in (0.665 ft ID) pipe

$$\Delta p_{\text{elbows}} = (0.654 \text{ in wc}) \times (33.3 \text{ ft}/100 \text{ ft}) \times 2 = 0.436 \text{ in wc}$$

$$\Delta p_{\text{tees}} = (0.654 \text{ in wc}) \times (16.5 \text{ ft}/100 \text{ ft}) \times 3 = 0.323 \text{ in wc}$$

3.8.8.5.3. Compute $\Delta p_{\text{fittings}} = \Delta p_{\text{elbows}} + \Delta p_{\text{tees}}$

$$\Delta p_{\text{fittings}} = (0.436 \text{ in wc}) + (0.323 \text{ in wc}) = 0.759 \text{ in wc}$$

3.8.8.6. Pressure Drop Due to Valves. The previous method used for fittings can also be used for valves if equivalent length data is available. If equivalent length data is not available the pressure drop due to valves can be computed using the following equation:

* Computed using $Q = 800$ cfm, $D = 0.665$ ft.

$$\Delta P_{\text{valve}} = \left(\frac{\rho}{62.4} \right) \left(\frac{7.48 Q}{C_v} \right)^2$$

where:

- ρ = fluid density (lb_m/ft³)
- Q = flow through valve (ft³/min)
- C_v = valve or fitting coefficient

C_v can usually be obtained from the valve manufacturer's data. If the fitting coefficient must be computed, the following may be used:

$$C_v = \frac{29.9 d^2}{\sqrt{K}}$$

where:

- C_v = valve or fitting coefficient
- d = pipe diameter (in)
- K = resistance coefficient*

The following is an example. Given are the following: $Q = 800$ cfm; $\rho = 0.065$ lb_m/ft³; $d = 8$ in; $K = 106.5$, $62.4 =$ lb_m/ft³ for water Find ΔP_{valve} . Solution:

$$\Delta P_{\text{valve}} = \left(\frac{0.065 \text{ lb}_m/\text{ft}^3}{62.4} \right) \left(\frac{(7.48)(800 \text{ ft}^3/\text{min})}{\frac{29.9 (8 \text{ inch})^2}{\sqrt{106.5}}} \right)^2$$

$$\Delta P_{\text{valve}} = 1.09 \text{ in wc}$$

3.8.8.7. Calculate/Determine Applied Head Losses. Applied head losses for LFG control systems usually consist of the following:

- a. Extraction Well Vacuum _____ in wc (typical: 5–10 in wc)
- b. Flare Backpressure _____ in wc (typical: 10 in wc)
- c. Inlet Scrubber Vessel _____ in wc (typical: 2–5 in wc)

Total Applied Head Loss _____ in wc

3.8.8.8. Compute Total Head Loss from Extraction Well to Flare.

* Normally provided by fitting/valve manufacturer.

30 Apr 13

- a. Pipe Friction Head Losses _____ in wc
- b. Fitting and Valve Losses _____ in wc
- c. Applied Head Losses _____ in wc

Total Pressure Drop _____ in wc

3.9. Condensate Collection.

3.9.1. General.

3.9.1.1. An important element in the design of a LFG collection system is condensate management. Condensate is formed when warm LFG cools during transport or processing. LFG is typically warm and saturated when extracted from the moist environment of a landfill. As the LFG travels through the header pipes, it cools, which reduces its moisture holding capacity. The quantity of condensate generated in a LFG collection system is a function of how much LFG is being extracted, the vacuum or pressure being exerted on the LFG, and the magnitude of the temperature change. To prevent this water from blocking the header lines, low points in the piping system should have condensate knock-out sumps/tanks. A knock-out sump/tank is also typically located within the flare station to help prevent condensate from damaging the blower and other equipment located in the flare station. Knock-out sumps/tanks are specifically designed to promote the formation of liquid droplets and to separate these droplets from the LFG flow. Knock-out sumps/tanks are periodically pumped out. Various types of vessels can be used as knock-out sumps/tanks, including steel air holding vessels, pre-fabricated concrete sewer manholes, or large-diameter HDPE pipe sections. The key functionality of the knock-out tank/vessel is for the inlet pipe to be at a lower elevation than the outlet pipe in order to force an upward change in the vapor stream flow that will cause the entrained liquid condensate droplets to settle out to the bottom of the vessel. On large landfills, condensate collection can be automated with pumps and a piping system that carries the condensate to a central location where it can be stored and treated.

3.9.1.2. When laying out the header piping system, condensate collection should be an important consideration. If feasible, the header piping can follow surface water management berms. This will facilitate installation and maintenance of the header lines. Settlement of the waste must also be considered when laying out the header system. Excessive settlement may result in reverse grades that trap condensate and block the header lines. Additional condensate collection points should be placed in areas where a large amount of settlement is anticipated or where header lines have very little slope. Consideration should also be given to including LFG clean-out ports at strategic locations along the piping runs to allow for the flushing out of settled sediments or other materials that could plug the lines.

Clean-out ports also allow access for cameras and other equipment that may be needed to locate and address any line plugging or other maintenance problems.

3.9.2. Design Considerations. Some reasonable assumptions may be made when estimating condensate generation:

- a. LFG temperature at the wellhead is the warmest;
- b. The header pipe is installed below the frost line;
- c. LFG temperature depends on the distance traveled in the buried header pipe and the thermal conductivity of the header pipe; and
- d. LFG is completely saturated with water vapor.

The quantity of LFG condensate will vary throughout the year. Typically, during the winter, condensate formation will be at its highest. A psychrometric chart is a graphical representation of the thermodynamic properties of moist air. These tables can also be used to provide information on the amount of moisture in the LFG, even though LFG is generally a combination of methane and carbon dioxide. The following set of example calculations demonstrates how to estimate the quantity of condensate that will be generated.

3.9.2.1. Sample Calculation—Condensate Quantity. Estimate the rate of condensate generation for a section of header pipe of a LFG extraction system. The flow rate within the header pipe is 500 cfm (236 L/s). The system is under a vacuum of 40 in wc (91.4 kPa). This is equivalent to an absolute pressure of 0.9 atmospheres. The average ambient temperature of the soil surrounding the header pipe is 50°F (283 K). The solution is as follows:

Assume the LFG extracted from the landfill is 50% methane and 50% carbon dioxide and is at 100% relative humidity. Assume the LFG temperature within the pipe drops from 90°F (305 K) as it exits the landfill to 70°F (294 K) as it travels through the header pipe. The water holding capacity of the LFG will drop as the temperature of the LFG drops and can be estimated from a psychrometric chart.*

Conc. of water vapor = 0.030 kg water/kg LFG (at 305 K)

Conc. of water vapor = 0.015 kg water/kg LFG (at 294 K)

Subtracting gives:

Potential Condensate = 0.015 kg water/kg LFG

* Most psychrometric charts are created for higher pressures than are typically found in the header pipes of a LFG collection system. However, using these charts will generally not introduce large error when estimating condensate generation.

The ideal gas law can be used to estimate the density of the LFG passing through the header pipe:

$$\text{Density} = P M / R_U T$$

where:

P = absolute pressure within header pipe

M = molecular weight of gas

= 0.5 (molecular weight methane) + 0.5(molecular weight of carbon dioxide)

$$= 0.5 (16) + 0.5 (44) = 30 \text{ kg/kg-mole}$$

R_U = universal gas constant = 0.0821 L-atm/g-mole K

T = temperature.

$$\text{Density} = P M / R_U T = [(0.9 \text{ atm}) \times (30 \text{ kg/kg-mole})] / [(0.0821 \text{ L-atm/ g-mole K}) \times (294 \text{ K}) \times (1,000 \text{ g-mole/kg-mole})]$$

$$\text{Density of gas} = 1.12 \times 10^{-3} \text{ kg/L}$$

The flow rate times the concentration of the condensate yields the following condensate generation rate:

$$(0.015 \text{ kg water/kg gas}) \times (1.16 \times 10^{-3} \text{ kg/L}) \times (236 \text{ L/s}) \times (86,400 \text{ s/day}) \times (1 \text{ L/kg}) = 356 \text{ L/day}$$

3.9.2.2. Condensate Pumps. Several options exist for dealing with condensate. Condensate generated can be drained back into the landfill, if allowed by the approving regulatory agency. If the condensate must be collected and treated, two options exist: 1) the condensate can be collected in several large units located throughout the header system; or 2) the condensate can be periodically removed from several smaller knock-out sumps/tanks units using pumps and header pipes. In this scenario, the condensate will typically be stored in a larger, centralized holding tank prior to off-site disposal.

The condensate generation rate must be estimated to determine the condensate pump required. Typical condensate sump pumps are rated from 10-30 gpm with 1 to 2 inch diameter discharge piping. The preferred design velocity in the discharge is approximately 5 feet per second (between 2 and 8 feet per second). Friction losses in the piping are estimated by the Hazen-Williams method, valid only for water at typical ambient temperatures (40 to 75°F).

$$h_f = L (V / K C R_h^{0.63})^{1.852}$$

$$h_f = L (V / 1.318 C R_h^{0.63})^{1.852} \text{ (English units)}$$

where:

h_f = frictional head loss (ft H₂O)

L = pipe length (ft)

V = velocity (2 - 8 ft/s)

K = unit conversion factor = 1.318

C = Hazen-Williams roughness coefficient (80 – 150).

R_h = hydraulic radius (ft) = d (in)/48

Substituting:

$$V = Q / 448.8312 / \square (d/24)^2$$

$$V = 0.4085 Q / d^2$$

where:

Q = flow (gpm)

d = inside diameter of pipe (in)

$$h_f = L [(0.4085 Q / d^2) / 1.318 C (d/48)^{0.63}]^{1.852}$$

$$h_f = 10.458 L Q^{1.852} / C^{1.852} d^{4.87} \text{ (English units)}$$

$$h_f = L (V / K C R_h^{0.63})^{1.852}$$

$$h_f = L (V / 0.8492 C R_h^{0.63})^{1.852} \text{ (SI Units)}$$

where:

h_f = frictional head loss (m H₂O)

L = pipe length (m)

V = velocity (0.61 - 2.44 m/s)

K = unit conversion factor = 0.8492

C = Hazen-Williams roughness coefficient (80 – 150).

R_h = hydraulic radius (m) = d (m)/4

Substituting:

$$V = Q / \square (d/2)^2$$

$$V = 1.2732 Q / d^2$$

where:

Q = flow (m³/s)

30 Apr 13

$$d = \text{inside diameter of pipe (m)}$$

$$h_f = L [(1.2732 Q / d^2) / 0.8492 C (d/4)^{0.63}]^{1.852}$$

$$h_f = 10.672 L Q^{1.852} / C^{1.852} d^{4.87} \text{ (SI Units)}$$

3.9.2.2.1. Determine if longest run of condensate pipe is adequately sized, such that total head loss Δh_{total} is 10% of the condensate sump pump's specified pressure.

3.9.2.2.2. Use the Hazen-Williams equation to estimate head loss.

3.9.2.2.3. Compute the total head loss from pump to centralized holding tank (assume 20% loss due to fittings):

$$\Delta h_{\text{total}} = (h_f \text{ _____ ft/100 ft of pipe}) \times (\text{total length of run (ft)} + 20\%)$$

3.9.2.2.4. Determine if Δh_{total} is approximately 10% of specified pump pressure.

$$\Delta h_{\text{total}} \text{ _____ psia} < / = / > .10 \times h_{\text{pump}} \text{ _____ psia}$$

3.9.2.2.5. Other design considerations include the following:

a. Knock-out sumps/tanks should be located at the lowest elevation with respect to LFG header and branches from which condensate will be collected.

b. All condensate pipes should have a minimum 3% slope (if possible) to one of the knock-out sumps/tanks to promote drainage.

c. Condensate pipe should be run with air supply lines and LFG collection lines to provide better access for maintenance and protection of pipe (if PVC or HDPE is used).

d. Most condensate collection system sump pumps use compressed air versus electric powered. If a compressed air system is used, air lines and air compressors will need to be sized as part of design process.

e. Condensate collection systems are normally discharged to regional waste water treatment systems with an amendment to the operator's NPDES or sewer use permit. However, depending on the amount of condensate and its characteristics, pretreatment may be necessary prior to discharge (to a sewer system or navigable waterway). Smaller-scale skid-mounted water treatment systems incorporating various technologies (e.g., solids filtration, air stripping, granular activated carbon) are commercially available for this type of application.

3-10. Design Procedures for Passive Collection Systems.

3.10.1. General. The purpose of a passive LFG collection system is to prevent the build-up of pressure within the landfill to maintain the stability of the landfill cover and to prevent the off-site migration of LFG. Passive collection systems can be designed as blankets, wells, or trenches. Strict design procedures are

often not employed to design passive systems because they are typically placed on old and/or small landfills where the potential for LFG generation is small. Instead of using strict design procedures, rules of thumb are commonly applied in the design of passive LFG collection systems.

3.10.2. Passive Blanket Collection Systems. Because blanket LFG collection systems do not penetrate down into the waste layer, they are less effective than well systems in preventing the off-site migration of LFG. However, blanket LFG collection systems are effective at preventing the build-up of pressure beneath a cover system. Granular soil layers used as LFG collection blankets are typically 305 mm (12 inches) in thickness. If a geonet drainage layer is used it will typically be a geocomposite with a geotextile attached to one or both sides of the geonet. The geotextiles attached to the geonet prevent soil and waste from entering the geonet. The geotextiles also increase the frictional resistance at the drainage layer interfaces. Geotextiles can also be used as the LFG collection layer if the anticipated production of LFG is very small and the normal stresses acting on the geotextile are small. Thiel (1998) reported air transmissivity values for geotextiles. The following are the average flux values reported:

Geotextile Type	Transmissivity
540 g/m ² (16 oz/yd ²)	
Wet	$9.74 \times 10^{-7} \text{ m}^3/\text{s/m}$
Dry	$6.50 \times 10^{-6} \text{ m}^3/\text{s/m}$
680 g/m ² (24 oz/yd ²)	
Wet	$2.81 \times 10^{-6} \text{ m}^3/\text{s/m}$
Dry	$1.87 \times 10^{-6} \text{ m}^3/\text{s/m}$

3.10.2.1. Design Procedures for Passive Blanket Collection Systems. If there is a potential for the build-up of LFG pressure beneath a geomembrane barrier layer, slope stability becomes a concern and a more rigorous design procedure should be implemented. The general steps required when considering pressure in the design of a passive LFG collection blanket are as follows:

- a. Estimate the maximum LFG flux that needs to be removed from below the landfill cover.
- b. Perform slope stability analyses to estimate the pressure at which slope instability will result.
- c. Design a vent system below the cover that will evacuate the assumed LFG flux and prevent the build-up of pressure beneath the geomembrane.

If the LFG collection layer is a granular material, it is reasonable to assume that the granular material will be holding a certain amount of capillary water either due to rain during construction or from condensate collecting beneath the barrier layer. The

reduction in permeability due to partial saturation of the layer can be estimated using the Brooks and Corey relationship. Based on preliminary experimentation, Thiel (1998) makes the following recommendations on the field-gas permeability of granular collection layers:

- a. For fine sands containing less than 10–15 percent fines, the field-gas permeability can be taken as the dry-gas permeability reduced by a factor of 5 to 10 to account for the presence of field-moisture.
- b. For clean medium and coarse sands, the field-gas permeability can be taken as the dry-gas permeability reduced by a factor of two to account for the presence of field-moisture.
- c. For gravel construction LFG collection layers, there will be little or no measurable reduction in permeability due to water retained within the pore spaces of the gravel.

Calculations and experimental evidence from the literature suggest that LFG flow rates in passive blanket collection layers are generally expected to be laminar and Darcy's law applies.

3.10.2.2. Maximum Acceptable LFG Pressure. Thiel (1998) outlines a design methodology for estimating the slope stability for the case where LFG pressure builds up beneath the barrier layer. The following equation can be used to estimate the maximum acceptable pressure beneath the geomembrane barrier layer:

$$\text{Factor of Safety} = [(H\gamma \cos B - \mu_g) \tan \phi] / H\gamma \sin B$$

where:

- H = height of cover soil (m)
- γ = cover soil density (kN/m^3)
- μ_g = LFG pressure (kPa)
- B = slope angle.

3.10.3. Design Considerations for Passive Well Collection Systems. Passive LFG collection wells are typically spaced approximately 60 m (200 ft) apart. Additional wells will be required if perimeter monitoring probes indicate the methane concentration exceeds the regulatory limit for the site. Vertical risers should also be located at high points in the collection system within the landfill.

3.11. Design Procedures for Active Well Collection Systems.

3.11.1. General. Spacing of LFG collection wells for active systems is highly dependent on site-specific variables such as waste density, waste moisture content,

waste thickness, well design, and cap configuration. The following methods have been used to determine the well spacing of LFG collection systems:

- a. Cylinder method: This is a popular approach used by designers, and involves estimating the amount of LFG being produced within the ROI of an extraction well.
- b. Field pump tests: The designer uses pump test results to obtain data to identify the site-specific zone of influence (ZOI) of extraction wells.
- c. Prescriptive/regulatory criteria: Some states have regulatory requirements related to LFG vent spacing. For example, the Wisconsin Department of Natural Resources (WDNR) requires all designs to use a maximum of 150-foot ROI unless a pump test is conducted.
- d. Rule of thumb criteria: This method relies on past experience to aid in the layout of the LFG collection wells. Some designers correlate LFG vent well spacing to the depth of the waste. Typically, wells are spaced no farther apart than three times the depth of the waste, with a maximum acceptable spacing of 300 ft.

Whichever design method is used, the designer must ensure LFG is captured from the entire area of the landfill and off-site migration is prevented.

3.11.1.1. Cylinder Method. This approach assumes LFG generated from within a cylinder of a specified ROI is removed by the well and that no leakage from the atmosphere enters the landfill (Emcon, 1980). This method is most appropriate for landfills with low-permeability covers. Figure 3.10 shows a typical layout for wells designed using the cylinder method. The following equations can be used to apply the cylinder method:

3.11.1.1.1. Flow Rate for Entire Landfill. The following equation can be used to estimate the total amount of LFG being generated from within a landfill:

$$Q_{\text{tot}} = (V)(D)(G)/(\text{percent methane in LFG})$$

where:

- V = volume of waste
- D = density of waste
- G = methane production rate.

Typically, methane represents approximately 30% to 55% of the total volume of LFG generated from a landfill. Since the G term is only an estimate of the amount of methane generated, to determine the total LFG flow rate, divide $(V)(D)(G)$ by the percent methane.

3.11.1.1.2. Determine Flow Rates from Each Well (Cylinder Method). The flow rate from individual wells can be determined by assuming a ROI and estimating the amount of LFG generated from within this radius using the methane production rate discussed above:

$$Q = \pi (R^2 - r^2) (t)(D)(G)/(\% \text{ methane})$$

where:

- Q = methane flow rate
- R = radius of influence
- r = borehole radius
- t = waste thickness
- D = density of waste
- G = methane production rate.

As a rough approximation, the total flow from all wells as determined by the cylinder method, must be greater than or equal to Q_{tot} (calculated above).

$$\Sigma Q \text{ from each well} \geq Q_{\text{tot}}$$

3.11.1.1.3. Determine pressure drop required at each well to maintain assumed ROI. The following equation is used to estimate the vacuum required to prevent the build-up of pressure within the landfill due to the generation of LFG:

$$\Delta P = \mu G_{\text{tot}} D [R^2 \ln(R/r) + (r^2/2) - (R^2/2)] / 2 K_s$$

where:

- ΔP = pressure difference from the radius of influence to the LFG vent
- R = radius of influence
- r = radius of borehole
- μ = absolute viscosity of the gas
- K_s = apparent permeability of the refuse
- D = density of the refuse
- G_{tot} = Total LFG production rate = $G/(\% \text{ methane})$

In order to ensure that LFG generated within the landfill does not escape through the subsurface or through the cover, the vacuum used during full-scale operations will often be somewhat greater than the value calculated above. The required vacuum is often set in the field based on data collected from LFG monitoring probes located at the perimeter of the landfill. These perimeter monitoring probes are typically monitored for vacuum and methane content to verify adequate capture.

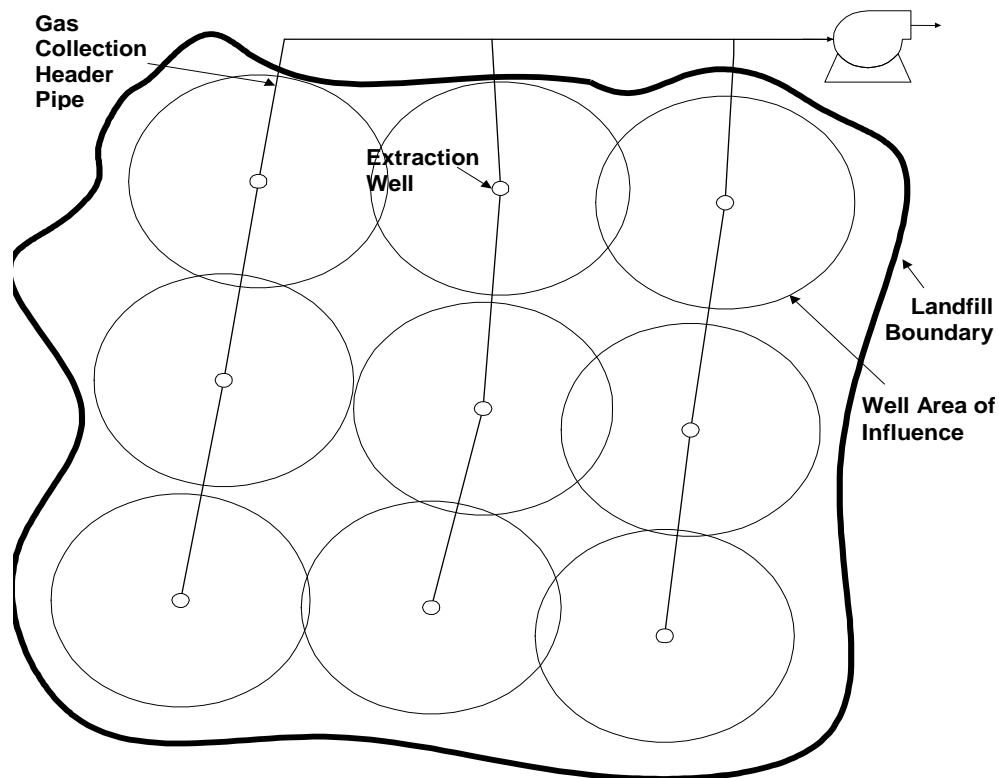

Figure 3.10. Typical Extraction Well Layout.

3.11.1.2. LFG Generation Rate. The equation shown in the previous paragraph requires the input of a LFG generation rate. Methods to estimate the rate of methane generation were discussed in Chapter 2 of this EM. Estimates of methane LFG generation rates have also been reported by numerous authors. Table 3.1 is a summary of reported values. It should be noted that the values reported in the table are representative of MSW landfills during their most active periods of LFG production. LFG generation rates will decline as the waste ages. It should also be noted that methane is only one component of the LFG being generated by a landfill. To conservatively estimate total LFG production the values shown in Table 3.1 should be doubled.

3.11.2. Other Design Considerations. The maximum LFG extraction rate from any well is limited by the available vacuum and air intrusion into the waste (i.e., over-pull). Over-pull can result in oxygen being drawn into the landfill, which in turn creates aerobic conditions and kills off the methane producing bacteria. Landfill fires can also occur when oxygen is drawn into the landfill. Additional items to keep in mind when establishing spacing of LFG wells:

- a. Shallower LFG wells have a smaller ZOI.

30 Apr 13

b. Extraction systems, whose primary purpose is migration control, should have a closer well spacing near the perimeter to minimize the potential for off-site migration.

c. Access to proposed well locations by drill rigs must be considered when laying out the LFG collection system.

d. The volume and cost for disposal of drill rig waste must be accounted for in the design.

Table 3.1. LFG Generation	
Methane LFG Generation Rate $\text{m}^3/(\text{kg}\cdot\text{day})$	Reference
3.29 to 20.1×10^{-6}	Bagchi, Amalendu, (1990). "Design, Construction, and Monitoring of Sanitary Landfills," John Wiley, New York
3.52 to 21.1×10^{-6}	Stecker, Phillip, (1989). "Active Landfill Gas Recovery Systems," University of Wisconsin Sanitary Landfill Leachate and Gas Management Seminar, Madison, WI, December 4-7.
3.56 to 20.5×10^{-6}	Emcon Associates (1980). "Methane Generation and Recovery from Landfills," Ann Arbor Science, Ann Arbor, Michigan
1.76 to 5.28×10^{-6}	Farquhar, Grahame J., (1989). "Factors Influencing Landfill Gas Recovery," University of Wisconsin Sanitary Landfill Leachate and Gas Management Seminar, Madison, WI, December 4-7.
1.76 to 7.04×10^{-6}	Ham, Robert K., (1989). "Landfill Gas Generation: Compositions, Quantities, Field Test Procedures and Uncertainty," University of Wisconsin Sanitary Landfill Leachate and Gas Management Seminar, Madison, WI, December 4-7.
27.4 to 54.8×10^{-6}	Ham, Robert K., Barlaz, Morton A., (1987). "Measurement and Prediction of Landfill Gas Quality and Quantity," ISWA International Symposium, "Process, Technology and Environmental Impact of Sanitary Landfills," Cagliari, Sardinia, Italy, October 20-23.
13.7 to 21.9×10^{-6}	Pohland, Frederick G., Harper, Stephen R. (1986), "Critical Review and Summary of Leachate and Gas Production from Landfills," USEPA/600/2-86/073. USEPA, Cincinnati, OH.

CHAPTER 4 Design of Landfill Gas Treatment Systems

4.1. Introduction. Other resources for LFG collection system design include AP-42, USEPA (1999a), USEPA (2005a), and BCME (2010). Because of the high energy content of the methane component in landfill gas (LFG) and its relatively low comparative cost, flaring (i.e., flame combustion) is the most common treatment method for landfill gases vented from the waste area. A blower/flare station is typically composed of the following components:

- a. Structure;
- b. Blower;
- c. Flare;
- d. Flame arrestor;
- e. Flow metering;
- f. Piping and valves; and
- g. Electrical controls.

4.2. Structure. The blower/flare station should be located on native soil and accessible by vehicles to allow for flare and blower maintenance. For inclement climates, the basic equipment except the flare should be located within an enclosed structure. It should be noted that an enclosed blower/flare structure is classified as a Class I, Division I, and Group D Hazardous Location as defined by the National Electric Code (NEC). Therefore, equipment housed in an enclosed structure must be rated for this hazard classification. In mild climates, the equipment does not have to be located within an enclosed structure. For most sites, a security fence should surround the flare station. Within the station, there should be ample access to units for maintenance activities and replacement.

4.3. Blower. The blower must be able to function under a range of conditions that may result due to changes in LFG composition and flow rate. The blower applies the required vacuum on the LFG collection system and supplies the required discharge pressure for the flare. The amount of vacuum required depends on the size of the LFG collection system and typically varies from 40 to 60 inches of water column. The amount of blower discharge pressure required is governed by the flare burner configuration and typically varies from 10 to 20 inches of water column. Blowers may be operated in series to provide additive pressure/vacuum delivery, or in parallel to provide additive flow rate capacity, to meet system requirements. Generally, the suction side vacuum requirements include the design vacuum to be achieved at the extraction wells plus frictional pressure drop and other system component pressure drop resistances (e.g., valves). On the pressure side of the blower, pressure drops include frictional losses from the discharge piping and back-pressures generated by the flame arrestor, flare, and other components. The

pressure/horsepower sizing of the blower must account for the combination of these suction and pressure side resistance losses. LFG collection systems generally use centrifugal or positive displacement type blowers.

4.3.1. Centrifugal Blowers. These blowers are typically employed for lower vacuum applications requiring less than 80 inches of water vacuum. Centrifugal blowers are compact and produce an oil-free airflow. A multi-stage impeller creates pressure through the use of centrifugal force. A unit of air enters the impeller and fills the space between two of the rotating vanes. The air is thrust outward toward the casing, but then is turned back to another area of the rotating impeller. This process continues regenerating the pressure many times until the air reaches the outlet.

4.3.2. Rotary Lobe Blowers. This type of positive displacement blower is typically used for a medium range of vacuum levels (roughly 20 to 180 inches of water vacuum). During operation of these blowers, a pair of matched impellers rotates in opposite directions, trap a volume of gas at the inlet, and move it around the perimeter to the outlet. Timing gears that are keyed into the shaft synchronize rotation of the impellers. Oil seals are required to avoid contaminating the air stream with lubricating oil. These seals must be chemically compatible with the site contaminants. When a belt drive is employed, blower speed may be regulated by changing the diameter of one or both sheaves or by using a variable speed motor.

4.3.3. Blower Summary. Centrifugal blowers are more commonly used due to their greater flexibility in adjusting to variable flow rates and lower long-term maintenance costs. Centrifugal blowers also result in power consumption savings when the flow rate is reduced due to the proportional decrease in horsepower. A comparison of centrifugal and positive displacement blowers is shown in the Table 4.1.

4.3.3.1. Since LFG may contain particulates and aqueous vapor that may be corrosive, a protective silicone spray coating should be applied to all blower parts in contact with the gas. Flexible connections are recommended on both inlet and outlet sides of a blower to adsorb vibrations during operation. In addition, the blower motor should be explosion-proof and suitable for Class I, Division I, Group D, and Hazardous Locations. Both a temperature and vacuum/pressure gage should be included on each side of the blower. An airflow meter (e.g., pitot tube, orifice plate, or sample port for portable anemometer) should also be located on the inlet side of the blower. These instruments aid in operating the blowers within the manufacturer's recommendations, as well as the system at the design flow rate.

4.3.3.2. Depending on the potential health hazards that could result from a mechanical failure and subsurface migration of LFG, a back-up blower is sometimes provided in the event the primary unit fails or is out of service for maintenance. In

addition, design redundancy provides greater operating flexibility. Stand-by units not in service should be isolated from the LFG flow stream by butterfly or gate valves (or redundant ball valves). These valves, when closed, will prevent accumulation of condensate from the LFG in the piping and blower casing. Butterfly or gate valves can also be used to adjust the flow rate and allow removal of the unit for maintenance.

Table 4.1. Blower Type Comparison.	
Centrifugal	Positive Displacement
Lower long-term maintenance	Higher long-term maintenance
Direct driven (Generally)	Belt driven
Ample tolerances, little wear and tear of internal parts	Close tolerance of internal parts, more wear and tear. SAFETY NOTE: As parts wear, there is a possibility of metal to metal contact which could produce a spark with enough energy to ignite a flammable atmosphere.
Bearings mounted outboard of blower housing, no chance that discharged gas will be contaminated	Internally lubricated, more chance that discharged gas will be contaminated
Can deliver variable volume at constant speed	Delivers constant volume at constant speed
Less power used for lower flows	No power savings for lower flows, vent excess flows unless you change the speed at which the blower rotates through change in sheave size or use a VFD motor
Deliver relatively constant pressure at constant speed	Deliver variable pressure at constant speed
Less noise, easier to muffle	More noise, difficult to silence
Since horsepower is in direct proportion to flow, ammeter with volumetric scale can be used to approximate flow	Measurement of flow with an ammeter is not reliable, more expensive meter may be required
Produces a smooth, non-pulsating flow when operating at any point beyond the surge range	Produces a pulsating flow beyond the surge range

4.4. LFG Energy Recovery Systems.

4.4.1. Recovery Options. For large municipal solid waste (MSW) landfills, LFG is being developed as an alternative energy resource. Generally, the collection of LFG for energy recovery purposes has been limited to large landfills with over one million tons of solid waste in place. Landfills associated with Army installations are typically smaller in size, and often do not contain waste types conducive to the production of large enough quantities of methane to be economically recovered for use as an energy source. Energy recovery options are briefly discussed for the reader's information, since this topic is too extensive for thorough discussion in this

EM. Electricity generated from LFG conversions can either be used on-site or sold to the local power grid.

The following approaches can be used for LFG energy recovery:

- a. Direct use as a fuel for a gas turbine engine, boiler, or other heating and combustion equipment (see below);
- b. Energy source for the generation of electricity by the operation of a gas turbine, an internal combustion engine, microturbines (for smaller volumes of LFG generation), and external engines;
- c. Direct use as a fuel in a boiler, where the generated steam can drive a turbine/generator set up to produce electricity; and
- d. Upgrade of the LFG to pipeline quality for delivery to a utility distribution system for use.

4.4.1.1. Typical LFG contains approximately 500 Btu per standard cubic foot (4,450 K cal/m³) of energy, whereas pipeline-quality natural gas contains 1,000 Btu/scf (8,900 K cal/m³). The energy content of LFG varies widely depending upon the performance of the collection system and the stage of decomposition within the landfill. Active extraction systems that draw excessive amounts of atmospheric air into the subsurface can also dilute influent gas streams.

4.4.1.2. Besides electricity generation, LFG can be used as a replacement for other fuel use (e.g., natural gas, coal, fuel oil) in heating and combustion equipment, such as boilers (most common use), evaporators, dryers, kilns, blast furnaces, and process heaters. This type of equipment may be present on an Army installation or used by local manufacturing facilities, which may then represent a viable application or market for LFG generation. Direct use of LFG accounts for approximately one-third of the operational projects implemented in the United States. LFG is a medium heating value gas with a heating value (see above) that is approximately one-half of natural gas. As such, the LFG volume usage requirement is twice that of natural gas, which dictates the need to modify fuel trains and burners on the affected equipment for conversion planning purposes. Equipment for retrofitting boilers and other equipment to burn LFG is commercially available, proven, and not overly complex. The increased gas flow requirements do not have an appreciable effect on the design and operation of boiler components downstream of the burner, but engineering considerations are site-specific and must be well planned prior to proceeding with a conversion. Refer to Dedek et. al. (2010) for further information regarding LFG to energy conversion applications and technologies, as well as current projects and market analysis.

4.4.2. USEPA LFG to Energy Support. The USEPA has established the Landfill Methane Outreach Program (LMOP) to promote and facilitate LFG to energy

projects, which has a website address of <http://www.epa.gov/lmop>. LMOP has resources devoted to LFG conversion to energy projects. The primary mission of LMOP is to develop partnerships with public and private sector entities. Services provided by LMOP include performing methane emission and economic viability analyses for entities interested in pursuing LFG to energy projects. Contacts can also be provided with local utilities, municipalities, and/or manufacturing associations that are known or potentially viable markets for energy purchase or direct LFG use. LMOP has developed the “LFG Energy Project Assessment Tool” to support potential landfill LFG to energy conversion projects, and will either perform the analyses for a requesting entity or provide these tools to the entity to self-perform the analysis. A USEPA webinar on this assessment tool titled “Superfund Landfill Methane Potential Assessment” is available on its website <http://www.clu-in.com>.

4.4.3. Ongoing Army LFG to Energy Projects.

4.4.3.1. As discussed above, most landfills associated with Army installations do not generate enough methane to support typical LFG to energy conversion applications. To pursue more LFG conversion applications, a project was initiated through the SERDP/ESTCP to evaluate the use of a new microturbine product developed by Flex Energy at DOD sites. The microturbine unit uses a proprietary flameless catalytic combustion system to oxidize and destroy hydrocarbons in the waste fuel stream before entering the turbine. Utilizing the catalytic process allows the Flex microturbine to operate on fuel gas that is below the typical requirements for combustion at only 1.5% of the heat content of natural gas. This new microturbine product was specifically designed for smaller methane generation landfills to provide electricity that can be used at an operating DOD installation. An ongoing field demonstration at the Army’s Fort Benning installation was also initiated in 2011. The SERDP/ESTCP project also involved compilation of historical landfill data and development of a database for approximately 470 DOD landfills. For landfills with sufficient available historical information, 46 Army landfills were identified as being potential candidates for application of the Flex microturbine, depending on successful completion of the Fort Benning field study. Further details and contact information for the SERDP/ESTCP microturbine field study and accompanying DOD LFG to energy application candidates can be found at the website <http://www.serdp.org/Program-Areas/Energy-and-Water/Energy/Distributed-Generation/EW-200823>.

4.4.3.2. The Army also initiated its own LFG to energy evaluation project. A contract was awarded for the “Feasibility Study of Landfill Methane Gas Capture”. The objective of the task order awarded in 2012 was to determine the feasibility of landfill methane gas capture for energy conversion at various Active Army Installations across the continental United States. Ten active Army installations were selected for this feasibility study. Tasks to be completed as part of the contract work scope included the compilation of historical landfill disposal and construction

information, development of methodology to evaluate the potential to collect methane for purposes of energy conversion, and performance of field studies as needed to measure methane recovery rates at candidate landfills. This Army LFG to energy evaluation project was being administered by the USACE Engineering and Support Center (Huntsville, Alabama).

4.5. Flares. Two types of flare systems are generally used for LFG collection and treatment systems: open-flame flares and enclosed flares. Each flare type has advantages and disadvantages. Both types of flares have been used for LFG treatment.

4.5.1. Open-Flame Flare. An open-flame flare or candle-stick flare represents the first generation of flares. The open-flame flare was mainly used for safe disposal of combustible gas when air emission control was not a high priority. Open-flame flare design and the conditions necessary to achieve 98 percent reduction of total hydrocarbon are specified in 40 CFR Part 60.18. The advantages of open-flame flares are:

- a. Simple design (since combustion control is not possible);
- b. Ease of construction;
- c. Least costly method for mitigating LFG ; and
- d. Flares can be located at ground level or elevated.

The major disadvantages of open-flame flares are:

- a. Lack of flexibility to allow temperature control, air control, or sampling of combustion products due to its basic design; and
- b. Sampling LFG from open-flame flares is difficult. Sample probes placed too close to the flame will measure high carbon dioxide and hydrocarbon levels, while measurements taken further away from the flame are diluted unpredictably by air.

4.5.2. Enclosed Flares. Enclosed flares differ from open flares in that both LFG and airflows are controlled. While a blower pushes LFG through the flame arrestor and burner tips, the flare stack pulls or drafts air through dampers and around burner tips. The stack acts as a chimney, so its height and diameter are critical in developing sufficient draft and residence time for efficient operation. Enclosed flares are more commonly used than open flares in LFG applications for two reasons:

- a. They provide a simple means of hiding the flame (i.e., neighbor friendly).
- b. Periodic sampling of these flares can be conducted to ensure the required rate of emissions reduction is being achieved.

A typical schematic of an enclosed flare system is shown in Figure 4.1. An enclosed flare burns LFG in a controlled environment to destroy harmful constituents. The basic flare unit consists of a multi-orifice burner and burner chamber enclosed in a stack containing refractory insulation. Usually the stack height is greater than the flame height so the flame is not visible to the public. The typical stack height is 20 to 30 feet. Exit gas temperature is measured by thermocouple and is recorded at the flare control panel. An automatic combustion air control system (dampers) operates based on the temperature controller. The dampers provide ambient air to the flare interior for combustion oxygen and for controlling the exit gas temperature. Sampling ports are located in the walls near the top of the stack where emissions monitoring are performed. A built-in staircase and platform is usually provided for access to the sampling areas. A flare will include an electric pilot ignition system. The pilot ignition system requires auxiliary fuel; therefore, a small propane tank must be located near the flare to serve as pilot fuel. An enclosed flare should be equipped with a purge blower as a safety feature that is used during the start cycle to purge trace LFG from the flare prior to ignition.

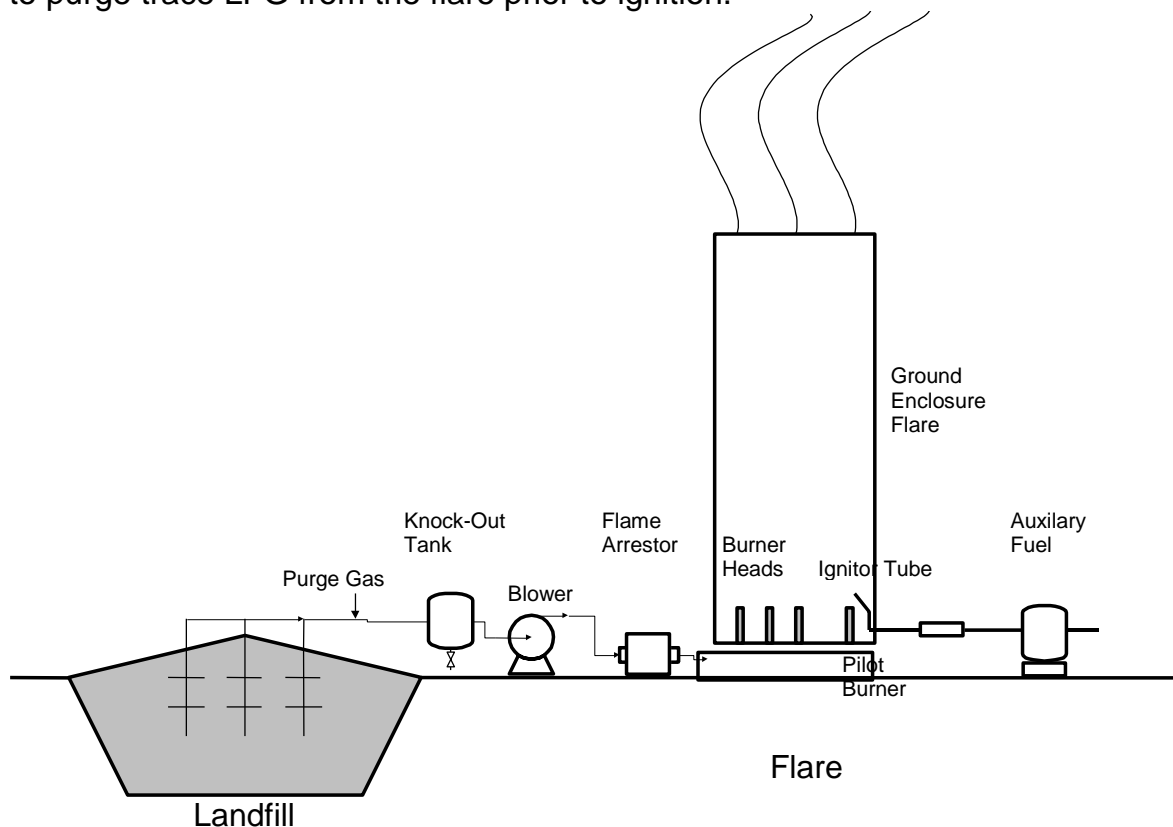

Figure 4.1. Enclosed Flare Schematic.

4.5.3. Flare Design Criteria. The basic flare unit consists of the following components:

- a. Multi-orifice burner;

- b. Burner chamber;
- c. Automatic combustion air control system (dampers);
- d. Electric pilot ignition system;
- e. Sampling ports;
- f. Flare control panel;
- g. Temperature controller (flare stack high temperature interlock);
- h. Flame arrestor; and
- i. Emission control.

4.5.3.1. The elements of combustion that must be addressed in the design of a LFG flare are:

- a. Residence time;
- b. Operating temperature;
- c. Turbulence; and
- d. Oxygen concentration.

4.5.3.2. These elements are interrelated and, to some extent, dependent on each other. Adequate time must be available for complete combustion. The temperature must be high enough to ignite the gas and allow combustion of the mixture of fuel and oxygen. The residence time in a combustor must be sufficient for hydrocarbons to react with the oxygen. Residence times for volatile organic compounds (VOCs) can vary from 0.25 to 2.0 seconds. Solid particles, such as carbon, may require as long as five seconds for complete destruction.

4.5.3.3. The operating temperature of a combustion unit depends upon the material to be combusted. The temperature should be about 148 to 260°C (300 to 500°F) above the auto-ignition temperature of the LFG. Since methane has an auto-ignition temperature of 540-760°C (1000-1400°F), a minimum operating temperature of 760°C (1400°F) is often specified. A temperature that is too high may cause refractory insulation damage, while a temperature that is too low may result in the production of excess carbon monoxide and unburned hydrocarbons. Flare stack high and low temperature alarms should be provided, as well as a high-high interlock to shutdown the gas supply to the flare stack in the event of an excessively high temperature. Methane has a flame temperature of 1,880°C (3416°F) when no excess air is present to cool the gas.

4.5.3.4. There must be enough turbulence to mix the fuel and oxygen, and enough oxygen to support combustion. Mixing the LFG and air at the burner tip is critical to proper operation of the flare. Proper mixing and adequate turbulence will create a uniform mix of LFG and air in the combustion zone, whereas improper

mixing will result in flue gas stratification, which contributes to high emissions and unstable operation.

4.5.3.5. Operating at high flow rates and tip velocities requires flame stabilizers to prevent the flame from extinguishing itself. Windshields allow the flame to establish itself and resist high wind conditions. Automatic pilots sense the LFG flame and automatically relight the flare when necessary.

4.5.3.6. A gas flow meter system is necessary to measure LFG flow to the flare. The gas flow should indicate both current flow and accumulated flow. For data storage, it is recommended that digital storage be used instead of paper recorder to avoid maintenance problems. The total volumetric flow rate to the flame must be carefully controlled to prevent flashback problems and to avoid flame instability. A gas barrier or a stack seal is sometimes used just below the flare head to impede the flow of air into the flare gas network.

4.5.3.7. Thermocouples are used to monitor the flame in open and elevated flares. For enclosed flares, ultraviolet (UV)-type flame detectors should be used. The UV flame detectors can detect instantaneous flame failure so the inlet valve can be shut before the vessel fills up with unburned gas.

4.5.4. Flare Operating Criteria. The design and selection of landfill flares depends upon the required design and operating objectives. In any case, flares should be designed and manufactured to provide the minimum operating temperature under a range of LFG compositions and flow rates. Typical flare air emission and operating parameters that may require periodic sampling or installation of continuous stack monitoring instrumentation include the following:

- a. Reactive organic gas (ROG);
- b. Exit gas temperature;
- c. Nitrogen oxides (NO_x);
- d. Residence time;
- e. Sulfur oxides (SO_x);
- f. Carbon monoxide (CO); and
- g. PM10 (particulate matter of aerodynamic diameter smaller than or equal to a nominal 10 microns).

4.6. Condensate Collection Equipment. LFG is typically saturated with water vapor. As the LFG cools in the extraction system piping, the vapor condenses into droplets that eventually combine into condensate. Accumulations of condensate in LFG pipelines can obstruct the flow of gas. Therefore, LFG condensate must be removed in a controlled manner. Condensate control is required irrespective of how

great a vacuum is imposed on the collection system. Knock-out tanks are normally used to remove condensate from LFG entering the flare station. Low points in collector piping should have barometric drip legs installed and multiple arrays of piping should meet at common condensate knock-out tanks. Environmental regulations often require the treatment or off-site disposal of collected condensate.

4.7. Auxiliary Fuel. Auxiliary fuel is required if the LFG methane content is too low to burn by itself. The operating temperature is a function of gas composition and flow rate. Unfortunately, LFG composition and flow rate are variable and somewhat unpredictable. LFG typically produces a maximum of 500 BTUs per cubic foot when it contains 50% methane. Natural gas produces approximately 1,033 BTUs per cubic foot. Flares are manufactured that are able to provide the minimum operating temperature under a range of LFG compositions and flow rates. However, when the BTU loading derived from LFG is outside the flare design range, auxiliary fuel is required.

4.8. Flame Arrestor. Another important unit independent from the flare is the flame arrestor that is installed in the LFG inlet line. The function of the flame arrestor is to prevent the propagation of flame into the header pipes. The flame arrestor is packed with a quenching media that is durable, resistant to oxidation, and easy to clean. Pressure gauges and sampling ports must be installed on each side of the flame arrestor to indicate the degree of clogging and whether removal for cleaning is required. Proper sealing of the flame arrestor in the housing is essential. Since a flame arrestor requires periodic factory cleaning, a stand-by flame arrestor should be kept on-site for use during maintenance activities. Also, in selecting a flame arrestor, an easily removable design should be used to facilitate cleaning and inspection. The flame arrestor housing is generally carbon or stainless steel.

4.9. Flow Metering. An important additional piece of equipment at a blower/flare station is a gas flow metering system. LFG flow rate information is the basis for controlling operation of the extraction and treatment system. The gas flow meter should display current and total gas flow.

4.10. Piping and Valves. Cast iron or ductile iron materials are recommended. Flanged piping, valves, and fittings are also recommended. Hand-operated, wafer style butterfly valves are easiest to install and use for blower adjustments. Flexible connections are typically used at both the inlet and outlet sides of the blower to absorb vibrations during operation in order to prevent damage to piping and other components.

4.11. Electrical Design Requirements.

4.11.1. General. The electrical system planning and design should consider materials, equipment, and installation of all electrical components. A detailed

discussion of electrical system planning is presented in EM 200-2-18, "Soil Vapor Extraction and Bioventing". The following paragraphs outline some of the electrical control requirements unique to LFG flare systems.

4.11.2. Electric Controls. Necessary blower controls include:

- a. MANUAL/AUTO/OFF selector switch;
- b. Failure light;
- c. Time elapse meter; and
- d. Motor ON/OFF light.

Normally, the blower is operated in AUTO mode that enables the blower to be automatically controlled from the control panel. The blower MANUAL operation is used only during testing. A time elapse meter is typically used to indicate blower operation duration and help establish the blower maintenance period. The following are electrical controls included on the flare control panel:

- a. MANUAL/AUTO/OFF selector switch;
- b. Temperature controller;
- c. Pilot ON/OFF light;
- d. Temperature recorder;
- e. LFG ON/OFF light;
- f. Auxiliary fuel ON/OFF light; and
- g. Flame failure light.

Normally, the flare is operated in AUTO mode and requires an operator to push the start button to initiate flare ignition and blower operation.

4.12. Automation of Controls. A good instrumentation and control system design will assure that the individual components of the LFG collection and control system are coordinated and operate effectively. This paragraph will present:

- a. Control elements;
- b. Degree of automation; and
- c. Special instrumentation requirements.

4.12.1. Control Elements. At a minimum, the following process control components are required to ensure safe and proper operation of the LFG collection and treatment system:

- a. Automatic flare temperature controls;
- b. Automatic pilot ignition confirmation interlocked with blower operation;

- c. Flare and blower operation interlocks;
- d. Automated fail-safe valve to isolate piping on power outage;
- e. Pressure and flow indicators for each well;
- f. Blower motor thermal overload protection;
- g. Vacuum relief valve or vacuum switch to effect blower shutdown;
- h. Pressure indicators at blower inlet and outlet; and
- i. High-level switch/alarm for condensate collection system.

A typical piping and instrumentation diagram (P&ID) is shown in Figure 4.2.

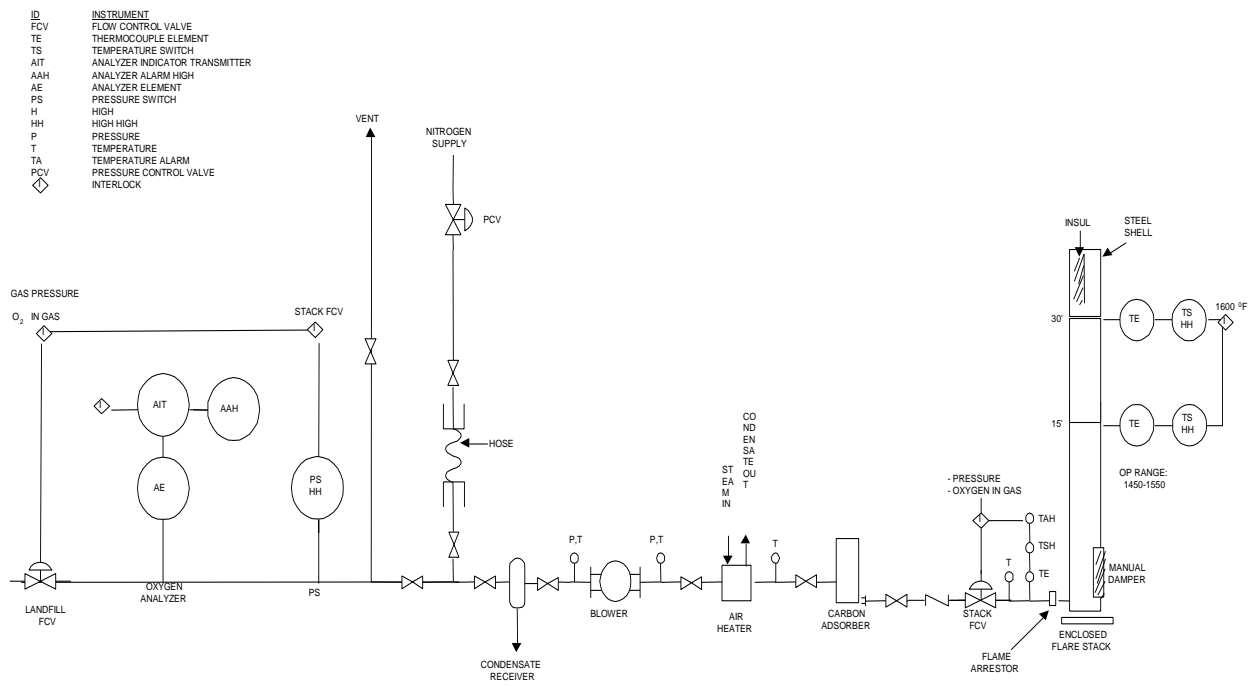

Figure 4.2. Typical Piping and Instrumentation Diagram (P&ID) for a Blower/Enclosed Flare Station.

4.12.1.1. Gas Pressure Gauges. Vacuum/pressure gauges in the operating range of the gas management system are readily available commercially. Several types are available. The only design consideration beyond the vacuum/pressure range is corrosion resistance to the compounds present in the landfill.

4.12.1.2. Methane Gas Detectors. Gas detectors may be placed in the feed manifold system of active collection systems or used as ambient air monitors inside of equipment enclosures to monitor the explosive range (or BTU content) of the recovered gas. Systems that burn the gas have different operating target values than systems that vent or otherwise dispose of the gas. Methane concentration data can be used to adjust LFG extraction and processing conditions. Infrared

instruments that measure methane gas concentration in the manifold system may also be used. Methane presence creates an explosive atmosphere at concentrations ranging between 5% and 15% by volume. The design of any structures that contain LFG equipment should include provisions to maintain concentrations below this range. Proper monitoring and alarm instrumentation should be provided to detect methane concentrations within this range and initiate necessary operating and alarm conditions. Ambient gas monitoring and alarm systems should be interlocked either with a ventilation system and/or emergency shutdown of the entire LFG collection and treatment system in the event an explosive atmosphere is detected.

4.12.1.3. Alarms. The gas control system will usually require several alarms to ensure safe and efficient operation. Alarms must be provided to ensure the condensate collection system does not overflow into the blower train. Alarms are also required to alert for too rich or too lean a feed stream for combustion systems. Some blowers and vacuum pumps require alarms for overpressure or excessive vacuum in parts of the piping system. The system may also contain flow rate alarms to indicate too much or too little gas movement.

Some degree of alarm/shutdown protection is provided in the electrical system that serves the blowers or pumps in the form of thermal overload systems, circuit breakers, or fuses. Alarm shutdown conditions can include the following:

- a. High temperature shutdown;
- b. High-high oxygen alarm (oxygen concentration greater than 4% by volume);
- c. Low-low methane alarm (methane concentration less than 30% by volume);
- d. Flame (no flame detected by main flame thermocouple) or blower fault;
- e. Main power loss; and
- f. Emergency stop or safety valve fault.

4.12.1.4. Control Panel Layout. Scale drawings of the control panel should be prepared for all electrical components and associated wiring. Depending on the project, control drawings may be submitted as a shop drawing by the instrumentation and control contractor.

4.12.1.5. Ladder Logic Diagram. A ladder logic diagram should be included if the process control logic is not apparent from the P&ID. This diagram shows the logical relationships between control components. For example, the diagram may show that if a particular switch is placed in the "on position" and there are no alarm conditions, then the blower will turn on and activate a green indicator light. Another example is when the alarm switch is placed in the on position, signaling that if the

LFG is too rich, then the blower will be turned off to prevent explosive conditions in the flare.

4.12.2. Degree of Automation. The degree of automation is generally dependent on the complexity of the LFG treatment system, the remoteness of the site, as well as monitoring and control requirements. Typically, there is a trade-off between the initial capital cost of instrumentation and control equipment, and the labor cost savings in system operation.

4.12.2.1. Systems designed for unattended operation would incorporate the greatest degree of automation of system controls. Control schemes may include the use of remotely located PLC, remote data acquisition, and modems and radio telemetry (with programmable auto-dialer feature to allow for automated contacting of system operators in the event of alarm or shutdown conditions). System mechanical and electrical components would be selected on the basis of having optimum reliability, while requiring minimum maintenance and adjustment.

4.12.2.2. There are three forms of process control: local, centralized, and remote. In a local control system, the control elements (i.e., indicators, switches, relays, motor starters, etc.) are located adjacent to the associated equipment. In a centralized control system, the control elements are mounted in a single location. These systems may include a hard-wired control panel, a programmable logic controller (PLC), or a computer. Remote control can be accomplished several ways, including the use of modems or radio telemetry. To select the appropriate control scheme, the advantages and disadvantages of each control scheme must be considered. A localized control system is less complex, less expensive, and easier to construct. Centralized control systems are easier to operate. Automated process control is a complex topic that is beyond the scope of this document; however, several points are worth considering. Often, plant operators will be more familiar with traditional hard-wired control logic than with control logic contained in software. However, process logic contained in software is easier to change (once the operator learns the software) than hard wiring, and also allows for system trouble-shooting and restarts or changes in operating parameters from a remote location to reduce the need for site visits.

4.12.3. Special Instrumentation Requirements. Additional information on instrumentation requirements can be found on the USEPA's Technology Transfer Network (TTN). The Technology Transfer Network is a collection of technical websites containing information about many areas of air pollution science, technology, regulation, measurement, and prevention. The USEPA's Emission Measurement Center (EMC) website provides access to emission test methods and testing information for the development and enforcement of national, state, and local emission prevention and control programs. Both USEPA data centers can be found at <http://www.epa.gov/ttn/emc/>.

4.12.4. Variable Frequency Drive Motors. Where practical, design consideration should be given to the inclusion of variable frequency drive (VFD) motors for the various blowers, pumps, etc. included as part of the LFG collection system. VFDs allow for alterations in the pumping/airflow rates by changing the operating speed of the motors as opposed to use of a throttling valve. Use of VFDs for throttling purposes offers the benefits of reducing the power demand and the wear and tear of the motor at reduced flow rates. Use of VFDs is highly recommended for the blower motors, since it is anticipated that the operating flow rate will be reduced as the LFG generation decreases over time, which will in turn reduce the power demand over time and represents a green and sustainable practice. VFDs can be programmed and adjusted through a PLC as part of an automated operating system, which would even allow for adjusting equipment operation remotely.

4.13. Other Design Considerations.

4.13.1. Site Working Areas. Areas should be designated on the site plan for temporary storage. Access to the landfill should be provided to check pipe headers, wellheads, condensate traps, and sumps.

4.13.2. Utilities. Large landfills need electricity, water, communication, and sanitary services. Remote sites may have to extend existing service or use acceptable substitutes. Portable chemical toilets can be used to avoid the high cost of extending sewer lines; potable water may be trucked in; and an electric generator may be used instead of having power lines run into the site. Grounding and lightning protection (for metal structures and equipment) and electrical power feed/controls specifications should be prepared in accordance with NEC and manufacturer requirements by a qualified electrical engineer and installed by a licensed electrician.

4.13.3. Emergency Power. Many LFG extraction systems are equipped with emergency power sources, such as generators, to keep the blowers operating continuously. The control system design should provide for the emergency generators to automatically turn on if the normal power supply fails and to return to normal operation when power is restored.

4.13.4. Water. Water is sometimes required for cooling and sanitary use. A water supply may also be required for fire protection of buildings and or equipment.

4.13.5. Fencing. At some sites, it is desirable to construct perimeter fences to keep out trespassers and animals. If vandalism and trespassing are to be discouraged, a 1.8-m (6-foot) high chain link fence topped by three strands of

barbed wire is desirable. A wood fence or a hedge may be used to screen site operations from public view.

4.13.6. Lighting. If the landfill has structures (employee facilities, administrative office, equipment repair, or storage sheds, etc.), interior lighting requirements need to be determined. Permanent security lighting may also be desirable in some situations. Refer to EM 385-1-1, "Safety and Health Requirements" (Section 7) for lighting requirements.

4.13.7. Labor Requirements. LFG recovery systems typically do not require extensive labor commitments. A regular operation and maintenance (O&M) schedule should be implemented to ensure the proper and uninterrupted operation of the system. Depending on the LFG control system installed and the size of the facility, one full-time operator may be needed to operate and maintain the gas collection system during the day. An automatic control system is capable of operating and controlling the system for shorter unattended periods (e.g., nights and weekends). Flare stations are often left unattended. For unattended operation, a SCADA computer monitoring and control system with remote telemetry should be incorporated into the flare design to shut down the LFG collection system and notify operators via an auto-dialer in case of malfunction.

4.13.8. System Safety. Due to the explosive nature of LFG, flare station electrical equipment and fixtures should typically be classified in accordance with 29 CFR 1910 Subpart S or the NEC as Class 1, Division 2, Group D, or whichever is more stringent. Some local codes may be more restrictive than the aforementioned and should be reviewed as part of the design process.

CHAPTER 5

Operation and Maintenance for Landfill Gas Collection and Treatment Systems

5.1. Introduction. An operation and maintenance (O&M) plan for a landfill gas collection system should be prepared that addresses the following:

- a. Extraction wells;
- b. LFG monitoring probes;
- c. Condensate collection and treatment; and
- d. Flare station.

A site-specific monitoring program should be established that is flexible and performance based. LFG needs to be monitored on a regular basis to enable adjustments to be made to the wells to maximize extraction, prevent migration, and minimize drawing oxygen into the landfill. The procedures need to be regularly evaluated as changing climatic and operational conditions can have an effect on the results obtained. More detailed information on the O&M of LFG collection systems can be found in the reference entitled "Landfill Gas Operation and Maintenance Manual of Practice (SWAMA, 1998)".

5.2. Extraction Wells.

5.2.1. Composition of Air. Knowledge of the composition of air can be used as an aid in monitoring and adjusting the flows from LFG extraction wells. The following provides a typical composition of air:

Nitrogen (N₂) 78.084%
Oxygen (O₂) 20.947%
Argon (Ar) 0.934%
Carbon dioxide (CO₂) 0.033%
Neon (Ne) 18.2 parts per million (ppm)
Helium (He) 5.2 ppm
Krypton (Kr) 1.1 ppm
Sulfur dioxide (SO₂) 1.0 ppm
Methane (CH₄) 2.0 ppm
Hydrogen (H₂) 0.5 ppm
Nitrous oxide (N₂O) 0.5 ppm
Xenon (Xe) 0.09 ppm
Ozone (O₃) 0.07 ppm
Nitrogen dioxide (NO₂) 0.02 ppm
Iodine (I₂) 0.01 ppm
Carbon monoxide (CO) trace
Ammonia (NH₃) trace

As can be seen above, nitrogen, oxygen, argon, and carbon dioxide are the predominant components (99.998%) of air. The ratio of nitrogen to oxygen is 3.8:1. The ratio of total air to oxygen is 4.8:1. This knowledge can be used to estimate the amount of air intrusion through the cover or to check for leakage into the collection piping.

5.2.2. Monitoring. Balancing a LFG extraction well system is best accomplished by monitoring the well field regularly. Each well should be monitored at least monthly for LFG composition, vacuum, flow, and temperature. The monitoring should be more frequent if the LFG is used as fuel in an energy recovery project. LFG composition measurements may include percentages of methane, carbon dioxide, oxygen, nitrogen, and other constituent gases. If excessive vacuum is applied to a LFG well, ambient air intrusion through the cap or well seals will occur. This phenomenon is called over-pull. Over-pull kills anaerobic bacteria and may increase the chance for an underground fire. The best way to monitor for ambient air intrusion at extraction wells is to check the concentration of nitrogen. Any amount of nitrogen in a well is a sign of ambient air intrusion. Unfortunately, monitoring for nitrogen requires analysis by a gas chromatograph, which is time consuming and expensive. The presence of oxygen is also an indicator of ambient air intrusion; however, oxygen is stripped away as it travels through the refuse by bacteria. Therefore, the concentration of oxygen measured at the wellhead is typically reduced, and is not an exact measure of ambient air intrusion.

5.2.3. Balancing Techniques. Techniques for balancing LFG flow rate for a group of extraction wells include the following:

5.2.3.1. Valve Position. Valve position gives a very rough indication of flow rate assuming similar air permeabilities throughout the landfill (or a correlation of valve position versus flow rate for individual wells has been developed).

5.2.3.2. Wellhead Vacuum. Wellhead vacuum can provide a very rough estimate of radius of influence and flow rate if a pilot study or historical data has provided a correlation between wellhead vacuum and flow/radius of influence.

5.2.3.3. LFG Flow Rate. LFG flow rate is often measured using a fixed device such as a pitot tube, orifice plate, or by some portable measurement device such as an anemometer. The required flow rate at each well and for the system as a whole is generally determined empirically based on LFG composition readings.

5.2.3.4. LFG Composition. Methane, nitrogen, and oxygen are the key parameters measured. Carbon dioxide is often measured in order to indirectly determine nitrogen content, since nitrogen is difficult to measure. Carbon monoxide can be monitored as an indicator of a landfill fire (carbon monoxide is generated if the LFG temperature begins to rise).

5.2.3.5. Summary. The best way to balance a LFG extraction system is by monitoring some or all of the parameters listed above at each individual well, plotting trends over several monitoring events, and reviewing the trends to pick the individual well settings that meets the goals of the extraction system.

5.2.4. Primary Well Field Monitoring. Primary wells are those wells located within the landfill boundaries. The frequency of LFG well field monitoring will vary depending upon field requirements and conditions. Normal monitoring frequency for a complete field monitoring session will vary from once a week to once a month. Well field monitoring should not normally need to be extended beyond once a month for active systems.

5.2.5. Perimeter LFG Migration Control. Perimeter collection wells are located at the edge of the landfill to prevent the off-site migration of LFG. Perimeter systems extract poor quality LFG that is often high in oxygen due to ambient air intrusion at the interface of the landfill and native soil. Operating objectives for the perimeter system are different than the primary wells of a LFG extraction system. The perimeter system provides a final opportunity to capture LFG before it migrates beyond the boundaries of the landfill. The frequency of monitoring is based on the perceived threat to the public from the off-site migration of LFG. Some perimeter migration systems are monitored daily if perimeter LFG monitoring probe readings are above established limits. In other cases, the perimeter system is monitored at the same frequency as the rest of the extraction system. Exceedences of compliance levels for % methane or % lower explosive limit (LEL) at the monitoring probes would likely dictate the need to increase extraction flow rates around the areas of the measured exceedences. Chronic exceedences after increasing extraction flow rates may dictate the need to re-evaluate the well design layout and possibly install additional extraction wells at closer spacings.

5.2.6. Barometric Pressure. The amount of LFG migrating beyond the boundaries of a landfill changes as atmospheric pressure varies, even when the LFG production rate is constant. Methane concentrations and LFG pressure measurements in a monitoring probe may be influenced by changes in barometric pressure. There may be a delay of several hours before equilibrium occurs, and this should be taken into consideration when assessing the collected data.

5.2.7. Leachate Blockage of Extraction Wells. Leachate blockage of LFG extraction wells is occasionally a problem. Leachate in the well is either the result of a high water table or perched liquid that is migrating along a low permeable daily cover soil or a low permeability waste and draining into the well. Once liquid is in the well, it usually drains out slower than it drains in, creating a high leachate level in the well. The following procedure for clearing wells blocked with leachate is suggested (Michels, 1998):

- a. Discontinue LFG extraction.
- b. Remove the leachate using a temporary down-hole pump or a vacuum truck for wells that are less than 6.096 m (20 feet) deep.
- c. If leachate continues to flow into the well, or it takes more than five days to remove the liquid, then a permanent method of leachate collection is probably required.

Permanent dual LFG/leachate extraction systems typically include the following:

- a. One well casing for LFG extraction and leachate extraction;
- b. LFG extraction wellhead installed at the top of the well casing;
- c. Pneumatic or electric pump installed in the well casing (pneumatic pumps are most common due to the explosive environment); and
- d. Discharge piping headers.

Discharge of the LFG and leachate from the well is typically combined into one header. However, if the LFG and leachate are combined in one header, typically the header is a larger diameter than if it were simply transporting LFG. In addition, condensate dropouts or low points in a combined header system must be enlarged to allow for the added liquids.

5.2.8. Landfill Fires. Spontaneous combustion is the process by which the temperature of a material is increased without drawing heat from an outside source. In landfills, the process occurs when the waste is heated by chemical oxidation via aerobic biological decomposition to the point of ignition. Landfill fires are most easily controlled by limiting ambient air intrusion into the landfill, which will serve to minimize aerobic biological activity that generates heat and elevates the landfill temperature. Atmospheric air is 21% oxygen and 79% nitrogen. LFG composition typically is measured with a portable LFG analyzer. Instrument readings include percent methane, carbon dioxide, and oxygen. The balance is assumed to be nitrogen. The nitrogen-to-oxygen ratio for atmospheric air is 79/21, which equates to a ratio of 3.76. LFG extraction wells are monitored in order to evaluate system performance. If the oxygen content reaches 3.2% or the nitrogen content is 12% ($3.2 \times 3.76 = 12\%$), ambient air intrusion may be occurring that can create conditions conducive to initiating a landfill fire. If the following is noted during the monitoring of extraction wells, it should be a signal to technicians that conditions are potentially favorable for a landfill fire to occur and increased monitoring or corrective action should be taken:

- a. Oxygen content is increasing and exceeds 3.2 percent by volume.
- b. Nitrogen content is increasing and exceeds 12 percent.
- c. LFG temperature is increasing and exceeds 60°C (140°F).

The following parameters are evidence of a fire within the landfill interior:

- a. LFG temperature exceeds 75°C (167°F).
- b. Rapid settlement of the cover system.
- c. Carbon monoxide levels are greater than 1,000 ppm.
- d. Combustion residue is present in the LFG piping runs.

Landfill fires can be prevented by:

- a. Decreasing the extraction rate at individual wells, which will in turn decrease ambient air intrusion.
- b. Preventing ambient air intrusion by decreasing the air permeability of the landfill cover.
- c. Increasing the monitoring frequency of the extraction wells and probes.

If an interior landfill fire occurs, fire control may be accomplished through the injection of nitrogen or carbon dioxide into the landfill subsurface to suffocate the fire. Extraction of LFG should also be discontinued to prevent oxygen from being drawn into the landfill (Israel, 2000).

5.2.9. Vertical Profiling. A perimeter LFG extraction well will typically penetrate several geologic layers, with each layer exhibiting different properties. LFG will flow to the well through the path of least resistance (usually through the coarser soils). Vertical profiling within the extraction well can be used to determine what geologic strata methane or other gases are traveling through. The profiling involves using a probe to take continuous LFG samples and measuring its velocity at all levels throughout the length of the well. The results may help provide a better picture of where additional extraction wells should be screened to minimize off-site migration of LFG.

5.2.10. Inspection and Maintenance. Inspection and maintenance should be performed during each sampling event. Each LFG extraction well and monitoring probe should be inspected for damage. Any damage should be noted on the field sampling record and repaired. Piping and associated equipment should be inspected for damage and settlement. Piping runs may develop low spots due to differential settlement. Additional drains or drip legs will need to be installed at these low spots if settlement occurs. Piping needs to be checked for leaks and degradation due to UV exposure. Plastic pipes manufactured without UV resistance may need periodic painting/coating to prevent cracking due to UV degradation.

5.3. LFG Monitoring Probes.

5.3.1. Monitoring Procedures. The reference entitled "Landfill Gas Operation and Maintenance Manual of Practice (SWANA, 1998)" provides excellent

information on sampling LFG perimeter monitoring probes and interpretation of the collected data. Monitoring probes are typically placed outside the waste mass at the property boundary or the point of regulatory compliance. LFG monitoring probes are typically tested for the following parameters:

5.3.1.1. Probe LFG Pressure. The vacuum/pressure should be recorded by connecting the pressure gauge to the quick connect valve.

5.3.1.2. LFG Concentrations. Purge the probe of two volumes of LFG and then collect vapor samples for measurements using the appropriate instrumentation and record the appropriate concentrations (methane, carbon dioxide, oxygen, nitrogen, hydrogen sulfide, etc.).

5.3.1.3. Groundwater Level. This should be recorded, if applicable.

5.3.1.4. Summary. The technicians name, date, time, ambient temperature, weather conditions, barometric pressure, and probe number are also typically recorded in a field report form during a sampling event. As mentioned previously, LFG is a mixture of various potential vapor phase constituents, including non-methane organic compounds (NMOCs). Periodic monitoring of specific NMOCs may be required to verify no off-site migration.

5.3.2. In-probe Acceptable Levels. In-probe methane levels should be monitored with an infrared LFG analyzer. A methane concentration greater than 5% by volume in a monitoring probe indicates the potential for explosive conditions. Adjustments to the LFG collection system operating procedures should be made if methane levels exceed some specified level (typically 0.5% to 5%) at the perimeter of the landfill or in structures such as vaults, manholes, sumps, or buildings.

5.3.3. Monitoring Frequency. The frequency at which probes are monitored is typically once per week to once per quarter. However, when LFG concentrations exceed acceptable levels, probes should be monitored at an increased frequency (as frequently as once per day). If monitoring probe readings indicate LFG is migrating off-site, consideration should be given to monitoring off-site structures to ensure LFG is not building up in these structures. Examples of structures that should be monitored include basements, crawl spaces, wells, sumps, subsurface vaults, and any other enclosed location where LFG could potentially collect.

5.3.4. Enclosed Structure Monitoring. LFG monitoring must be conducted in any on-site enclosed structures located on top of or adjacent to the landfill. Enclosed areas that contain a potential sparking device (wiring, electrical motor, etc.) should also be monitored routinely. Buildings are typically monitored at least quarterly with a portable LFG instrument at the following locations:

- a. The base of each exterior wall;
- b. Underground utility lines leading into the building; and
- c. Ambient air in each room of the building.

A continuous monitoring device with alarm should be installed in structures that are frequently occupied. Remedial actions (e.g., venting or increasing LFG extraction rate) should be taken if methane concentrations exceed 25% of the LEL (i.e., 1.25% methane by volume).

5.3.5. Surface Emission Monitoring. Surface emission monitoring is typically performed at large municipal solid waste (MSW) landfills that do not have a geosynthetic barrier in the landfill cover. Surface emission monitoring is not commonly performed on USACE projects, because the waste typically found in military landfills does not produce large amounts of LFG. A summary of surface emission testing procedures can be found in the reference entitled "Landfill LFG Operation and Maintenance Manual of Practice (SWANA, 1998)".

5.4. LFG Monitoring Equipment. Common portable measuring instruments for pressure include micromanometers and magnehelic gauges. A combustible gas indicator (CGI) can be used in above-grade monitoring situations when there is sufficient oxygen for the instrument to operate correctly. Below-grade monitoring, as well as situations where oxygen has been displaced by LFG, require use of an infrared gas analyzer. Several specific instruments are common to LFG control systems that should be considered during design. These include:

- a. CGI;
- b. PID;
- c. Infrared gas analyzers;
- d. Colorimetric tubes; and
- e. Field GCs.

Portable field GCs can be used for on-site monitoring. However, this is an expensive option, because laboratory facilities and trained chemists are required for monitoring operations. CGIs operate on two different principles, catalytic oxidation and thermal conductivity. Some CGIs operate by both methods; however, surface emission sampling will focus on the catalytic oxidation method, as the thermal conductivity detection method is used primarily for LFG measurements in migration probes. The catalytic oxidation type of CGI measures the concentration of a combustible gas in air, indicating the results in parts ppm or in % LEL. These readings are often taken in conjunction with oxygen readings. These instruments operate by the detection method of a platinum filament being heated by the combustion of the LFG being sampled. The increase in heat changes the resistance of the filament that results in an imbalance of the resistor circuit called the

"Wheatstone Bridge". This imbalance is measured via the analog or digital scale of the unit. Some CGIs have two scales, one measuring in ppm and the other in % LEL. Limitations to this equipment are as follows:

- a. The reaction is temperature dependent and is, therefore, only as accurate as the incremental difference between calibration and ambient sampling temperatures.
- b. Sensitivity is a function of the physical and chemical properties of the calibration LFG; therefore, methane should be used as the calibration standard.
- c. The unit will not work in oxygen deficient or oxygen enriched atmospheres.
- d. Certain compounds such as lead, halogens, and sulfur compounds can damage the filament. Silicone will destroy the platinum filament. Since LFG contains some halogenated (chlorinated) hydrocarbons, the meter should be calibrated often to methane and serviced annually if it used on a routine basis to monitor methane surface emissions. In addition, if the meter contains an oxygen cell, this cell can be fouled by the carbon dioxide found in LFG, and replacement of the cell may be required frequently.

Advantages are that CGIs are small and portable, self-contained for field use, have an internal battery, are easy to use, and typically are intrinsically safe.

5.4.1. Combustible Gas Indicator/Thermal Conductivity Method.

5.4.1.1. High concentrations of methane (greater than 100% of the LEL or 5% methane by volume) are measured with a CGI using a thermal conductivity (TC) sensor. This type of sensor is often used with a catalytic oxidation sensor in the same instrument. The catalytic sensor is used to detect concentrations less than 100% of the LEL. At higher concentrations, the TC sensor is used to measure up to 100% methane by volume. The TC sensor is composed of two separate filaments heated to the same temperature. Combustible gases enter only the TC side of the filament; the other filament (compensating) maintains a steady heated temperature. Incoming gases cool the TC filament, and as the filament temperature decreases, the resistance across the Wheatstone Bridge also decreases, resulting in a meter reading. Instruments using a TC sensor do not require oxygen for a valid reading, as burning of the LFG is not involved.

5.4.1.2. Combustible gases vary in their ability to cool the TC filament. Methane absorbs heat well and efficiently cools the filament, and is the calibration gas of choice when using the instrument to measure methane in LFG. However, since LFG is comprised of a combination of different constituents, readings on the meter will vary depending on the concentration of the various constituents in the sample. Gases which cool the filament more effectively than methane (as the calibration gas) will display a higher percent gas reading than is actually present.

5.4.1.3. The converse is also true, that gases which are less effective in cooling the filament will display a lower percent gas reading than is actually present. It is important to realize that certain gases can cool the filament and not be combustible. Carbon dioxide absorbs heat readily and can produce a false positive reading. Meter sensitivity to carbon dioxide varies from manufacturer to manufacturer, so one should be very familiar with the technical information supplied with the equipment. With some meters, calibration with a methane/carbon dioxide mixture can help alleviate the interference of carbon dioxide.

5.4.1.4. There must be sufficient oxygen present in the atmosphere being analyzed for a CGI to work correctly. Therefore, the CGI is a poor instrument selection for monitoring explosive conditions (methane concentrations) directly, since oxygen levels can be very low.

5.4.2. Flame Ionization Detector (FID)/Organic Vapor Analyzer (OVA).

5.4.2.1. FIDs measure many organic gases and vapors, and unlike PIDs will detect methane. Some FIDs are commonly referred to as OVAs. FIDs operate by a sample being ionized in a detection chamber by a hydrogen flame. A current is produced in proportion to the number of carbon atoms present. There are two modes of operation, the survey mode and the GC mode. For methane surface emissions, the survey mode is used if both are available on the instrument. Since the sensitivity of the instrument depends on the compound, methane should be used as the calibration standard. These instruments are less rugged in the field than the CGIs and require hydrogen gas cylinders for use.

5.4.2.2. The advantages to the FIDs are fast response in the survey mode, wide sensitivity (1 to 100,000 ppm), and some models offer a telescopic probe with cup intake that minimizes operator exposure to LFG and minimizes the effects of windy conditions at the site. The "cup" probe design can also serve to reduce the near surface dilution effects of the wind by providing a small sampling chamber when the probe is held normal to the surface. The zero on the FID should be checked daily, since it often drifts upward during use.

5.4.3. Infra-Red (IR) Analyzer.

5.4.3.1. Infrared is a range of frequencies within the electromagnetic spectrum. The infrared frequencies act to set the molecules of chemicals into vibration. Chemicals have a vibration energy that is specific to that chemical. When the gas interacts with IR radiation, it absorbs a portion of the IR energy. The absorption spectrum for that gas is the pattern of vibrations from the atoms/functional groups, along with the overall molecular configuration. Specific gases will demonstrate optimal absorption within a small IR range. Since absorption ranges have been classified for different gases, it is possible to filter out all but a

small part of the spectrum and measure the vapor constituent known to be present. The advantage of IR analyzers is that the high carbon dioxide levels found in landfills will not affect methane readings.

5.4.3.2. Most IR analyzers are single beam spectrophotometers. Portable IR meters available for the field are capable of measuring up to 100% by volume methane and carbon dioxide. The concentrations of these gases are detected by infrared absorption. Oxygen concentration is measured by an electrochemical cell. These meters are designed to measure large concentrations of methane and carbon dioxide and are not sensitive at concentrations less than 0.5%. A field calibration gas should be used to verify the accuracy of the monitoring results. A combination gas of 15% methane and 15% carbon dioxide is a common mixture when using the equipment to test migration probes. Higher concentrations of calibration gases should be used if monitoring levels in LFG extraction wells.

5.4.4. Colorimetric Indicator Tubes. If necessary for regulatory or health and safety purposes, specific NMOCs can be measured in the field using colorimetric tubes that are calibrated for specific chemicals or family of chemicals. Alternatively, samples can be collected for laboratory analysis using Summa canisters for off-site laboratory analysis of specific organic constituents. Colorimetric tubes are typically used as a screening tool only for measuring ambient air concentrations for health and safety or other purposes, since the accuracy of their concentration readings can have an error rate as great as 25% and are subject to various interferences. Colorimetric tubes are capable of measuring air concentrations within a specified range, so some knowledge of the anticipated constituent concentration is needed to select an appropriate tube for use. Previous measurements using field screening instrumentation (e.g., PID) can sometimes be used to estimate the expected concentration. If unknown, then colorimetric tubes representing different concentration ranges should be used for the initial measurements.

5.4.4.1. Various manufacturers exist for colorimetric tubes that offer different chemical and concentration range capabilities. Each manufacturer has its own hand sampling pump that must be used with its brand of colorimetric tubes. It is beneficial to review each manufacturer's line of colorimetric tubes to identify the one(s) that best fit the measurement needs (i.e., chemical specificity and concentration range). Sampling pumps that match the selected colorimetric tube can either be rented or purchased, depending on the frequency of need. The instructions for each colorimetric tube should be carefully reviewed before use to identify the proper number of sample pulls, calibration of tube reading to actual concentrations, other chemicals that can interfere with or skew the measurements, and other use requirements.

5.4.4.2. To perform a measurement using colorimetric tubes, an LFG sample from the piping line must first be collected (if consistent measurements cannot be

obtained directly from the line). The easiest method for collecting a LFG sample is to use a portable vacuum pump to draw a LFG sample from the piping line into a Tedlar bag. The vacuum capacity of the sample pump must be greater than the line vacuum to pull a sample that is not diluted by ambient air (all connections must also be tightly sealed). A short tubing connection can then be used between the Tedlar bag and colorimetric tube to make a tight seal that will allow the hand drawn sample to be drawn through the tube. The change in indicator color allows the measurement to be read off the tube and then converted to the actual concentration measurement in accordance with the instructions.

5.5. Condensate Collection and Treatment. Disposal of LFG condensate is an issue common to most landfill sites in humid climates. Methods of disposal for LFG condensate include the following.

5.5.1. Treatment. LFG condensate can be collected from the various condensate collection points and treated prior to release. When a liner system is present, condensate is commonly combined with landfill leachate and disposed of in the same manner as the leachate.

5.5.2. Injection/Recirculation. Federal solid waste regulations allow leachate and condensate recirculation if the landfill has a composite liner system. Recirculation employs the absorptive properties of the MSW to hold the condensate within the material. However, once the MSW reaches field capacity or decomposes, condensate recirculation in that portion of the site is no longer effective and will short-circuit directly into the leachate collection system. Condensate injection/recirculation is being practiced at numerous sites, and is accomplished primarily through drainage into the collection well field at moisture traps.

5.5.3. Aspiration into the LFG Flare. This method of condensate disposal consists of spraying it directly into a LFG enclosed flare. This technology can typically destroy up to one gallon per minute of condensate. The popularity of this method of disposal is increasing. Aspiration of condensate into LFG flares has been accomplished on several sites and appears to be an efficient and effective method of condensate disposal, provided the condensate is non-hazardous. Flare destruction efficiency is dependent on the following: flare temperature, flare residence time, and turbulence. Tests must be conducted to ensure that condensate aspiration will not cause an unsatisfactory drop in operating temperature of the flare. Analysis of LFG condensate quality, pre-aspiration flare emissions quality, and emission quality during aspiration are typically required. Condensate is transferred from a liquid state to vapor upon aspiration into the flare. This requires approximately 12,000 BTUs of energy per gallon of condensate. With the aspiration of condensate into the flare unit, draft velocities are created during condensate evaporation that could significantly change the retention time on which the original flare design was based. Recent applications of condensate aspiration, however, have not caused a decrease

in destruction efficiencies. Only enclosed flame flares provide adequate residence time for condensate aspiration. Collected condensate is typically collected either for on-site treatment or off-site disposal at a POTW or commercial disposal facility.

5.5.4. Summary.

5.5.4.1. Data that have been published shows that the aqueous phase concentrations of LFG condensate are generally below the Resource Conservation and Recovery Act (RCRA) Toxic Compound Leachate Procedure (TCLP) criteria, which should allow for disposal as a non-hazardous waste. If a non-aqueous phase liquid is present in the condensate, this fraction has been found to typically exceed the RCRA characteristic ignitability criteria, which would require disposal as a hazardous waste. Landfills that have been operating principally as MSW landfills are rarely found to have a significant non-aqueous phase fraction in its condensate.

5.5.4.2. In preparing the proper management plan for condensate, it should first be determined if the condensate contains two phases. If the condensate does have a non-aqueous phase, management plans should include a phase-separation process to separate the non-aqueous phase liquids from the aqueous phase fraction.

5.6. Flare Station. Maintenance and inspection of a blower/flare station is commonly performed on a weekly basis. Activities include LFG flow rate alteration, mechanical repair, lubrication, pilot/auxiliary fuel refill, and equipment cleaning. The total blower LFG flow rate at the station may need to be adjusted due to changes in the flow rate or to eliminate off-site migration. Partially opening or closing the valve on the blower inlet side usually accomplishes flow rate adjustments. The following paragraphs describe additional monitoring requirements associated with various components of a blower/flare system.

5.6.1. Blower.

5.6.1.1. Monitoring Requirements. Inspection of this unit should include recording the flow rate and pressure of the system for comparison against the manufacturer's blower curve. The pressure drop across the blower should also be monitored using permanent gauges or portable magnehelic gages at entrance and exit ports on the blower.

5.6.1.2. Frequency. Monthly inspections should be made, unless recommended otherwise by the manufacturer, to ensure that operating parameters are within expected ranges. After the first year and every second year thereafter (at a minimum), comprehensive inspections by a representative of the manufacturer should be made to determine if parts are wearing at an excessive rate. Should the

equipment warranties recommend more frequent inspection, this frequency should be upgraded to the recommended levels.

5.6.2. Flame Arrestor.

5.6.2.1. Monitoring Requirements. Monitoring of the flame arrestor consists of measuring the head loss across the flame arrestor to ensure that operating head losses are not significantly above or below the losses expected for the unit. In general, flame arrestors require little maintenance (cleaning) and are rarely replaced in operating systems.

5.6.2.2. Frequency. Inspection of the flame arrestor can be infrequent since it does not have any moving parts. Monthly inspections conducted with several other portions of the LFG collection and flaring system will be adequate.

5.6.3. Flare.

5.6.3.1. Monitoring Requirements. The flare unit should be capable of operating at >98 percent destruction requirement efficiency (DRE) for methane. In addition to DRE monitoring, the flare inlet should be inspected for:

- a. LFG flow rates;
- b. LFG supply pressure;
- c. Minimum operating temperatures; and
- d. Influent LFG parameters (including methane, carbon dioxide, oxygen, and regulated NMOCs).

5.6.3.1.1. Manufacturer's recommendations for minimum and maximum values for these parameters should be determined for the specific flare unit. Manufacturers typically specify a minimum supply pressure for a given flow rate. Inspection should include referencing operating parameters of flow rate and pressure drop against the design curve established for the flare. Inspection should verify that a sufficient delivery pressure is being supplied for the observed flow rate.

5.6.3.1.2. The temperature of the flare unit should be monitored to ensure that this parameter is being maintained. The methane content and flow rate of the influent LFG should be inspected as described below. Excessive operating temperatures should not occur, since the flare unit should be designed with automatically adjusting air intake louvers. However, if excessive temperatures (i.e., > 980 °C [1,800 °F]) are observed, controls for these louvers should be inspected.

5.6.3.1.3. LFG parameters. Methane, oxygen, and carbon dioxide levels should be recorded to verify that the operating concentrations are within acceptable ranges for the flare.

5.6.3.2. Frequency. Monthly monitoring is recommended unless suggested otherwise by the manufacturer. Certain operating parameters, including LFG flow rates, LFG supply pressure, minimum operating temperature, and inflow LFG parameters should be measured and recorded more regularly.

5.7. Maintenance Requirements. The O&M of a LFG management system should be structured to maintain the operation goals (e.g., 98% reduction of NMOCs). An O&M program can be divided into the following categories:

- a. Routine O&M;
- b. Non-routine maintenance; and
- c. Emergency services.

5.7.1. Routine Maintenance. A routine maintenance program includes periodic maintenance and preventive maintenance. During routine maintenance, testing and checking of the following components should be performed:

- a. Extraction wells;
- b. Collection header;
- c. Monitoring wells and probes;
- d. Oil change for blower;
- e. Flame arrestor cleaning;
- f. Condensate handling;
- g. LFG detection system;
- h. Pilot/auxiliary fuel; and
- i. Periodic leak testing or screening using field instrumentation (e.g., FID) of major valves and equipment for LFG losses.

5.7.1.1. Pilot/auxiliary fuel refilling and equipment cleaning should be performed at least weekly. In particular, the combustion mechanism requires regular cleaning to assure that the gases are burned completely. Air and oil filters should be checked and changed routinely after a specific number of hours as recommended by the manufacturer. This will prevent more costly and time-consuming repairs down the line. Preventive maintenance includes blower bearing lubrication and flame sensor cleaning.

5.7.1.2. Regular oil changes should also be performed on the blower (positive displacement blowers), compressor, gearbox, and combustion systems. This will

help ensure that the process operates smoothly and efficiently, and it also reduces the chance of costly downtime associated with more significant repairs.

5.7.2. Non-Routine Maintenance. Non-routine maintenance activities consist of corrective repair or maintenance of work identified during the routine inspection. These may include:

- a. Repair or replacement of failing components; and
- b. Testing and adjusting the collection system if air intrusion is observed.

5.7.3. Emergency Services. Emergency services are those requiring immediate response to prevent human injury, property damage, or regulatory non-compliance. These activities may include:

- a. Responding to system failure or shut down; and
- b. Executing contingency plans, if required.

5.7.4. Equipment Calibration. The instruments used for measurements are customarily correct to within a certain percentage of the “true” value. This accuracy is generally expressed by the instrument’s manufacturer as the “inherent error of the device”. Instrument calibration does not lead to elimination of error; it does allow the equipment to provide representative numbers for the subject measurement to the best of the machinery’s ability. Routine calibration and servicing are necessary to assure the quality of measurements made using these instruments. Permanently installed equipment used for measurements should be calibrated according to the manufacturer’s recommendations and the quality assurance program.

5.7.5. System Adjustments Based on Monitoring Data. Landfill operators have to adopt a variety of monitoring parameters, techniques, and frequencies to balance the vacuum system to optimize the volume of collected LFG and/or contain the LFG in all parts of the landfill. For example, the LFG flow rate at the station may need to be reduced due to landfill aging and corresponding reductions in LFG generation. Throttling the control valve on the blower inlet side or at individual extraction wells usually accomplishes the necessary adjustments to reduce total system LFG extraction rate.

5.8. Record-Keeping and Contingency Plan. All inspection and maintenance records must be saved and kept at a location that is easily accessible. If measured methane levels at the compliance points are in excess of regulatory levels or the flare emissions are out of compliance, then the facility must report the results to the appropriate regulatory agency and take steps to correct the situation. An increased frequency of monitoring should then be made until the situation is corrected.

CHAPTER 6 Regulatory Requirements

6.1. Introduction.

6.1.1. This chapter discusses environmental regulations as they pertain to landfill gas (LFG) emissions. Regulations addressed in this section include Resource Conservation and Recovery Act (RCRA) solid and hazardous waste management requirements, Clean Air Act (CAA) requirements, and Clean Water Act (CWA) requirements associated with LFG generation and emissions. Many of the regulations discussed below apply to currently operating or recently closed landfills, and may not be appropriate for landfills that stopped receiving wastes prior to 1987. It is important that personnel know the federal and state regulatory framework under which the LFG control is being done (e.g., general non-hazardous solid waste/refuse disposal, CERCLA remediation, RCRA Corrective Action, etc.) in order to determine which, if any, of the following requirements must be met.

6.1.2. The discussion of applicable regulations and legal requirements in this chapter is only meant to make the reader aware of some of the many requirements that may potentially apply to LFG emissions and disposal of condensate. This chapter is not intended to stand in place of any applicable law, regulation, or standard, and may not reflect the current standards embodied in law and regulation. Statutes and regulations are the controlling rule of law and should always be consulted to determine how they apply to a particular set of circumstances to assure compliance before action is taken. USACE will comply with all applicable laws and regulations. The PM district will provide general legal services in support of FUDS and FUSRAP. For FUDS and FUSRAP projects, the determination of the laws and regulations governing environmental aspects for any specific project will be made in consultation with the Office of Counsel. In the event of any dispute with a regulator over the governing laws on a FUDS or FUSRAP project, the District providing general legal services will represent the agency in negotiations or adversary proceedings. For other work performed by USACE under a different program or authority (i.e., BRAC, IRP, Work for Others), the appropriate legal representative of the sponsoring agency will be the lead counsel for all legal matters, although the USACE Office of Counsel will be available for consultation.

6.2. Summary of Applicable Regulations. Regulations affecting LFG management are addressed under various legislation, which may include the following:

- a. RCRA, which regulates solid and hazardous waste management, such as the landfill itself;
- b. CAA, which regulates air emissions; and

c. CWA, which regulates discharges of water such as LFG condensate and storm water runoff. A brief summary of potential federal regulations applicable to LFG management follows.

6.3. Resource Conservation and Recovery Act Regulations. Under RCRA, if LFG is emitted or condensate is treated and/or disposed, RCRA requirements may have to be met. Primary RCRA requirements pertaining to LFG emission and condensate disposal are found in the following regulations:

40 CFR Part 258 [regulations for LFG emissions from MSW (non-hazardous) landfills];

40 CFR Parts 260-261 [regulations for characterization and disposal of condensate as a hazardous waste];

40 CFR Part 262 [regulations pertaining to hazardous waste generator requirements]; and

40 CFR Part 268 [regulations for hazardous waste land disposal restrictions].

6.3.1. Response actions taken under CERCLA (IRP, FUDS, BRAC or Superfund) are not required to obtain RCRA permits for on-site treatment or storage. However, compliance with substantive requirements, such as physical storage requirements and containers, will most likely have to be met.

6.4. Clean Air Act Regulations. Since passage of the Federal CAA in 1970, many rules and regulations have been adopted that could potentially affect LFG operations. The applicability of these rules and regulations are governed by specific factors, such as the implementation schedule of the rule, size of the facility, the equipment and type of operations conducted at the site, and the emissions from these operations. For example, to establish whether the CAA New Source Performance Standards (NSPS) or Engineering Guideline (EG) controls are applicable to a specific landfill, the non-methane organic compound (NMOC) maximum annual emissions must be greater than or equal to 50 million grams per year (Mg/yr). If the maximum annual NMOC emission rate is greater than or equal to 50 Mg/yr and the design capacity and applicability cut-off dates are triggered, the landfill may be subject to the NSPS or EG. Personnel need to be familiar with the specific requirements of each regulation prior to deciding whether or not the requirements apply to their project. Potentially applicable CAA regulations include:

40 CFR Part 60 [NSPS];

40 CFR Part 63 [National Emission Standards for Hazardous Air Pollutants (NESHAPs)];

40 CFR Part 70 [Title V operating permits]; and state and local air quality regulations.

6.4.1. USEPA designed the Title V operating permit program as a central mechanism to regulate emissions, monitoring data needs, compliance schedules, fee payments, and other conditions associated with the issuance, compliance, and enforcement of operating permits. Personnel involved in designing LFG control systems should ensure that the customer is made aware of calculated LFG emissions and what control devices will be used to control them. This information is important to the customer who is ultimately responsible for determining the need to obtain a Title V operating permit or to revise an existing permit. Any questions regarding the need to obtain an operating permit for the LFG control system should be discussed with the customer and the project team.

6.4.2. Response actions taken under CERCLA (IRP, FUDS, BRAC or Superfund) are not required to obtain CAA permits for on-site emissions and treatment systems. However, compliance with substantive requirements, such as the attainment of emission criteria and use and design of specific treatment technologies, will most likely have to be met.

6.5. Clean Water Act Regulations. Under the CWA, if LFG condensate is disposed of by treatment and effluent discharged to regulated “waters of the United States”, a National Pollution Discharge Elimination System (NPDES) discharge permit is required. Separate NPDES regulatory and permit requirements may also cover storm water run-off associated with a landfill. An NPDES permit would most likely include effluent concentrations/limits that must be met based on a state's water quality standards for the receiving surface water body into which the effluent is being discharged. Effluent analyses that may be required as part of an NPDES permit could include:

- a. Biochemical oxygen demand (BOD);
- b. Chemical oxygen demand (COD);
- c. Total organic carbon (TOC);
- d. Total suspended solids (TSS);
- e. Ammonia (as nitrogen);
- f. Temperature;
- g. pH; and
- h. Flow.

6.5.1. Response actions taken under CERCLA (IRP, FUDS, BRAC, or Superfund) are not required to obtain NPDES discharge permits. However, substantive requirements, such as numerical discharge limits, may still have to be established and met at these sites, especially when condensate is discharged via a point source to regulated “waters of the United States”.

6.5.2. Other analyses may be required if other pollutants are expected to be present. Permittees may also be required to test their discharge for toxicity. If the condensate is disposed of by indirect discharge through a publicly owned treatment works (POTW), sewer effluent conditions would be imposed by the local jurisdiction as regulated by local ordinances or federal requirements.

6.6. State and Local Requirements. Many states and local authorities have also adopted rules that impact LFG emissions and disposal of condensate. The CAA, RCRA, and CWA all contain provisions that generally subject federal facilities to state and local requirements, both substantive and procedural, controlling the same subject matter as the respective federal laws. The appropriate Office of Counsel must be coordinated with to determine whether state and local requirements are applicable to federal activities for a given circumstance. States can, and frequently do, have regulations that are more stringent than the federal requirements. It is crucial that personnel know the specific requirements of the state in which the project is located, and whether those requirements apply in a specific circumstance, in order to ensure compliance with applicable regulations.

APPENDIX A
References

A.1. Required Publications.

A.1.1. Government Publications.

A.1.1.1. Army.

ER 200-1-5

Policy for Implementation and Integrated Application of U.S. Army Corps of Engineers Environmental Operating Principles and Doctrine

EM 200-1-17

Monitoring Well Design, Installation, and Documentation at HTRW Sites

EM 200-1-18

Soil Vapor Extraction and Bioventing

EM 1110-1-1802

Geotechnical Exploration for Engineering and Environmental Investigations

EM 1110-1-1804

Geotechnical Investigations

EM 1110-1-4008

Liquid Process Piping

DG 1110-1-3

Air Stripping

A.1.1.2. United States Environmental Protection Agency (USEPA).

AP-42, 5th Edition, Volume I, Chapter 2: Solid Waste Disposal
Compilation of Air Pollutant Emission Factors/Emission Factor Documentation for
Municipal Waste Landfills, Chapter 2., EPA Office of Air Quality Planning and
Standards, Research Triangle Park, NC. <http://www.epa.gov/ttnchie1/ap42>

EPA/600/2-86/073

Critical Review and Summary of Leachate and Gas Production from Landfills, March
1987, EPA ORD, Cincinnati, OH. <http://www.epa.gov/epahome/publications.htm>
<http://www.epa.gov/ttn/chie/ap42/ch02/final/c02s04.pdf>

EM 200-1-22

30 Apr 13

EPA/600/SR-92/037

Development of an Empirical Model of Methane Emissions from Landfills, April 1992, EPA Office of Air Quality Planning and Standards, Research Triangle Park, NC.

<http://www.epa.gov/epahome/publications.htm>

EPA/453/R-96/004

Municipal Solid Waste Landfills: Summary of Requirements for the New Source Performance Standards and Emission Guidelines for Municipal Solid Waste Landfills, Volume I, 1999a, EPA Office of Air Quality Planning and Standards, Research Triangle Park, NC. <http://www.epa.gov/epahome/publications.htm>

EPA/625/R-96/010b

Compendium of Methods for the Determination of Toxic Organic Compounds in Ambient Air: 2nd Edition, January 1999b, EPA ORD, Washington, DC.

<http://www.epa.gov/epahome/publications.htm>

EPA/600/R-05/123a

Guidance for Evaluating Landfill Gas Emissions from Closed Landfills or Abandoned Facilities, September 2005a, EPA Office of Air Quality Planning and Standards, Research Triangle Park, NC. <http://www.epa.gov/epahome/publications.htm>

EPA/600/R-05/047

Landfill Gas Emissions Model (LandGem) Version 3.02 User's Guide, May 2005b, EPA Office of Air Quality Planning and Standards, Research Triangle Park, NC.

<http://www.epa.gov/ttn/chief/efpac/esttools.html>

EPA/625/R-96/010b

Compendium of Methods for the Determination of Toxic Organic Compounds in Ambient Air: 2nd Edition, EPA ORD, Washington, DC., January 1997.

<http://www.epa.gov/epahome/publications.htm>

OSWER Number 9200.081

Superfund Landfill Methane-to-Energy Pilot Project, December 2010, EPA OSRTI, Washington, DC. <http://www.epa.gov/epahome/publications.htm>

A.1.2. Non-government Publications.

American Conference of Industrial Hygienists (ACGIH)

Industrial Ventilation: A Manual of Recommended Practice, 25th Edition, Publication #2094. <http://www.acgih.org/home.htm>

ASTM STP 1070

Landva, A.O. and Clark, J.I., Geotechnics of Waste Fill – Theory and Practice, 1990.

ASTM D 6497

Mechanical Attachment of Geomembrane to Penetrations or Structures, American Society of Testing and Materials, Philadelphia, PA.

Bagchi (1990)

Bagchi, A., Design, Construction, and Monitoring of Sanitary Landfills, John Wiley, New York, 1990.

British Columbia Ministry of Environment (BCME; 2010)

Conestoga-Rovers and Associates, "Landfill Gas Management Facilities Design Guidelines", Prepared for the British Columbia Ministry of Environment, March, 2010. www.env.gov.bc.ca/epd/mun-waste/guidelines.htm

Brown and Clister (1993)

Brown, K.S., and Clister, W.E., "Design Procedures for Landfill Gas Interception, Collection, and Extraction Systems Pursuant to the Proposed EPA Regulations for the Control of Landfill Gas". National Waste Management Association Waste Tech 93, Marina del Ray, California, January 1993.

CES-Landtec (1993)

"Landfill Gas System Engineering Design" seminar courseware, CES – Landtec.

Dudek et. al. (2010)

Dudek, J. and Klimek, P. et. al., "Landfill Gas Energy Technologies", Oil and Gas Institute of Krakow, Developed under EPA Assistance Agreement XA-83449001-1, 2010.

Emcon Associates (1980)

Emcon Associates, Methane Generation and Recovery from Landfills, Ann Arbor Science Publishers, Inc., Ann Arbor, MI, 1980.

Farquhar (1989)

Farquhar, G.J., "Factors Influencing Landfill Gas Recovery", University of Wisconsin Sanitary Landfill Leachate and Gas Management Seminar, Madison, WI, December 4-7, 1989.

Ham (1989)

Ham, R.K., "Landfill Gas Generation: Compositions, Quantities, Field Test Procedures and Uncertainty", University of Wisconsin Sanitary Landfill Leachate and Gas Management Seminar, Madison, WI, December 4-7, 1989.

Ham and Barlaz (1987)

Ham, R.K. and Barlaz, M.A., "Measurement and Prediction of Landfill Gas Quality and Quantity", ISWA International Symposium, Process, Technology, and

EM 200-1-22

30 Apr 13

Environmental Impact of Sanitary Landfills, Cagliari, Sardinia, Italy, October 20-23, 1987.

Israel (2000)

Israel, T.S., "Control of a Landfill Fire at a Site Closed with A Synthetic Cover", Proceedings from the 23rd Annual landfill Gas Symposium, San Diego, CA, March 27-30, 2000, p. 149.

Michels (1998a)

Michels, M.S., "Landfill Gas Management", Solid Waste Technologies, July/August 1998.

Michels (1998b)

Michels, M.S., "Landfill Gas Management", Solid Waste Technologies, September/October 1998.

NFPA 70 (1999)

National Electrical Code, National Fire Protection Association, 1999.

Solid Waste Association of North America

Landfill Gas Operation and Maintenance – Manual of Practice, Solid Waste Association of North America (SWANA), Silver Springs MD, 1997. www.swana.org

Stecker (1989)

Stecker, P., "Active Landfill Gas Recovery Systems, University of Wisconsin Sanitary Landfill Leachate and Gas Management Seminar", Madison, WI, December 4-7, 1989.

Thiel (1998)

Thiel, R.S., "Design Methodology for a Gas Pressure Relief Layer Below a Geomembrane Landfill Cover to Improve Slope Stability", Geosynthetics International, 5 (6): 589-617, 1998.

Zolten and Saigal (1991)

Zolten, N.G., and Saigal, K.K., "A Primer on Landfill Gas Blower/Flare Stations", Proceedings from the GRCD/SWANA's 14th Annual Landfill Gas Symposium, San Diego, CA, March 26-28, 1991, p. 120.

A.2. Related Publications.

Solid Waste Association of North America

A Compilation of Landfill Gas Field Practices and Procedures (2011) and numerous symposium publications and seminars, Solid Waste Association of North America (SWANA), Silver Springs MD. www.swana.org

EPA LFG to Energy Support Resources
Landfill to Methane Outreach Program (LMOP). <http://www.epa.gov/lmop>

EPA Webinar
Superfund Landfill Methane Potential Assessment (LFG Energy Project Assessment
Tool and LMOP LFG Energy Evaluation of the Fresno Sanitary Landfill).
<http://www.clu-in.org>

EPA (1996)
“Turning a Liability into an Asset: A Landfill Gas to Energy Project Development
Handbook”, September 1996. <http://www.epa.gov/epahome/publications.htm>

Kramer (1994)
Kraemer, T., “Monitoring, Data Analysis, and Adjustment of Landfill Gas Control
System”, SWANNA 17th Annual Landfill Gas Symposium, March 22-24, 1994.

Moody (1944)
Moody L.F., “Friction Factors for Pipe Flow”, Transaction ASME, Vol. 66, 1944.

Peramanki (1993)
Peramanki, M.P., “Soil-Vapor Extraction System Piping Design and Blower
Selection: A Spreadsheet Program”, Proceedings of the National Ground Water
Association, Outdoor Action Conference, May 1993.

Pierce and LaFountain (2000)
Pierce, J.L. and LaFountain, L.J., “Application of Advanced Characterization
Techniques for Identification of Thermogenic and Biogenic Gases”, Proceedings
from the 23rd Annual Landfill Gas Symposium, San Diego, CA, March 27-30, 2000,
p. 153.

Prosser (1985)
Prosser, R.W., “The Effects of Atmospheric Pressure on the Availability of Gas from
a Landfill”, GC Environmental, Inc., 1985.

Prosser (1995)
Prosser, R.W. and Janechek, A., “Landfill Gas and Groundwater Contamination”
GC Environmental, Inc., 1995.

Prosser (1998)
Prosser, R.W., “Reviewing and Interpreting Landfill Gas Monitoring Data”, GC
Environmental, Inc., 1998.

EM 200-1-22

30 Apr 13

Prosser (1999)

Prosser, R.W., "Optimizing Landfill Gas Collection from Arid Landfills", GC Environmental, Inc., 1999.

Prosser (2000)

Prosser, R.W., "NSPS Tier III Alternative Test Procedure", GC Environmental, Inc., 2000.

Sullivan (1992)

Sullivan, W., "Landfill Gas Condensate Collection Using the Vacuum Extraction Method". Proceeding of 15th Annual Landfill Gas Symposium, 1992.

Wilson-Fahmy et al. (1996)

Wilson-Fahmy et al., "Design Methodology for the Puncture Protection of Geomembranes", 1996.

Useful Design Websites:

EPA Landfill Methane Outreach Program: www.epa.gov/lmop

General Engineering Design Information, Equations, Data, and Tools:

www.engineeringtoolbox.com

General Engineering Spreadsheet Calculations:

www.engineeringexceltemplates.com

APPENDIX B

Landfill Gas Collection System Calculations

B.1. General. The following is a hypothetical example that illustrates the calculations used in the design of an LFG collection and treatment system (Emcon Associates 1980).

B.1.1. Site Background Information. The 25-acre Westslope Landfill is located near Omaha, Nebraska and accepted municipal, industrial and construction debris from the neighboring communities from 1970 to 1995. In 1972 the state required a 6-inch daily cover be used to minimize odors. In 1999, the State required that the landfill be closed with a multi-layer cap composed of a 6 inch grading layer, a 40-mil HDPE geomembrane, a geonet drainage layer, and 24 inches of cover soil. The State also required that an active gas control system be installed to limit off-site subsurface migration of landfill gas to 10% of the LEL for methane. A housing development is located adjacent to the landfill on the south side of Center Street. A plan view of the site is shown in Figure B.1.

B.1.2. Site Geology. Bedrock consisting of weathered limestone underlies the site at approximately elevation 980 in the central area of the landfill. The bedrock slopes gently to the east. The overburden soils consist of 20 to 30 feet of silty sand. Ground water fluctuates seasonally at the site and is approximately 15 feet below the original ground surface.

B.1.3. Objective.

- a. Design an active landfill gas collection system that consists of vertical extraction wells to prevent the off-site migration of gas.
- b. Design an enclosed flare to destroy methane and non-methanogenic organic compounds (NMOCs) in the collected gas.

B.2. Site Characteristics.

- a. Landfill footprint = 25 acres
- b. Volume of waste = 1,700,000 cy

B.3. Refuse Characteristics.

- a. Average age of Refuse = 20 to 25 years
- b. In-Place Refuse Density = 1,200 lbs/cy
- c. Capping Material = 40 mil HDPE

d. Maximum Depth = 45 feet

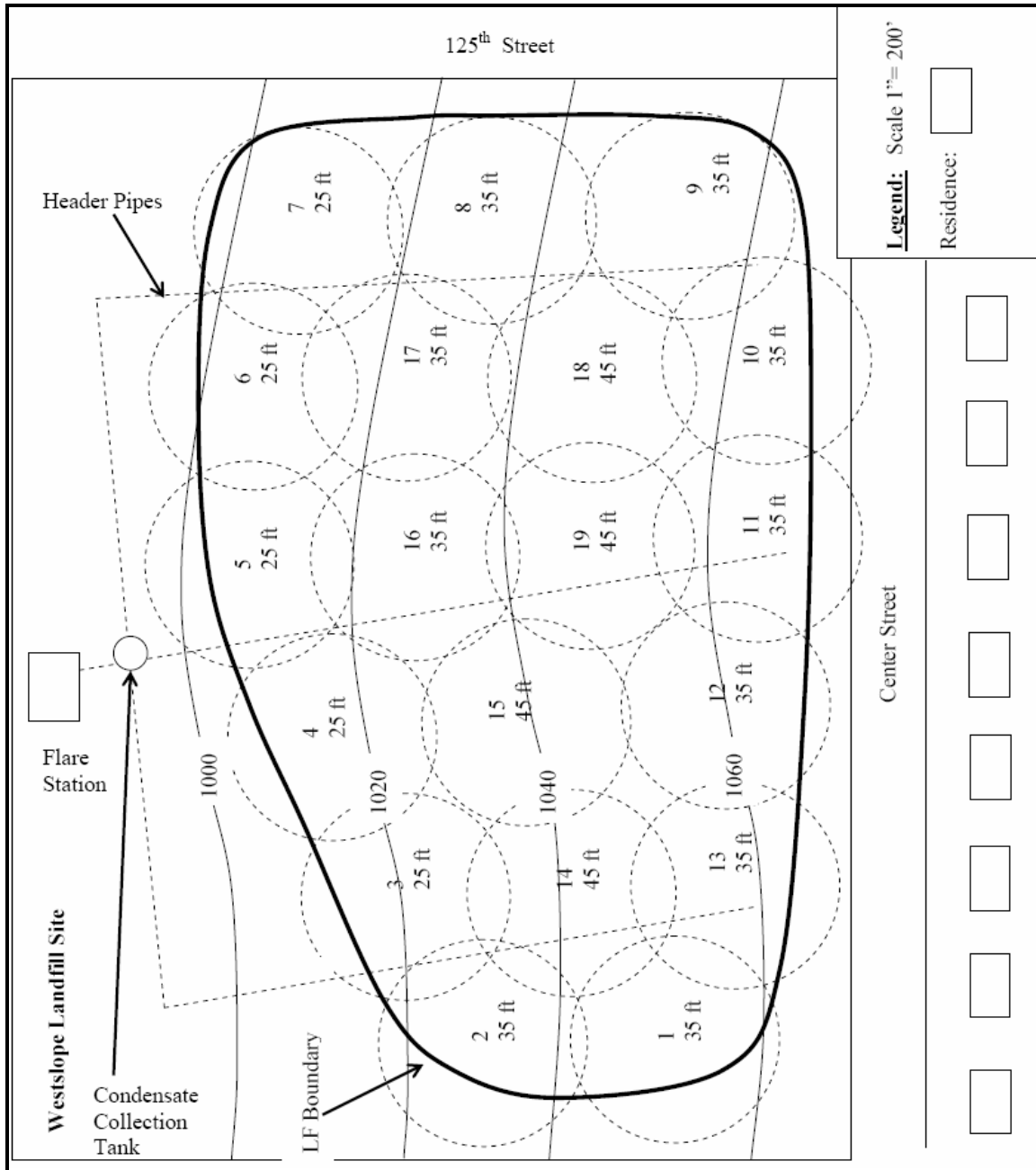

Figure B.1. Plan View of the Site.

B.4. Gas Characteristics.

- a. Landfill gas emission rate = 1.6×10^{-4} ft³/(lb day)
- b. Concentration of methane in gas = 50 percent

- c. Assumed radius of influence of extraction wells = 150 feet
- d. Temperature of landfill gas = 110°F
- e. Landfill Gas Viscosity = 2.58×10^{-7} lb s/ft²

B.5. Calculations for the LFG Collection System.

B.5.1. Sample Problem Design Calculations.

B.5.1.1. General Assumptions.

V = volume of waste (1,700,000 cy)

D = density of waste (45 lb/ft³)

G = methane production rate = 1.6×10^{-4} ft³/(lb day)

B.5.1.2. Flow Rate for Entire Landfill.

$Q_{\text{tot}} = (\text{volume of waste})(D)(G)$

$Q_{\text{tot}} = (1,700,000 \text{ yd}^3)(27\text{ft}^3/\text{yd}^3)(45\text{lb}/\text{ft}^3) [1.6 \times 10^{-4} \text{ ft}^3/(\text{lb day})]$

$Q_{\text{tot}} = 330,480 \text{ ft}^3/\text{day} = 230 \text{ ft}^3/\text{min}$ (methane)

As methane is 50% of the landfill gas produced, the total flow rate of extracted landfill gas is:

$$2 \times 230 \text{ ft}^3/\text{min} = 460 \text{ ft}^3/\text{min}$$

B.5.1.3. Determine Flow Rates from a particular well (Cylinder Method).

$$Q = \pi (R^2 - r^2) t D G$$

where:

Q = methane flow rate

R = radius of influence

r = borehole radius (assumed to be 12 inches for all wells [which is negligible])

t = waste thickness

D = density of waste (45 lb/ft³)

G = methane production rate [1.6×10^{-4} ft³/(lb day)]

B.5.1.3.1. For 25-Foot-Deep Wells.

EM 200-1-22

30 Apr 13

$R = 150$ feet, $t = 25$ feet

$$Q = \pi (150)^2 (25 \text{ ft})(45 \text{ lb/ft}^3)[1.6 \times 10^{-4} \text{ ft}^3/(\text{lb day})] = 12,723 \text{ ft}^3/\text{day}$$

$$Q = 8.84 \text{ ft}^3/\text{min} \text{ (methane only)}$$

Since landfill gas is 50% methane:

$$\text{Landfill gas flow} = 2 \times 8.84 = 17.7 \text{ ft}^3/\text{min}.$$

B.5.1.3.2. For 35-Foot-Deep Wells.

$R = 150$ feet, $t = 35$ feet

$$Q = \pi (150)^2 (35 \text{ ft})(45 \text{ lb/ft}^3)[1.6 \times 10^{-4} \text{ ft}^3/(\text{lb day})] = 17,812 \text{ ft}^3/\text{day}$$

$$Q = 12.4 \text{ ft}^3/\text{min} \text{ (methane only)}$$

$$\text{Landfill gas flow} = 2 \times 12.4 = 24.8 \text{ ft}^3/\text{min}.$$

B.5.1.3.3. For 45-Foot-Deep Wells.

$R = 150$ feet, $t = 45$ feet

$$Q = \pi (150)^2 (45 \text{ ft})(45 \text{ lb/ft}^3)[1.6 \times 10^{-4} \text{ ft}^3/(\text{lb day})] = 22,900 \text{ ft}^3/\text{day}$$

$$Q = 15.9 \text{ ft}^3/\text{min} \text{ (methane only)}$$

$$\text{Landfill gas flow} = 2 \times 15.9 = 31.8 \text{ ft}^3/\text{min}$$

5 wells at 17.6 ft ³ /min	= 88 ft ³ /min
10 wells at 24.8 ft ³ /min	= 248 ft ³ /min
4 wells at 31.8 ft ³ /min	= <u>127 ft³/min</u>
Total	= 463 ft ³ /min

B.5.1.4. Determine Pressure Drop Required at Each Well to Maintain Assumed Radius of Influence.

$$\Delta P = \mu G_{\text{tot}} D [R^2 \ln(R/r) + (r^2/2) - (R^2/2)] / 2 K_s$$

where:

ΔP = pressure difference from the outer edge of the radius of influence to the gas vent

R = radius of influence

r = radius of borehole (assumed to be 12 inches for all wells)

μ = absolute viscosity of the landfill gas ($1.21 \times 10^{-5} \text{ N s/m}^2 = 2.581 \times 10^{-7} \text{ lb s/ft}^2$)

- K_s = apparent permeability of the refuse (assumed to be 15 Darcy = 2.29×10^{-8} in.²)
 D = density of the refuse (45 lb/ft³)
 G_{tot} = total landfill gas production rate (assumed to be $2 \times 1.6 \times 10^{-4}$ ft³/(lb day)).

B.5.1.4.1. For All Wells: M (Melema Factor) = $\mu G_{tot} D / 2 K_s$

$$M = [(2.581 \times 10^{-7} \text{ lb s/ft}^2)(2)[1.6 \times 10^{-4} \text{ ft}^3/(\text{lb day})](45 \text{ lb/ft}^3) (\text{day}/86,400 \text{ s})] / [(2)(2.29 \times 10^{-8} \text{ in.}^2)(1 \text{ ft}^2/144 \text{ in.}^2)]$$

$$M = 1.314 \times 10^{-4} \text{ lb/ft}^4$$

B.5.1.4.2. For All Wells, Assumed Radius of Influence is 150 Feet.

$$\begin{aligned} \Delta P &= M[R^2 \ln(R/r) + (r^2/2) - (R^2/2)] \\ &= 1.314 \times 10^{-4} \text{ lb/ft}^4 [(150\text{ft})^2 \ln(150 \text{ ft}/1 \text{ ft}) + \{(1 \text{ ft})^2/2\} - (150 \text{ ft})^2/2] \\ &= 1.314 \times 10^{-4} \text{ lb/ft}^4 [101,489 \text{ ft}^2] \\ &= 13.33 \text{ lb/ft}^2 \\ &= 2.57 \text{ inches of water column.} \end{aligned}$$

B.5.2. Header Pipe Sizing. Pipe sizing is a tradeoff between the capital cost of the pipe and the energy requirements of the blower. The higher cost of larger pipe must be balanced against lower horsepower requirements of the blower due to less pressure loss due to friction.

- a. Header pipe size = 6 inches
- b. Connector pipes from wells to headers = 2 inches

B.5.3. System Curve. The system curve is determined by computing all head losses through the system at various flow rates due to the following:

- a. Subsurface head loss.
- b. Head loss in pipes.
- c. Head loss through fittings and valves.

The friction losses from the subsurface, the straight pipe lengths, and the valves and fittings are added together to obtain the total friction loss at a given flow rate. Note that these calculations are performed assuming that the valves are fully open.

B.5.3.1. Subsurface Head Loss. Assume 2.57 inches as computed in paragraph B-5.1.

30 Apr 13

B.5.3.2. Calculate Pipe Head-Loss. The most common method of predicting friction losses in straight pipes is to use the Darcy-Weisbach equation:

$$h_f = f(L/d)(v^2/2g)$$

where:

- h_f = head loss, m (ft) of fluid
- f = friction factor for the pipe, dimensionless (dimensionless)
- L = length of segment, m (ft)
- d = inside pipe diameter, m (ft)
- v = average velocity of the flow, m/sec (ft/s)
- g = acceleration due to gravity ($9.81 \text{ m/s}^2 = 32.2 \text{ ft/s}^2$).

The head loss calculated by this formula is in feet of landfill gas. The ideal gas law can be used to estimate the density of the gas passing through the header pipe. Estimate the gas density to convert pressure in feet of landfill gas to inches of water column (in wc).

$$\text{Gas Density} = PM/R_U T$$

where:

- P = absolute pressure within header pipe
Assuming 30 in. wc vacuum
- 1 atm = 407.2 inches of water column (in wc)
- P = $(407.2 \text{ in. wc} - 30 \text{ in. wc}) / 407.2 \text{ in. wc} = 0.926 \text{ atm}$
- M = molecular weight of landfill gas
= $0.5 (\text{molecular weight methane, CH}_4) + 0.5(\text{molecular weight of carbon dioxide, CO}_2)$
= $0.5 (12+4) + 0.5 (12+2 \times 16) = 30 \text{ kg/kg-mole}$
- R_U = Universal gas constant
= $0.0821 \text{ L-atm/g-mole K}$
- T = Absolute Temperature
= $110^\circ\text{F} = 43.3^\circ\text{C} + 273.16^\circ\text{K} = 316.5^\circ\text{K}$.

$$\begin{aligned} \text{Landfill Gas Density} &= PM/R_U T \\ &= [(0.93 \text{ atm}) \times (30 \text{ kg/kg-mole})] / [(0.0821 \text{ L-atm/ g-mole K}) \times (316.3 \text{ K}) \\ &\quad \times (1000 \text{ g-mole/kg-mole})] \\ &= 1.069 \times 10^{-3} \text{ kg/L} \end{aligned}$$

$$\begin{aligned} \text{Landfill Gas Density} &= (0.001069 \text{ kg/L} \times 2.205 \text{ lb/kg} \times 28.32 \text{ L/ft}^3) \\ &= 0.0668 \text{ lb/ft}^3 \end{aligned}$$

1 pound-force/square inch (PSI) = 27.6799048 inch of water [4 °C]

To convert feet of landfill gas to inches of water column, the following factor (F) must be applied:

$$\begin{aligned} F &= 0.0668 \text{ lb/ft}^3 \times 1 \text{ ft}^2/144 \text{ ft}^2/\text{in.}^2 \times 27.7 \text{ in. wc}/(\text{lb}/\text{in.}^2) \\ &= 0.01284 \text{ in. wc}/\text{ft} \end{aligned}$$

$$\text{Head Loss, in. wc} = 0.01284 \times fLV^2/2d \times g = 0.0002 fLV^2/d.$$

B.5.3.3. Head Loss Through Valves and Fittings. There are two primary methods for estimating head losses through valves and fittings.

- a. Look up k values in tables (where $k = fL/d$ and, therefore, $h_f = kV^2/2g$).
- b. Use tabulated values of equivalent length of straight pipe. For example, the resistance in a 6-inch standard tee is equivalent to that of approximately 30 feet of 6-inch straight pipe.

B.5.3.4. Landfill Gas Piping Flow Diagram. The piping system consists of headers that connect to 19 wells in three manifolds (Figure B.2). The manifolds connect to a flare stack through a condensate knockout tank, blower, and flame arrestor.

B.5.3.5. Manifold 1 Calculations. Different flow rates were used for wells installed with different screen lengths: 17.6 scfm for the 25-foot wells, 24.8 scfm for the 35-foot wells, and 31.8 scfm for the 45-foot wells. The wells are connected to a common header. The pressure loss from each well to a common point in the header was calculated to establish the required header vacuum. Following is the example calculation for header # 1. Calculations for headers #2 and #3 are similar.

B.5.3.5.1. Well Number 10. The approximate head loss from well #10 (flow rate of 24.8 scfm) including soil head loss (2.57 in. wc) plus wellhead losses (2.00 in. wc) plus discharge piping losses to header 1 at point b (0.668 in. wc) is 5.238 in. wc vacuum. The following piping head losses are additive to point j:

- 0.005 in. wc vacuum—approximate b–c piping head loss
 - 0.017 in. wc vacuum—approximate c–d piping head loss
 - 0.039 in. wc vacuum—approximate d–e piping head loss
 - 0.062 in. wc vacuum—approximate e–f piping head loss
 - 0.090 in. wc vacuum—approximate f–g piping head loss
 - 0.099 in. wc vacuum—approximate g–h piping head loss
 - 0.132 in. wc vacuum—approximate h–i piping head loss
 - 0.454 in. wc vacuum—approximate i–j piping head loss
- The total head loss from well 10 to point j is 6.136 in. wc.

wc) plus discharge piping losses to header 1 at point g (0.337 in. wc) is 3.914 in. wc vacuum. The following piping head losses are additive to point j:

- 0.0099 in. wc vacuum—approximate g–h piping head loss
 - 0.0132 in. wc vacuum—approximate h–i piping head loss
 - 0.454 in. wc vacuum—approximate i–j piping head loss
- The total head loss from well 7 to point j is 4.39 in. wc.

Table B-1. Piping Head Loss Calculations

Landfill Gas Piping System - Manifold 1

Dimensions of Schedule 40 HDPE Pipe

Nom I. D. Cross-Sectional Area.

in.	in.	in. ²	ft ²
2	2.067	3.356	0.02331
3	3.068	7.393	0.05134
4	4.026	12.730	0.08840
6	6.065	28.890	0.20063
8	7.981	50.030	0.34743
10	10.020	78.850	0.54757

LFG Composition: 50% Methane, 50% Carbon Dioxide

MW LFG : 0.5(16) + 0.5(44) = 30

Density LFG 0.067183 lb/ft³

Temperature LFG 110°F

Absolute Viscosity LFG 2.58×10⁻⁷ lb(force) s/ft²

Absolute Viscosity LFG 8 ×10⁻⁶ lb(mass)/ft s

$Re = Dvp/\mu$

Head Loss, in. wc = (0.0002007)*fL(v²)/D*

Node	Component	Flow	Nom I.D.,ft	X-Sect	Pipe	Ftg	Ftg	Reynolds	Friction	Well	Pipe	Ftg	Total
From	Thru	Rate	I.D.	Vel	L, ft	Loss	Equiv	Number	Factor	h.l.	h.l.	h.l.	h.l.
		CFM	In.	FPS	Coef	ft pipe	Re	<i>f</i>		in wc	in. wc	in. wc	in. wc
a	b	well 10	24.8							2.57			2.570
		well head	24.8	2						2			2.000
		piping	24.8	2	0.1723	17.74	60	2.47×10 ⁴	0.0270		0.5937		0.594
		ball valve	24.8	2									0.000
		2x6	24.8	2								0.0732	0.073
		Tee(branch)	24.8	6	0.5054	2.06	60	30	8.42×10 ³	0.0302		0.0015	0.002
		Sub-Total											5.238
18	d	well 18	31.8							2.57			2.570
		well head	31.8	2						3.288			3.288
		piping	31.8	2	0.1723	22.74	60	3.17×10 ⁴	0.0270		0.9762		0.976
		ball valve	31.8	2								0.00000	0.000
		2X6	31.8	2								0.12051	0.121
		Tee(branch)	31.8	6	0.5054	2.64	60	30.0	1.08×10 ⁴	0.0300		0.00249	0.002
		Sub-Total											6.958
7	g	well 7	17.6							2.57			2.570
		well head	17.6	2						1.007			1.007
		piping	17.6	2	0.1723	12.59	60	1.75×10 ⁴	0.0270		0.2990		0.299
		ball valve	17.6										0.000
		2x6	17.6	2								0.03688	0.037
		Tee(branch)	17.6	6	0.5054	1.46	60	30.0	5.98×10 ³	0.0350		0.00089	0.001
		Sub-Total											3.914

EM 200-1-22
30 Apr 13

Node	Component	Flow	Nom I.D.,ft	X-Sect	Pipe	Ftg	Ftg	Reynolds	Friction	Well	Pipe	Ftg	Total
From	Thru	Rate	I.D.	Vel	L, ft	Loss	Equiv	Number	Factor	h.l.	h.l.	h.l.	h.l.
		CFM	in	FPS		Coef	ft pipe	Re	f	In. wc	In. wc	In. wc	In. wc
b	c	24.8	6	0.5054	2.06	70		8.42×10^3	0.0302		0.0036		0.004
		24.8	6	0.5054	2.06	20	10.0					0.00051	0.001
													0.004
c	d	49.6	6	0.5054	4.12	70		1.68×10^4	0.0276		0.0130		0.013
		49.6	6			20	10.0					0.00372	0.004
													0.017
d	e	81.4	6	0.5054	6.76	70		2.76×10^4	0.0270		0.0343		0.034
		81.4				20	10.0					0.00490	0.005
													0.039
e	f	106.2	6	0.5054	8.82	70		3.61×10^4	0.0251		0.0543		0.054
		106.2				20	10.0					0.00776	0.008
													0.062
f	g	131	6	0.5054	10.88	70		4.45×10^4	0.0240		0.0791		0.079
		131				20	10.0					0.01129	0.011
													0.090
g	h	148.6	6	0.5054	12.35	70		5.05×10^4	0.0230		0.0975		0.097
		148.6				20	10.0					0.00139	0.001
													0.099
h	I	166.2	6	0.5054	13.81	70		5.64×10^4	0.0218		0.1155		0.116
		166.2				20	10.0					0.01650	0.017
													0.132
i	j	166.2	6	0.5054	13.81	30	15.0	5.64×10^4	0.0218			0.02476	0.025
		166.2	6	0.5054	13.81	260		5.64×10^4	0.0218		0.4292		0.429
													0.454

B.5.3.6. Head Losses to the Blower Intake. The total head loss from well #18 to point j exceeds the losses from well #10 and also well #7 to point j (Table B-1 and Figure B.3). Therefore the head loss in well #18 and associated piping determines the required the header vacuum. Control valves at the other wells will have to be throttled to maintain the required flow rates at those wells. The blower vacuum required is equal to the head losses to point j (7.833 in. wc) + point k-l (0.888 in. wc) + the condensate tank (2.00 in. wc) + point m-n (0.335 in. wc) = 11.076 in. wc.

B.5.3.7. Calculations for Combined Flow to the Flare Stack. Refer to the flow sheet (Figure B.4 and Table B-2) for piping from point j through the condensate knock out tank, blower, flame arrestor, and stack. The 12.444 in. wc blower discharge head requirement is the sum of head losses from point o to the stack discharge at ambient atmospheric pressure. The 12.444 in. wc represents the pressure exerted on the discharge side of the blower resulting from the various pieces of equipment attached to the discharge side of the blower.

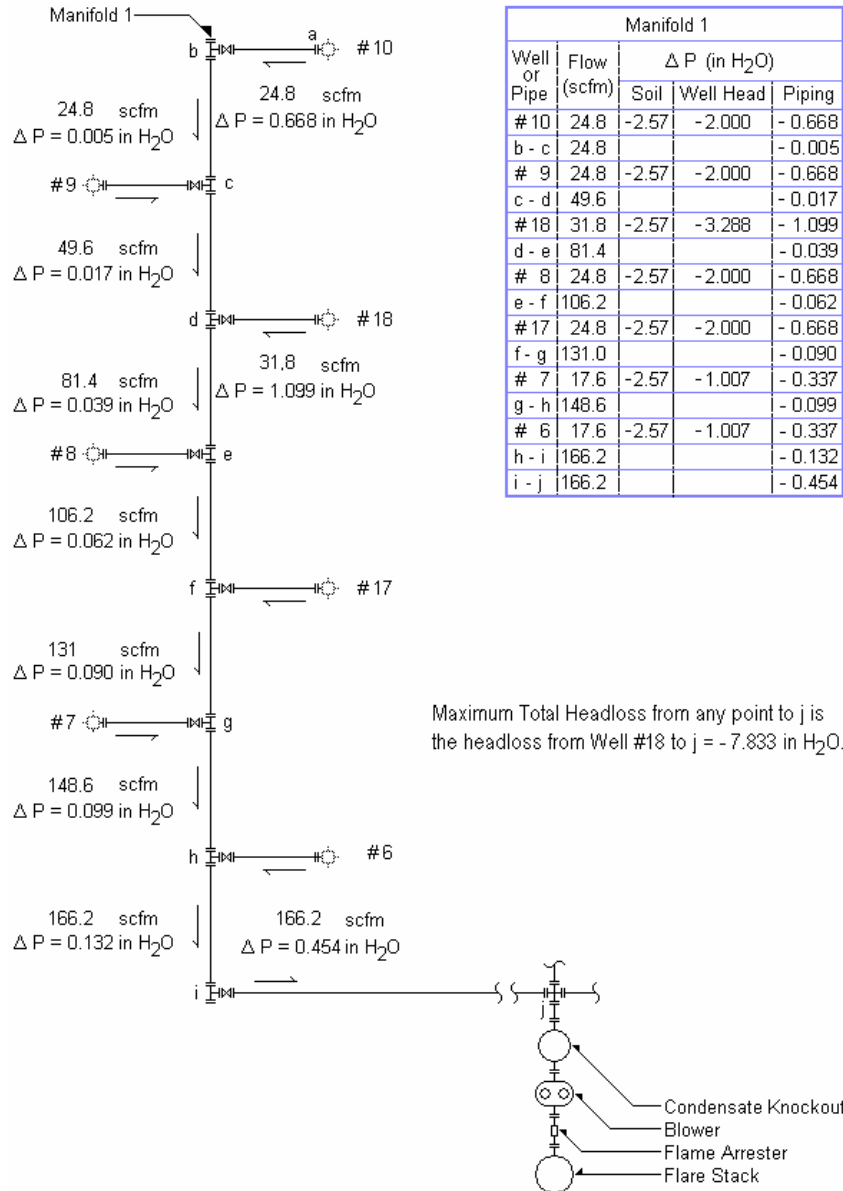

Figure B.3. Piping Head Loss Diagram

B.5.4. Blower Selection Considerations. Three criteria are used to size the blower: flow (463 SCFM), head loss on the suction side of the blower (11.076 in. wc), and discharge head on the outlet side of the blower (12.444 in. wc). Based on these criteria, manufacturer's catalogs are used to select a blower that can meet these criteria. It is important to select a blower that only minimally exceeds the calculated requirements to avoid exceeding the capacity of any of the in-line treatment processes.

It is a difficult task to select a blower that will remain in an efficient operating range over the long-term because gas production varies during the life of the landfill.

EM 200-1-22

30 Apr 13

Consideration should be given to selection of a variable frequency blower motor drive for energy conservation and greater operating flexibility as the generation of landfill gas decreases over time.

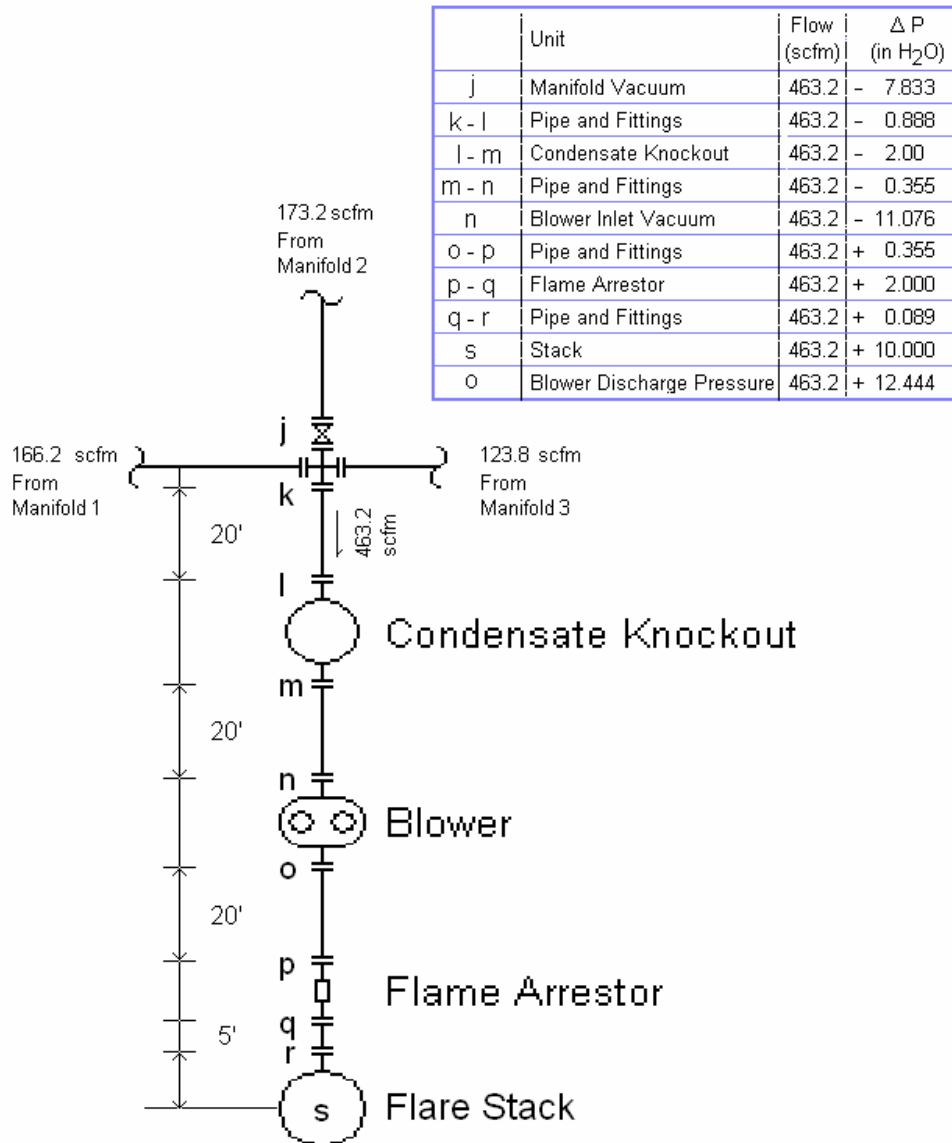

Figure B.4. Discharge Pressure Diagram

Table B-2. Blower Discharge Pressure Calculations

Landfill Gas Piping System - Combined flow to stack

Dimensions of Schedule 40 HDPE Pipe

Nominal I. D. Cross-Sectional Area.

in.	in.	in. ²	ft ²
2	2.067	3.356	0.02331
3	3.068	7.393	0.05134
4	4.026	12.730	0.08840
6	6.065	28.890	0.20063
8	7.981	50.030	0.34743
10	10.020	78.850	0.54757

LFG Composition: 50% Methane, 50% Carbon Dioxide

MW LFG : 0.5(16) + 0.5(44) = 30

Density LFG

0.067183 lb/ft³

Temperature LFG

110 deg F

Absolute Viscosity LFG

2.58×10⁻⁷ lb(force) s/ft²

Absolute Viscosity LFG

8.31×10⁻⁶ lb(mass)/ft s

$Re = Dvp/u$

Head Loss, in. $wc = (0.0002007)fL(v^2)/D$

Node	Component	Flow	Nom I.D.	X-Sect	Pipe	Ftg	Ftg	Reynolds	Friction	Well	Pipe	Ftg	Press
From	Thru	Rate	Dia	Vel	L, ft	Loss	Equiv	Number	Factor	h.l.	h.l.	h.l.	in. wc
		CFM	In.	FPS		Coef	ft pipe	Re	f	in. wc	in. wc	in. wc	in. wc
j	j												-7.833
k	l	piping	463.2	6	0.5054	38.48	20	1.57×10 ⁵	0.0302		0.3552		-0.355
		Tee(Branch)	463.2		0.5054	38.48	60	30.0				0.53271	-0.533
		Sub-Total											-0.888
l	m	condensate tank											-2.000
m	n	piping	463.2	6	0.5054	38.48	20	1.57×10 ⁵	0.0302		0.3554		-0.355
n	n	blower inlet vacuum											-11.076
o	p	piping	463.2	6	0.5054	38.48	20	1.57×10 ⁵	0.0302		0.3554		0.355
p	q	flame arrestor											2.000
q	r	piping	463.2	6	0.5054	38.48	5	1.57×10 ⁵	0.0302		0.0888		0.089
r	s	stack											10.000
n	o	blower discharge pressure											12.444

B.5.5. Condensate Production Rate. Assume air is extracted at 100% relative humidity and remains at 100% relative humidity as it travels from the extraction well to the blower. Determine the amount of condensate removed as a result of the temperature drop of the gas. The gas is assumed to be at its maximum temperature as it exits the well. The gas will drop in temperature as it travels through the header piping. The length of travel, location of the header pipe, and the ambient temperature will determine the magnitude of the temperature drop over the section of header piping for which condensate generation is being computed.

A rough estimate of the amount of condensate generated can be determined using psychrometric charts for air. The following assumptions were made in order to compute the amount of condensate produced.

B.5.5.1. Flow Rate. The flow rate was determined to be 463 ft³/min (218 L/s) in the above calculations.

EM 200-1-22

30 Apr 13

B.5.5.2. Temperature. The temperature of the gas exiting the landfill is 110°F (316.3 K) and drops 20° to 90°F (305 K) as it travels to the blower system.

B.5.5.3. Potential Condensate Generated. Psychrometric charts can be used to estimate saturated water vapor concentration at different temperatures:

Conc. of water vapor = 0.059 kg water/kg landfill gas (at 316.3 K)

Conc. of water vapor = 0.031 kg water/kg landfill gas (at 305 K)

Subtracting:

Potential Condensate = 0.028 kg water/kg landfill gas

Note that most psychrometric charts are created for higher pressures than are typically found in the header pipes of a LFG collection system. However, using these charts will generally not introduce large error when estimating condensate generation.

Density of landfill gas = 1.074×10^{-3} kg/l = .067 lbs/ft³

The flow rate times the concentration of the condensate yields the following condensate generation rate:

$(0.028 \text{ kg water/kg LF gas}) \times (1.074 \times 10^{-3} \text{ kg/L}) \times (218 \text{ L/s}) \times (86,400 \text{ s/day}) \times (1 \text{ L/kg}) = 566 \text{ L/day} = 150 \text{ gal/day}$.

