



Online Continuing Education for Professional Engineers  
Since 2009

# Fall Prevention in Industry

PDH Credits:

**4 PDH**

Course No.:

**FPI101**

Publication Source:

**NC Dept. of Labor**

**"A Guide to Fall Prevention in Industry"**

*N.C. Department of Labor Occupational Safety and Health Division  
Industry Guide 32*

Revised Date:

July 2010

**DISCLAIMER:**

All course materials available on this website are not to be construed as a representation or warranty on the part of Online-PDH, or other persons and/or organizations named herein. All course literature is for reference purposes only, and should not be used as a substitute for competent, professional engineering council. Use or application of any information herein, should be done so at the discretion of a licensed professional engineer in that given field of expertise. Any person(s) making use of this information, herein, does so at their own risk and assumes any and all liabilities arising therefrom.

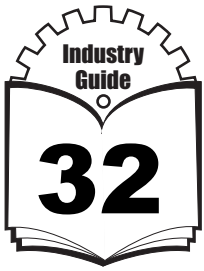

# A Guide to Fall Prevention in Industry



***NCDOL***  
*N.C. Department of Labor*

N.C. Department of Labor  
Occupational Safety and Health Division  
1101 Mail Service Center  
Raleigh, NC 27699-1101

Cherie Berry  
Commissioner of Labor

**N.C. Department of Labor  
Occupational Safety and Health Program**

Cherie Berry  
Commissioner of Labor  
*OSHA State Plan Designee*

Allen McNeely  
Deputy Commissioner for Safety and Health

Kevin Beauregard  
Assistant Deputy Commissioner for Safety and Health

Fleda Anderson  
Reviewer

**Acknowledgments**

This edition of *A Guide to Fall Prevention in Industry* includes material prepared by the Oregon Occupational Safety and Health Division; the U.S. Department of Labor, Occupational Safety and Health Administration; and the L.A. Weaver Company of Raleigh, N.C. Safety standards officer Tom Savage conducted a comprehensive review of this guide. Some changes have been made to reflect the most current North Carolina experience. The information in this guide was updated in 2010.

**This guide is intended to be consistent with all existing OSHA standards; therefore, if an area is considered by the reader to be inconsistent with a standard, then the adopted standard should be followed.**

**To obtain additional copies of this guide, or if you have questions about N.C. occupational safety and health standards or rules, please contact:**

**N.C. Department of Labor  
Education, Training and Technical Assistance Bureau  
1101 Mail Service Center  
Raleigh, NC 27699-1101**

**Phone: 919-807-2875 or 1-800-NC-LABOR**

---

Additional sources of information are listed on the inside back cover of this guide.

---

The projected cost of the NCDOL OSH program for federal fiscal year 2011–2012 is \$17,841,216. Federal funding provides approximately 31 percent (\$5,501,500) of this fund.



# Contents

<b>Part</b>		<b>Page</b>
	Foreword . . . . .	v
1	Trips, Slips and Falls—An Overview . . . . .	1
2	Falls From the Same Level . . . . .	4
3	Stairways and Ladders . . . . .	7
4	Construction Industry Fall Protection Requirements . . . . .	14
5	Digest of General Industry OSHA Standards Regarding Fall Prevention . . . . .	34
6	Digest of Construction Industry OSHA Standards Regarding Fall Prevention . . . . .	37
7	OSHA Requirements for Guardrails, Safety Harnesses, Safety Nets and Other Protection . . . . .	42
	References . . . . .	44

# Foreword

The total dollar cost to victims and families affected by work-related deaths and injuries, to employers, and to the nation as a whole is much greater than the cost of workers' compensation insurance alone. The National Safety Council estimates that the total cost of occupational deaths and injuries in 2005 was \$625.5 billion. That figure includes wage and productivity losses, medical costs, administrative expenses, cost estimates for workers to make up lost work time due to another worker's injury, and the time to investigate and report injuries.

Safety and health in the workplace is everyone's responsibility. Employers must be aware of workplace hazards facing their workers, and they must take appropriate action to minimize or eliminate exposure to these hazards. Workers are responsible for following the policies, procedures and training requirements established by their employers. *A Guide to Fall Prevention in Industry* discusses precautions that can prevent and protect workers against fall injuries and fatalities. There is also a convenient digest listing many fall protection standards in OSHA General Industry and Construction Industry regulations.

In North Carolina, the N.C. Department of Labor enforces the federal Occupational Safety and Health Act through a state plan approved by the U.S. Department of Labor. NCDOL offers many educational programs to the public and produces publications to help inform people about their rights and responsibilities regarding occupational safety and health.

When reading this guide, please remember the mission of the N.C. Department of Labor is greater than just regulatory enforcement. An equally important goal is to help citizens find ways to create safe workplaces. Everyone profits when managers and employees work together for safety. This booklet, like the other educational materials produced by the N.C. Department of Labor, can help

Cherie Berry  
Commissioner of Labor

## Trips, Slips and Falls—An Overview

In 2008, the Bureau of Labor and Statistics (BLS) reported that 680 workers died in fatal falls, a 20 percent decline from the series high of 847 fatal falls in 2007. The number of fatal falls in 2007 had increased by 39 percent since 1992 when the Census of Fatal Occupational Injuries program was first conducted. In 2008, fatal falls to a lower level accounted for 85 percent of falls. The percentage of falls from roofs and ladders decreased in 2008 from 2007. However, the number of fatal falls on the same level (to a floor or walkway or against an object) increased slightly in 2008. According to the BLS National Census of Fatal Occupational Injuries in 2008, “economic factors likely played a role in the fatality decrease. Average hours worked at the national level fell by one percent in 2008, and some industries that have historically accounted for a significant share of worker fatalities, such as construction, experienced larger declines in employment or hours worked.” Included in the statistics were falls from roofs, ladders, scaffolds and falls on the same level. Falls from ladders and roofs still account for the majority of falls. Identifying fall hazards and deciding how best to protect workers is the first step in reducing or eliminating fall hazards.

People have fallen from considerable heights and received only a few broken bones, while others fall to the floor from a standing or sitting position and die from their injuries. Nearly all falls result from conditions or practices that seem obvious; however, preventing such accidents requires maintaining safe conditions in the workplace and training to ensure safe actions by employees.

Listed below are some common problem and solution areas to consider concerning your workplace.



*Tripping*



*Stumbling*

**Problem:** People fall by tripping over some object such as a tool on the floor, stairs or walkways.

**Solution:** To remedy this situation it is necessary that all places where people walk be kept clear of such tripping hazards. Employees must not leave tools or materials in places where they or others can trip over them. Work areas should be designed and arranged to eliminate pipe, conduit, supports, etc., at the floor level. Tools and other equipment should be placed in their proper storage areas when not being used.

**Problem:** People fall by stumbling into holes in the floor or over uneven floors caused by loose boards, cracked concrete, etc.

**Solution:** The obvious remedy for this situation is to keep floors in good condition and to repair defects as they occur. The actual prevention job may require the elimination of the causes of worn floors, such as steel-wheeled carts and handtrucks, excessive vibration of machines, or too heavy loading of the floor for the type of construction.

**Problem:** People fall by slipping on floors, stairs, etc., which are wet from water, oil or chemicals.

**Solution:** If it is unavoidable for the floor to be wet, the flooring should be of non-slip type, or the employees should wear shoes with nonskid soles, or both. If the floors are normally dry, water spillage should be cleaned up immediately. Spilled oil, grease or chemicals should be removed at once and the source of the spill checked and corrected.

<b>Tripping and Stumbling Hazards</b>
<ul style="list-style-type: none"> <li>Objects out of place</li> <li>Objects or materials in walkways</li> <li>Tools on the floor</li> <li>Projecting parts of machines or equipment</li> <li>Equipment or material on stairs</li> <li>Scrap or waste materials</li> <li>Pipe or conduit set near floor level</li> <li>Extension cords, power cables, air hoses, welding cables, fuel, gas and oxygen hoses</li> <li>Uneven floor surface:                             <ul style="list-style-type: none"> <li>Holes and depressions in floor or other walkway</li> <li>Projections—warped or loose boards or blocks</li> <li>Broken floor surface</li> <li>Uneven patches</li> <li>Uncovered drains, pits</li> <li>Bent floor boards or plates</li> <li>Loose or poorly fitted grating</li> <li>Sudden changes in pitch or elevation</li> <li>Sagging or expanded floor supports</li> </ul> </li> </ul>

<b>Slipping Hazards</b>
<ul style="list-style-type: none"> <li>Wet floors, stairs, walkways:                             <ul style="list-style-type: none"> <li>Water</li> <li>Oil or grease</li> <li>Chemicals</li> </ul> </li> <li>Smooth floors, stairs, walkways:                             <ul style="list-style-type: none"> <li>Waxed, polished surface</li> <li>Metal plate or cover</li> <li>Tile, terrazzo, marble</li> </ul> </li> </ul>



*Slipping*

**Problem:** People not seeing where they are stepping. This may be caused by poorly lighted areas; by carrying or pushing loads that are so large as to obstruct the view; or by being distracted and not paying attention to where they are going.

**Solution:** Observation and recognition of these hazards by supervisors or other workers should be reported to the proper authority immediately. Supervisors have the additional special responsibilities with regard to safety in the workplace of encouraging safe work habits and correcting unsafe ones, explaining to the workers all the potential hazards associated with their work areas and being responsive to employee requests for action or information regarding possible hazards in the workplace.



**Problem:** People fall because of faulty stairs or handrails. Narrow, unevenly spaced, broken treads or stairs that are too steep present conditions that are unnatural. Broken, improperly set or lack of handrails can result in falls that could have been prevented.

**Solution:** People learn to walk on standard stairs and get into the habit of stepping a certain distance. Any variation of the stair is liable to cause a misstep. Be sure that fixed industrial stairs are installed: with a minimum width of 22 inches; with angles to the horizontal of between 30 and 50 degrees (See Table D-1); with treads that are reasonably slip resistant; with rise height and tread width that is uniform throughout the flight of stairs; designed and constructed to carry a load at least five times the anticipated weight; with a minimum vertical clearance of 7 feet; and with standard railings provided and installed in accordance with §1910.23 and 1910.24.



**Table D-1**

[Table D-1 is taken from the North Carolina Occupational Safety and Health Standards for General Industry: Standard 1910.24(e).]

Angle to horizontal	Rise (in inches)	Tread run (in inches)
30°35'	6½	11
32°08'	6¾	10¾
33°41'	7	10½
35°16'	7¼	10¼
36°52'	7½	10
38°29'	7¾	9¾
40°08'	8	9½
41°44'	8¼	9¼
43°22'	8½	9
45°00'	8¾	8¾
46°38'	9	8½
48°16'	9¼	8¼
49°54'	9½	8

**Problem:** People fall from high places.

**Solution:** Walkways, tramways, scaffolds and piles are hazardous unless proper safeguards and safe work methods are used. Use the proper personal protective equipment for the situation. Be sure to check over all equipment before use to ensure it is in good condition. Keep all areas clean: no scrap, loose tools or tangled lines. Follow manufacturer's instructions to the letter on all equipment. (For further information concerning falls from elevations, please refer to Part 4.)

**Problem:** People fall because of unsafe ladders. Ladders may be unsafe because of their construction, condition or use.

**Solution:** It is necessary that ladders be inspected carefully at regular periods to detect and correct any structural defects or unsafe conditions, such as sharp edges, splinters or burrs. Training should be provided concerning safety-related work practices relating to ladders, and employees should be required to use the safe practices.

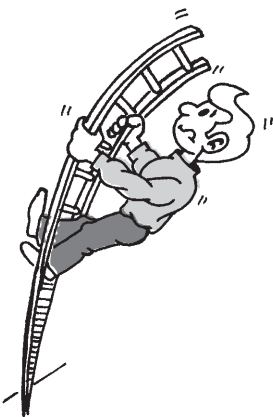

## **Safety Check List**

- 1. Are floors, stairs and walkways clear and free from tools, materials, oil, grease, water or chemicals?
- 2. Are the floors and walkways smooth and free from holes, cracks and loose boards?
- 3. Where the operation requires the floor to be wet frequently, is the floor surface rough-finished concrete or some other nonslip type?
- 4. Are the employees encouraged to wear shoes with nonskid soles in potentially wet or slippery areas?
- 5. Are the walkways and work areas arranged so as to avoid tripping hazards at floor level?
- 6. Are barricades and warning signs used where unavoidable tripping hazards are present?
- 7. Have the workers been trained to replace items, such as tools, immediately after use?
- 8. Are walkways, stairs, ramps and work areas adequately lighted?
- 9. Are the stairs in good condition and provided with handrails?
- 10. Are the risers on stairs of equal height?
- 11. Are the treads of stairs smooth and free from holes, cracks and excess wear?
- 12. Are ladders in good condition, free from cracks, burrs and splinters?
- 13. Are all ladders inspected regularly by a competent person?
- 14. Are all elevated walkways, tramways, catwalks and scaffolds provided with toeboards, handrails, and intermediate railings?



## 2

# Falls From the Same Level

### *Worker/Floor Surface Coupling*

The concept of worker/floor surface coupling relates to the friction between a worker's shoe sole and the working surface. This consideration figures prominently in work-surface related accidents, such as:

- Slips (loss of traction on work surfaces)
- Trips (movement of lower body is arrested)
- Missteps (putting the foot down where there is no support)

These accident patterns account for almost three-quarters of work-surface-related accidents. A prime variable in such accidents is the friction between the working surface and the shoe sole.

### *General Observations About Friction*

There are laws of friction that, generally stated, inform us that on dry surfaces:

- Friction is independent of the area of contact (a brick will require the same force to be pushed or pulled across the floor whether it is flat, on edge or on end).
- The relationship between static and kinetic friction is such that it is harder to get something started from rest than to keep it sliding. In other words, as velocity increases, friction decreases.
- Friction is dependent upon the nature (texture) of the surfaces in contact.

The laws of friction can be used to structure our environment to reduce particular types of falls.

### **Shoe Sole**

Safety shoes with cord or rubber soles are more desirable than leather when working on wet surfaces because of the greater friction between them and the walking surface. Friction between the shoe sole and the working surface is dependent upon:

- Work surface material (wood, concrete, steel, tile and other substances)
- Surface coating (for example, waxes can both increase and decrease friction)
- Floor condition (clean or dirty; wet, dry, icy or greasy)
- Floor angle (greater friction is required for steeper slopes)
- Shoe sole/heel composition and contact area (rubber soles and certain synthetic soles are better than leather under dry conditions, but differences reduce or even reverse under wet conditions)
- Style of shoe (shoes with high or narrow heels are the most hazardous)

There is an optimum relationship regarding friction between the worker's shoes and the working surface. Shoe soles come in a variety of materials and thicknesses. Therefore, select shoes according to the hazards and the type(s) of walking-working surfaces. \*For example, neoprene soles work well on wet or dry surfaces, but not in oily conditions. Crepe is acceptable on concrete, but not on smooth surfaces such as tile and wood. <sup>1</sup>

---

<sup>1</sup>The general recommendation is to adjust shoes and working surfaces to give a coefficient of static friction of 0.5. The coefficient of friction for surfaces (floors) can be calculated by using a pull-gauge and the formula  $\mu = f/N$ , where  $\mu$  = coefficient of friction,  $f$  = force required to pull the object, and  $N$  = normal force between surfaces (for horizontal surface,  $N$  = weight of object).

\*From the Commonwealth of Virginia's Worker's Compensation Program.

## Working Surface

Table 1 lists common materials and the coefficient of friction for each.

**Table 1**

***Materials and Coefficient of Friction***

Oak on oak	0.25
Rubber on concrete	0.70
Metal on oak	0.55
Metal on elm	0.20
Hemp on oak	0.53
Steel on steel	0.18
Greased surfaces	0.05
Iron on concrete	0.30
Leather on metal	0.56
Steel on babbitt	0.14

Unnoticed changes in surface friction are implicated in many accidents. Going from a less slippery floor to a more slippery one produces slips; the opposite change produces trips and missteps. These unnoticed changes can be reduced by:

- Ensuring that different surface materials or coatings have transition zones between them.
- Clearly marking any surface where friction changes (for example, using wet floor signs).
- Using good housekeeping procedures to reduce changes in surface friction caused by spills, worn spots, and loose or irregular floors.

The above recommendations are of particular importance in manual materials handling where any handling other than direct lifting involves horizontal inertial forces transmitted from the container to the body. Such forces require increased frictional forces to prevent foot slippage. Carrying weights also affects the body's learned reflexes for recovering from a slip or trip. In such situations, the body's normal weight distribution is altered and the arms are prevented from being used to regain balance.

Tables 2 and 3 below were taken from the *Accident Prevention Manual for Industrial Operations: Administration and Programs* (and are reprinted with the permission of the National Safety Council). Table 2 reports on characteristics of materials that can be used for working surfaces (floors).

**Table 2**

***Physical Properties of Floor Finishes***

The second, third and fourth columns report resistance to Abrasion [A], Impact [Imp] and Indentation [Ind]. The last four columns report on Slipperiness [S], Warmth [W], Quietness [Q] and Ease of Cleaning [EC].

<b>Types of Finish</b>	<b>A</b>	<b>Imp</b>	<b>Ind</b>	<b>S</b>	<b>W</b>	<b>Q</b>	<b>EC</b>
Portland cement concrete in situ	VG-P*	G-P	VG	G-F	P	P	F
Portland cement concrete precast	VG-G	G-F	VG	G-F	P	P	F
High-alumina cement concrete in situ	VG-P	G-P	VG	G-F	P	P	F
Magnesite	G-F	G-F	G	F	F	F	G
Latex-cement	G-F	G-F	F	G	F	F	G-F
Resin emulsion cement	G-F	G-F	F	G	F	F	G-F
Bitumen emulsion cement	G-F	G-F	F-P	G	F	F	F
Pitch mastic	G-F	G-F	F-P	G-F	F	F	G
Wood block (hardwood)	VG-F	VG-F	F-P	G-F	F	F	G
Mastic asphalt	VG-F	VG-F	VG-F	VG	G	G	G-F
Wood block (softwood)	F-P	F-P	F	VG	G	G	G-P
Metal tiles	VG	VG	VG	F	P	P	G-F
Clay tiles and bricks	VG-G	VG-F	VG	G-F	P	P	VG
Epoxy resin compositions	VG	VG	VG	VG	F	F	VG

\*VG (very good), G (good), F (fair), P (poor)

Table 3 is a guide to the selection of floor materials.

**Table 3**  
**Guide to Floor Materials and Surfaces**

Types*	Characteristics	Use of Abrasives	Dressing Materials
Asphalt tile	Blended asphaltic and/or resinous thermo-plastic binders and/or other inert filler materials and pigments.	May be used to reduce slipperiness of floors. Colloidal silica** can be incorporated in wax and synthetic resin floor coatings.	Wax/wax products: Carnauba wax dries in place with very hard/glossy finish but with a slippery surface. It is widely used as a base for floor surface preparations.
Linoleum	Cork dust, wood floor, or both, held together by binders of linseed oil or resins and gum. Pigments are added for color.		Bees and petroleum waxes are softer and less slippery, depending on the formulation.
Rubber	Vulcanized, natural, synthetic, or combination rubber compound cured to a sufficient density to prevent creeping under heavy foot traffic.	Slip-resistant except when wet.	
Vinyls	Inert, nonflammable, nontoxic resins compounded with other filler and stabilizing ingredients.	Adhesive fabric with ingrained abrasives can be used. Patterned in strips, tiles, and cleats.	
Terrazzo	Marble or granite chips mixed with a cement matrix.	Silicon carbide or aluminum oxide can be included in mix when floor is laid. Also an abrasive-reinforced plastic coating can be painted on.	Slip-resistant sealant will improve slip-resistant quality if renewed periodically.
Concrete	Portland cement mixed with sand, gravel, and water, then poured.		
Plastic	Like asphalt tile in composition but is heated on the job and troweled onto floor to form a seamless flooring. Often used over concrete for durable, resilient surface.	(Same as asphalt tile.)	Synthetic resins: These "synthetics," "resins," or "polishes" intend to offer advantages of wax without the slipperiness.
Wood	Either soft or hard, in variety of thicknesses and designs.	Metallic particles and artificial abrasives in varnish or paint give good nonslip qualities.	
Cork tile	Molded and compressed ground cork bark with natural resins of the cork to bind the mass together when heat cured under pressure.	(Same as asphalt tile.)	
Steel	Iron containing carbon in any amount up to about 1.7 percent as an alloying constituent, and malleable when used under suitable conditions.	Surface can be touched up with an arc welding electrode so that raised places on surface resemble angle worms. An abrasive reinforced plastic coating can be painted on (dries hard as cement and has a sandpaper-like finish). A temporary nonskid surface can be yielded by: (1) flexible rubber mats made of automobile tires; (2) rubber or vinyl runners.	Other materials. Paint, enamel, shellac, varnish, plastic, are semi-permanent finishes used on wood and concrete floors. Do not materially increase slipperiness of the base.
Clay and quarry tile	Kiln-dried clay products are similar to bricks and are used in areas requiring wet cleaning.	Typically resistant to abrasives.	May be treated by etching. May be formulated as nonslip by adding carborundum or aluminum oxide when mixing the clay before kilning.

\*Floors and stairways should be designed to have slip-resistant surfaces insofar as possible; adhesive carborundum strips may be used on stair treads or ramps and critical concrete areas. Etching with mild hydrochloric (muriatic) acid solution will lessen slip problems.

\*\*Colloidal silica is an opalescent, aqueous solution containing 30 percent amorphous silicon dioxide and a small amount of alkali as a stabilizer.

# 3

## Stairways and Ladders

Stairways and ladders are a major source of injuries and fatalities among workers. OSHA estimates that there are 24,882 injuries and as many as 36 fatalities per year due to falls from stairways and ladders used in construction. Nearly half of these injuries are serious enough to require time off the job—11,570 lost workday injuries and 13,312 non-lost workday injuries occur annually due to falls from stairways and ladders used in construction. These data demonstrates that work on and around ladders and stairways is hazardous. More importantly, they show that compliance with OSHA requirements for the safe use of ladders and stairways could have prevented many of these injuries.

The OSHA rules apply to all stairways and ladders used in industry, alteration, repair (including painting and decorating), and demolition of work sites covered by OSHA safety and health standards. They also specify when stairways and ladders must be provided. They do not apply to ladders that are specifically manufactured for scaffold access and egress, but they do apply to job-made and manufactured portable ladders intended for general purpose use that are then used for scaffold access and egress.

Most of this chapter material is taken from the U.S. Department of Labor's publication *Stairways and Ladders* (OSHA 3124). Additions to the chapter are indicated by the standards number from the *North Carolina Occupational Safety and Health Standards for General Industry*.

### **General Requirements**

The following general requirements apply to construction covered under 29 CFR Part 1926:

- A stairway or ladder must be provided at all worker points of access where there is a break in elevation of 19 inches (48 cm) or more and no ramp, runway, sloped embankment or personnel hoist is provided.
- When there is only one point of access between levels, it must be kept clear to permit free passage by workers. If free passage becomes restricted, a second point of access must be provided and used.
- All stairway and ladder fall protection systems required by these rules must be installed and all duties required by the stairway and ladder rules must be performed before employees begin work that requires them to use stairways or ladders and their respective fall protection systems.

### **Stairways**

The following general requirements apply to all stairways used in construction and general industry:

- Stairways that will not be a permanent part of the structure on which construction work is performed must have landings at least 30 inches deep and 22 inches wide (76 × 56 cm) at every 12 feet (3.7 m) or less of vertical rise.
- Stairways must be installed at least 30 degrees, and no more than 50 degrees, from the horizontal.
- Variations in riser height or stair tread depth must not exceed ¼ inch in any stairway system, including any foundation structure used as one or more treads of the stairs.
- Where doors or gates open directly onto a stairway, a platform must be provided that extends at least 20 inches (51 cm) beyond the swing of the door.
- Metal pan landings and metal pan treads must be secured in place before filling.
- All stairway parts must be free of dangerous projections such as protruding nails.
- Slippery conditions on stairways must be corrected.
- Spiral stairways that will not be a permanent part of the structure may not be used by workers.

The following requirements apply to stairs in temporary service during construction:

- Except during construction of the actual stairway, stairways with metal pan landings and treads must not be used where the treads and/or landings have not been filled in with concrete or other material, unless the pans of the stairs and/or landings are temporarily filled in with wood or other material. All temporary treads and landings must be replaced when worn below the top edge of the pan.
- Except during construction of the actual stairway, skeleton metal stairs (where treads and/or landings are to be installed at a later date) must not be used unless the stairs are fitted with secured temporary treads and landings.
- Temporary treads must be made of wood or other solid material and installed the full width and depth of the stair.

### ***Stairrails and Handrails***

The following general requirements apply to all stairrails and handrails:

- In construction, every flight of stairs having four or more risers or rising more than 30 inches (76 cm), whichever is less, must be equipped with one stairrail system along each unprotected side or edge; and at least one handrail. In general industry, standard stair railings and/or standard handrails must be used. See 1910.23(d).
- Winding or spiral stairways must be equipped with a handrail to prevent using areas where the tread width is less than 6 inches (15 cm).
- Stairrails installed after March 15, 1991, must not be less than 36 inches (91.5 cm) in height. (If installed before March 15, 1991, not less than 30 inches [76 cm]).
- Screens, mesh, intermediate vertical members or equivalent intermediate structural members must be provided between the top rail and stairway steps of the stairrail system.
- Screens or mesh, when used, must extend from the top rail to the stairway step and along the opening between top rail supports.
- Midrails, when used, must be located midway between the top of the stairrail system and the stairway steps.
- Intermediate vertical members, such as balusters, when used, must not be more than 19 inches (48 cm) apart.
- Other intermediate structural members, when used, must be installed so that there are no openings of more than 19 inches (48 cm) wide.
- Handrails and the top rails of the stairrail systems must be capable of withstanding, without failure, at least 200 pounds (890 n) of weight applied within 2 inches (5 cm) of the top edge in any downward or outward direction, at any point along the top edge.
- The height of handrails must not be more than 37 inches (94 cm) or less than 30 inches (76 cm) from the upper surface of the handrail to the surface of the tread. When the top edge of a stairrail system also serves as a handrail, the height of the top edge must not be more than 37 inches (94 cm) or less than 36 inches (91.5 cm) from the upper surface of the handrail to the surface of the tread.
- Stairrail systems and handrails must be surfaced to prevent injuries such as punctures or lacerations and to keep clothing from snagging.
- Handrails must provide an adequate handhold for employees to grasp to prevent falls.
- The ends of stairrail systems and handrails must be constructed to prevent dangerous projections such as rails protruding beyond the end posts of the system.
- Temporary handrails must have a minimum clearance of 3 inches (8 cm) between the handrail and walls, stairrail systems and other objects.
- Unprotected sides and edges of stairway landings must be provided with standard 42-inch (1.1 m) guardrail systems.

## ***Ladders***

The following general requirements apply to all ladders, including job-made ladders:

- A double-cleated ladder or two or more ladders must be provided when ladders are the only way to enter or exit a work area having 25 or more employees or when a ladder serves simultaneous two-way traffic. See 1926.1051(a)(2).
- Ladder rungs, cleats and steps must be parallel, level and uniformly spaced when the ladder is in position for use.
- Trestle ladders or extension sections or base sections of extension trestle ladders must not be more than 20 feet in length. See 1910.25(c)(3)(v).
- The spacing of rungs and steps must be on 12-inch centers. Rungs and steps must be corrugated, knurled, dimpled, coated with skid-resistant material or otherwise treated to minimize the possibility of slipping. See 1910.26(a)(1)(v) and 1910.27(b)(1)(ii).
- Ladders must not be tied or fastened together to create longer sections unless they are specifically designed for such use.
- A metal spreader or locking device must be provided on each stepladder to hold the front and back sections in an open position when the ladder is being used.
- Two or more separate ladders used to reach an elevated work area must be offset with a platform or landing between the ladders, except when portable ladders are used to gain access to fixed ladders.
- Ladder components must be surfaced to prevent injury from punctures or lacerations and to prevent snagging of clothing.
- Wood ladders must not be coated with any opaque covering, except for identification or warning labels, which may be placed only on one face of a side rail.

## ***Portable Ladders***

- Nonself-supporting and self-supporting portable ladders must support at least four times the maximum intended load; extra heavy-duty type 1A metal or plastic ladders must sustain 3.3 times the maximum intended load. The ability of a self-supporting ladder to sustain loads must be determined by applying the load to the ladder in a downward vertical direction. The ability of a nonself-supporting ladder to sustain loads must be determined by applying the load in a downward vertical direction when the ladder is placed at a horizontal angle of 75.5 degrees. See 1926.1053(a)(1)(ii).
- The user should equip all portable rung ladders with nonslip bases when there is a hazard of slipping. Nonslip bases are not intended as a substitute for care in safely placing, lashing, or holding a ladder that is being used upon oily, metal, concrete or slippery surfaces. See 1910.25(d)(2)(xix).
- The minimum width between side rails for portable metal ladders must be 12 inches.
- The rungs and steps of portable metal ladders must be corrugated, knurled, dimpled, coated with skid-resistant material or treated to minimize slipping. See 1910.26(a)(1)(v).

## ***Fixed Ladders***

- The minimum design live load must be a single concentrated load of 200 pounds. The number and position of additional concentrated live-load units of 200 pounds each as determined from anticipated usage of the ladder must be considered in the design. See 1910.27(a)(1)(i) and 1910.27(a)(1)(ii).
- The live loads imposed by persons occupying the ladder must be considered to be concentrated at such points as will cause the maximum stress in the structural member being considered. See 1910.27(a)(1)(iii).
- The side rails of through or side-step ladder extensions must extend 42 inches (1.1 m) above parapets and landings. For through ladder extensions, the rungs must be omitted from the extension and must not have less than 18 or more than 24 inches clearance between rails. For side-step or offset fixed ladder sections, at landings, the side rails and rungs must be carried to the next regular rung beyond or above the 42 inch minimum. See 1910.27(d)(3).

- Design stresses for wood components of ladders must not exceed those specified in 1910.25. All wood parts must be free from sharp edges and splinters; sound and free from accepted visual inspection from shake, wane compression failures, decay or other irregularities. Low density wood must not be used. See 1910.25(b)(1)(i) and 1910.27(a)(2).
- The minimum clear length of rungs or cleats must be 16 inches (41 cm). The distance between rungs, cleats and steps must not exceed 12 inches and must be uniform throughout the length of the ladder. See 1910.27(b)(1)(iii) and 1910.27(b)(1)(ii).
- The rungs and steps of fixed metal ladders manufactured after March 15, 1991, must be corrugated, knurled, dimpled, coated with skid-resistant material or treated to minimize slipping. See 1926.1053(a)(6)(i).
- The minimum perpendicular clearance between the centerline of fixed ladder rungs, cleats, steps and any obstruction on the climbing side of the ladder must be 30 inches (76 cm). When unavoidable obstructions are encountered, the distance may be reduced to 24 inches (61 cm), provided that a deflection device is installed to guide employees around the obstruction.
- The step-across distance from the nearest edge of ladder to the nearest edge of equipment or structure must not be more than 12 inches, or less than 2½ inches. See 1910.27(c)(6).
- A clear width of at least 15 inches (38 cm) must be provided each way from the centerline of the ladder in the climbing space, except when cages or wells are necessary.
- Where the total length of a climb on a fixed ladder equals or exceeds 24 feet (7.3 m), one of the following requirements must be met: fixed ladders must be equipped with either (a) ladder safety devices; (b) self-retracting lifelines with rest platforms at intervals not to exceed 150 feet (45.7 m); or (c) a cage or well, and multiple ladder sections, each ladder section not to exceed 50 feet (15.2 m) in length. Ladder sections must be offset from adjacent sections, and landing platforms must be provided at maximum intervals of 50 feet (15.2 m). (This applies to construction. See 1926.1053(a)(19). For general industry requirements see 1910.27(d)(2).)
- The side rails of through or side-step fixed ladders must extend 42 inches (1.1 m) above the top level or landing platform served by the ladder. For a parapet ladder, the access level must be at the roof if the parapet is cut to permit passage through it. If the parapet is continuous, the access level is the top of the parapet.

### ***Cages for Fixed Ladders***

- Horizontal bands must be fastened to the side rails of rail ladders or directly to the structure, building or equipment for individual-rung ladders.
- Vertical bars must be on the inside of the horizontal bands and must be fastened to them.
- Cages must not extend less than 27 inches (68 cm) or more than 30 inches (76 cm) from the centerline of the step or rung and must not be less than 27 inches (68 cm) wide.
- The inside of the cage must be clear of projections.
- Horizontal bands must be spaced at intervals not more than 4 feet (1.2 m) apart measured from centerline to centerline.
- Vertical bars must be spaced at intervals not more than 9.5 inches (24 cm) apart measured from centerline to centerline.
- The bottom of the cage must be between 7 feet (2.1 m) and 8 feet (2.4 m) above the point of access to the bottom of the ladder. The bottom of the cage must be flared not less than 4 inches (10 cm) between the bottom horizontal band and the next higher band.
- The top of the cage must be a minimum of 42 inches (1.1 m) above the top of the platform or the point of access at the top of the ladder. Provisions must be made for access to the platform or other point of access.

## ***Wells for Fixed Ladders***

- Wells must completely encircle the ladder.
- Wells must be free of projections.
- The inside face of the well on the climbing side of the ladder must extend between 27 inches (68 cm) and 30 inches (76 cm) from the centerline of the step or rung.
- The inside width of the well must be at least 30 inches (76 cm).
- The bottom of the well above the point of access to the bottom of the ladder must be between 7 feet (2.1 m) and 8 feet (2.4 m).

## ***Ladder Safety Devices and Related Support Systems for Fixed Ladders***

- All safety devices must be capable of withstanding, without failure, a drop test consisting of a 500-pound weight (226 kg) dropping 18 inches (41 cm).
- All safety devices must permit the worker to ascend or descend without continually having to hold, push or pull any part of the device, leaving both hands free for climbing.
- All safety devices must be activated within 2 feet (.61 m) after a fall occurs and must limit the descending velocity of an employee to 7 feet/second (2.1 m/sec) or less.
- The connection between the carrier or lifeline and the point of attachment to the body belt or harness must not exceed 9 inches (23 cm) in length.

## ***Mounting Ladder Safety Devices for Fixed Ladders***

- Mountings for rigid carriers must be attached at each end of the carrier, with intermediate mountings, spaced along the entire length of the carrier, to provide the necessary strength to stop workers' falls.
- Mountings for flexible carriers must be attached at each end of the carrier. Cable guides for flexible carriers must be installed with a spacing between 25 feet (7.6 m) and 40 feet (12.2 m) along the entire length of the carrier, to prevent wind damage to the system.
- The design and installation of mountings and cable guides must not reduce the strength of the ladder.
- Side rails and steps or rungs for side-step fixed ladders must be continuous in extension.

## ***Use of All Ladders (Including Job-made Ladders)***

- When portable ladders are used for access to an upper landing surface, the side rails must extend at least 3 feet (.9 m) above the upper landing surface. When such an extension is not possible, the ladder must be secured, and a grasping device such as a grab rail must be provided to assist workers in mounting and dismounting the ladder. A ladder extension must not deflect under a load that would cause the ladder to slip off its support.
- Ladders must be maintained free of oil, grease and other slipping hazards.
- Ladders must not be loaded beyond the maximum intended load for which they were built or beyond their manufacturer's rated capacity.
- Ladders must be used only for the purpose for which they were designed.
- Nonself-supporting ladders must be used at an angle where the horizontal distance from the top support to the foot of the ladder is approximately one-quarter of the working length of the ladder. Wood job-made ladders with spliced side rails must be used at an angle where the horizontal distance is one-eighth the working length of the ladder.
- Fixed ladders must be used at a pitch no greater than 90 degrees from the horizontal, measured from the back side of the ladder.
- Ladders must be used only on stable and level surfaces unless secured to prevent accidental movement.



- Ladders must not be used on slippery surfaces unless secured or provided with slip-resistant feet to prevent accidental movement. Slip-resistant feet must not be used as a substitute for the care in placing, lashing or holding a ladder upon slippery surfaces.
- The area around the top and bottom of the ladders must be kept clear.
- The top of a nonself-supporting ladder must be placed with two rails supported equally unless it is equipped with a single support attachment.
- Ladders must not be moved, shifted or extended while in use.
- Ladders must have nonconductive siderails if they are used where the worker or the ladder could contact exposed energized electrical equipment.
- Cross-bracing on the rear section of stepladders must not be used for climbing unless the ladders are designed and provided with steps for climbing on both front and rear sections.
- Ladders must be inspected by a competent person for visible defects on a periodic basis and after any incident that could affect their safe use.
- Single-rail ladders must not be used.
- When ascending or descending a ladder, the worker must face the ladder.
- Each worker must use at least one hand to grasp the ladder when moving up or down the ladder.
- A worker on a ladder must not carry any object or load that could cause the worker to lose balance and fall.

### ***Structural Defects***

- Portable ladders with structural defects, such as broken or missing rungs, cleats, or steps, broken or split rails, corroded components, or other faulty or defective components, must immediately be marked defective or tagged with “Do Not Use” or similar language and withdrawn from service until repaired.
- Fixed ladders with structural defects—such as broken or missing rungs, cleats, or steps, broken or split rails, or corroded components—must be withdrawn from service until repaired.
- Defective fixed ladders are considered withdrawn from use when they are (a) immediately tagged with “Do Not Use” or similar language; (b) marked in a manner that identifies them as defective; or (c) blocked (such as with a plywood attachment that spans several rungs).
- Ladder repairs must restore the ladder to a condition meeting its original design criteria before the ladder is returned to use.

### ***Training Requirements***

Under the provisions of the standard, employers must provide a training program for each employee using ladders and stairways. The program must enable each employee to recognize hazards related to ladders and stairways and to use proper procedures to minimize these hazards. For example, employers must ensure that each employee is trained by a competent person in the following areas, as applicable:

- The nature of fall hazards in the work area;
- The correct procedures for erecting, maintaining and disassembling the fall protection systems to be used;
- The proper construction, use, placement and care in handling of all stairways and ladders; and
- The maximum intended load-carrying capacities of ladders used.

In addition, retraining must be provided for each employee, as necessary, so that the employee maintains the understanding and knowledge acquired through compliance with the standard.

## ***Terms and Definitions***

***Cleat***—A ladder crosspiece of rectangular cross section placed on edge upon which a person may step while ascending or descending a ladder.

***Double-Cleat Ladder***—A ladder with a center rail to allow simultaneous two-way traffic for employees ascending or descending.

***Failure***—Load refusal, breakage or separation of components.

***Fixed Ladder***—A ladder that cannot be readily moved or carried because it is an integral part of a building or structure.

***Handrail***—A rail used to provide employees with a handhold for support.

***Job-made Ladder***—A ladder that is fabricated by employees, typically at the construction site; not commercially manufactured.

***Load Refusal***—The point where the structural members lose their ability to carry the load.

***Point of Access***—All areas used by employees for work-related passage from one area or level to another.

***Portable Ladder***—A ladder that can be readily moved or carried.

***Riser Height***—The vertical distance from the top of a tread or platform/landing to the top of the next higher tread or platform/landing.

***Side-step Fixed Ladder***—A fixed ladder that requires a person to get off at the top to step to the side of the ladder side rails to reach the landing.

***Single-Cleat Ladder***—A ladder consisting of a pair of side rails connected together by cleats, rungs, or steps.

***Stairrail System***—A vertical barrier erected along the unprotected sides and edges of a stairway to prevent employees from falling to lower levels.

***Temporary Service Stairway***—A stairway where permanent treads and/or landings are to be filled in at a later date.

***Through Fixed Ladder***—A fixed ladder that requires a person getting off at the top to step between the side rails of the ladder to reach the landing.

***Tread Depth***—The horizontal distance from front to back of a tread, excluding nosing, if any.

# Construction Industry Fall Protection Requirements

## 1926 Subpart M

**Fall protection** is a broad concept that includes training, procedures, rules, systems and methods intended to protect workers from fall hazards. Fall protection doesn't mean bulky or cumbersome equipment, it doesn't interfere with work tasks, and it doesn't get in the way of co-workers—if you understand the concept and apply it appropriately. Fall protection also implies shared responsibilities. If you are an employer, you must be aware of fall hazards, and you must eliminate them or control your employees' exposure to them. If you are an employee, you are responsible for following the policies, procedures and training requirements established by your employer. Building owners and managers, architects, engineers, and equipment manufacturers also have responsible roles to play during a typical construction project. This guide will help you understand the fall protection concept and how it applies to the construction industry in North Carolina. Words and terms used that pertain to standard requirements are defined within this publication.

In North Carolina, during the period of October 2003 through September 2009, a total of 395 fatalities were reported, 19 percent resulting from falls. In fiscal year 2006, there was a series high of 29 construction fatalities, 14 of which were from falls (48 percent of the fatalities in construction that year were from falls). In fiscal year 2009, 27 percent of the construction fatalities were from falls. Each year, falls consistently account for the greatest number of fatalities in the construction industry and are always a major concern in other industries.

North Carolina established a Special Emphasis Program (SEP) for Construction Activities to decrease fatalities related to the construction industry (NAICS 236-238). Because falls have been the leading cause of death in construction, preventing them is a major component of this program. Events surrounding these types of accidents often involve a number of factors, including unstable working surfaces, misuse of fall protection equipment and human error. Studies have shown that the use of guardrails, fall arrest systems, safety nets, covers and travel restriction systems can prevent many deaths and injuries from falls.

OSHA standards require fall protection in construction when working from unguarded surfaces above 6 feet (or 10 feet on scaffolds) or at any height when above machinery or equipment. For steel erection, however, 1926 Subpart R, state-specific modifications to the new OSHA Subpart R have been approved and are addressed in 13 NCAC 07F .0205. In general, "steel erection" activity now requires fall protection at heights greater than 15 feet, with exceptions for connectors and deckers in a "controlled decking zone" between 15 and 30 feet. All steel erection workers must be protected at heights greater than two stories or 30 feet. Employees engaged in leading edge work require fall protection at 6 feet.

### *Training Workers About Fall Protection*

#### **Employer Responsibilities**

If you are an employer, you need to be aware of fall hazards at your workplace, and you must act to minimize those hazards. Selecting fall protection is the first step toward meeting that responsibility. The second step is training workers so they are familiar with the fall protection they will use. Subpart M, 1926.503, requires employers to provide training for all workers exposed to fall hazards. A competent person must provide training that ensures workers will recognize and use appropriate procedures to minimize exposure. In addition, workers who use personal fall-arrest systems must know:

- How to wear the equipment
- The proper hookup and attachment methods for the equipment
- Appropriate anchoring and tie-off techniques
- How to estimate free fall distances
- Inspection and storage procedures for the equipment
- Self-rescue procedures and techniques

## Retraining

Workers who do not recognize fall hazards at a particular work area must be retrained. Other reasons for retraining include changes that make earlier training obsolete, changes in the types of fall protection equipment used by workers, or a worker's failure to use fall protection equipment effectively.

## Documenting Training

Employers must maintain a written record of each worker's fall protection training. The record must document the worker's name, the date worker was trained, and the trainer's signature.

## Low-slope Roofs and Steep Roofs

Fall protection as addressed in Subpart M, 1926.500(b), defines a roof—relative to any roof—as the exterior surface on the top of a building. However, concrete form work or a floor that temporarily becomes the top surface of a building under construction is not a roof. Subpart M classifies roofs into two types: **low slope** and **steep**. A roof's pitch is the measure of a roof's slope or angle of incline. It is the measured vertical rise divided by the measured horizontal span. The unit of measure for the vertical rise and the run (horizontal span) needs to be the same, e.g., feet over feet, inches over inches. A roof's pitch is simply a ratio of the two. Pitch and slope are two ways of expressing the same measurement. Terminology used to describe roof pitch or slope, includes 4/12, 4:12, 4-12, 4 in 12, 4 and 12, 4 on 12, and 4 to 12.

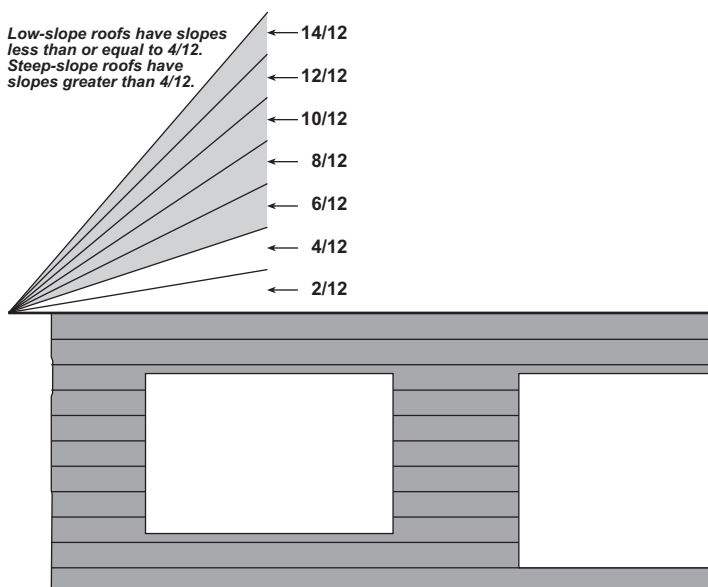

### Low-slope Roofs—Roofs With Slopes Less Than or Equal to 4/12 (Vertical to Horizontal)

If you do roofing work on a low-slope roof with unprotected sides and edges and you are 6 feet or more above a lower level, you must use one of the following fall protection systems:

- Guardrail system
- Safety net system
- Personal fall arrest system (PFAS)
- Warning line system and guardrail system
- Warning line system and safety-net system
- Warning line system and personal fall arrest system
- Warning line system and safety-monitoring system
- *Safety-monitoring system* (if the roof is no wider than 50 feet)

### Steep Roofs—Roofs With Slopes Greater Than 4/12

If you do roofing work on a steep roof with unprotected sides and edges and you are 6 feet or more above a lower level, you must use one of the following fall protection systems:

- Guardrail system with toeboards
- Safety net system
- Personal fall arrest system (PFAS)

Angles of Common Roof Pitches

Roof Pitch	Angle	Roof Pitch	Angle
2/12	9.4	10/12	39.8
3/12	14.0	11/12	42.2
4/12	18.2	12/12	45.0
5/12	22.6	13/12	47.2
6/12	26.5	14/12	49.3
7/12	30.2	15/12	51.3
8/12	33.6	16/12	53.1
9/12	36.8	17/12	54.7

*8 foot rise over 12 foot run = 8 in 12 pitch*



*7/12 Roofing Pitch*

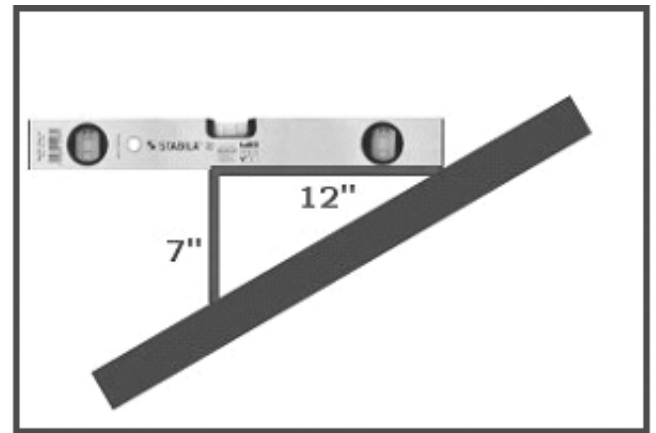

### **Fall Protection Systems and Methods**

A fall protection system refers to equipment designed to control fall hazards. Fall protection systems either prevent falls from occurring or safely arrest falls. Typical fall protection systems include the following:

- Personal fall arrest systems
- Guardrail systems
- Safety net systems
- Warning line systems
- Safety-monitoring systems
- Controlled-access zones

Subpart M does not define “residential construction.” The N.C. Department of Labor’s policy for residential construction is addressed in Operational Procedures Notice (OPN) 109A, wherein the term “residential construction” applies to materials, methods, procedures, fall hazards and fall protection requirements that are essentially the same as those associated with typical house (single-family dwelling) and townhouse construction. Some small institutional and commercial structures fit this definition, as well as parts of a large commercial structure (for example, a shingled entranceway to a mall), but such coverage does not mean that the entire structure is covered by this directive.

The OSH Division recognizes the Subpart M roof pitch of 4 in 12 as the differentiation line between low-slope and steep-slope roofs and the differences in fall protection system possibilities. Further differentiations and caveats in steep-slope roofs (i.e., greater than 4 in 12) that affect fall protection requirements are not recognized in North Carolina.

**Devices such as slide guards and chicken ladders are considered helpful on steep roofs where foot traction is inadequate, but they are not considered adequate substitutes for fall protection systems.** Refer to OPN 109A for more information on the use of slide guards. Alternative measures of fall protection may be used to protect employees when conventional fall protection has been determined to be infeasible or creates a greater hazard.

### ***Conventional Fall Protection***

Personal fall arrest systems, guardrail systems and safety net systems—the most common fall protection systems—are called *conventional fall protection*. Warning lines, safety-monitoring systems, controlled access zones and covers have special applications.

**Personal fall arrest system**



**Guardrails**

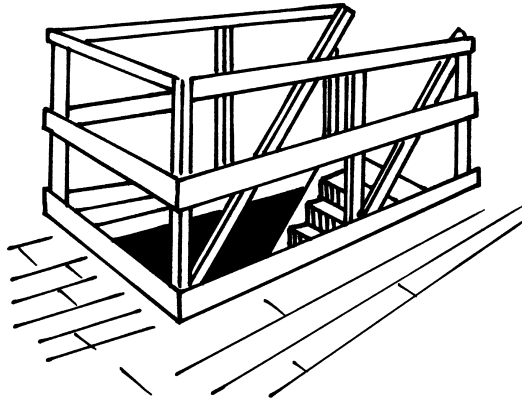

**Safety net**



**The Personal Fall Arrest System**

A personal fall arrest system (PFAS) consists of an *anchor*, *connectors* and a *body harness* that work together to stop one from falling and to minimize the arrest force. Other system components may include a lanyard, a *deceleration device* and a *lifeline*. However, the personal fall arrest system is effective only if you know how the system components arrest a fall. The design and performance requirements for personal fall arrest systems are in Subpart M, 1926.502(d).

**Personal Fall Arrest System Components**

**The anchor**

An anchor provides a secure point of attachment for a lifeline, lanyard or deceleration device and is perhaps the most important personal fall arrest system component. It must support a minimum load of 5,000 pounds—a challenging requirement, particularly on wood-framed and residential-type structures.

If you don't know the weight an anchor point will hold, you should have a *qualified person* design a complete fall protection system. The system must be installed under the supervision of the qualified person, and it must maintain a *safety factor* of at least two—twice the impact force of a worker free falling 6 feet. A qualified person is defined as “one who, by possession of a recognized degree, certificate, or professional standing, or who by extensive knowledge, training, and experience, has successfully demonstrated his ability to solve or resolve problems relating to the subject matter, the work, or the project.” Never use hoists or guardrails as anchors (unless designed and approved). They are not built to withstand the impact forces generated by a fall.

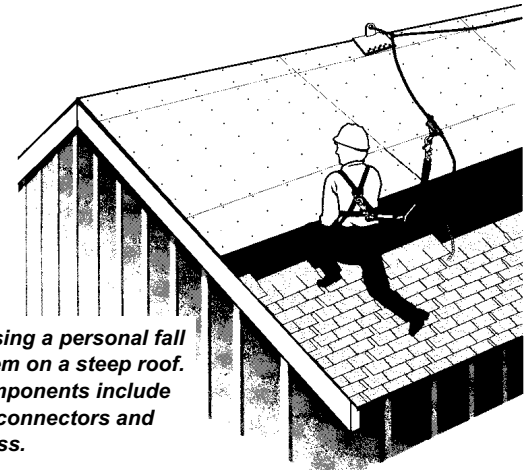

**A worker using a personal fall arrest system on a steep roof. System components include an anchor, connectors and body harness.**

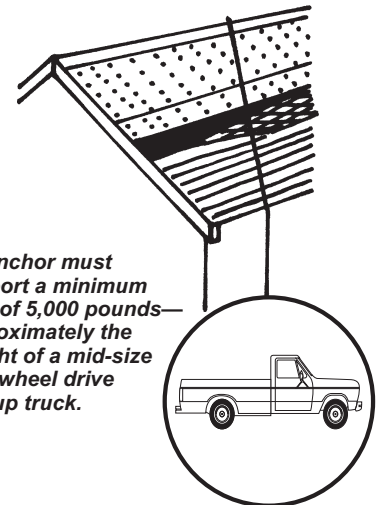

**An anchor must support a minimum load of 5,000 pounds—approximately the weight of a mid-size four-wheel drive pickup truck.**

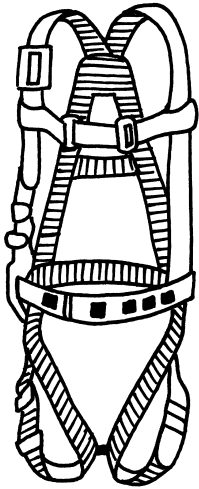

*Body harness*

The **body harness** consists of straps that distribute fall arrest forces over the thighs, waist, chest, shoulders and pelvis. Body harnesses come in many styles most of which are light and comfortable. A basic harness should include a back D-ring for attaching lifelines, lanyards or retractable devices and a back pad for support. A body harness must exert an arresting force of no more than 1,800 pounds on a falling worker. Remember the following when you use a body harness:

- Body harnesses cannot be made from natural fibers.
- Body harnesses are available in different sizes. Make sure the harness fits properly.
- The attachment point of a body harness must be located in the center of the back, about shoulder level.
- Use only body harnesses approved for commercial work. Do not use recreational climbing harnesses.

**Connectors** couple the components of a personal fall arrest system. *D-rings* and *snap hooks* are the most common types of connectors. Connectors must be drop-forged, pressed or made from formed steel or equally strong material. They must be corrosion-resistant, with smooth surfaces and edges that will not damage other parts of the personal fall arrest system.

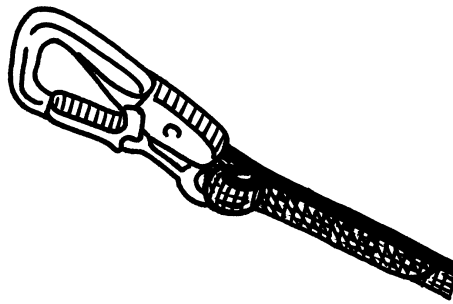

*A locking snap hook*



*Connectors*

***Non-locking snap hooks are prohibited as part of a personal fall arrest system.***



The D-ring, a body harness component, attaches to a deceleration device or to a lanyard. D-rings must have a minimum breaking strength of 5,000 pounds. The snap hook consists of a hook-shaped member and a keeper. It opens to snap onto another component and when released, automatically closes. Snap hooks must also have a minimum breaking strength of 5,000 pounds. There are two types of snap hooks, locking and non-locking. The locking type has a self-locking keeper that will not open until it is unlocked. **Use only locking snap hooks as part of a personal fall arrest system.**

## ***Guidelines for Using Personal Fall Arrest Systems***

### **Plan Anchor Points**

Try to anticipate anchor locations before construction work begins. It is possible to design anchors into a building for window cleaning or other maintenance tasks, for example. During the construction phase, workers can use planned anchors too. A qualified person must design anchor systems installed during construction.

### **Avoid Knots in Rope Lanyards and Lifelines**

Knots can reduce the strength of a lifeline or a lanyard by 50 percent or more. Avoid using knots for tying off to an anchor; use a locking snap hook designed for that purpose.

### **Avoid Tying Lifelines or Lanyards Directly to an I-beam**

By tying a rope lanyard or lifeline around an I-beam, you reduce the rope's strength by 70 percent due to the cutting action of the beam edges. Avoid "tie-offs" around I-beams and any other rough or sharp objects. Use *tie-off adapters* or *beam connectors* to anchor a lifeline or lanyard to the beam.

### **Understand Horizontal Lifeline Forces**

Designing and installing horizontal lifeline anchors are critical activities. The reason relates to the geometry of the horizontal lifeline (anchored at each end) and its *sag angle*, which is the line's angle of deflection when subjected to a load. Reducing the sag angle on a horizontal lifeline increases the forces imposed on the line during a worker's fall. For example, a horizontal lifeline with a 15-degree sag angle will receive twice the impact force as a horizontal lifeline with a 30-degree sag angle. If you decrease the sag angle to 5 degrees, the impact force increases by a factor of six. Two workers can connect to the same horizontal lifeline. If one worker falls, however, the line movement could cause the other worker to fall, subjecting the line and anchors to an even greater impact. For these reasons, horizontal lifelines must be designed, engineered and installed under the supervision of a qualified person.

### **Be Cautious With Eyebolt Connections**

The strength of an eyebolt is rated along the axis of the bolt and it is greatly reduced when force is applied at an angle to the axis. Avoid connections to eyebolts that might cause such an effect during a fall.

### **Consider Total Fall Distances**

Personal fall arrest systems are designed to stop workers who experience *free falls*. Free fall is the part of the fall before the arrest system starts to take effect. However, even after the system activates, a worker will continue to fall. The distance a worker falls includes the free-fall distance, the lifeline's stretch from the force of the fall, and the deceleration distance required to absorb shock. Free fall distance is limited to 6 feet (less if a worker could strike an object or lower level). Lifeline stretch and deceleration distance cannot exceed 3.5 feet. Therefore, a worker wearing a personal fall arrest system could fall up to 9.5 feet before stopping (6 feet plus 3.5 feet). OSH requires that personal fall arrest systems be rigged so that workers do not free fall more than 6 feet or strike a lower level.

**Rigging:** Anchor points should be as high as possible, but at least at or above the connection point on the harness. The ideal height is 7 feet above the work surface, to limit the fall distance. Workers must be tied off in a manner that ensures no lower level or other surfaces are struck during a fall. This is especially important when using shock-absorbers. These units may elongate as much as 42 inches during the shock-absorption process. A worker of average height using a 5-foot shock-absorbing lanyard in conjunction with a sliding back D-ring must tie-off at a point at least 14½ feet from a lower level to ensure no contact.

**Note:** When using a manufacturer's fall protection components or complete system, the manufacturer's recommendations and installation instructions must be followed. All users of fall protection systems must be trained on the safe use of the system. All systems must be inspected prior to use upon installation and before each day's use. Systems must also be inspected at intervals as established by the manufacturer. A rescue program must be set up prior to using any fall arrest system or use of a system designed for self-rescue.

### **Avoid Swing Falls**

If you use a personal fall arrest system and are not working directly below the tie-off anchor, you will swing back under the anchor during a fall. Swing falls are especially hazardous because you can hit an object or a lower level during the pendulum motion. Remember the following about swing falls:



*Swing falls can actually increase fall distance.*

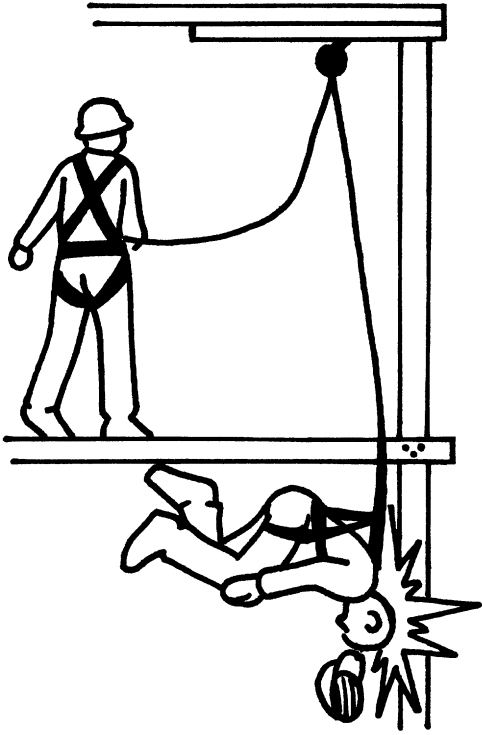

### Lifelines

A lifeline is flexible cable or rope that connects to a body harness, lanyard or deceleration device and at least one anchor. There are two types of lifelines, *vertical* and *horizontal*. A vertical lifeline attaches directly to a body harness, lanyard or deceleration device and to an anchor (and hangs vertically, hence the name). Vertical lifelines must have a minimum breaking strength of 5,000 pounds.

The *self-retracting lifeline* is both a vertical lifeline and a deceleration device. It consists of a drum-wound line that unwinds and retracts from the drum as a worker moves. If the worker falls, the drum automatically locks. Self-retracting lifelines that automatically limit free fall distance to 2 feet or less must have a minimum breaking strength of 3,000 pounds. Self-retracting lifelines that do not limit free fall distance to 2 feet or less must have a minimum breaking strength of 5,000 pounds. Self-retracting lifelines are not recommended to be attached to horizontal lifelines because of the ratcheting (bouncing) effect. Horizontal lifelines must be designed, installed and used, under the supervision of a qualified person. Horizontal lifelines are subject to greater loads than vertical lifelines and must be properly designed and installed. If not properly anchored to rigid connection points, this type of lifeline system can fail at the anchor point.

Fall distance can actually increase during a swing fall. The impact force from a swing fall can be the same as it would be for a vertical fall with the same change of elevation. During a swing fall, you can strike an object or lower level before the arrest system stops your fall.

### Deceleration Devices

You can reduce fall-impact forces on an anchor (and yourself) by minimizing the fall distance and using a deceleration device, such as a shock-absorbing lanyard or self-retracting lifeline. A third type of deceleration device is the *rope grab*, a mechanism that allows you to move up and down a vertical lifeline. The rope grab automatically locks onto the lifeline if you fall. Always follow manufacturers' instructions when you use deceleration devices.

### Two types of deceleration devices

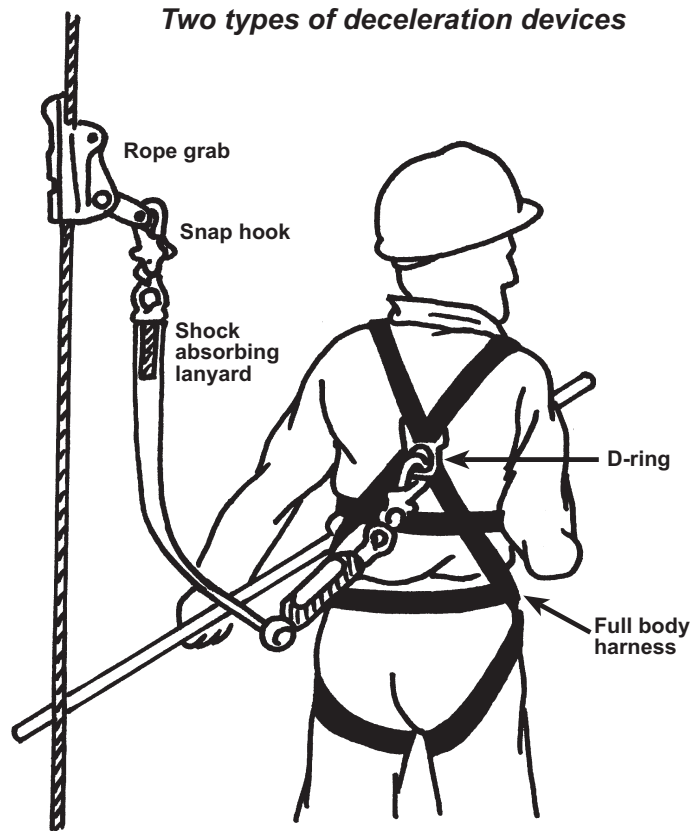

## Guardrail Systems

Guardrail systems are vertical barriers consisting of top rails, *midrails* and intermediate vertical members. Guardrail systems can also be combined with toeboards, which are barriers that prevent materials and equipment from dropping to lower levels. You can use guardrail systems without toeboards for fall protection on low-slope roofs. On steep roofs, use guardrail systems with toeboards to protect from falls and falling objects. Design and performance requirements for guardrail systems are in Subpart M, 1926.502(b), and include the following:

- Guardrail systems must be free of anything that might cut a worker or snag a worker's clothing. All guardrails must be at least 1/4-inch thick to reduce the risk of hand lacerations. Steel or plastic banding is not permitted for top rails or midrails.
- Wire rope used for a top rail must be marked at least every 6 feet with high-visibility material.
- The top edge of a guardrail system must be 42 inches, plus or minus 3 inches, above the surface to which it is attached. The top-edge height can exceed 45 inches when conditions warrant; however, the guardrail system must meet all other performance criteria. Note: When employees are using stilts, the top edge height of the top rail, or equivalent member, shall be increased an amount equal to the height of the stilts.
- Where there is no wall or parapet at least 21 inches high, screens, mesh, midrails or similar protection must be installed between the top edge of the guardrail system and the working surface. Midrails must be installed midway between the top edge of the guardrail system and the working surface. Screens or mesh must extend from the top rail to the working surface.
- Intermediate vertical members, between posts, must be no more than 19 inches apart.
- The guardrail system must be capable of withstanding a 200-pound force applied within 2 inches of its top edge, in any outward or downward direction. Midrails, screens and intermediate structural members must withstand at least 150 pounds applied in any outward or downward direction.

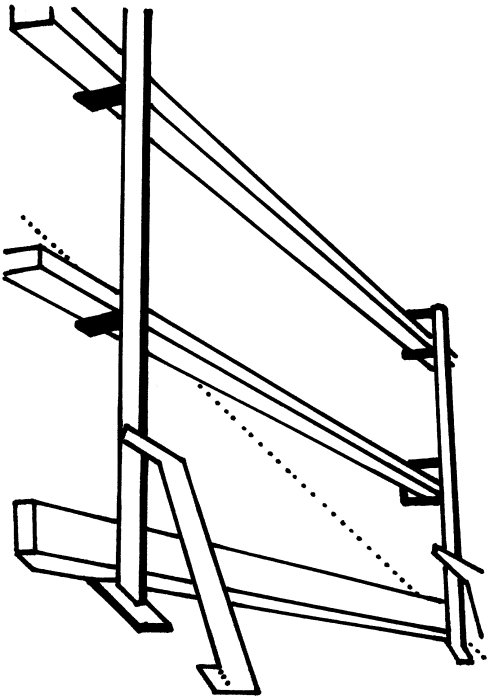

*Guardrail system on steep roof*

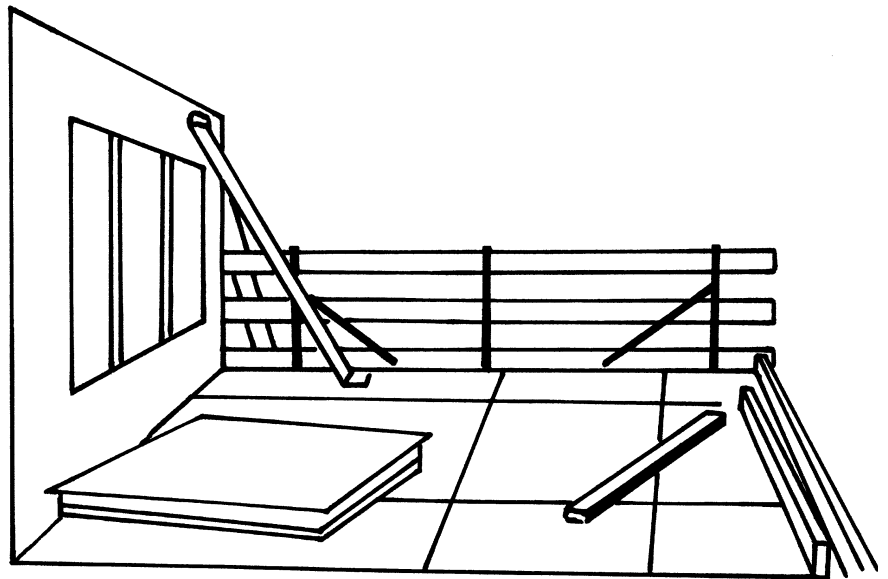

*Guardrail system with toeboards*

## Safety net systems

Safety net systems consist of mesh nets, panels and connecting components. They are typically used as protection for those who work 25 feet or more above lower levels on bridges and at building construction sites. Safety net systems are rarely used for roofing work. The maximum size of each **mesh net opening** must not exceed 36 square inches or longer than 6 inches on a side, measured center to center. The design and performance requirements for safety net systems are in Subpart M, 1926.502(c). Safety nets must be installed as close as possible below working surfaces, but not more than 30 feet below the surfaces. An installed net must withstand a **drop test** consisting of a 400-pound bag of sand 30 inches in diameter dropped from a working surface. The net must be able to withstand the impact without touching anything below it.

The outer edge of a safety net must be at least 8 feet from the edge of the working surface; however, the minimum distance varies, depending on how far the net is below the working surface. The table below shows the minimum distances.

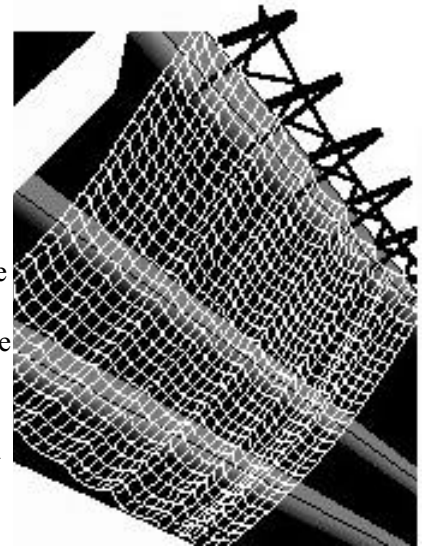

*A safety net system*

Horizontal and Vertical Safety-Net Distance From a Working Surface	
Net Distance Below the Working Surface	Minimum Horizontal Distance to the Net's Outer Edge
Up to 5 Feet	8 Feet
5 to 10 Feet	10 Feet
Greater than 10 Feet	13 Feet

## Other Fall Protection Systems

### Warning Line Systems

Warning line systems consist of ropes, wires or chains and supporting stanchions that form a barrier to warn those who approach an unprotected roof side or edge. The warning lines mark off an area within which one can do roofing work without using guardrails or safety nets. Warning line systems can be combined with guardrail systems, personal fall arrest systems or safety-monitoring systems to protect those doing roofing work on low-slope roofs (4/12 or less). A combined warning line system and safety-monitoring system provides practical, effective fall protection for roofing work on low-slope roofs. Warning line systems on low-slope roofs are also effective for protecting those who don't need to work near an unprotected edge. The design and performance requirements for warning line systems are covered in Subpart M, 1926.502(f).

If you decide to use warning lines, keep the following in mind:

- Set up the warning line around all exposed sides of the roof, 6 feet from the edge.
- Make sure the line has a minimum 500-pound tensile strength.
- Mark the line with high-visibility material every 6 feet.

### Frequently asked question

*Can I use standard plastic caution tape or ribbon for the warning line?*

No. The warning line must have enough strength so that one who leans against the line will not break it. Subpart M, paragraph 1926.502(f), states that only rope, wire or chain with a minimum strength of 500 pounds may be used as a warning line.

## Safety-monitoring Systems

A safety-monitoring system is a set of procedures assigned to a competent person for monitoring and warning workers who may be unaware of fall hazards. Safety-monitoring systems are appropriate for roofing operations on low-slope roofs less than 50 feet wide. You can use a safety-monitoring system combined with a warning line system on low-slope roofs with larger dimensions. A safety-monitoring system combined with a controlled access zone and a *fall protection plan* is **acceptable for situations where conventional fall protection is not feasible**. Keep in mind that a safety-monitoring system consists of fall protection procedures rather than a substantial barrier. Subpart M, 1926.502(h), includes the design and performance requirements for safety-monitoring systems.

## Controlled Access Zones

The controlled access zone defines an area where workers can do *leading edge, overhand bricklaying and related work, or work under a fall protection plan* without using conventional fall protection. All others are prohibited from entering a controlled access zone. You can use a controlled access zone as fall protection for leading-edge work or residential-type construction work only as part of a fall protection plan. You must also include a safety monitor to warn those working within the zone of fall hazards. The control zone consists of a line, or lines, warning workers that access to the zone is restricted to authorized persons. Subpart M, 1926.502(g), includes the design and performance requirements for controlled access zones. Control lines must meet the following criteria:

- Consist of ropes, wires, tapes or equivalent materials and supporting stanchions
- Be flagged at least every 6 feet with high-visibility material
- Be no less than 39 inches from the working surface at its lowest point and no more than 45 inches from the working surface at its highest point (50 inches in overhand bricklaying operations)
- Have a minimum breaking strength of 200 pounds

## Covers

A cover includes any rigid object used to overlay openings in floors, roofs and other walking surfaces. Covers must be able to support at least twice the maximum anticipated load of workers, equipment and materials. Covers should have full-edge bearing on all four sides. Make sure covers are secure and color-code or mark them with the word “HOLE” or “COVER.” Subpart M, 1926.502(i), includes the design and performance requirement for covers.

Fall protection at *sky lights*, 1926.501(b)(4) requires protection from falling through holes (including skylights) more than 6 feet (1.8 m) above lower levels.

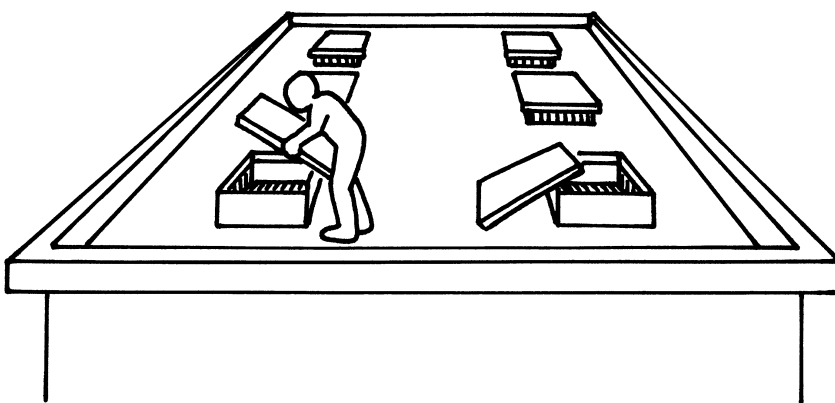

***Make sure holes or floor coverings are covered. Color-code them or mark them with the word “HOLE” or “COVER.”***

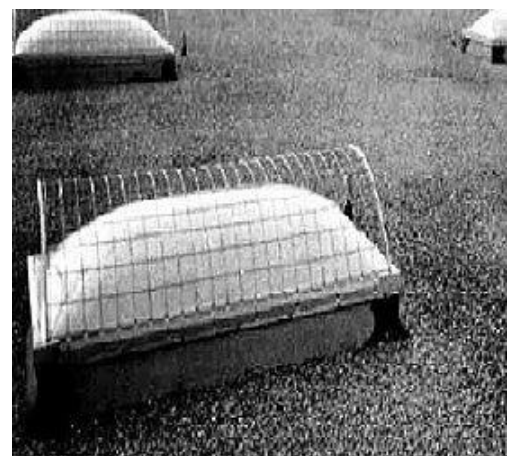

***Note: This picture complies with 1910.23(a)(4).***

## ***Fall Protection in Construction:***

Subpart M of the North Carolina Occupational Safety and Health Standards for the Construction Industry uses more performance-oriented criteria where possible, rather than specification-oriented language.

Each employee on a roof with unprotected sides and edges 6 feet or more above lower levels must be protected from falling by guardrail systems with toeboards, safety net systems or personal fall arrest systems.

Each employee who is constructing a leading edge 6 feet or more above lower levels must be protected from falling by guardrail systems, safety net systems, or personal fall arrest systems. Exception: When the employer can demonstrate that it is infeasible or creates a greater hazard to use these systems, the employer may develop and implement a fall protection plan that meets the requirements of paragraph 1926.502(k).

**Fall protection plan:** Available only to employees engaged in leading edge work, precast concrete erection work or residential construction work who can demonstrate that it is infeasible or it creates a greater hazard to use conventional fall protection equipment. The fall protection plan must be:

- prepared by a qualified person
- developed specifically for the site where the work is being performed, see note
- maintained up to date
- available at the jobsite

The plan must document the reasons why the use of conventional fall protection is infeasible, include a written discussion of other measures that will be taken to eliminate fall hazards, and be implemented under the supervision of a competent person.

Note: The following North Carolina interpretation taken from OPN 109A (N.C. Department of Labor's policy for residential construction) loosens the requirement for "site specific" fall protection plans found in 1926.502(k)(1): "For residential construction, the fall protection plan need not be singularly site specific, but must be applicable to the site and structure, and contain no extraneous material. However, a unique site and/or structure may make a site-specific plan necessary. However, an all-encompassing 'canned' plan which contains material not applicable to the structure at issue is not acceptable."



***Steel Erection***

## ***Steel Erection***

North Carolina state-specific modifications to the new OSHA Subpart R have been approved and are addressed in 13 NCAC 07F .0205. These modifications address the definition of steel erection activities, nontraditional steel erection activities, and the installation of shear connectors. The modifications replace 1926.750(b)(1) and (2) and 1926.754(c)(1) with state-specific requirements to provide guidance relevant to each section listed.



***Leading Edge***



### Fall Protection Requirements for Steel Erection

1. Deckers in a controlled decking zone (CDZ) and connectors must be protected at heights greater than two stories or 30 feet.
2. Connectors between 15 feet and two stories or 30 feet must wear fall arrest or restraint equipment and be able to be tied off or be provided another means of fall protection. Deckers working between 15 feet and two stories or 30 feet may be protected by a CDZ.
3. Fall protection is required at heights greater than 15 feet for all others engaged in steel erection activities (as defined in 1926.750(b)(1)).
4. Employees engaged in leading edge work activities (as defined in 1926.750(b)(2)) must be protected at 6 feet or more above lower levels, by guardrail systems, personal fall arrest systems or safety nets.
5. Employees must be protected from falls due to tripping hazards created by shear connectors.

NCDOL established the following requirement that pertains to 1926.750(b)(2): There may be activities that occur during and are part of steel erection where conventional fall protection methods may not offer adequate protection for employees. The employer has the burden of establishing and determining when to implement employee fall protection measures as described in 1926.760 or the more protective measures described in 1926.502 “Fall Protection Systems Criteria and Practices.” **Where nontraditional steel or iron workers (employees not meeting requirements of 1926.761(c)) are engaged in leading edge work activities 6 feet or more above lower levels, those employees must be protected from falling by guardrail systems, personal fall arrest systems or safety nets.**

### Connector

An employee who, working with hoisting equipment, is placing and connecting structural members and/or components.



*Connector*

### Controlled Decking Zone (CDZ)

An area in which certain work may take place without the use of guardrail systems, personal fall arrest systems, fall restraint systems or safety net systems and where access to the zone is controlled. (For example, initial installation and placement of metal decking).



*Controlled decking zone*





*Leading edge*

### **Leading Edge**

An unprotected side and edge of a floor, roof or formwork for a floor or other walking/working surface that changes location as additional floor, roof, decking or formwork sections are placed, formed or constructed.

### **Metal Decking**

Commercially manufactured, structural grade, cold rolled metal panel formed into a series of parallel ribs. (Metal decking includes metal floor and roof decks, standing seam metal roofs, other metal roof systems, and other products such as bar gratings, checker plate, expanded metal panels and similar products).



*Metal decking*



*Shear connector*

### **Shear Connector**

Steel bars, steel lugs, headed steel studs and similar devices that are attached to a structural member for the purpose of achieving composite action with concrete.

## *Summary of Fall Protection Requirements for Steel Erection*



### **Fall Protection**

- Each employee engaged in steel erection activities on a walking/working surface more than 15 feet above a lower level shall be protected.
- Perimeter safety cables on multi-story buildings will be installed after metal decking is installed.
- Connectors above 30 feet or two stories will be protected.
- At heights above 15 feet and below 30 feet, each employee will wear fall protection equipment or be provided with other means of protection.
- Employees engaged in leading edge work require fall protection at 6 feet.
- Employees must be protected from falls due to tripping hazards created by shear connectors (including, but not limited to headed steel studs, steel bars or steel lugs), reinforcing bars, deformed anchors, or threaded studs attached to the top flanges of beams, joists or beam attachments.

### **Control Decking Zone**

- Only be established in areas from 15 feet to 30 feet above lower level and forms leading edge.
- Employees in CDZ must be provided fall protection.
- Access to CDZ limited to employees doing leading edge work.
- CDZ clearly marked by control lines or equivalent. Max area 90 by 90 feet.
- Unsecured decking must not exceed 3,000 square feet.
- Safety deck attachments (two per panel) shall start at leading edge and proceed to control line.



## Fall Protection Equipment

- Must conform to 1926.502
- Fall protection provided by steel erector must remain in place to be used by other trades if:
  - Controlling contractor directs steel erector to leave in place and
  - Has inspected and assumed responsibility prior to allowing other trades to use.

### §1926.760 Fall Protection

1. All employees must be protected at 15 feet, except for deckers in controlled decking zones and connectors [§.760(a)]
2. Exception for connectors—protected at 30 feet or two stories, whichever is less [§.760(b)]
3. Controlled decking zone requirements [§.760(c)]
4. Exception for deckers working at the leading edge in controlled decking zones—protected at 30 feet or two stories above lower deck, whichever is less [§.760(c)(1)]
5. Criteria for fall protection [§.760(d)]
6. Responsibility of controlling contractors to choose whether to accept responsibility for fall protection equipment [§.760(e)]

## 13 NCAC 07F .0205 CONSTRUCTION

Subpart R-Steel Erection—establish additions and amendments to 29 CFR 1926.750 Scope, through 1926.754 *Definitions applicable to this subpart, as follows:*

### “Section 1926.750 Scope:

**(b)(1)** Steel erection activities include hoisting, laying out, placing, connecting, welding, burning, guying, bracing, bolting, plumbing and rigging structural steel, steel joists, bridge steel girders and metal buildings; installing metal decking and moving point-to-point while performing these activities.

**(b)(2)** There may be activities that occur during and are part of steel erection where conventional fall protection methods may not offer adequate protection for employees. The employer has the burden of establishing and determining when to implement employee fall protection measures as described in 1926.760 or the more protective measures described in 1926.502 “Fall Protection Systems Criteria and Practices”. Where non-traditional steel or iron workers (employees not meeting requirements of 1926.761(c)) are engaged in leading edge work activities 6 (6) feet or more above lower levels, those employees shall be protected from falling by guardrail systems, personal fall arrest systems or safety nets. Such leading edge work activities include, but are not limited to off loading, stacking, laying out and fastening steel floor decking and metal and non-metal roof decking; positioning and securing exterior curtain walls, window walls, exterior siding systems; and moving from point to point while performing these activities.

**1926.754(c)(1)** Tripping hazards. Employees shall be protected from falls due to tripping hazards created by shear connectors (including, but not limited to headed steel studs, steel bars or steel lugs), reinforcing bars, deformed anchors, or threaded studs attached to the top flanges of beams, joists or beam attachments. Such protection from falls may be accomplished by any of the following:

- (1) Shear connectors that project vertically or horizontally across the top flange of a member not being welded or applied until the metal decking or other walking/working surface is installed (field-installed shear connectors).
- (2) All employees working on members with shop or pre-installed shear connectors shall be protected from falling hazards greater than 6 feet by suitable, as defined in 1926.32(s), fall protection systems, including guardrail systems, personal fall arrest systems, or safety nets.
- (3) Shop or pre-installed connectors that project vertically from or horizontally across the top flange of the member shall be covered by a temporary decking, metal or wood box until the metal decking, or other suitable walking/working surface, is installed or until final construction covers the shear connectors.

## ***Q & A Pertaining to Steel Erection***

**Question:** Under 1926.760(c)(2), only those employees involved in “leading edge work” are allowed to have access to the CDZ. The rule defines the term “leading edge” but not “leading edge work.” What constitutes leading edge work in a CDZ?

**Answer:** In a CDZ, leading edge work consists of the placement and initial installation (by safety deck attachments, which typically are tack welds) of decking to create a deck. The leading edge of the deck changes location as this work progresses.

**Question:** At what height are connectors required to be protected from falls? Is there a conflict between 1926.760(b)(1) and 1926.760(b)(3)?

**Answer:** There is not a conflict between 1926.760(b)(1) and 1926.760(b)(3). Section 1926.760(b)(3) requires that at all times between 15 and 30 feet, an employee must be provided with fall protection equipment and be able to tie off. This provision addresses circumstances under which an employer must provide fall protection; whereas, 1926.760(b)(1) addresses when an employee must use the fall protection equipment.

For clarification, under the requirements of 1926.760(b)(1), connectors working on a single-story structure do not need to tie off until they are above 30 feet since the two-story criteria would not apply. Furthermore, connectors working on a multi-story structure do not need to tie off until they are above two stories or 30 feet, whichever is less.

**Question:** Section 1926.760(c)(2) states that “access to a CDZ shall be limited to only those employees engaged in leading edge work.” Installation of perimeter fall protection does not meet the standard’s definition of leading edge work. Are workers prohibited from installing perimeter fall protection in a CDZ?

**Answer:** Installation of perimeter cables inside a CDZ will be considered acceptable or satisfy the intent of 1926.760(c)(2) where all of the following conditions are met: (1) the workers installing the perimeter cables are protected by conventional fall protection, (2) their work does not interfere with the deckers, and (3) they have been trained on the hazards associated with decking.

**Question:** Section 1926.760(c)(2) requires that access to a CDZ be limited to those engaged in leading edge work. Typically one crew lays down the metal decking, and another crew comes behind and tack welds the sheets in place. Can the tack weld work be done in a CDZ?

**Answer:** Yes. Tack welding, if done for safety deck attachments, can be done in a CDZ. Section 1926.760(c)(6) gives criteria for performing safety deck attachments in the CDZ and states that they must be performed from the leading edge back. However, 1926.760(c)(7) does not allow final deck attachments to be performed in a CDZ.

**Question:** Section 1926.760(c)(3) and Appendix D: The suggested example in the appendix states that “any other means that restricts access” may be used instead of control lines. What are some examples of other means?

**Answer:** Section 1926.760(c)(3) requires that the boundaries of the CDZ be marked “by the use of control lines or the equivalent.” In a CDZ, the control line restricts access by visually warning employees of an unprotected area (66 FR 5247). Control lines can be made of rope, wire, tape, or other equivalent materials, but they must clearly designate the CDZ. Examples of other acceptable methods would be a perimeter wall, guardrail system, or even a restraint system rigged so that non-leading edge workers could not access the area. In contrast, a line painted on the floor would not be considered to be equivalent to control lines since it would be less visible than a control line.

## ***Summary of Fall Arrest Systems Specifications***

- Limits falls to 6 feet or less.
- Lifelines may be either vertical or horizontal.
- Lifeline connection points must support 5,000 pounds per person.
- Vertical lifelines may support only one person.
- Horizontal lifelines may support more than one person, but preferably no more than two.
- Only one lifeline may be connected to any one tie-off point.

- Vertical lifelines must be a minimum of  $\frac{5}{8}$  inch in diameter and be capable of supporting 5,000 pounds.
- Horizontal lifelines and their anchor points must be designed for the load with a 2:1 safety factor and be designed by and under control of a qualified person.
- Rope grabs or other approved mechanical devices may be used to connect employees to lifelines.
- Lanyards must not exceed 6 feet in length and must be as short as practical.
- Employees must wear a full body harness with the PFAS after Dec. 31, 1997. Body belts used in a PFAS were illegal Jan. 1, 1998 (Body belts may be acceptable for use as a positioning device).
- The attachment point of the body harness must be located in the center of the wearer's back near shoulder level, or above the wearer's head.
- The attachment point to the lifeline should be above the attachment point of the harness.
- Commercial systems must be installed and used in accordance with the manufacturer's written instructions.
- Components of commercial systems may not be mixed with other commercial systems unless expressly permitted by the manufacturer.
- Lifeline connection points should be directly overhead (or as near to overhead as possible) to prevent swing action.
- Only locking type snaphooks may be used.

### ***Fall Protection and Steel Erection Definitions***

1. ***Choker*** means a wire rope or synthetic fiber rigging assembly that is used to attach a load to a hoisting device.
2. ***Column*** means a load-carrying vertical member that is part of the primary skeletal framing system. Columns do not include posts.
3. ***Competent person*** (also defined in §1926.32) means one who is capable of identifying existing and predictable hazards in the surroundings or working conditions that are unsanitary, hazardous or dangerous to employees and who has authorization to take prompt corrective measures to eliminate them.
4. ***Connector*** means an employee who, working with hoisting equipment, is placing and connecting structural members and/or components.
5. ***Constructibility*** means the ability to erect structural steel members in accordance with Subpart R without having to alter the overall structural design.
6. ***Controlled decking zone*** (CDZ) means an area in which certain work (for example, initial installation and placement of metal decking) may take place without the use of guardrail systems, personal fall arrest systems, fall restraint systems or safety net systems and where access to the zone is controlled.
7. ***Controlling contractor*** means a prime contractor, general contractor, construction manager or any other legal entity that has the overall responsibility for the construction of the project—its planning, quality and completion.
8. ***Fall restraint system*** means a fall protection system that prevents the user from falling any distance. The system comprises either a body belt or body harness, along with an anchorage, connectors and other necessary equipment. The other components typically include a lanyard and may also include a lifeline and other devices.
9. ***Hoisting equipment*** means commercially manufactured lifting equipment designed to lift and position a load of known weight to a location at some known elevation and horizontal distance from the equipment's center of rotation. "Hoisting equipment" includes but is not limited to cranes, derricks, tower cranes, barge-mounted derricks or cranes, gin poles, and gantry hoist systems. A "come-a-long" (a mechanical device, usually consisting of a chain or cable attached at each end, that is used to facilitate movement of materials through leverage) is not considered "hoisting equipment."
10. ***Leading edge*** means the unprotected side and edge of a floor, roof or formwork for a floor or other walking/working surface (such as deck) that changes location as additional floor, roof, decking or formwork sections are placed, formed or constructed.

11. ***Metal decking*** means a commercially manufactured, structural grade, cold rolled metal panel formed into a series of parallel ribs. For this Subpart R, this includes metal floor and roof decks, standing seam metal roofs, other metal roof systems and other products such as bar gratings, checker plate, expanded metal panels and similar products. After installation and proper fastening, these decking materials serve a combination of functions including, but not limited to: a structural element designed in combination with the structure to resist, distribute and transfer loads, stiffen the structure, and provide a diaphragm action; a walking/working surface; a form for concrete slabs; a support for roofing systems; and a finished floor or roof.
12. ***Personal fall arrest system*** means a system used to arrest an employee in a fall from a working level. A personal fall arrest system consists of an anchorage, connectors, a body harness and may include a lanyard, deceleration device, lifeline or suitable combination of these. The use of a body belt for fall arrest is prohibited.
13. ***Positioning device*** means a body belt or body harness rigged to allow an employee to be supported on an elevated, vertical surface, such as a wall or column and work with both hands free while leaning.
14. ***Qualified person*** (also defined in §1926.32) means one who by possession of a recognized degree, certificate or professional standing or who by extensive knowledge, training and experience has successfully demonstrated the ability to solve or resolve problems relating to the subject matter, the work or the project.
15. ***Shear connector*** means headed steel studs, steel bars, steel lugs and similar devices that are attached to a structural member for the purpose of achieving composite action with concrete.
16. ***Steel erection*** means the construction, alteration or repair of steel buildings, bridges and other structures, including the installation of metal decking and all planking used during the process of erection.
17. ***Unprotected sides and edges*** means any side or edge (except at entrances to points of access) of a walking/working surface, for example a floor, roof, ramp or runway, where there is no wall or guardrail system at least 39 inches (1.0 m) high.

**Example of Documentation Form Material**

*Fall protection checklists and training certification form  
(This checklist can be used to identify fall hazards at your worksite).*

<b>Fall Hazard Checklist</b>		
Check all boxes that apply. Check "Yes" if hazards exist at your worksite; check "N/A" if not.		
<b>Hazard</b>	<b>Yes</b>	<b>N/A</b>
Hoist areas	<input type="checkbox"/>	<input type="checkbox"/>
Holes	<input type="checkbox"/>	<input type="checkbox"/>
Formwork	<input type="checkbox"/>	<input type="checkbox"/>
Rebar	<input type="checkbox"/>	<input type="checkbox"/>
Runways	<input type="checkbox"/>	<input type="checkbox"/>
Excavations	<input type="checkbox"/>	<input type="checkbox"/>
Dangerous equipment	<input type="checkbox"/>	<input type="checkbox"/>
Overhand bricklaying	<input type="checkbox"/>	<input type="checkbox"/>
Floor joists and trussing	<input type="checkbox"/>	<input type="checkbox"/>
Floor sheathing	<input type="checkbox"/>	<input type="checkbox"/>
Erecting exterior walls	<input type="checkbox"/>	<input type="checkbox"/>
Roof trussing and raftering	<input type="checkbox"/>	<input type="checkbox"/>
Roof sheathing	<input type="checkbox"/>	<input type="checkbox"/>
Roofing	<input type="checkbox"/>	<input type="checkbox"/>
Wall openings	<input type="checkbox"/>	<input type="checkbox"/>
Falling objects	<input type="checkbox"/>	<input type="checkbox"/>

*The checklist below can be used to identify the fall protection system training each worker received at your worksite.*

<b>Fall Protection System</b>	<b>Training Received</b>				
	N/A	Installation	Maintenance	Inspection	Disassembly
Guardrail systems	<input type="checkbox"/>	<input type="checkbox"/>	<input type="checkbox"/>	<input type="checkbox"/>	<input type="checkbox"/>
Personal fall arrest systems	<input type="checkbox"/>	<input type="checkbox"/>	<input type="checkbox"/>	<input type="checkbox"/>	<input type="checkbox"/>
Safety net systems	<input type="checkbox"/>	<input type="checkbox"/>	<input type="checkbox"/>	<input type="checkbox"/>	<input type="checkbox"/>
Controlled-access zones	<input type="checkbox"/>	<input type="checkbox"/>	<input type="checkbox"/>	<input type="checkbox"/>	<input type="checkbox"/>
Covers	<input type="checkbox"/>	<input type="checkbox"/>	<input type="checkbox"/>	<input type="checkbox"/>	<input type="checkbox"/>
Fences and barricades	<input type="checkbox"/>	<input type="checkbox"/>	<input type="checkbox"/>	<input type="checkbox"/>	<input type="checkbox"/>
Warning line systems, fences and barricades	<input type="checkbox"/>	<input type="checkbox"/>	<input type="checkbox"/>	<input type="checkbox"/>	<input type="checkbox"/>
Safety-monitoring systems	<input type="checkbox"/>	<input type="checkbox"/>	<input type="checkbox"/>	<input type="checkbox"/>	<input type="checkbox"/>
<b>Name of worker:</b> _____					



# 5

## Digest of General Industry OSHA Standards Regarding Fall Prevention

### ***Aisles and Passageways***

29 CFR 1910.22(b)(1). Where mechanical handling equipment is used, sufficient safe clearance shall be allowed for aisles at loading docks, through doorways, and whenever turns are made. Aisles and passageways shall be kept clear and in good repair with no obstructions across or in aisles that could create hazards.

29 CFR 1910.22(b)(2). Permanent aisles and passageways shall be appropriately marked.

### ***Dockboards***

29 CFR 1910.30(a)(1). Dockboards shall be strong enough to carry the load imposed on them.

29 CFR 1910.30(a)(2) and (4). Portable dockboards shall be anchored or equipped with devices that will prevent their slipping. They shall have handholds or other effective means to allow safe handling.

29 CFR 1910.30(a)(5). Positive means shall be provided to prevent railroad cars from being moved while dockboards are in position.

### ***Floors, General Condition***

29 CFR 1910.22(a)(2) and (3). All floor surfaces shall be kept clean, dry and free from protruding nails, splinters, loose boards, holes or projections.

29 CFR 1910.22(a)(2). Where wet processes are used, drainage shall be maintained, and false floors, platforms, mats or other dry standing places should be provided where practicable.

### ***Floor Openings, Hatchways, Open Sides***

29 CFR 1910.23(a). Floor openings requiring access by personnel, such as stairway openings and ladderway openings, shall be guarded by a standard railing on all exposed sides except at the access point. Access to ladderway openings shall be further guarded so that a person cannot walk directly into the opening. Other floor openings shall be guarded by a suitable covering and further guarded when the covering is removed by a removable standard railing, or shall be constantly attended by someone. Skylight openings shall be guarded by a standard skylight screen or fixed standard railing on all four sides.

### ***Housekeeping***

29 CFR 1910.22(a)(1). All places of employment, passageways, storerooms and service rooms shall be kept clean and orderly and in a sanitary condition.

### ***Ladders, Fixed***

29 CFR 1910.27(a)(1). All fixed ladders shall be designed for a minimum concentrated live load of 200 pounds.

29 CFR 1910.27(b)(1). All rungs shall have a minimum diameter of  $\frac{3}{4}$  inch, if metal, or if the ladder is constructed of metal rungs embedded in concrete and exposed to a corrosive atmosphere, the rungs shall have a minimum diameter of 1 inch or shall be painted or otherwise treated to prevent corrosion or rusting. Wooden ladders shall have rungs with a minimum diameter of  $1\frac{1}{8}$  inch. All rungs shall be spaced uniformly, not more than 12 inches apart, and shall have a minimum clear length of 16 inches.

29 CFR 1910.27(b)(7). Metal ladders shall be painted or treated to resist corrosion or rusting when the location demands.

29 CFR 1910.27(d)(1) and (2). Cages, wells or ladder safety devices for ladders affixed to towers, watertanks or chimneys shall be provided on all ladders more than 20 feet long. Landing platforms shall be provided each 30 feet of length, except where no cage is provided, landing platforms shall be provided for every 20 feet of length.

29 CFR 1910.27(d)(1). Tops of cages on fixed ladders shall extend 42 inches above top of landing, unless other acceptable protection is provided, and the bottom of the cage shall be not less than 7 feet nor more than 8 feet above the base of the ladder.

29 CFR 1910.27(d)(3). The side rails of through or side-step ladder extensions shall extend 3½ feet above parapets and landings. For through ladder extensions, the rungs shall be omitted from the extension and shall have not less than 18 nor more than 24 inches clearance between rails. For side-step or offset fixed ladder sections, at landings, the side rails and rungs shall be carried to the next regular rung beyond or above the 3½ feet minimum.

## ***Ladders, Portable***

29 CFR 1910.25(c)(2), (3)(ii), (3)(iii), (3)(iv), (3)(v), (4)(ii) and (4)(iii). Portable wood stepladders can be no longer than 20 feet. Stepladders are specified as being of three types: Type I—Industrial stepladder, 3 to 20 feet for heavy duty, such as utilities, contractors and industrial use; Type II—Commercial stepladder, 3 to 12 feet for medium duty, such as painters, offices and light industrial use; Type III—Household stepladder, 3 to 6 feet for light duty, such as light household use. The following denote other ladders and their maximum length: Single straight ladders, 30 feet; two-section extension ladders, 60 feet; sectional ladders, 60 feet; trestle ladders, 20 feet; painter's stepladders, 12 feet; and mason's ladders, 40 feet.

29 CFR 1910.26(a)(2)(ii), (3)(iii), (4)(1) and (5)(1). The maximum length for portable metal ladders shall be: single straight ladders, 30 feet; two-section extension ladders, 48 feet; over two-section extension ladders, 60 feet; stepladders, 20 feet; trestle ladders, 20 feet; and platform stepladders, 20 feet.

29 CFR 1910.25(c)(2)(i)(f) and 29 CFR 1910.26(a)(3)(viii). Stepladders shall be equipped with a metal spreader or locking device of sufficient size and strength to securely hold the front and back sections in open position.

29 CFR 1910.25(d)(1) and 29 CFR 1910.26(c)(2). Ladders shall be maintained in good condition, and defective ladders shall be withdrawn from service.

29 CFR 1910.25(d)(2)(i) and (iii) and 29 CFR 1910.26(c)(3)(i) and (iii). Non-self-supporting ladders shall be erected on a sound base at a 4:1 pitch and placed to prevent slipping.

29 CFR 1910.25(d)(2)(xv). The top of a ladder used to gain access to a roof shall extend at least 3 feet above the point of contact.

## ***Personal Protective Equipment***

29 CFR 1910.132(a). Proper personal protective equipment, including shields and barriers, shall be provided, used and maintained in a sanitary and reliable condition where there is a hazard from processes or environment that may cause injury or illness to the employee.

29 CFR 1910.132(b). Where employees furnish their own personal protective equipment, the employer shall be responsible to assure its adequacy and to ensure that the equipment is properly maintained and in a sanitary condition.

## ***Railings***

29 CFR 1910.23(e)(1). A standard railing shall consist of top rail, intermediate rail and posts and shall have a vertical height of 42 inches nominal from upper surface of top rail to floor, platform or similar surface.

29 CFR 1910.23(c)(1). A railing for open-sided floors, platforms and runways shall have a toeboard whenever beneath the open side persons can pass, there is moving machinery, or there is equipment with which falling materials could cause a hazard.

29 CFR 1910.23(e)(3)(iv). Railings shall be of such construction that the complete structure shall be capable of withstanding a load of at least 200 pounds in any direction on any point on the top rail.



29 CFR 1910.23(e)(2). A stair railing shall be of construction similar to a standard railing, but the vertical height shall be not more than 34 inches nor less than 30 inches from upper surface of top rail to surface of thread in line with face of riser at forward edge of tread.

**Scaffolds**

29 CFR 1910.28(a)(4). Scaffolds and their components shall be capable of supporting without failure at least four times the maximum intended load.

29 CFR 1910.28(a)(9). All planking shall be Scaffold Grade, as recognized by grading rules for the species of wood used. The maximum permissible spans for 2 x 9 inch or wider planks are shown in the following table:

	<b>Material</b>				
	<b>Full thickness-undressed lumber</b>			<b>Nominal thickness lumber</b>	
Working load (p.s.f.)	25	50	75	25	50
Permissible span (ft.)	10	8	6	8	6

The maximum permissible span for 1¼ x 9 inch or wider plank of full thickness is 4 feet with medium loading of 50 p.s.f.

29 CFR 1910.28(a)(13). Scaffold planks shall extend over their end supports not less than 6 inches nor more than 18 inches.

29 CFR 1910.28(a)(11). Scaffold planking shall be overlapped a minimum of 12 inches or secured from movement.

**Stairs, Fixed Industrial**

29 CFR 1910.24(h). Standard railings shall be provided on the open sides of all exposed stairways. Handrails shall be provided on at least one side of closed stairways, preferably on the right side descending.

29 CFR 1910.24(f). Stairs shall be constructed so that rise height and tread width is uniform throughout.

29 CFR 1910.24(d). Fixed stairways shall have a minimum width of 22 inches.

## Digest of Construction Industry OSHA Standards Regarding Fall Prevention

### *Floor Openings, Open Sides, Hatchways*

29 CFR 1926.501(b)(4)(i). Each employee on walking/working surfaces shall be protected from falling through holes (including skylights) more than 6 feet (1.8 m) above lower levels, by personal fall arrest systems, covers or guardrail systems erected around such holes.

29 CFR 1926.501(b)(1). Each employee on a walking/working surface (horizontal and vertical surface) with an unprotected side or edge which is 6 feet (1.8 m) or more above a lower level shall be protected from falling by use of guardrail systems, safety net systems or personal fall arrest systems.

29 CFR 1926.501(b)(6). Each employee on ramps, runways and other walkways shall be protected from falling 6 feet (1.8 m) or more to lower levels by guardrail systems.

### **1926.760, Subpart R-Steel Erection**

#### **Fall protection (a) General requirements.**

(1) Except as provided by paragraph (a)(3) of this section, each employee engaged in a steel erection activity who is on a walking/working surface with an unprotected side or edge more than 15 feet (4.6 m) above a lower level shall be protected from fall hazards by guardrail systems, safety net systems, personal fall arrest systems, positioning device systems or fall restraint systems.

(2) Perimeter safety cables. On multi-story structures, perimeter safety cables shall be installed at the final interior and exterior perimeters of the floors as soon as the metal decking has been installed.

(3) Connectors and employees working in controlled decking zones shall be protected from fall hazards as provided in paragraphs (b) and (c) of this section, respectively.

#### **(b) Connectors.** Each connector shall:

(1) Be protected in accordance with paragraph (a)(1) of this section from fall hazards of more than two stories or 30 feet (9.1 m) above a lower level, whichever is less;

(2) Have completed connector training in accordance with §1926.761; and

(3) Be provided, at heights over 15 and up to 30 feet above a lower level, with a personal fall arrest system, positioning device system or fall restraint system and wear the equipment necessary to be able to be tied off; or be provided with other means of protection from fall hazards in accordance with paragraph (a)(1) of this section.

**(c) Controlled Decking Zone (CDZ).** A controlled decking zone may be established in that area of the structure over 15 and up to 30 feet above a lower level where metal decking is initially being installed and forms the leading edge of a work area. In each CDZ, the following shall apply:

(1) Each employee working at the leading edge in a CDZ shall be protected from fall hazards of more than two stories or 30 feet (9.1 m), whichever is less.

(2) Access to a CDZ shall be limited to only those employees engaged in leading edge work.

(3) The boundaries of a CDZ shall be designated and clearly marked. The CDZ shall not be more than 90 feet (27.4 m) wide and 90 (27.4 m) feet deep from any leading edge. The CDZ shall be marked by the use of control lines or the equivalent. Examples of acceptable procedures for demarcating CDZ's can be found in Appendix D to this subpart.

(4) Each employee working in a CDZ shall have completed CDZ training in accordance with §1926.761.

(5) Unsecured decking in a CDZ shall not exceed 3,000 square feet (914.4 m<sup>2</sup>).

(6) Safety deck attachments shall be performed in the CDZ from the leading edge back to the control line and shall have at least two attachments for each metal decking panel.

(7) Final deck attachments and installation of shear connectors shall not be performed in the CDZ.

**(d) Criteria for fall protection equipment.**

(1) Guardrail systems, safety net systems, personal fall arrest systems, positioning device systems and their components shall conform to the criteria in §1926.502 (see Appendix G to this subpart).

(2) Fall arrest system components shall be used in fall restraint systems and shall conform to the criteria in §1926.502 (see Appendix G). Either body belts or body harnesses shall be used in fall restraint systems.

(3) Perimeter safety cables shall meet the criteria for guardrail systems in §1926.502 (see Appendix G).

**(e) Custody of fall protection.** Fall protection provided by the steel erector shall remain in the area where steel erection activity has been completed, to be used by other trades, only if the controlling contractor or its authorized representative:

(1) Has directed the steel erector to leave the fall protection in place; and

(2) Has inspected and accepted control and responsibility of the fall protection prior to authorizing persons other than steel erectors to work in the area.

### **Housekeeping**

29 CFR 1926.25(a). During the course of construction, alteration or repairs, form and scrap lumber with protruding nails and all other debris shall be kept cleared from work areas, passageways and stairs in and around buildings or other structures.

29 CFR 1926.25(b). Combustible scrap and debris shall be removed at regular intervals.

29 CFR 1926.25(c). Containers shall be provided for collection and separation of all refuse. Covers shall be provided on containers used for flammable or harmful substances. Garbage and other wastes shall be disposed of at frequent intervals.

### **Illumination**

29 CFR 1926.56(a). Construction areas, ramps, runways, corridors, offices, shops and storage areas shall be lighted to not less than the minimum illumination intensities listed in Table D-3 while any work is in progress.

**Table D-3**

**Minimum Illumination Intensities in Footcandles**

<b>Footcandles</b>	<b>Area or Operation</b>
5.....	General construction area lighting
3.....	General construction areas, concrete placement, excavation and waste areas, accessways, active storage areas, loading platforms, refueling, and field maintenance areas
5.....	Indoors: warehouses, corridors, hallways, and exitways
5.....	Tunnels, shafts, and general underground work areas: (Exception: minimum of 10 foot-candles is required at tunnel and shaft heading during drilling, mucking, and scaling. Bureau of Mines approved cap lights shall be acceptable for use in the tunnel heading.)
10.....	General construction plant and shops (e.g., batch plants, screening plants, mechanical and electrical equipment rooms, carpenter shops, rigging lofts and active storerooms, barracks or living quarters, locker or dressing rooms, mess halls, indoor toilets, and workrooms)
30.....	First-aid stations, infirmaries, and offices

## ***Ladders***

29 CFR 1926.1053(b)(16) and (17). The use of ladders with broken or missing rungs or steps, broken or split side rails, or other faulty or defective construction is prohibited. When ladders with such defects are discovered, they shall immediately be withdrawn from service.

29 CFR 1926.1053(b)(5)(i). Non-self-supporting ladders shall be used at an angle such that the horizontal distance from the top support to the foot of the ladder is approximately one-quarter of the working length of the ladder (the distance along the ladder between the foot and the top support).

29 CFR 1926.1053(b)(6) and (9). Ladders shall be used only on stable and level surfaces unless secured to prevent accidental displacement. The area around the top and bottom of ladders shall be kept clear.

29 CFR 1926.1053(b)(12). Ladders shall have nonconductive siderails if they are used where the employee or the ladder could contact exposed energized electrical equipment, except as provided in 1926.951(c)(1) of this part.

29 CFR 1926.1051(a)(2). A double-cleated ladder or two or more separate ladders shall be provided when ladders are the only means of access or exit from a working area for 25 or more employees, or when a ladder is to serve simultaneous two-way traffic.

## ***Personal Protective Equipment***

29 CFR 1926.28(a). The employer is responsible for requiring the wearing of appropriate personal protective equipment in all operations where there is an exposure to hazardous conditions or where the need is indicated for using such equipment to reduce the hazard to the employees.

29 CFR 1926.106(a). Employees working over or near water, where the danger of drowning exists, shall be provided with U.S. Coast Guard–approved life jackets or buoyant work vests.

## ***Railings***

29 CFR 1926.502(b)(1). Top edge height of top rails, or equivalent guardrail system members, shall be 42 inches (1.1 m) plus or minus 3 inches (8 cm) above the walking/working level.

29 CFR 1926.502(b)(2). Midrails, screens, mesh, intermediate vertical members or equivalent intermediate structural members shall be installed between the top edge of the guardrail system and the walking/working surface when there is no wall or parapet wall at least 21 inches (53 cm) high.

29 CFR 1926.1052(c)(3). A stair railing shall be of construction similar to a standard railing. The height of stairrails installed before March 15, 1991, shall be not less than 30 inches (76 cm) nor more than 34 inches (86 cm) from the upper surface of the stairrail system to the surface of the tread. Stairrails installed after March 15, 1991, shall be not less than 36 inches (91.5 cm) from the upper surface of the stairrail system to the surface of the tread.

29 CFR 1926.1052(c)(5). Handrails and the top rails of stairrail systems shall be capable of withstanding, without failure, a force of at least 200 pounds (890 n) applied within 2 inches (5 cm) of the top edge, in any downward or outward direction, at any point along the top edge.

## ***Safety Nets***

29 CFR 1926.105(a). Safety nets shall be provided when workplaces are more than 25 feet above the surface where the use of ladders, scaffolds, catch platforms, temporary floors, safety lines or personal fall arrest system is impractical.

29 CFR 1926.105(b). Where safety net protection is required, operations shall not be undertaken until the net is in place and has been tested.

## ***Scaffolds***

29 CFR 1926.451(g)(2). The employer shall have the competent person determine the feasibility and safety of providing fall protection for employees erecting or dismantling supported scaffolds.

29 CFR 1926.451(c)(2). Supported scaffold poles, legs, posts, frames and uprights shall bear on base plates and mud sills or other adequate firm foundation.

29 CFR 1926.451(a)(1). Scaffolds and their components shall be capable of supporting, without failure, its own weight and at least four times the maximum intended load.

29 CFR 1926.451(g)(1). Each employee on a scaffold more than 10 feet (3.1 m) above a lower level shall be protected from falling to that lower level. Paragraphs (g)(1)(I) through (vii) of this section establish the types of fall protection to be provided to the employees on each type of scaffold.

29 CFR 1926.451(h)(1). In addition to wearing hardhats, each employee on a scaffold shall be provided with additional protection from falling hand tools, debris and other small objects through the installation of toeboards, screens, or guardrail systems, or through the erection of debris nets, catch platforms or canopy structures that contain or deflect the falling objects.

29 CFR 1926.451(b)(4). Each end of a platform, unless cleated or otherwise restrained by hooks or equivalent means, shall extend over the centerline of its support at least 6 inches (15 cm).

29 CFR 1926.451(b)(5)(I). Each end of a platform 10 feet or less in length shall not extend over its support more than 12 inches (30 cm).

29 CFR 1926.451(f)(4). Any part of a scaffold damaged or weakened such that its strength is less than that required shall be immediately repaired or replaced.

29 CFR 1926.451(a)(1). All planking shall be capable of supporting, without failure, its own weight and at least four times the maximum intended load applied or transmitted to it. (Refer to Appendix A.)

### **Material**

	<b>Full thickness- undressed lumber</b>			<b>Nominal thickness lumber</b>	
Working load (p.s.f.)	25	50	75	25	50
Permissible span (ft.)	10	8	6	8	6

The maximum permissible span for 1¼ × 9 inch or wider plank of full thickness is 4 feet, with medium loading of 50 p.s.f.

## ***Stairs***

29 CFR 1926.1052(c)(1). Every flight of stairs having four or more risers or rising more than 30 inches, whichever is less, shall be equipped with at least one handrail and one stairrail system along each unprotected side or edge.

29 CFR 1926.1052(a)(3). Rise height and tread width shall be uniform throughout any flight of stairs, including any foundation structure used as one or more treads of the stairs.

29 CFR 1926.1052(b)(1). Stairs of hollow pan-type treads shall be filled to the level of the nosing with solid materials. The requirements shall not apply during the period of actual construction of the stairways themselves.

## ***Storage***

29 CFR 1926.250(a)(1). All materials stored in tiers shall be secured to prevent sliding, falling or collapse.

29 CFR 1926.250(a)(3). Aisles and passageways shall be kept clear and in good repair.

29 CFR 1926.151(d)(1). Storage of materials shall not obstruct exits.

29 CFR 1926.151(d)(2). Materials shall be stored with due regard to their fire characteristics.

29 CFR 1926.151(c)(3). Weeds and grass in outside storage areas shall be kept down and a regular procedure provided for the periodic cleanup of the entire area.

## ***Toeboards (Floor Openings, Wall Openings and Stairways)***

29 CFR 1926.451(g)(4)(I). Guardrail systems shall be installed along all open sides and ends of platforms. Guardrail systems shall be installed before the scaffold is released for use by employees other than erection/dismantling crews.

29 CFR 1926.451(h)(2)(ii). A toeboard shall be erected along the edge of platforms more than 10 feet (3.1 m) above lower levels for a distance sufficient to protect employees below.

29 CFR 1926.451(h)(1). Erect toeboards, screens or guardrail systems to prevent objects from falling from higher levels.

29 CFR 1926.502(j)(1). Toeboards, when used as falling object protection, shall be erected along the edge of the overhead walking/working surface for a distance sufficient to protect employees below.

29 CFR 1926.502(j)(4) and 29 CFR 1926.451(h)(2)(ii). Where tools, equipment or materials are piled higher than the top edge of a toeboard, paneling or screening shall be erected from the walking/working surface or toeboard to the top of the guardrail system's top rail or midrail, for a distance sufficient to protect employees below.

## ***Falling object protection (Steel Erection)***

29 CFR 1926.759(a) *Securing loose items aloft*. All materials, equipment and tools, which are not in use while aloft, shall be secured against accidental displacement.

29 CFR 1926.759(b) *Protection from falling objects other than materials being hoisted*. The controlling contractor shall bar other construction processes below steel erection unless overhead protection for the employees below is provided.

## ***Walking/Working surfaces:***

State-specific requirements for 1926.754(c)(1)(i), Tripping hazards. Employees shall be protected from falls due to tripping hazards created by shear connectors (including, but not limited to headed steel studs, steel bars or steel lugs), reinforcing bars, deformed anchors, or threaded studs attached to the top flanges of beams, joists or beam attachments. Such protection from falls may be accomplished by any of the following:

- (1) Shear connectors that project vertically or horizontally across the top flange of a member not being welded or applied until the metal decking or other walking/working surface is installed (field-installed shear connectors).
- (2) All employees working on members with shop or pre-installed shear connectors shall be protected from falling hazards greater than 6 feet by suitable, as defined in 1926.32(s), fall protection systems, including guardrail systems, personal fall arrest systems, or safety nets.
- (3) Shop or preinstalled connectors that project vertically from or horizontally across the top flange of the member shall be covered by a temporary decking, metal or wood box until the metal decking, or other suitable walking/working surface, is installed or until final construction covers the shear connectors.

## OSHA Requirements for Guardrails, Safety Harnesses, Safety Nets and Other Protection

Height	Safety Equipment	Requirements	OSHA Standard
Any height	Guardrail or cover	Guardrail or cover shall be provided for open pit, tanks, vat, ditches.	1910.22(c)
Any height	Guardrail	Every temporary floor opening shall have standard railings, or shall be constantly attended by someone.	1910.23(a)(7)
Any height	Guardrail or cover	Every floor hole into which persons can accidentally walk shall be guarded by either a standard railing with standard toeboard on all exposed sides, or a floor hole cover. While the cover is not in place, the floor hole shall be constantly attended by someone or shall be protected by a removable standard railing.	1910.23(a)(8)
Any height	Standard railing	Regardless of height, open-sided floors, walkways, platforms or runways above or adjacent to dangerous equipment, pickling or galvanizing tanks, degreasing unit, and similar hazards shall be guarded with a standard railing and toeboard.	1910.23(c)(3)
Any height	Guardrail, toeboard and metallic mesh or similar material	Guardrail, toeboard and metallic mesh or similar material shall be provided for powered platform for exterior building maintenance.	1910.66(f)(5)(i)(G)
Any height	Personal fall arrest systems	Application of and performance criteria for personal fall arrest systems that are required for use by all employees using powered platforms.	1910.66(j)
Any height	Guardrail, gates, or maze	Guardrail, gates or maze shall be provided at all entrances and exits at floor landing affording access to manlift.	1910.68(b)(8)
Any height	Guardrail	Guardrail handholds and steps shall be provided on cranes for easy access to the car and cab.	13 NCAC 07F .0908
Any height	Guardrail or personal fall arrest system	Employees required to perform duties on the horizontal boom of hammerhead tower cranes shall be protected against falling by guardrails or personal fall arrest system.	13 NCAC 07F .0908
Any height	Guardrail	Walkways shall be provided where employees or equipment are required or permitted to cross over excavations. Guardrails shall be provided where walkways are 6 feet or more above lower levels.	1926.651(l)
Any height	Guardrail	Concrete mixers of one cubic yard capacity or greater shall be equipped with protective guardrails installed on each side of skip.	1926.702(b)(2)
Any height	Guardrail	Any chute opening, into which workmen dump debris, shall be protected by a substantial guardrail.	1926.852(e)
Any height	Safety nets	When employees are engaged in work over or near water and when danger of drowning exists, suitable protection shall be provided.	1926.950(g)
Any height	Body belts with straps or lanyards	Body belts with straps or lanyards shall be worn to protect employees working at elevated locations on poles, towers, or other structures.	1926.951(b)
10' or more	Guardrail	Guardrail systems shall be installed on all open sides and ends of scaffold platforms more than 10 feet above the ground or floor.	1926.451(g)
Any height	Body belt and lanyard	A body belt shall be worn and a lanyard attached to the boom or basket when working from an aerial lift.	1926.453(b)(2)(v) <i>Extensible and articulating boom platforms</i>
10' or more	Guardrail and toeboards	A guardrail and toeboards shall be provided for all manually propelled mobile ladder stands and scaffolds (towers).	1910.29(a)(3)(vi) and (vii)

<b>Height</b>	<b>Safety Equipment</b>	<b>Requirements</b>	<b>OSHA Standard</b>
10' or more	Fall protection	Each employee on a scaffold more than 10 feet above a lower level shall be protected from falling to that lower level. Paragraphs (g)(1)(i) through (vii) of this section establish the types of fall protection to be provided to the employees on each type of scaffold.	1926.451(g)(1)
6' or more	Guardrail or safety belts	Every open-sided floor, platform, and runway 6 feet or more above adjacent floor or ground level shall be protected from falling by the use of guardrail systems, safety net systems, or personal fall arrest systems.	1926.501(b)(1)
25' or more	Safety net	Safety nets shall be provided when workplaces are more than 25 feet above the ground or other surfaces where the use of scaffolds, catch platforms, temporary floor or personal fall arrest systems are impractical.	1926.105(a)
25' or more	Safety net	On buildings or structures not adaptable to temporary floors, and where scaffolds are not used, safety nets shall be installed and maintained whenever the potential fall distance exceeds two stories or 25 feet.	1926.750(b)(ii)



## References

*Oregon Health and Safety Resource*. June 1995. Oregon Occupational Safety and Health Division. Department of Consumer and Business Services.

*Stairways and Ladders*, OSHA 3124. 1997 (Revised). U.S. Department of Labor. Occupational Safety and Health Administration.

*Accident Prevention Manual for Industrial Operations*. 1988. National Safety Council. Administration of Programs. Chicago.

OR-OSHA, Department of Consumer and Business Services: Fall Protection for Residential Type Construction, 2824A (7/2000); Fall Protection for Roofing Work, 2824B (2/2001); Fall Protection in the Construction Industry 2824 (7/2000)

USDOL, OSHA Instruction, Directive Number: CPL 2-1.34 Inspection policy and procedures for OSHA's steel erection standards for construction.

## **OSH Publications**

We provide a variety of OSH publications. These include general industry and construction regulations, industry guides that cover different OSH topics, quick cards, fact sheets and brochures that cover a wide variety of serious safety and health workplace hazards. Workplace labor law posters are available free of charge. To obtain publications, call toll free at 1-800-NC-LABOR (1-800-625-2267) or direct at 919-807-2875. You may view the list of publications and also download many of them at **[www.nclabor.com/pubs.htm](http://www.nclabor.com/pubs.htm)**.