



Online Continuing Education for Professional Engineers  
Since 2009

# Relocating of Structures for Flood Protection

PDH Credits:

**3 PDH**

Course No.:

**RSF101**

Publication Source:

**US FEMA**

**“Relocation”**

*Engineering Principles and Practices  
for Retrofitting Flood-Prone Residential Structures  
Chapter 5R, FEMA P-25  
3rd Edition*

Release Date:

Jan. 2012

**DISCLAIMER:**

All course materials available on this website are not to be construed as a representation or warranty on the part of Online-PDH, or other persons and/or organizations named herein. All course literature is for reference purposes only, and should not be used as a substitute for competent, professional engineering council. Use or application of any information herein, should be done so at the discretion of a licensed professional engineer in that given field of expertise. Any person(s) making use of this information, herein, does so at their own risk and assumes any and all liabilities arising therefrom.



# 5R Relocation

Relocation is the retrofitting measure that can offer the greatest security from future flooding (see Figure 5R-1). It involves moving an entire structure to another location, usually outside the floodplain. Selection of the new site is usually conducted by the homeowner, often in consultation with the designer to ensure that critical site selection factors such as floodplain location, accessibility, utility service, cost, and homeowner preference meet engineering and local regulatory concerns. Relocation as a retrofitting measure not only relieves anxiety about future flooding, but also offers the opportunity to reduce future flood insurance premiums.



Figure 5R-1.  
House relocation (photo  
courtesy of Wolfe House  
Movers)

The relocation process, as illustrated in Figure 5R-2, is fairly straightforward. There are, however, a number of design considerations to be addressed before embarking on this retrofitting measure. The nine steps involved with the relocation of a structure are discussed in more detail throughout this chapter.

**Figure 5R-2.**  
Relocation process

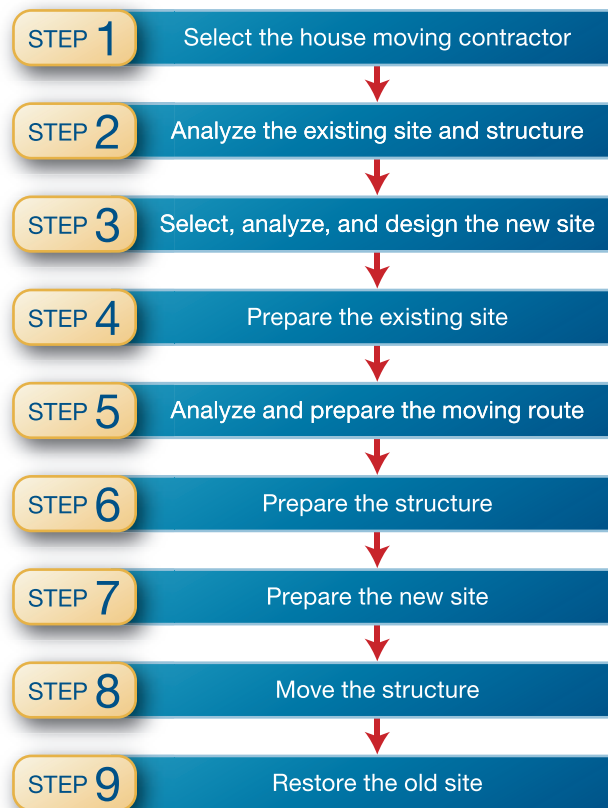

## 5R.1 Step 1: Select the House Moving Contractor

The selection of a moving contractor is one of the most important decisions a homeowner will make and may ultimately have the greatest impact on the success of the project. The designer can assist the homeowner in selecting an experienced home moving contractor. Some of the key elements of this selection (outlined in Figure 5R-3) include:

**Experience:** The homeowner and designer should visit recent projects the contractor has completed and talk to owners who recently went through the process to develop an opinion on the quality of work done.

**Financial Stability:** The homeowner/designer should determine whether and to what extent the contractor is licensed, insured, and bonded. A prudent homeowner will consider the potential risk of a failed project before enlisting the assistance of a contractor.

**Professionalism and Reputation:** The designer/homeowner may wish to check the contractor's reputation with the State licensing board, the local Better Business Bureau, local officials, and/or the International Association of Structural Movers (IASM). A critical question is whether or not the contractor is licensed to work in your area.



The designer/homeowner should also interview several contractors to determine:

- how well they may be able to work with this contractor;
- the extent of the contractor’s knowledge; and
- what confidence may be had in the contractor’s ability to complete the relocation project.

**NOTE**

The International Association of Structural Movers may be contacted at: P.O. Box 1213, Elbridge, NY 13060, (315) 689-9498, or <http://www.iasm.org> to obtain information on house relocation companies for a retrofitting project.

**Cost of Services:** While this should not be the sole determinant of contractor selection, cost of services is an important aspect of the relocation process. To ensure a comparison of similar levels of effort, the designer/homeowner should develop a detailed scope of services to be provided and have each contractor prepare a bid from the same scope of services. Remember, the most qualified contractor may not always have the highest cost and, conversely, the least qualified contractor may not have the lowest cost.

Relocation Contractor Selection Checklist			
<b>1. Experience of the Contractor:</b>			
Recent, successful house re-elevation projects?	Yes _____	No _____	
Satisfied clients providing good references?	Yes _____	No _____	
Met time schedules?	Yes _____	No _____	
Cleaned up and restored old site?	Yes _____	No _____	
Quality product through your visual inspection of recent projects?	Yes _____	No _____	
<b>2. Financial Stability of Contractor:</b>			
Bonded?	Yes _____	No _____	Amounts _____
Licensed?	Yes _____	No _____	Amounts _____
Insured?	Yes _____	No _____	Amounts _____
<b>3. Professionalism and Reputation of Contractor:</b>			
State Licensing Agency: _____			
Better Business Bureau: _____			
Local Officials: _____			
International Association of Structural Movers: _____			
Results of the Interview: _____			
<b>4. Cost of Services:</b> _____			
<b>5. Summary of References:</b> _____			

Figure 5R-3. Relocation contractor selection checklist

## 5R.2 Step 2: Analyze the Existing Site and Structure

The designer should help the homeowner to ensure that the contractor conducts an analysis of the existing site and structure to determine the critical criteria for the relocation of the structure. These criteria will include:

- Is there sufficient space around the structure for the installation of lifting beams and truck wheels?
- Can the structure be lifted as one piece or must it be separated into sections?
- Depending on the final assessment of the structure's conditions, how much bracing will be required to successfully move this structure?
- Will this structure survive the lift and a move of the distance proposed by the homeowner?
- Which utilities must be disconnected and where?
- What local regulations govern demolition of the remaining portions of the structure (foundation and paved areas) and to what standard must the site be restored?



### WARNING

Usually the analysis of the existing site and structure is conducted by the moving contractor and not by the homeowner's designer. However, it is important that the designer/homeowner coordinate and communicate with the contractor regarding the issues related to the analysis of the existing site and structure for relocation.

The contractor usually has experience in analyzing the existing structure to determine:

- the size and placement of lifting beams, jacks, and lateral or cross beams; and
- whether the structure should be elevated and moved in one piece or elevated and moved several pieces.

The final decision on these items may not be made until an evaluation of the moving route is conducted, as the moving route can present other factors the contractor must consider (see Step 5).

**Lifting Beam Placement:** Each of the following factors affecting the placement of lifting beams must be considered during the elevation and relocation process:

- size and shape of the house;
- existing framing and parameters;
- deflection limitations; and
- distribution of the house's weight.



### WARNING

If the selected contractor is not familiar with factors regarding lifting beam placement, the homeowner and designer might reconsider their contractor selection.

The major consideration for the placement of lifting beams is to limit cracking due to excessive deflections during preparation, moving, and settling in place. The lifting beams, in tandem with cross or lateral beams, must sufficiently support the structure. When the house is removed from the foundation, the lifting and lateral beams should provide as stable a support as the original foundation.

Deflection of any portion of the structure is normally a result of the manner in which the weight of the house is distributed, the location of the jacks under the lifting beams, and the rigidity of the lifting beam. Proper placement of lifting beams, jacks, and lateral beams will protect against cracking of both the interior and exterior finishes, as well as ensure the integrity of the entire house.

A second consideration concerning the installation of lifting beams is to ensure that they are located so that the house can be attached to truck wheel sets forming a trailer.

The route to be taken during the relocation of the house dictates the physical size and weight limitations of the structure, due to the horizontal and vertical clearances from obstructions. The house may have to be cut into sections which are moved separately to negotiate the available route. Lifting beams, therefore, would have to be placed for each section to be moved. The entire elevation framing must also be rigid enough to take the forces associated with physical movement of the house.

Heavier construction materials on certain portions of the house, such as brick veneer, chimneys, and fireplaces, causes additional deflection and warrants special attention when determining the lifting beam system. Even with minimal deflection, brick construction is subject to cracking. Therefore, extra precautions, in the form of additional beam support or removal of the brick for possible later replacement, will be needed.

The size and shape of the house also affects the placement and number of lifting beams. A simple rectangular floor plan allows for the easiest and most straightforward type of elevation project. Generally, placement of the longitudinal lifting beams, with lateral beams located as required, is the system utilized for the elevation process. Larger or more complex shapes, such as L-shaped or multi-level houses, necessitate additional lifting beams and jacks to provide a stable lifting support system. Every consideration of the load based upon the size and shape of the house should be incorporated into the design and layout of the lifting beam system.

### 5R.3 Step 3: Select, Analyze, and Design the New Site

The selection of a new site for a relocated house will require the examination of potential sites with regard to:

- floodplain location;
- utility extension feasibility;
- accessibility; and
- permitting feasibility.

The process is similar to selecting a lot upon which to design and build a new house. Local building codes and approval processes must be followed. In some instances, the homeowner may be required to upgrade existing mechanical, electrical, and plumbing systems to meet current code requirements.

**Site Access:** An important consideration in the selection of a new site is the accessibility of the site for both the house movers and the new site construction crews. Severe site access constraints can increase the cost of the retrofit measures. Constraints can also require cleaning and grading activities, which may diminish the site characteristics initially desired by the homeowner.



#### NOTE

Information on site design standards may be obtained from the local building official, or, if there is none, from the HUD's publication ACCN-6212, Proposed Model Land Development Standards and Accompanying State Enabling Legislation (HUD,1993)..



**Permits:** The designer/homeowner should make certain that, when the house is moved to the new lot, it will conform to all the zoning and construction standards in effect at the time of relocation. The designer should contact the local regulatory officials to determine the design standards and submission process requirements that govern development of a new site. All permits required for construction at the new site and for transporting the house to the new site should be obtained prior to initiating the relocation process.

### 5R.4 Step 4: Prepare the Existing Site

Initial preparation of the site includes clearing all vegetation from the area in and around the footprint of the house (see Figure 5R-4). This is done to clear a path beneath the house to allow the insertion of beams for lifting supports. These pathways should be deep enough to allow for the movement of both people and machinery.

Figure 5R-4.  
Clearing pathways  
beneath the structure for  
lifting supports (photo  
courtesy of Wolfe House  
Movers)



### 5R.5 Step 5: Analyze and Prepare the Moving Route

Once the relocation site has been selected, a route for transport must be analyzed and selected. This route should be carefully chosen and planned well in advance of the design of the new site or the undertaking of any relocation process activities at the existing site.

**Identify Route Hazards:** Make certain that the house, as it will be moved, will be able to navigate the following:

- narrow passages, such as road cuts and widths;
- bridge weight limits and widths;

- utility conflicts, such as light poles, and electric and telephone lines;
- fire hydrants;
- road signs;
- steep grades;
- traffic signals; and
- tight turns around buildings, bridges, and overpasses.



### WARNING

Timing may be critical in areas that have heavy traffic during morning and evening rush hours. Houses are often relocated during the late evening and early morning hours.

Care should be taken to ensure that the structure will clear all overhead utility lines. Many of these can be lifted during the move, but utility companies sometimes require the presence of their employees and will charge for this service. In some instances, an overland (non-road) route may be the best alternative.

**Obtain Approvals:** It may be necessary to obtain moving permits, not only for the area from which the structure is being moved, but also in jurisdictions through which the structure is passing. Approvals for transport in a public right-of-way may be required from local governments, highway departments, and utility companies. Often approvals may be necessary from private landowners whose properties are either crossed or affected by the move.

The time required to obtain approvals and the complexity of information some parties may require in order to provide approvals may vary widely. The designer/contractor and homeowner should investigate this approval process early in the relocation effort to minimize potential delays due to obtaining permits.

**Coordinate Route Preparation:** The moving contractor should be responsible for the necessary coordination made along the moving route. This includes:

- the raising or relocation of utilities by utility companies;
- any road/highway modifications, such as traffic lights, signage, temporary bridges, etc.; and
- clearing/grubbing of overland areas, where necessary.

The moving contractor should also be responsible for making sure that these facilities are returned to their normal operating condition as soon as the move is completed.

## 5R.6 Step 6: Prepare the Structure

The steps involved in preparing a structure to be moved are described below.

**Disconnect Utilities:** The first step in preparing the structure is to disconnect all the utilities connected to the structure. Specific requirements governing the capping, abandoning, and/or removal of specific utilities should be available from the local utility companies and/or the local regulatory officials.

**Cut Holes in Foundation Wall for Beams:** From beneath the structure, the pathways for lifting beams are cut into the existing foundation (see Figure 5R-5).



Figure 5R-5.  
Pathways for lifting  
beams (photo courtesy of  
Wolfe House Movers)



**Install Beams:** Lifting and lateral beams are placed beneath the structure at all critical lift points and support cribbing is added as the structure is separated from its old foundation (see Figure 5R-6).

Figure 5R-6.  
Beams supported by  
cribbing are placed at  
critical lift points (photo  
courtesy of Wolfe House  
Movers)



**Install Jacks:** Jacks are used to lift the structure from its foundation (see Figure 5R-7). Various types of jacking systems may be employed as long as gradual and uniform lifting pressures are utilized to lift the structure.



Figure 5R-7.  
Hydraulic jacks installed  
to lift structure from  
foundation (photo  
courtesy of Wolfe House  
Movers)

**Install Bracing as Required:** Bracing may need to be installed to maintain the integrity of the structure.

**Separate Structure from Foundation:** The structure now stands free from its former foundation (see Figure 5R-8).



Figure 5R-8.  
Structure is separated  
from its foundation  
(photo courtesy of Wolfe  
House Movers)



## 5R.7 Step 7: Prepare the New Site

The new site is prepared for the arrival of the structure.

**Design Foundation:** The steps needed to design the new foundation have been defined in Chapter 5E.

**Design Utilities:** Utilities must be available to be brought directly to the structure at the new site. Construction should be accomplished in accordance with the approved set of design documents prepared for the new site and any building permit conditions specified by local officials (as explained in Step 3).

**Excavation and Preparation of New Foundation:** At the new site, excavation and preparation of the foundation are underway (see Figure 5R-9).

**Construction of Support Cribbing:** Support cribbing is put in place to allow the structure to be jacked up and the truck wheel sets are removed. With support cribbing in place, materials for completion of the foundation are readied.

**Construction of Foundation Walls:** The foundation wall construction begins (see Figure 5R-10).

Figure 5R-9.  
Foundation preparation at  
new site (photo courtesy  
of Wolfe House Movers)





Figure 5R-10.  
New foundation wall  
construction begins  
(photo courtesy of Wolfe  
House Movers)

## 5R.8 Step 8: Move the Structure

Once the structure has been raised, it is transported to the new site. This process is outlined below.

**Excavate/Grade Temporary Roadway:** Excavation and grading of a temporary roadway is done at one end of the structure. The truck wheels, which will form the trailer that will be used to move the house, are brought to the site and placed beneath the lifting and lateral beams (see Figure 5R-11).



Figure 5R-11.  
Trailer wheel sets are  
placed beneath the lifting  
beams (photo courtesy of  
Wolfe House Movers)



**Attach Structure to Trailer:** The house is attached to the truck wheels and then attached to the tractor/bulldozer in preparation for the moving of the structure from its original site (see Figure 5R-12). The tractor/bulldozer is used to pull the house to street level, while workers continually block the wheels to prevent sudden movement. At street level, the house is stabilized and a truck is connected to the trailer for the journey to the new site.

**Transport Structure to New Site:** With connections to the truck completed, the actual transport of the structure to the new site begins.

**Lower Structure onto Foundation:** Once the desired height of the new wall is reached, the house is lowered onto its new foundation, cribbing is removed, and foundation walls are completed (see Figure 5R-13).

Figure 5R-12.  
Trailer is used to pull the house to the street (photo courtesy of Wolfe House Movers)



Figure 5R-13.  
House is lowered and connected to the foundation after foundation walls are completed (photo courtesy of Wolfe House Movers)





**Landscaping:** Finishing touches, like preparing the foundation for backfilling and landscaping, are done to blend in the house with its new environment.

## 5R.9 Step 9: Restore the Old Site

Once the structure is removed from the site, certain steps need to be taken to stabilize the site in accordance with local regulations. Many homeowners have sold or deeded these abandoned properties to local municipalities for the development of parkland and/or open space. In any case, permits for the demolition of the old site, remaining foundation, and remaining utility systems, as well as grading and site vegetative stabilization are normally required.

**Demolish and Remove Foundation and Pavement:** The old basement may have to be backfilled to eliminate any potential hazards. Check local regulations to see if old foundation and utility connections have to be removed.

**Disconnect and Remove All Utilities:** Following up on the disconnection and capping of utility services previously discussed in Step 6, the homeowner may be required to remove all existing utility systems from the site. Septic tanks and oil/gas storage tanks on site may be governed by specific environmental guidelines, which must be followed to ensure that leakage to groundwater sources does not occur. Depending upon the age and condition of the tanks, the homeowner may be required to drain and remove these tanks, or drain and stabilize the underground tanks against flotation.

The homeowner may also be required to test the soil around an underground tank to determine if leakage has occurred. If leakage is confirmed, the homeowner is usually responsible for cleaning the contaminated soils. When facing this situation, the homeowner should contact a qualified geotechnical or environmental engineer. Specific requirements governing the capping, abandoning, and/or removal of specific utilities should be determined from the local utility companies and/or the local regulatory officials.



### NOTE

Material from drained septic, oil, and gas storage tanks must be disposed of in a safe and legal manner.

**Grading and Site Stabilization:** The old site may have to be regraded after all the excavation and movement by the heavy equipment. The lot will need to be stabilized with vegetation as appropriate to its intended future use.



# 6 Case Studies

This chapter presents case studies based on structural and nonstructural retrofitting measures. The studies illustrate many of the procedures presented in the previous chapters and actual design practices. The cases include scenarios that examine elevation, relocation, dry and wet floodproofing, and small floodwalls and levees.

The case studies that follow are fictionalized scenarios developed to illustrate the retrofit option selection and design process. Narratives, graphics, photos, and calculations are fabricated and not based on actual individuals or structures.

## 6.1 Case Study #1: Residential Retrofit in Riverine Floodplain Using Elevation or Relocation

This case study examines the retrofit of a residential building in a riverine floodplain by means of elevation or relocation. Details are provided in the subsections that follow.

### 6.1.1 Description of Property

Harry S. Truman  
55555 Cedar River Road, Mount Vernon, IA 55555

The Truman family has owned a large plot of land near Mount Vernon, Iowa, since the early 20<sup>th</sup> century. The 200+ acre plot slopes up from the Cedar River to a hilly, wooded area. Their current home, a one-story, wood-frame structure, was built in the 1960s, and is considered pre-FIRM construction. It has experienced varying levels of flooding from the Cedar River since its construction. A sunroom addition was built onto

the back of the structures in the 1980s. The structure is located in the SFHA (100-year floodplain) but, due to the sloping nature of the site, most of the rest of the plot is located outside the SFHA.

Harry Truman, the current owner, has decided that he would like to retrofit his home to resist flood damage. The local floodplain ordinance does not allow elevation on fill, and he does not like the idea of an open foundation. Mr. Truman indicated he would like to pursue retrofitting options that would allow him to obtain a reduced NFIP flood insurance rate. If possible, Mr. Truman would like to apply for HMA grant assistance.

### 6.1.2 Structure Information

55555 Cedar River Road is a one-story, wood-frame structure on a crawlspace and is a structure of good quality (Figure 6-1).

Other structure information includes:

- Footprint: 1,800 square feet
- Foundation:
  - Perimeter crawlspace foundation walls are reinforced and grouted CMU block, 8 inches thick, supported by a 2-foot wide x 1-foot thick reinforced concrete wall footer
  - Twelve interior piers at 10-foot spacing are reinforced and grouted double-stack CMU block, supported by 2-foot x 2-foot x 1-foot footer
  - Perimeter foundation walls and interior piers extend 2 feet below grade to the top of the footers, and 2 feet above grade
  - There are no flood vents in the above-grade portion of the perimeter foundation walls
- Structure:
  - First floor elevation of 694.2 feet (reference NAVD88), measured at the top of the lowest finished floor
  - Top of crawlspace of 692.2 feet (reference NAVD88)
  - Wood-frame structure
  - Wood siding
  - Wood-frame interior walls with gypsum board sheathing
- Roof:
  - Gable roof without overhangs over main structure (40 foot x 40 foot plan area)
  - Flat roof without overhangs over sunroom (10 foot x 20 foot area)
  - Asphalt shingle roof covering over entire roof
- Interior:
  - Wood stud interior walls with gypsum board sheathing
  - Hardwood floors

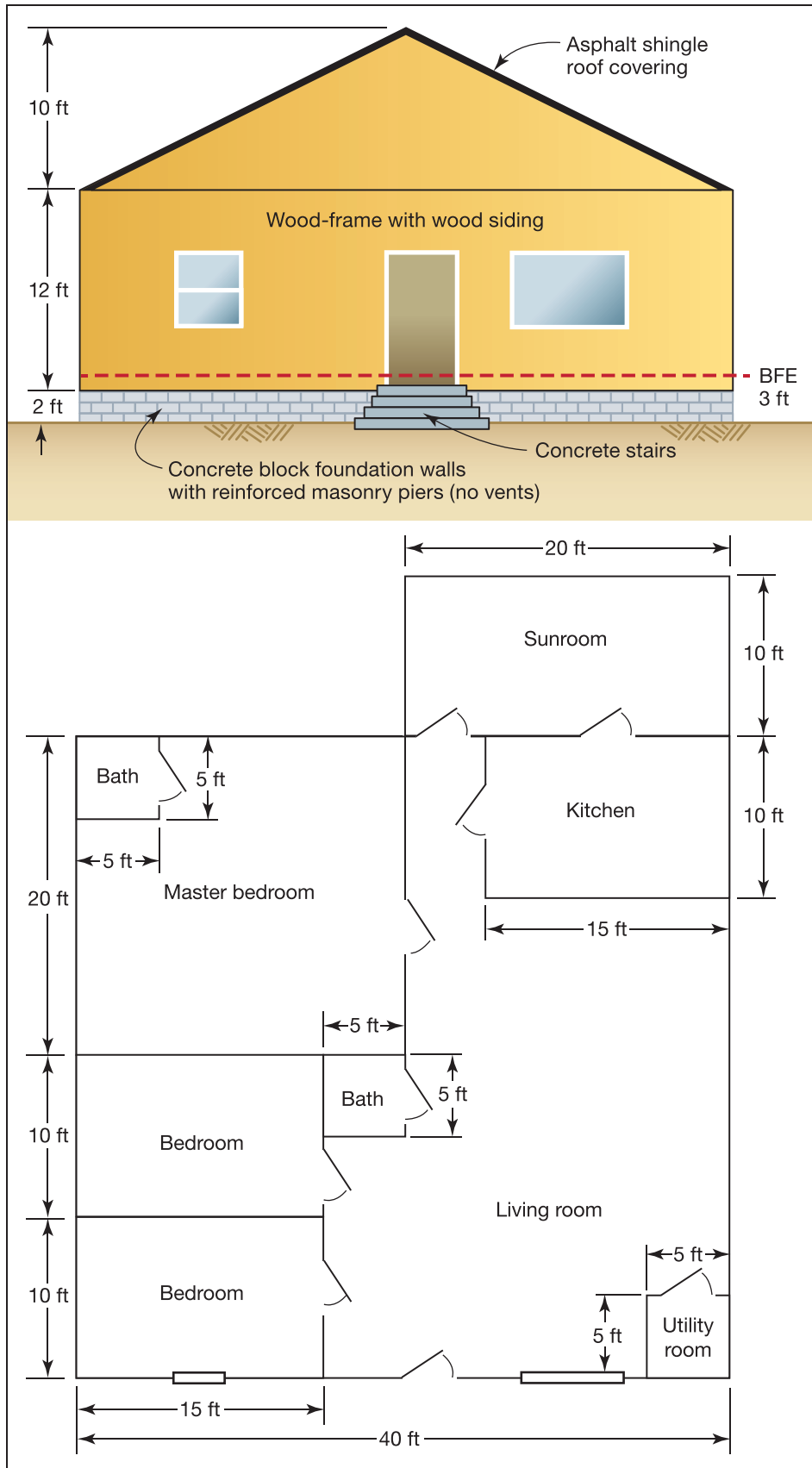

Figure 6-1.  
The Truman house

**Plot**

The 200+ acre plot slopes from an elevation of approximately 690 feet near the river to near 730 feet in the woods. The 10-foot contour map shows the approximate size and topography of the plot and is included at the end of this case study. The site soils are primarily a mixture of silty sand and gravel (Soil Type SM).

**Building Assessment**

An updated tax card is included at the end of this case study as an alternate source of the building replacement value as well as to verify the building square footage data.

Additionally, an engineer’s estimate is that the Truman home has a building replacement value of approximately \$105.00 per square foot, based on popular cost estimating guides.

**Flood Hazard Data**

The local floodplain management ordinance applies to all structures in the floodplain. Elevation on fill is prohibited, and a 1-foot freeboard is required for all new construction and substantial improvements.

The structure itself sits at the low point of the property and is in the SFHA, although most of the plot is outside of the regulatory floodplain. The flood map (FIRMette) is included at the end of this case study.

The applicable excerpts from the FIS show the flood elevations and discharges for the existing structure and are included in Section 6.1.5 and summarized in Table 6-1.

**Table 6-1. Summary of Flood Elevations and Discharges for the Truman House**

	Streambed	10-year	50-year	100-year	500-year
Elevation (ft)	671.2	694	696.3	697.8	700
Discharge (cfs)	NA	53,500	77,900	87,900	112,900

cfs = cubic feet per second

Note: All topographic maps and flood hazard data reference NAVD88.

A licensed surveyor filled out the elevation certificate, which references NAVD88 and is included at the end of this case study.









Note that since there are no flood vents, the top of the lowest floor is considered to be the top of the crawlspace floor. In this case, the top of the crawlspace floor is equivalent to the LAG.

The flow velocity under base flood conditions is assumed to be 2.0 ft/sec.

**6.1.3 Retrofit Options Selection**

During an initial interview with Mr. Truman, potential retrofit options were discussed (Figure 6-2). Immediately, elevation on fill was ruled out because it is prohibited by the local floodplain ordinance. Similarly, dry floodproofing, wet floodproofing, and floodwalls and small levees were ruled out because these measures will not bring a pre-FIRM home located in a SFHA into compliance with the NFIP. Therefore, elevation and relocation are viable options for the structure and will reduce NFIP flood insurance rates.



Owner Name: <u>Harry S. Truman</u>		Prepared By: <u>Jane Q. Engineer</u>							
Address: <u>55555 Cedar River Road</u>		Date: <u>9/1/2011</u>							
Property Location: <u>Mount Vernon, Iowa</u>									
Floodproofing Measures									
Considerations									
	Elevation on Foundation Walls	Elevation on Fill	Elevation on Piers	Elevation on Posts and Columns	Elevation on Piles	Relocation	Dry Flood-proofing	Wet Flood-proofing	Floodwalls and Levees
Measure Allowed or Owner Requirement		X					X	X	X
Homeowner Concerns									
Aesthetic Concerns			X	X	X				
High Cost Concerns	X		X	X	X	X			
Risk Concerns									
Accessibility Concerns	X		X	X	X				
Code Required Upgrade Concerns									
Off-Site Flooding Concerns									
Total "X's"	2	NA	3	3	3	1	NA	NA	NA

Instructions: Determine whether a floodproofing measure is allowed under local regulations or homeowner requirement. Put an "x" in the box for each measure that is not allowed. Complete the matrix for only those measures that are allowable (no "x" in the first row). For those measures allowable or owner required, evaluate the considerations to determine if the homeowner has concerns that would affect its implementation. A concern is defined as a homeowner issue that, if unresolved, would make the retrofitting method(s) infeasible. If the homeowner has a concern, place an "x" in the box under the appropriate measure/consideration. Total the number of "x's". The floodproofing measure with the least number of "x's" is the most preferred.

Figure 6-2. Preliminary Floodproofing/Retrofitting Preference Matrix for the Truman house

Cost was a concern for all potential retrofit options. Mr. Truman was also concerned about building accessibility for an elevation project. Mr. Truman was particularly concerned about how his home might look with an open foundation.

Based on the retrofit option screening matrix, the two most viable options were elevation by extending the foundation walls and relocation. Calculations and considerations are provided for both relocation and elevation.

### Relocation

The only way to completely eliminate the flood risk to Mr. Truman's home is to move the entire structure out of the SFHA. Because his plot is so large, and ample buildable space exists outside of the SFHA, relocation is a good option to consider. Refer to Table 1-2 of this document for the advantages and disadvantages of relocation. The relocation process would include:

- selecting the new structure site;
- designing, excavating for, and constructing the new foundation;
- installing new utility connections at the new site;
- disconnecting utilities at the existing site;
- lifting the existing structure on hydraulic jacks;
- transporting the structure from the original site to the new site;
- lowering the structure and securing it onto the new foundation ;
- connecting utilities; and
- demolishing and filling the old foundation.

Note-Relocation is more likely to be found to be a cost-beneficial option when the owner has a suitable relocation site on the same tract of land. Purchase of a site is avoided and contact with public rights of way and utilities are minimized or avoided.

A preliminary cost estimate shows that the cost of relocation would likely be approximately \$120,000. A preliminary BCA shows a BCR of 1.18. Therefore, relocation would be cost-beneficial as well as effective at eliminating future flood damage.

### Elevation by Extending the Perimeter Foundation Walls

Elevating the structure on the existing perimeter foundation walls is also a viable retrofit option. Refer to Table 1-1 of this document for the advantages and disadvantages of elevation. The elevation process would include:

- designing the extended foundation;
- disconnecting utilities;
- lifting the existing structure on hydraulic jacks;
- extending the foundation walls;

- installing flood vents;
- lowering the structure;
- reconnecting utilities; and
- constructing a new deck and stairs.

The BFE is 697.8 feet NAVD88, and the first floor elevation (i.e., the top of the lowest floor) is 694.2 feet. The elevation of the LAG is 692.2 feet. The BFE is at a depth of  $697.8 \text{ feet} - 692.2 \text{ feet} = 5.6 \text{ feet}$ . Therefore, the floodproofing depth  $H = 5.6 \text{ feet} + 1 \text{ feet} = 6.6 \text{ feet}$ .

Installing NFIP-compliant flood vents in the foundation walls will ensure that the crawlspace is no longer considered the “lowest floor” and that the lowest floor elevation will actually be the top of the floor of the living area. Because the crawlspace is already 2 feet high, the perimeter walls would only need to be extended an additional 4.6 feet to place the first floor elevation 1 foot above the BFE (i.e., 6.6 feet above the LAG).

A preliminary cost estimate shows a retrofit cost of approximately \$100,000. This cost yields a BCR of 1.08. Therefore, elevation would be effective and cost-beneficial.

The elevated structure would look as shown in Figure 6-3. A hydrostatic force computation worksheet is presented in Figure 6-4.

Note that the concrete staircase has been replaced with wooden stairs that allow water to flow through the base.

To ensure that the foundation is properly designed, the flood forces must be calculated and checked with applicable design loads.

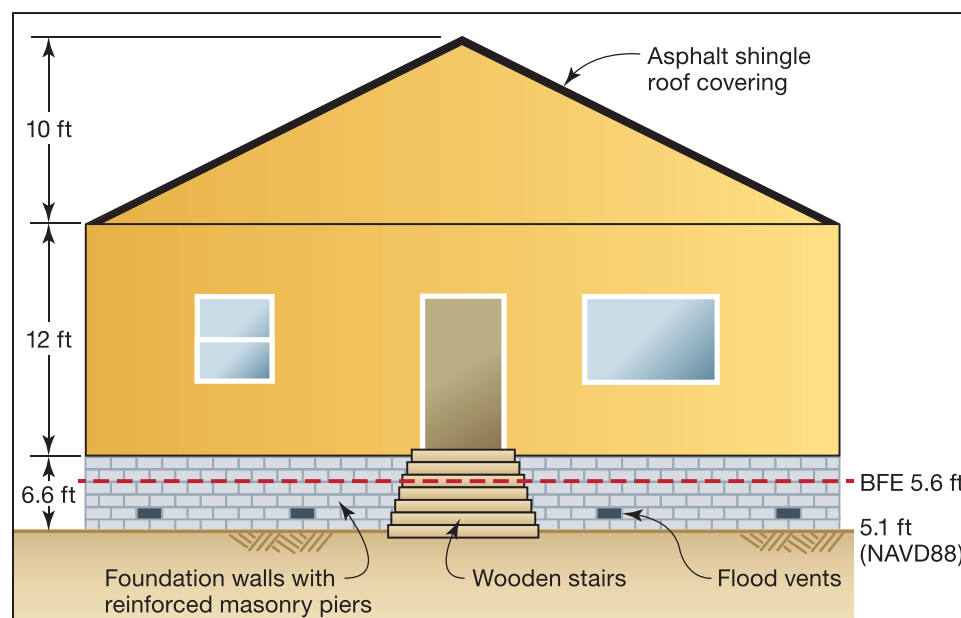

**Figure 6-3.**  
The Truman house after elevation, including extended foundation walls and flood vents

Hydrostatic Force Computation Worksheet			
Owner Name:	Harry S. Truman	Prepared By:	Jane Q. Engineer
Address:	55555 Cedar River Road	Date:	9/1/2011
Property Location:	Mount Vernon, Iowa		
<b>Constants</b>		<b>Summary of Loads</b>	
$\gamma_w$ = specific weight of water = 62.4 lb/ft <sup>3</sup> for fresh water and 64.0 lb/ft <sup>3</sup> for saltwater		$f_{sta}$ = 0 lb/ft	
<b>Variables</b>		$f_{dif}$ = 0 lb/ft	
$H$ = floodproofing design depth (ft) = 6.6 ft		$f_{comb}$ = 0 lb/ft	
$D$ = depth of saturated soil (ft) = 2 ft		$F_{bouy}$ = 135,236 lb	
$S$ = equivalent fluid weight of saturated soil (lb/ft <sup>3</sup> ) = NA			
$Vol$ = volume of floodwater displaced by a submerged object (ft <sup>3</sup> ) = 2,167 ft <sup>3,a</sup>			
<b>Equation 4-4: Lateral Hydrostatic Force</b>			
$f_{sta} = \frac{1}{2}P_b H = \frac{1}{2}\gamma_w H^2 = 0 \text{ lb/ft}$			
<b>Equation 4-5: Submerged Soil and Water Force</b>			
$f_{dif} = \frac{1}{2}(S - \gamma_w)D^2 = 0 \text{ lb/ft}$			
<b>Equation 4-6: Combined Lateral Hydrostatic Force</b>			
$f_{comb} = f_{sta} + f_{dif} = 0 \text{ lb/ft}$			
<b>Equation 4-7: Buoyancy Force</b>			
$F_{bouy} = \gamma_w (Vol) = (62.4 \text{ lb/ft}^3)(2,167 \text{ ft}^3) = 135,236 \text{ lbs}$			

<sup>a</sup> Volume of water displaced is equal to the volume of the foundation walls, footers, floor system, and interior piers:

Walls: Perimeter = 40 ft + 40 ft + 40 ft + 10 ft + 20 ft + 10 ft + 20 ft = 180 ft; height = 4 ft (above grade) + 2 ft (below grade) = 6 ft; thickness = 16 in = 1.33 ft; 6 corners subtract 6(1.33 ft)(1.33 ft)(6 ft) = 63.7 ft<sup>3</sup>; vents: 1 in<sup>2</sup> of open area for 1 ft<sup>2</sup> of enclosed area 1800 in<sup>2</sup> of open area 12.5 ft<sup>2</sup> of open area subtract 1.33 ft \* 12.5 ft<sup>2</sup> = 16.6 ft<sup>3</sup>

$$V_{walls} = (180 \text{ ft})(6 \text{ ft})(1.33 \text{ ft}) - 6(1.33 \text{ ft})(1.33 \text{ ft})(6 \text{ ft}) - (12.5 \text{ ft}^2)(1.33 \text{ ft}) = 1,355.7 \text{ ft}^3$$

Footers: Perimeter = 180 ft; width = 2 ft; thickness = 1 ft; corners subtract 6(2 ft)(2 ft)(1 ft) = 24 ft<sup>3</sup>

$$V_{footers} = (180 \text{ ft})(2 \text{ ft})(1 \text{ ft}) - 6(2 \text{ ft})(2 \text{ ft})(1 \text{ ft}) = 336 \text{ ft}^3$$

Floor: The floor joists and subfloor must be included in Zone A because the top of the lowest floor is at 4 ft. 2 in. x 10 in. floor joists at 16 in. o.c (40 ft x 12 in./ft)/16 in. ≈ 30 joists in main structure. Volume of one joist in main structure = 2 in. x (ft/12 in.) x 10 in. x (ft/12 in.) x 40 ft = 5.56 ft<sup>3</sup>. In sunroom, (20 ft x 12 in./ft)/16 in. = 15 joists. Volume of one joist in sunroom = 2 in. x (ft/12 in.) x 10 in. x (ft/12 in.) x 10 ft = 1.39 ft<sup>3</sup>. Total volume of joists = 30 x 5.56 ft<sup>3</sup> + 15 x 1.39 ft<sup>3</sup> = 187.65 ft<sup>3</sup>. Subfloor 0.5 in. plus 0.25 in. hardwood floor volume of floor = (0.5 in. + 0.25 in.) x (1 ft/12 in.) x 1800 ft<sup>2</sup> = 112.5 ft<sup>3</sup>

$$V_{slab} = 187.65 \text{ ft}^3 + 112.5 \text{ ft}^3 = 300.15 \text{ ft}^3$$

Interior Piers: 12 piers. Each 16 in<sup>2</sup>, 6 ft tall with a 2 ft x 2 ft x 1 ft footer.

$$V_{piers} = 12(1.33 \text{ ft})(1.33 \text{ ft})(6 \text{ ft}) + 12(2 \text{ ft})(2 \text{ ft})(1 \text{ ft}) = 175.4 \text{ ft}^3$$

$$V_{water} = V_{walls} + V_{footers} + V_{slab} + V_{piers} = 1,355.7 \text{ ft}^3 + 336 \text{ ft}^3 + 300.15 \text{ ft}^3 + 175.4 \text{ ft}^3 = 2,167 \text{ ft}^3$$

Figure 6-4. Hydrostatic Force Computation Worksheet for the elevated Truman house (refer to Figure 4-9)

### 6.1.4 Load Calculations

The following paragraphs provide calculations for flood loads, dead loads, live loads, and load combinations, as well as bearing capacity, sliding, uplift, and overturning checks associated with the elevation option.

#### Load Calculations: Flood Loads

The first step is to calculate hydrostatic forces. As determined above, the floodproofing depth  $H$  is 4 feet. The perimeter wall extends 2 feet underground and is supported by a 1-foot-deep footer; therefore, the saturated soil depth  $D$  (measured from the ground surface to the top of the footer) is 2 feet (see Figure 4-8). Because openings were installed in the crawlspace, there are no hydrostatic forces.

The flow velocity is 2.0 ft/sec. An equivalent hydrostatic force computation worksheet is presented in Figure 6-5.

Equivalent Hydrostatic Force Computation Worksheet	
Owner Name: <u>Harry S. Truman</u>	Prepared By: <u>Jane Q. Engineer</u>
Address: <u>55555 Cedar River Road</u>	Date: <u>9/1/2011</u>
Property Location: <u>Mount Vernon, Iowa</u>	
<b>Constants</b>	<b>Summary of Loads</b>
$\gamma_w$ = specific weight of water = 62.4 lb/ft <sup>3</sup> for fresh water and 64.0 lb/ft <sup>3</sup> for saltwater	$f_{db}$ = 40.0 lb/ft
$g$ = acceleration of gravity = 32.2 ft/sec <sup>2</sup>	$f_{sta}$ = 0 lb/ft
<b>Variables</b>	$f_{dif}$ = 0 lb/ft
$H$ = design floodproof depth (ft) = 6.6 ft	$f_{comb}$ = 19.38 lb/ft
$V$ = velocity of floodwater (10 ft/sec or less) = 2 ft/sec	
$P_{db}$ = hydrostatic pressure due to low velocity flood flows = (lb/ft <sup>2</sup> )	
$b$ = width of structure perpendicular to flow (ft) = 40 ft	
Equation 4-8: Conversion of Low Velocity Flood Flow to Equivalent Head	
$dh = \frac{C_d V^2}{2g} = (1.25)(2 \text{ ft/sec})^2 / (2)(32.2 \text{ ft/sec}^2) = 0.0776 \text{ ft}$ Develop $C_d$ : $b/H = 40 \text{ ft} / 4 \text{ ft} = 10$ From Table 4-5; $C_d = 1.25$	
Equation 4-9: Conversion of Equivalent Head to Equivalent Hydrostatic Force	
$f_{db} = \gamma_w (dh)H = P_{db}H = (62.4 \text{ lb/ft}^3)(0.0776 \text{ ft})(6.6 \text{ ft}) = 40.0 \text{ lb/ft}$	
Equation 4-10: Combined Lateral Hydrostatic Force	
$f_{comb} = f_{sta} + f_{dif} + f_{db} = 0 \text{ lb/ft} + 0 \text{ lb/ft} + 40.0 \text{ lb/ft}$	

Figure 6-5. Equivalent Hydrostatic Force Computation Worksheet for the Truman house (refer to Figure 4-11)



The design flood depth is 4 feet; therefore,  $C_D = 0.75$ .  $C_B = 1.0$ . An impact force computation worksheet is presented in Figure 6-6.

Impact Force Computation Worksheet			
Owner Name: _____	Harry S. Truman	Prepared By: _____	Jane Q. Engineer
Address: _____	55555 Cedar River Road	Date: _____	9/1/2011
Property Location: _____	Mount Vernon, Iowa		
<b>Variables</b>		<b>Summary of Loads</b>	
$W$ = weight of the object (lb) = 1,000 lbs		$F_i$ = 1,200 lbs	
$V$ = velocity of water (ft/sec) = 2 ft/sec			
$C_D$ = depth coefficient (see Table 4-6) = 0.75			
$C_B$ = blockage coefficient (taken as 1.0 for no upstream screening, flow path greater than 30 feet; see Table 4-7 for more information)			
$C_{Str}$ = building structure coefficient			
= 0.2 for timber pile and masonry column supported structures 3 stories or less in height above grade			
= 0.4 for concrete pile or concrete or steel moment resisting frames 3 stories or less in height above grade			
= 0.8 for reinforced concrete foundation walls (including insulated concrete forms)			
<b>Equation 4-13: Normal Impact Loads</b>			
$F_i = W V C_D C_B C_{Str} = (1000 \text{ lbs})(2 \text{ ft/sec})(0.75)(1)(0.8) = 1,200 \text{ lbs}$			

Figure 6-6. Impact Force Computation Worksheet for the Truman house (refer to Figure 4-12)

Flood Force Summary:

*Horizontal Force:*

$$f_{comb} = 40.0 \text{ lb/lf}$$

$$F_i = 1,200 \text{ lbs}$$

The total flood force acting on the front wall (perpendicular to flow) is:

$$F = (40.0 \text{ lb/lf})(40 \text{ ft}) + 1,200 \text{ lbs} = 2,800 \text{ lbs}$$

*Vertical Force:*

$$F_{buoy} = 135,236 \text{ lbs}$$

### Load Calculations: Dead Loads

The dead load is the self-weight of the structure. Table 6-2 illustrates the dead load calculations using the conservative unit weights listed in Chapter 4 as well as a less conservative approach.

Table 6-2. Summary of Dead Load Calculations for the Truman House

Element	Area (ft <sup>2</sup> )	Chapter 4 Unit Weight (lb/ft <sup>2</sup> )	Chapter 4 Total Weight (lbs)
Exterior walls: drywall, 4 in. batt insulation, wood siding	$(4)(40 \text{ ft})(12 \text{ ft}) + (2)(10 \text{ ft})(12 \text{ ft}) = 2,160$	11	23,760
Interior walls: wood stud, 2 ft x 4 ft, ½ in. drywall	$(12)(5+5+20+20+15+10+10+5+5+10+15+10) = 1,560$	8	12,480
Floor frame: wood frame, 2 ft x 10 ft interior, unfinished floor	1,800	10	18,000
Floor cover: hardwood	1,800	3	5,400
Ceiling: drywall	1,800	10	18,000
Roof: sloping timbers, sheathing, 10 in. batt insulation	$(2)(40)(102 + 202)1/2 + (10)(20) = 1,992^a$	15	29,880
Roof cover: asphalt shingles	1,992	4	7,968
<b>TOTAL</b>	<b>Over the 1,800 ft<sup>2</sup> structure</b>	<b>61</b>	<b>115,488</b>

<sup>a</sup> Roof area is taken to be the area of the sloping sections of the roof, calculated as twice the area of one side of the roof. Each side of the roof is taken to be rectangular, with dimensions of 40 ft (along the base) and  $[(10)^2 + (20)^2]^{1/2} = 22.4$  ft (the hypotenuse of the triangle formed by the vertical section of the roof structure).

<sup>b</sup> Foundation walls are considered to be a single layer, reinforced CMU wall (8-in. thick) with a unit weight of 75 lb/ft<sup>2</sup>. Walls after mitigation extend 4 ft above ground and 2 ft below ground. The area is therefore  $[4(40 \text{ ft})(6 \text{ ft})] - [4(0.67 \text{ ft})(6 \text{ ft})]$  (to account for corners) = 944 ft<sup>2</sup>.

<sup>c</sup> Foundation piers are considered to be double stack, reinforced CMU piers (16 in. x 16 in.). The unit weight of a 16-in. thick pier is taken to be twice the unit weight of an 8-in. thick reinforced CMU pier. The area is therefore  $12(1.333 \text{ ft})(6 \text{ ft}) = 96 \text{ ft}^2$ .

<sup>d</sup> Unit weights for reinforced concrete are given in lb/ft<sup>3</sup>. The footing volume is taken to be  $[4(40 \text{ ft})(2 \text{ ft})(1 \text{ ft})] - [4(2 \text{ ft})(1 \text{ ft})(1 \text{ ft})] = 312 \text{ ft}^3$ .

<sup>e</sup> See (d). The interior footing volume is taken to be  $12(2 \text{ ft})(2 \text{ ft})(1 \text{ ft}) = 48 \text{ ft}^3$ .

### Load Calculations: Live Loads

#### Live Load (Vertical)

Per ASCE 7-10, assume a live load of:

$$L = 40 \text{ lb/ft}^2 \times (1,800 \text{ ft}^2) = 72,000 \text{ lbs}$$

#### Roof Live Load (Vertical)

Per ASCE 7-10, assume a roof live load of 20 lb/ft<sup>2</sup>. The roof live load acts on the horizontal projected area of the roof:

$$L_r = 20 \text{ lb/ft}^2 \times (1,800 \text{ ft}^2) = 36,000 \text{ lbs}$$

#### Snow Load (Vertical)

Assume a conservative snow load of 20 lb/ft<sup>2</sup>, per ASCE 7-10. The snow load also acts on the horizontal projected area of the roof.

$$S = 20 \text{ lb/ft}^2 (1,800 \text{ ft}^2) = 36,000 \text{ lbs}$$

*Wind Load (Horizontal)*

Appendix C contains a detailed discussion of wind load calculations, including a detailed example. Refer to Appendix C for wind load calculations; this case study uses a simplified approach. Using a simplified wind load, assuming that the structure is fully enclosed, assume a worst case scenario wind load acting perpendicular to the structure (i.e., on the entire face of the structure facing the river). Because the roof at the front (windward side) of the house is sloped and there are no overhangs, there is no vertical wind (uplift) component. Therefore, assume a wind pressure of 30 lb/ft<sup>2</sup> acting uniformly over the entire aboveground structure:

$$\begin{aligned} \text{Area} &= \text{Elevated Crawlspace area} + \text{Exterior Wall area} + \text{Vertical Roof area} \\ \Rightarrow A &= (4 \text{ ft})(40 \text{ ft}) + (12 \text{ ft})(40 \text{ ft}) + (10 \text{ ft})(40 \text{ ft}) = 160 \text{ ft}^2 + 480 \text{ ft}^2 + 400 \text{ ft}^2 = 1040 \text{ ft}^2 \\ W &= 30 \text{ lb/ft}^2 \times (1,040 \text{ ft}^2) = 31,200 \text{ lbs} \end{aligned}$$

*Earthquake Load*

Earthquake forces are assumed to be negligible for this location. Therefore,  $E = 0$ .

**Load Combinations**

To determine the worst-case horizontal and vertical loading scenarios, ASCE 7-10 load combinations are used (Allowable Stress Design). Table 6-3 presents a summary of the horizontal and vertical load combinations.

Load Summary:

*Horizontal Loads*

$$\begin{aligned} D &= L = L_r = S = E = 0 \\ F_a &= F_{comb} = 2,800 \text{ lbs} \\ W &= 31,200 \text{ lbs} \end{aligned}$$

**Table 6-3. Summary of Horizontal and Vertical Load Combinations for the Truman House**

Combination	Horizontal (lbs)	Vertical (lbs)
1. $D$	0	115,560
2. $D + L$	0	187,560
3. $D + (L_r \text{ or } S \text{ or } R)$	0	151,560
4. $D + 0.75L + 0.75(L_r \text{ or } S \text{ or } R)$	0	196,560
5. $D + (0.6W \text{ or } 0.7E) + 0.75F_a$	20,820	14,133
6a. $D + 0.75L + 0.75(0.6W) + 0.75(L_r \text{ or } S \text{ or } R) + 0.75F_a$	16,140	95,133
6b. $D + 0.75L + 0.75(0.7E) + 0.75S + 0.75F_a$	2,100	95,133
7. $0.6D + 0.6W + 0.75F_a$	20,820	-32,091
8. $0.6D + 0.7E$	0	69,336

*Vertical Loads*

$$D = 115,560 \text{ lbs}$$

$$L = 72,000 \text{ lbs}$$

$$L_r = 36,000 \text{ lbs}$$

$$S = 36,000 \text{ lbs}$$

$$W = 0 \text{ (conservative)}$$

$$E = 0$$

$$F_a = F_{buoy} = 135,236 \text{ lbs}$$

**Bearing Capacity Check**

$$P_{max} = A_{bearing} S_{bc}$$

$$S_{bc} = 2,500 \text{ lb/ft}^2 \text{ (Table 5-2)}$$

The bearing area is the area of the footings:

$$A_{bearing} = [4 (40 \text{ ft})(2 \text{ ft})] - [4 (2 \text{ ft})(2 \text{ ft})] + [12(2 \text{ ft})(2 \text{ ft})] = 352 \text{ ft}^2$$

$$P_{max} = (2,500 \text{ lb/ft}^2)(352 \text{ ft}^2) = 880,000 \text{ lbs}$$

Maximum vertical load:

$$335,688 \text{ lbs} < P_{max} \checkmark$$

**Sliding Check**

The soil type is SM; from IBC 2009 (Table 1806.2), the coefficient of friction is 0.25. Worst case horizontal load combination 7:  $0.6D + 0.6W + 0.75F_a$

Horizontal Resistive Force = Foundation Resistive Force + Resistive Force from Structure Self-Weight

Foundation Resistive Force  $r = (k_p)(\gamma_{soil})(d^2/2)$ , where:

$$k_p = \tan^2(45^\circ + \phi/2), \text{ where } \phi \text{ is the soil angle of internal friction (assume } \phi = 30^\circ)$$

$$k_p = \tan^2(45^\circ + 30^\circ/2) = 3$$

$$\gamma_{soil} = 77 \text{ lb/ft}^3 \text{ (Soil Type SM; see Table 4-3)}$$

$$d = \text{depth of soil from top of soil to top of footer} = 2 \text{ ft}$$

$$\text{Therefore, } r = (3)(77 \text{ lb/ft}^3)(2 \text{ ft})^2/2 = 462 \text{ lb/ft}$$

Assume both side walls of the main structure resist sliding, therefore,

$$R_H = 2(40 \text{ ft})(462 \text{ lb/ft}) = 36,960 \text{ lbs}$$

$$\text{Resistive Force from Structure Self Weight} = 0.25 (0.6D) = 0.25 \times 0.6 (115,560 \text{ lbs}) = 17,334 \text{ lbs}$$

$$\text{Total Resistive Force} = 36,960 \text{ lbs} + 17,334 \text{ lbs} = 54,294 \text{ lbs}$$

$$\text{Horizontal Load} = 0.6W + 0.75F_a = 20,820 \text{ lbs} < 38,203 \text{ lbs} \checkmark$$

Figure 6-7 presents the moment diagram for the Truman house.

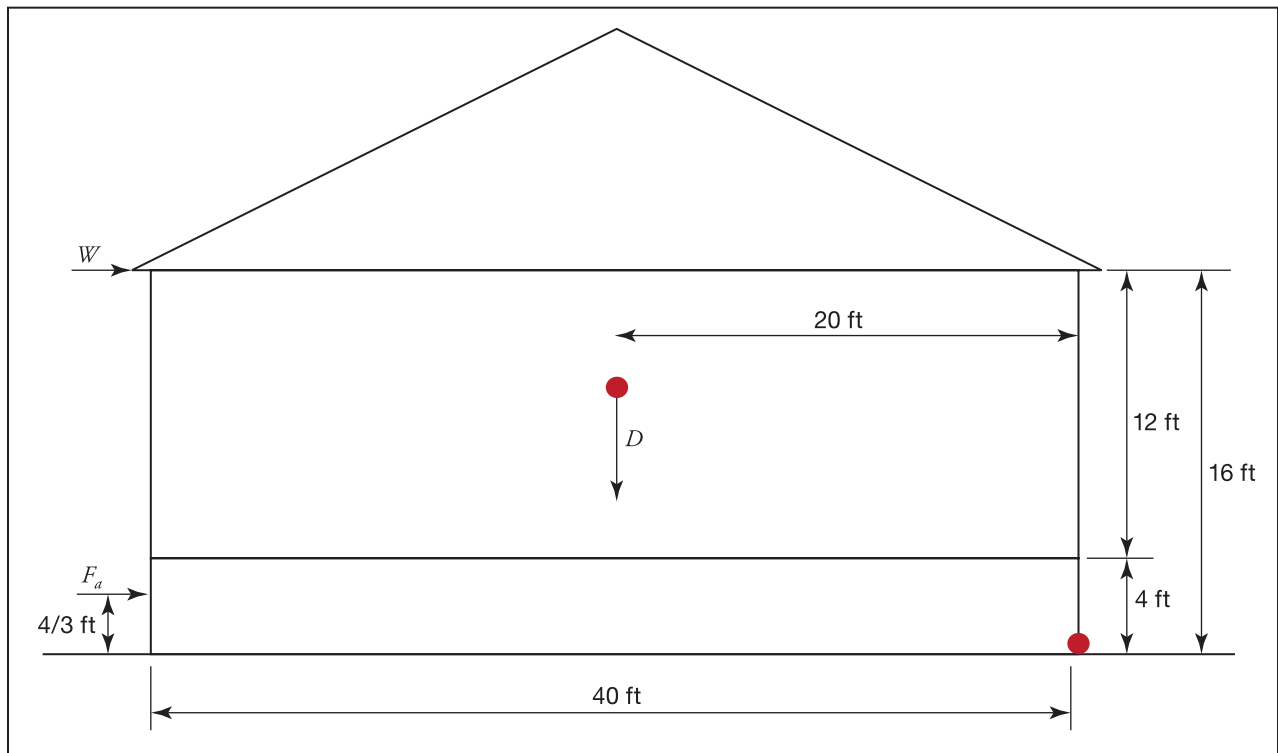

Figure 6-7. Moment diagram for the Truman house

**Uplift Check**

The worst case load combination for the uplift check would be  $0.6D + 0.6W + 0.75F_a$ .

The resistive force is equal to the weight of the concrete footer and soil above the footer that would need to be uprooted. Assuming a soil angle of internal friction of  $\phi = 30^\circ$ , a cross section of the displaced soil and footer is as follows in Figure 6-8:

Figure 6-8. Cross section of displaced soil and footer

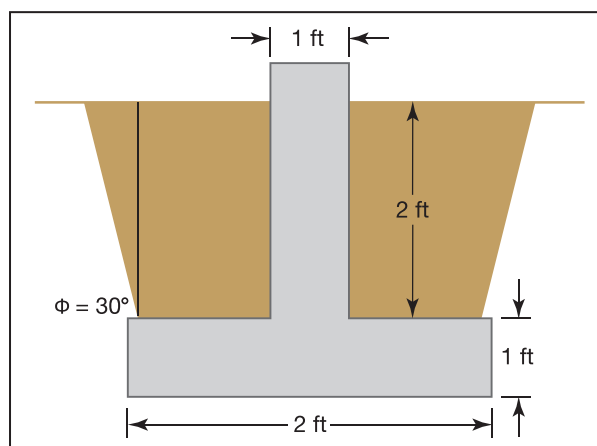

To calculate the weight of the displaced concrete and soil, calculate the volume displaced. The perimeter of the house is given by  $(40 \text{ ft} \times 3 + 20 \text{ ft} + 10 \text{ ft} + 20 \text{ ft} + 10 \text{ ft}) = 180 \text{ ft}$ .

The volume of the foundation walls is given by:

$$V_{walls} = (180 \text{ ft} \times 2 \text{ ft} \times 1 \text{ ft}) - 6(2 \text{ ft} \times 1 \text{ ft}) = 348 \text{ ft}^3$$

The volume of the footers is given by:

$$V_{footer} = (180 \text{ ft} \times 1 \text{ ft} \times 2 \text{ ft}) - 6(1 \text{ ft} \times 2 \text{ ft}) = 348 \text{ ft}^3$$

The total volume of concrete is:  $V_{concrete} = 348 \text{ ft}^3 + 348 \text{ ft}^3 = 696 \text{ ft}^3$

The total weight of concrete is:  $W_{concrete} = 150 \text{ lb/ft}^3 \times 696 \text{ ft}^3 = 104,400 \text{ lbs}$

The cross-section of the displaced soil is given by the area of the trapezoid of soil failure minus the area of the wall. The smaller base of the trapezoid is 2 feet. The angle of internal friction is  $30^\circ$ , therefore the wider base of the trapezoid is  $2 \text{ feet} + 2[2\tan(30^\circ)] = 4.3 \text{ feet}$ . Therefore the cross-sectional area of the displaced soil is:

$$A_{soil} = (2 \text{ ft} + 4.3 \text{ ft}) \times 2 \text{ ft} / 2 - 2 \text{ ft} \times 1 \text{ ft} = 4.3 \text{ ft}^2$$

The volume of displaced soil is given by:

$$V_{soil} = (180 \text{ ft} \times 4.3 \text{ ft}^2) - 6(4.3 \text{ ft}^2) = 748.2 \text{ ft}^3$$

The total weight of soil is:  $W_{soil} = 77 \text{ lb/ft}^3 \times 748.2 \text{ ft}^3$ .

Therefore, the total resistive force is:  $R_v = 104,400 \text{ lbs} + 57,611 \text{ lbs} = 162,011 \text{ lbs}$

Vertical uplift =  $0.6W + 0.75F_a = 101,427 \text{ lbs} < 162,011 \text{ lbs} \checkmark$

### Overturning Check

$$M_W = (16 \text{ ft})W = 499,200 \text{ ft-lbs}$$

$$M_F = -(20 \text{ ft})F_V + -(4/3 \text{ ft})F_H = -2,708,453 \text{ ft-lbs}$$

$$0.6M_W + 0.75M_F = (0.6)(+499,200 \text{ ft-lbs}) + (0.75)(-2,708,453) = -1,731,820 \text{ ft-lbs}$$

$$M_D = (20 \text{ ft})D = 2,311,200 \text{ ft-lbs}$$

$$0.6M_D = 1,386,720 \text{ ft-lbs}$$

$$M_{Rv} = (20 \text{ ft})R_v = 3,240,220 \text{ ft-lbs}$$

$$0.6M_W + 0.75M_F < 0.6M_D + M_{Rv} \checkmark$$

## 6.1.5 Supporting Documentation

This section includes additional information about the Truman house. The following maps and documents provide backup documentation for the values used in the Case Study 1 calculations, including:

- topographic map showing the location of the plot and ground elevation (Figure 6-9);
- FIRMette showing the location of the plot relative to the SFHA (Figure 6-10);
- summary of discharges, excerpted from the FIS, showing the 10-, 50-, 100-, and 500-year discharges at the Truman house (Figure 6-11);
- flood profile showing the 10-, 50-, 100-, and 50-year flood elevations at the Truman house (Figure 6-12);

- elevation certificate showing the first floor elevation (Figure 6-13);
- tax card providing building value and square footage (Figure 6-14); and
- BCA report excerpt summarizing the cost-effectiveness of elevation and relocation (Figure 6-15).



Figure 6-9. Topographic map showing the location of the Truman plot (in red). Please note these are 10-foot contours.



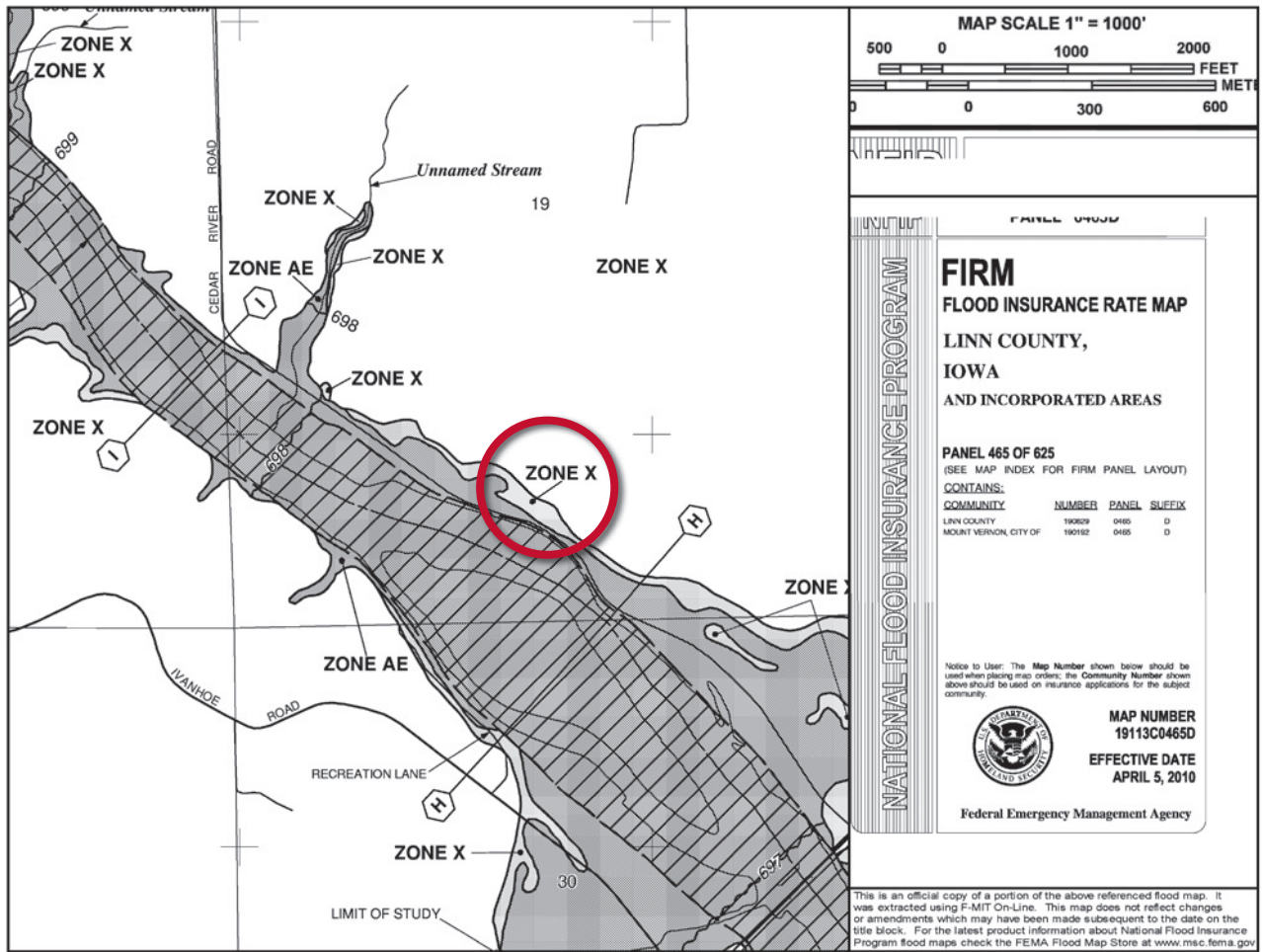

Figure 6-10. FIRM showing the location of the Truman plot (circled in red)

**TABLE 3 – SUMMARY OF DISCHARGES**

<u>Flooding Source and Location</u>	<u>Drainage Area Sq. Miles</u>	<u>Peak Discharges (CFS)</u>			
		<u>10% Annual Chance</u>	<u>2% Annual Chance</u>	<u>1% Annual Chance</u>	<u>0.2% Annual Chance</u>
<b>CEDAR CREEK</b>					
At south county boundary	6987	52800	70000	88000	112000
At State Highway 1 bridge	6974	53500	77900	87900	112900
Just upstream of confluence of Big Creek	6847	52200	77700	87700	112700
Just upstream of confluence of Morgan Creek	6458	53500	78100	88100	113100
At the gaging station in Cedar Rapids at 7 <sup>th</sup> Avenue SW	6510	53000	77000	87000	112000
Just upstream of confluence of Otter Creek	6381	53700	78400	88400	113400
Just upstream of confluence of Opossum Creek	6243	53800	78500	88600	113600
<b>WAPSIPINICON RIVER</b>					
At south county boundary	1324	18350	30520	36000	49220
Just above confluence of Heatons Creek	1294	18090	30080	35480	48500
Just above confluence of Waltons Creek	1242	17810	29620	34940	47760
<b>MARTINS CREEK</b>					
At mouth	4.2	1255	2485	3152	4995
Just upstream of small tributary in the northwest quarter of Section 14, T83N, R6W	3.5	1225	2410	3055	4830
Just upstream of small tributary in the northwest quarter of Section 11, T83N, R6W	2.2	1010	2010	2565	4105

Figure 6-11. FIS Excerpt: Discharge table for the Truman house (applicable discharges circled in red)

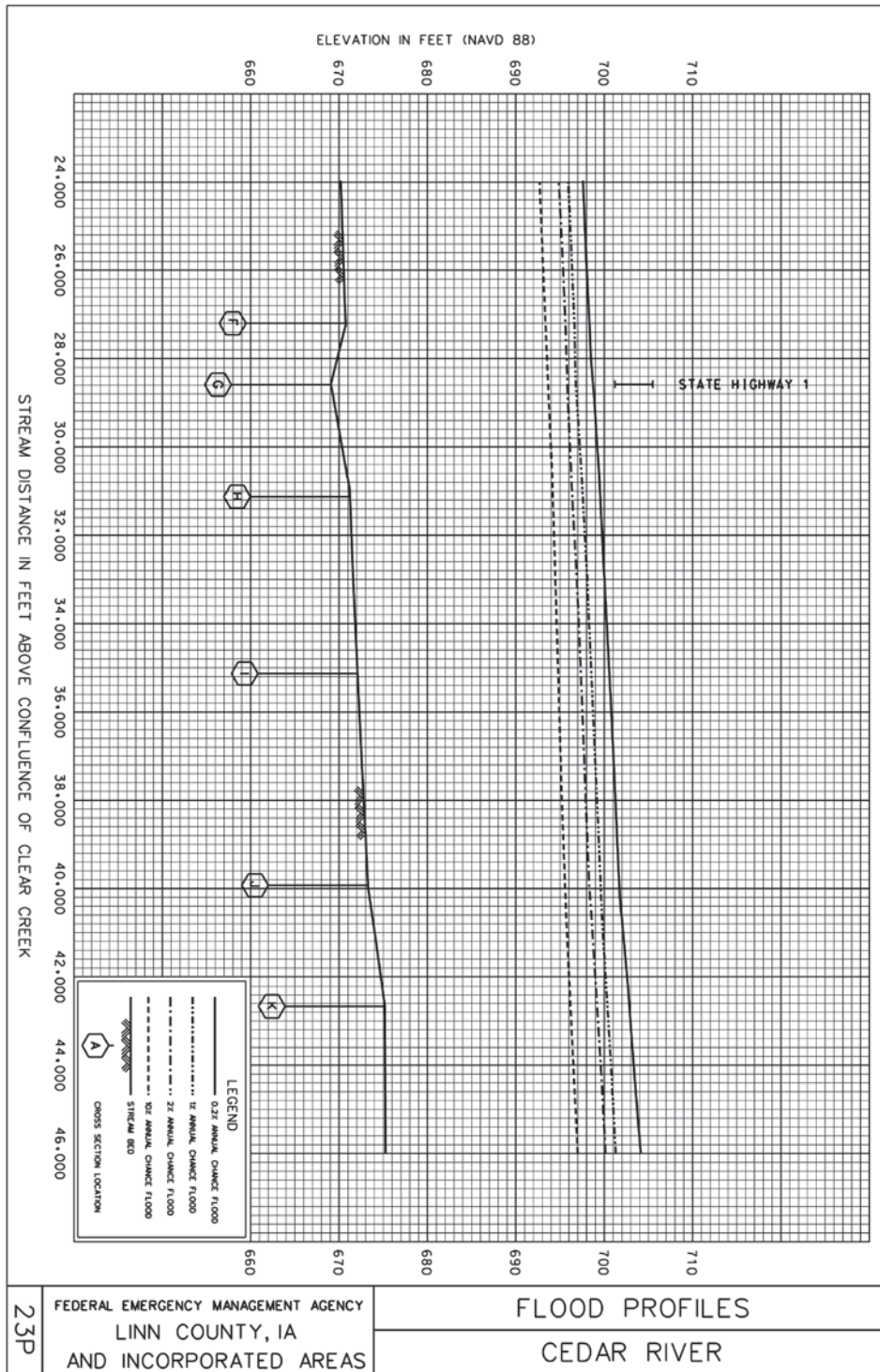

Figure 6-12.  
FIS excerpt: Flood profile  
for the Truman house

U.S. DEPARTMENT OF HOMELAND SECURITY  
Federal Emergency Management Agency  
National Flood Insurance Program

## ELEVATION CERTIFICATE

Important: Read the instructions on pages 1-9.

OMB No. 1660-0008  
Expires March 31, 2012

---

**SECTION A - PROPERTY INFORMATION**

A1. Building Owner's Name Samuel Klayman

A2. Building Street Address (including Apt., Unit, Suite, and/or Bldg. No.) or P.O. Route and Box No.  
55555 Cedar River Road  
City Mount Vernon State IA ZIP Code 55555

A3. Property Description (Lot and Block Numbers, Tax Parcel Number, Legal Description, etc.)  
NA

A4. Building Use (e.g., Residential, Non-Residential, Addition, Accessory, etc.) Residential

A5. Latitude/Longitude: Lat. NA Long. NA Horizontal Datum:  NAD 1927  NAD 1983

A6. Attach at least 2 photographs of the building if the Certificate is being used to obtain flood insurance.

A7. Building Diagram Number 8

A8. For a building with a crawlspace or enclosure(s):  
 a) Square footage of crawlspace or enclosure(s) 1800 sq ft  
 b) No. of permanent flood openings in the crawlspace or enclosure(s) within 1.0 foot above adjacent grade 0  
 c) Total net area of flood openings in A8.b 0 sq in  
 d) Engineered flood openings?  Yes  No

A9. For a building with an attached garage:  
 a) Square footage of attached garage \_\_\_\_\_ sq ft  
 b) No. of permanent flood openings in the attached garage within 1.0 foot above adjacent grade \_\_\_\_\_  
 c) Total net area of flood openings in A9.b \_\_\_\_\_ sq in  
 d) Engineered flood openings?  Yes  No

For Insurance Company Use:

Policy Number \_\_\_\_\_

Company NAIC Number \_\_\_\_\_

---

**SECTION B - FLOOD INSURANCE RATE MAP (FIRM) INFORMATION**

B1. NFIP Community Name & Community Number <u>19113C</u>		B2. County Name <u>Linn County</u>		B3. State <u>IA</u>	
B4. Map/Panel Number <u>465</u>	B5. Suffix <u>D</u>	B6. FIRM Index Date <u>April 5, 2010</u>	B7. FIRM Panel Effective/Revised Date <u>April 5, 2010</u>	B8. Flood Zone(s) <u>AE</u>	B9. Base Flood Elevation(s) (Zone AO, use base flood depth) <u>697.8</u>

B10. Indicate the source of the Base Flood Elevation (BFE) data or base flood depth entered in Item B9.  
 FIS Profile  FIRM  Community Determined  Other (Describe) \_\_\_\_\_

B11. Indicate elevation datum used for BFE in Item B9:  NGVD 1929  NAVD 1988  Other (Describe) \_\_\_\_\_

B12. Is the building located in a Coastal Barrier Resources System (CBRS) area or Otherwise Protected Area (OPA)?  Yes  No  
 Designation Date \_\_\_\_\_  CBRS  OPA

---

**SECTION C - BUILDING ELEVATION INFORMATION (SURVEY REQUIRED)**

C1. Building elevations are based on:  Construction Drawings\*  Building Under Construction\*  Finished Construction  
 \*A new Elevation Certificate will be required when construction of the building is complete.

C2. Elevations – Zones A1-A30, AE, AH, A (with BFE), VE, V1-V30, V (with BFE), AR, AR/A, AR/AE, AR/A1-A30, AR/AH, AR/AO. Complete Items C2.a-h below according to the building diagram specified in Item A7. Use the same datum as the BFE.  
 Benchmark Utilized \_\_\_\_\_ Vertical Datum NAVD 88  
 Conversion/Comments \_\_\_\_\_

Check the measurement used.

a) Top of bottom floor (including basement, crawlspace, or enclosure floor) <u>694.2</u>	☑ feet <input type="checkbox"/> meters (Puerto Rico only)
b) Top of the next higher floor <u>696.2</u>	☑ feet <input type="checkbox"/> meters (Puerto Rico only)
c) Bottom of the lowest horizontal structural member (V Zones only) _____	<input type="checkbox"/> feet <input type="checkbox"/> meters (Puerto Rico only)
d) Attached garage (top of slab) _____	<input type="checkbox"/> feet <input type="checkbox"/> meters (Puerto Rico only)
e) Lowest elevation of machinery or equipment servicing the building (Describe type of equipment and location in Comments) <u>696.2</u>	☑ feet <input type="checkbox"/> meters (Puerto Rico only)
f) Lowest adjacent (finished) grade next to building (LAG) <u>694.2</u>	☑ feet <input type="checkbox"/> meters (Puerto Rico only)
g) Highest adjacent (finished) grade next to building (HAG) <u>694.5</u>	☑ feet <input type="checkbox"/> meters (Puerto Rico only)
h) Lowest adjacent grade at lowest elevation of deck or stairs, including structural support <u>694.2</u>	☑ feet <input type="checkbox"/> meters (Puerto Rico only)

---

**SECTION D - SURVEYOR, ENGINEER, OR ARCHITECT CERTIFICATION**

This certification is to be signed and sealed by a land surveyor, engineer, or architect authorized by law to certify elevation information. I certify that the information on this Certificate represents my best efforts to interpret the data available. I understand that any false statement may be punishable by fine or imprisonment under 18 U.S. Code, Section 1001.

Check here if comments are provided on back of form. Were latitude and longitude in Section A provided by a licensed land surveyor?  Yes  No

Certifier's Name <u>Jane Q. Engineer</u>	License Number <u>5555555</u>
Title <u>Project Engineer</u>	Company Name <u>Engineering Co, Inc</u>
Address <u>555 Main Street</u>	City <u>Springfield</u> State <u>IA</u> ZIP Code <u>55555</u>
Signature _____	Date _____ Telephone <u>555-555-5555</u>

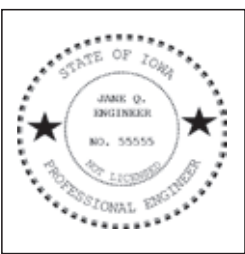

---

FEMA Form 81-31, Mar 09

See reverse side for continuation.

Replaces all previous editions

Figure 6-13. Elevation certificate excerpt for the Truman house

LINN COUNTY ASSESSOR				
Pin	55555-55555-55555			
Deed	TRUMAN HARRY S			
Property Address	55555 CEDAR RIVER RD MT VERNON			
Class	RESIDENTIAL			
Current Value Information				
Land Value	Dwelling Value	Improvement Value	Total Value	
1,434,098	163,795	0	1,597,893	
Prior Year Value Information				
Year	Land Value	Dwelling Value	Improvement Value	Total Value
2011	1,434,098	163,795	0	1,597,893
2010	1,434,098	163,795	0	1,597,893
2009	1,434,098	163,795	0	1,597,893
2008	1,434,098	163,795	0	1,597,893
2007	1,434,098	163,795	0	1,597,893
Residential Building Information				
Occupancy	Style	Year Built	Total Living Area	
Single-Family/Owner Occupied	1 Story Frame	1964	1,800	
Yard Extra Information				
Description	Item Count	Year Built		
NA				
Land Information				
Lot Basis	Square Feet	Acres		
Lump Sum	9,280,000	213		
Tax History Information				
Tax Year	Assessed Value	Taxable Value	Gross Tax	Net Tax
2009	1,597,893	748,564	23,363	23,363
2008	1,597,893	728,462	20,791	20,600
2007	1,597,893	704,354	20,244	19,200
2006	1,356,789	618,145	17,533	17,000

Figure 6-14. Truman house tax card



16 Sep 2011	Project: <b>Case Study 1</b>	Pg 1 of 21
Total Benefits: <b>\$246,241</b>	Total Costs: <b>\$220,000</b>	BCR: <span style="border: 1px solid black; padding: 2px;">1.12</span>
Project Number:	Disaster #:	Program:
State: <b>Iowa</b>	Point of Contact: Harry Truman	Agency: <b>City of Mount Vernon</b>
		Analyst:

**Project Summary:**

Project Number: \_\_\_\_\_ Disaster #: \_\_\_\_\_  
 Program: \_\_\_\_\_ Agency: City of Mount Vernon  
 Analyst: \_\_\_\_\_

Point of Contact: Harry Truman Phone Number: \_\_\_\_\_  
 Address: 55555 Cedar River Rd, Mount Vernon, Iowa, 55555  
 Email: \_\_\_\_\_  
 Comments: \_\_\_\_\_

**Structure Summary For:**

1-Elevation, 55555 Cedar River Road, Mount Vernon, Iowa, 55555, Linn

Structure Type: Building Historic Building: No Contact: \_\_\_\_\_  
 Benefits: \$105,211 Costs: \$100,000 BCR: 1.05

Mitigation	Hazard	BCR	Benefits	Costs
Elevation	Flood	1.05	\$105,211	\$100,000

2-Relocation, 55555 Cedar River Road, Mount Vernon, Iowa, 55555, Linn

Structure Type: Building Historic Building: No Contact: \_\_\_\_\_  
 Benefits: \$141,030 Costs: \$120,000 BCR: 1.18

Mitigation	Hazard	BCR	Benefits	Costs
Acquisition	Flood	1.18	\$141,030	\$120,000

Figure 6-15. Sample BCA report excerpt for the Truman house elevation and relocation projects

### 6.1.6 Real World Examples

Although the Truman house is fictional, elevation and relocation are both commonly used flood mitigation measures. Figures 6-16 and 6-17 are examples of real structures that have been protected using the mitigation measures discussed in this case study.

This structure was relocated to another property.



**Figure 6-16.**  
Relocation of an existing building to another location

This home was elevated on solid foundation walls in Louisiana.



**Figure 6-17.**  
Elevation of an existing home above the BFE